



nickelodeon.  
TEENAGE MUTANT NINJA  
TURTLES™



79104



1



2



3



4



[LEGO.com/brickseparator](http://LEGO.com/brickseparator)

IMPORTANT: Never modify the elements or use other projectiles than provided with this toy.  
IMPORTANT : Ne jamais modifier les éléments ni utiliser d'autres projectiles que ceux fournis avec ce jouet.  
IMPORTANTE: No modifique los elementos ni utilice otros proyectiles diferentes a los suministrados junto con este juguete.

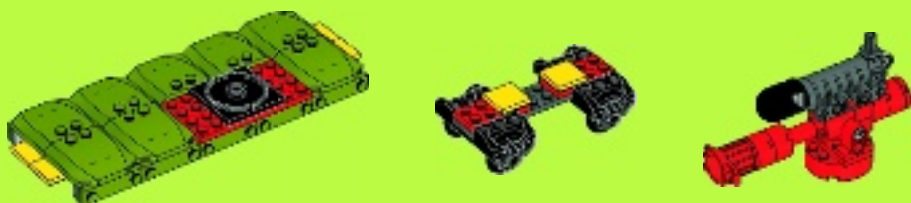
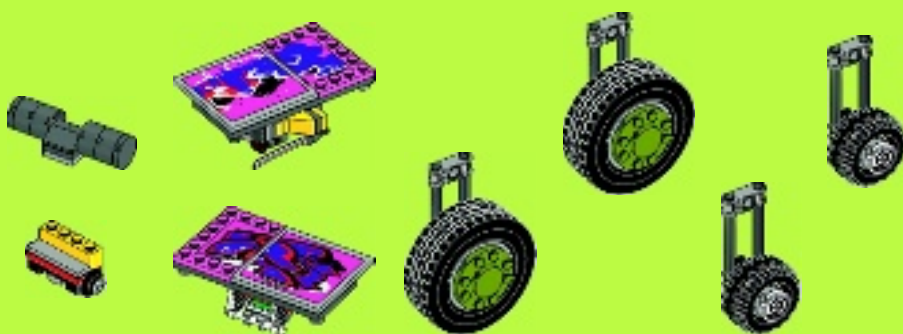
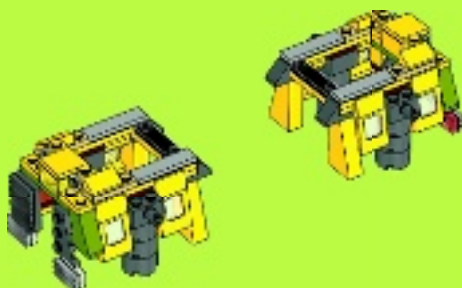
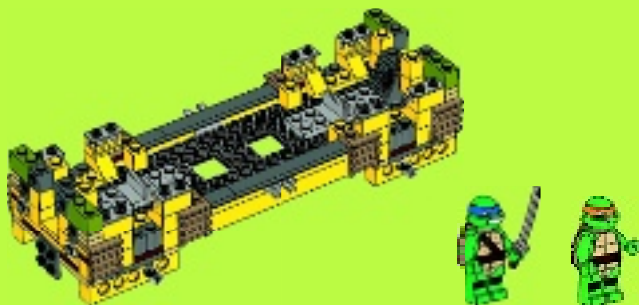

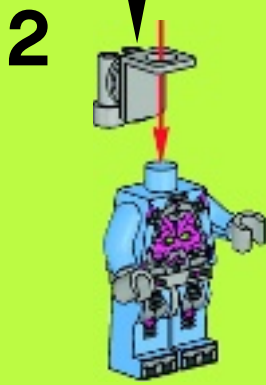
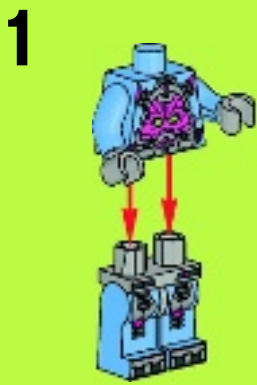
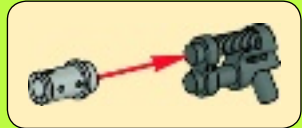
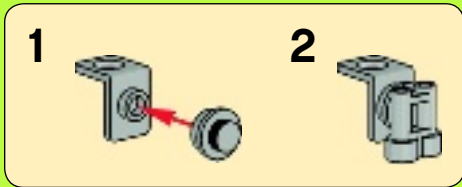
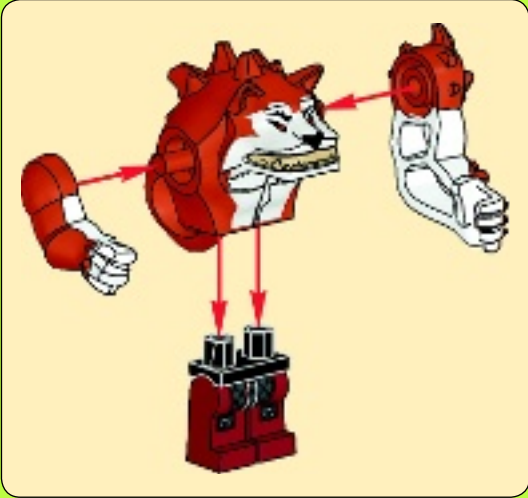



1

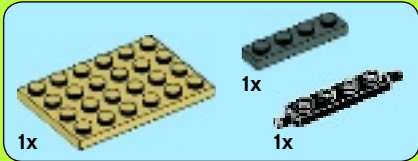

2

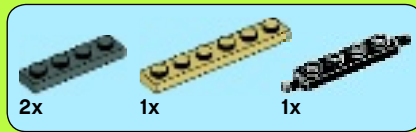

3

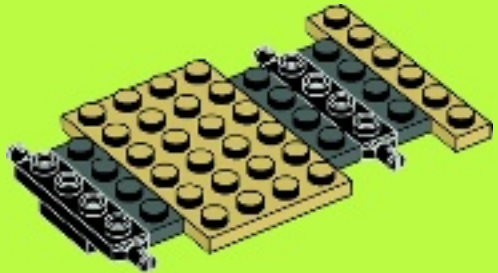

4

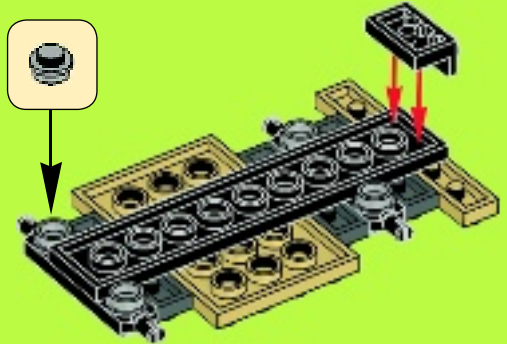

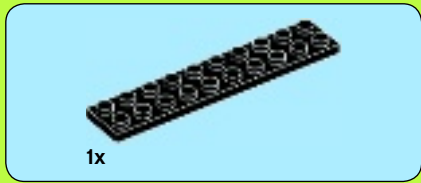

5

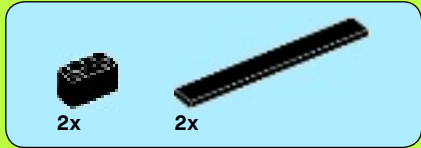
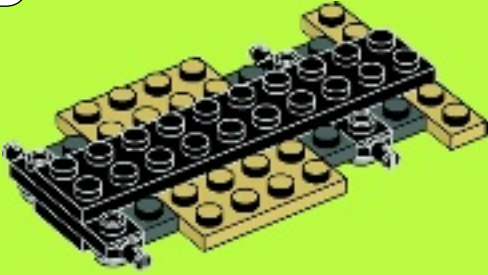

6

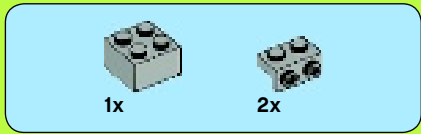
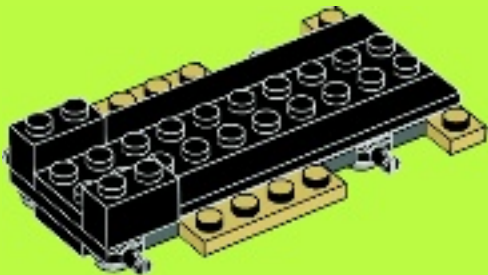

7

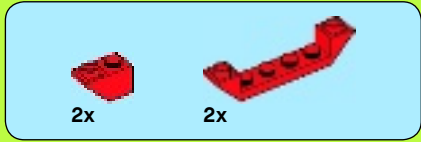
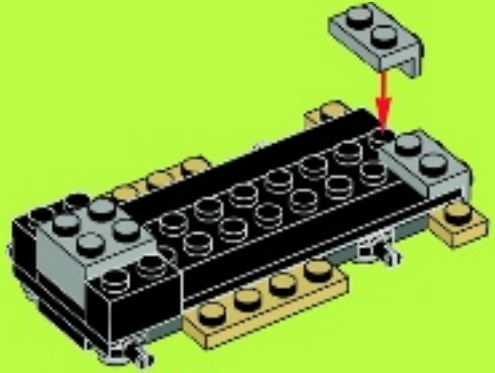

8

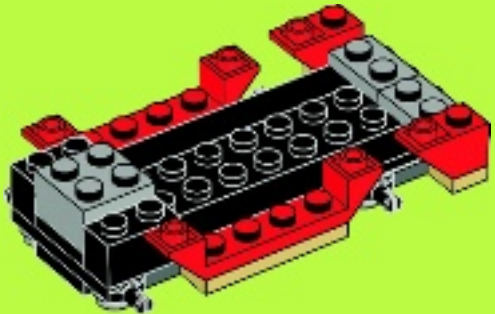



9

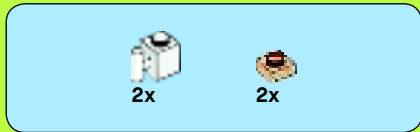
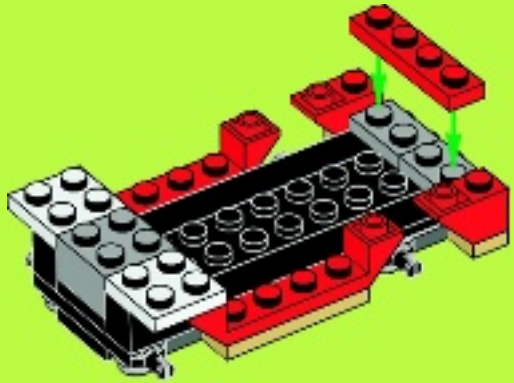

11

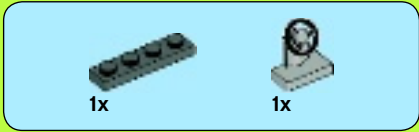
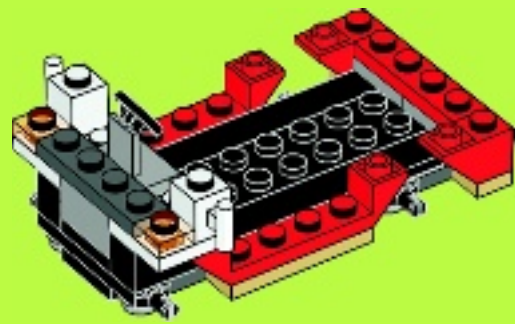

10

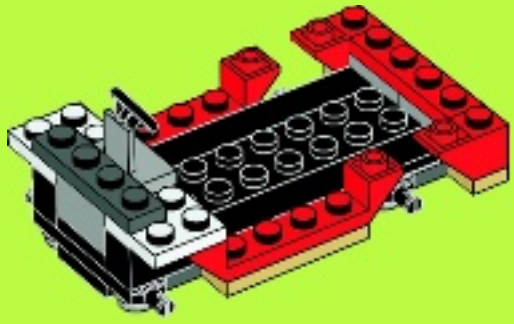

12

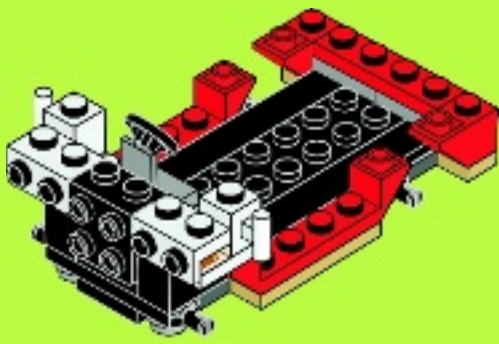



13

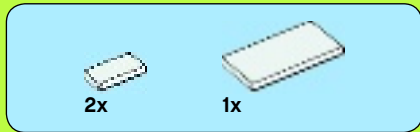
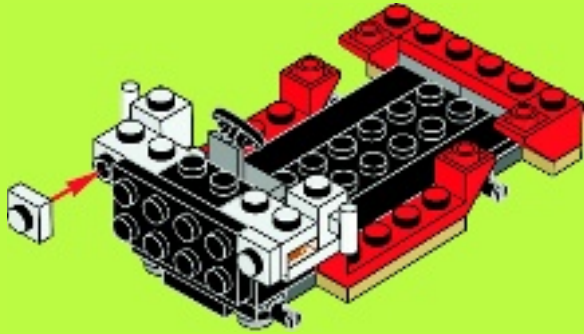

15

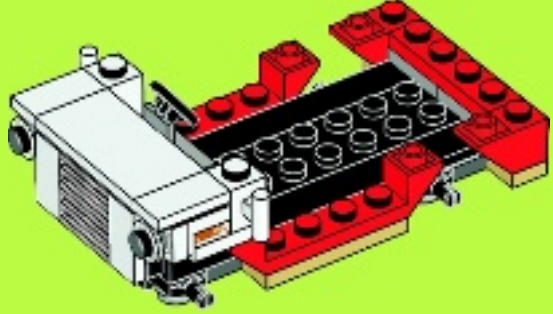

14

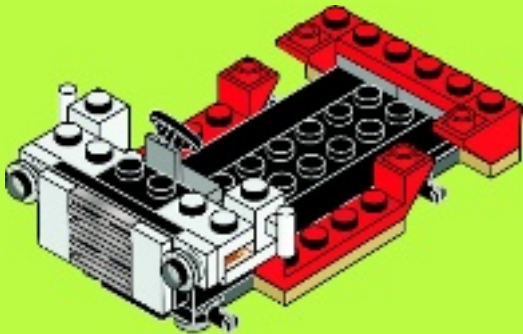

16

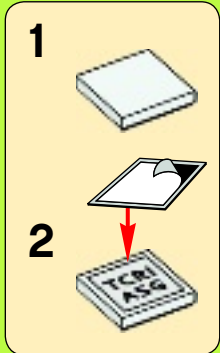





6x

# 17

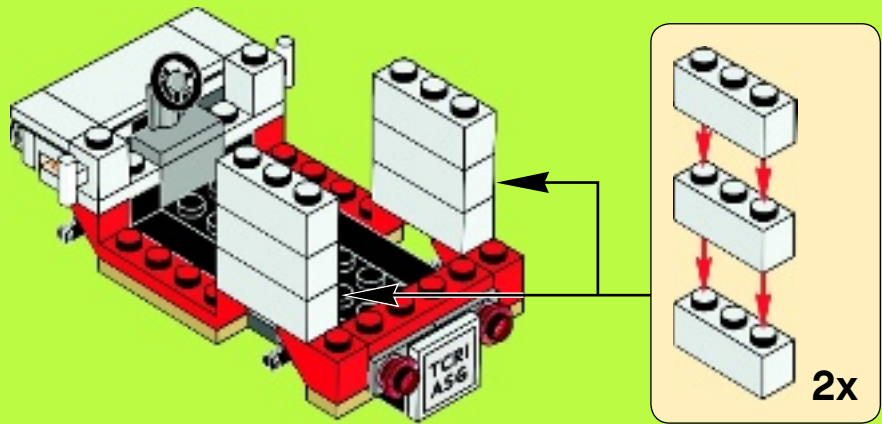

1x



1x

# 18

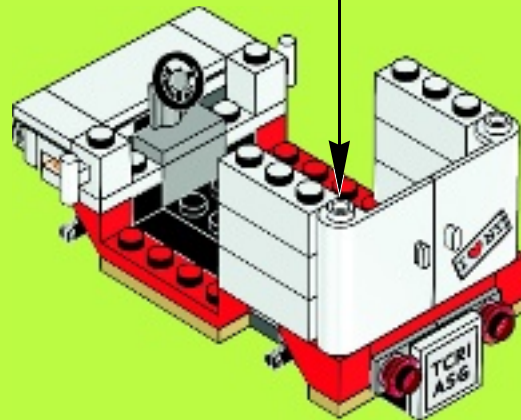
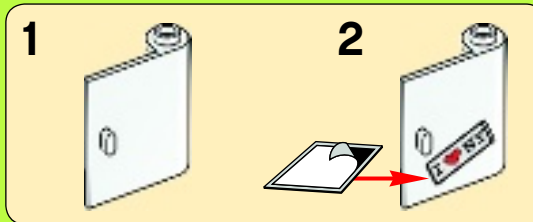



2x

# 19

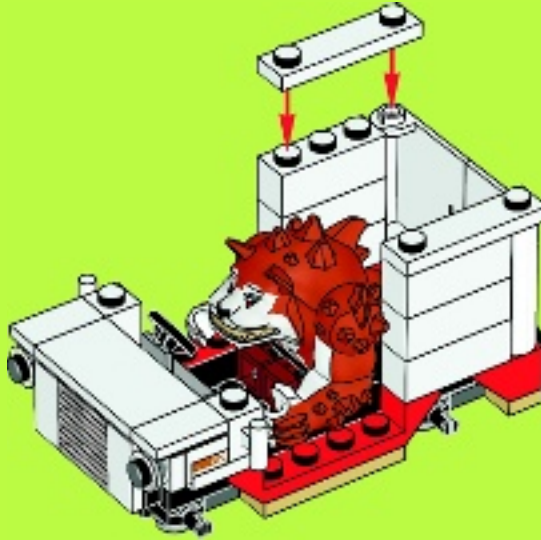

1x



1x

# 20

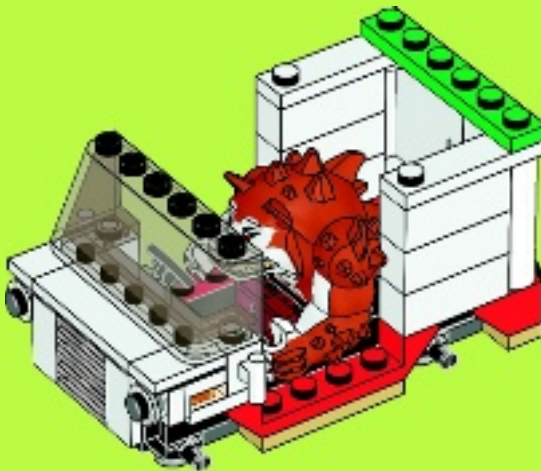

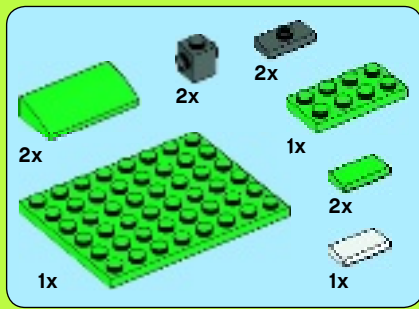

# 21

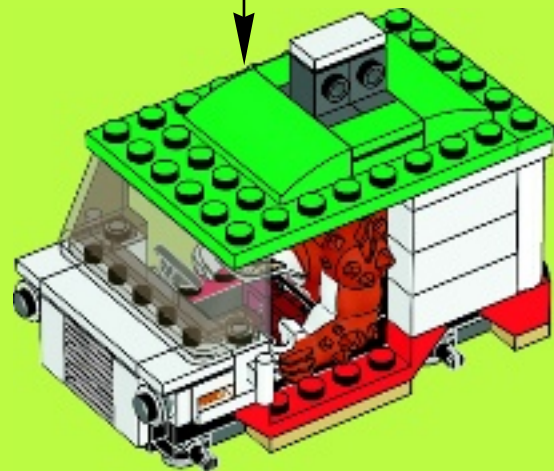
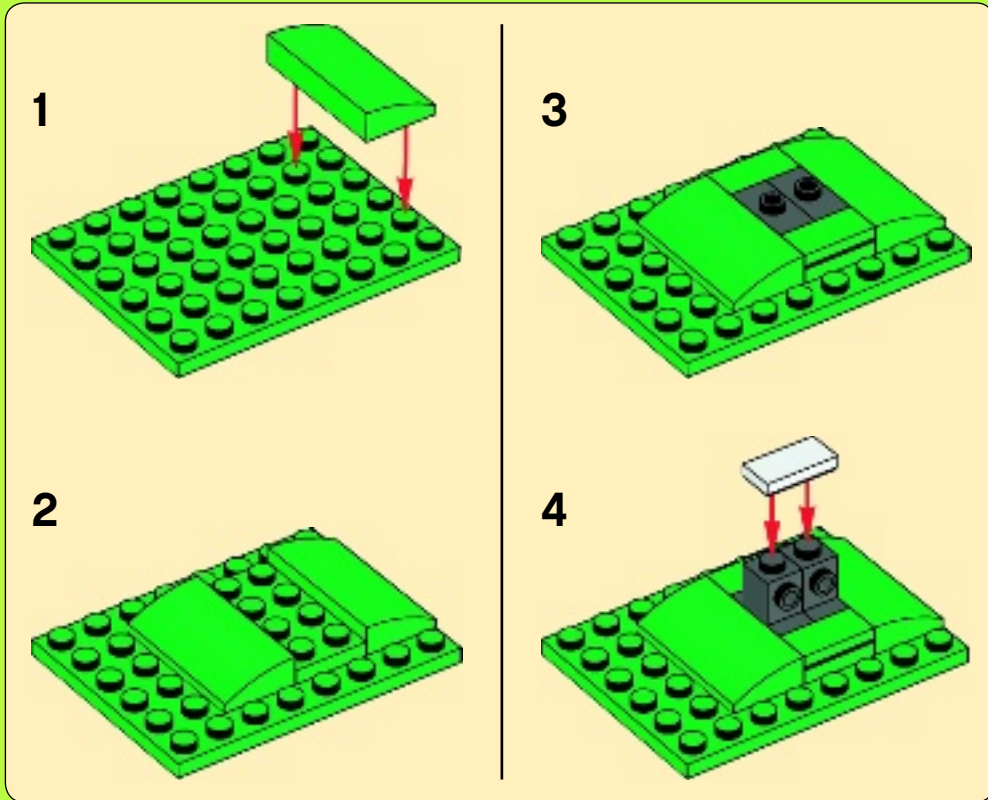

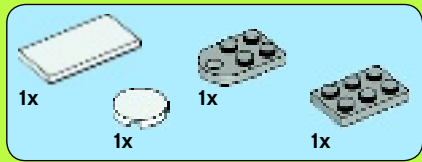

# 22

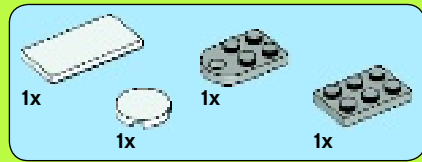
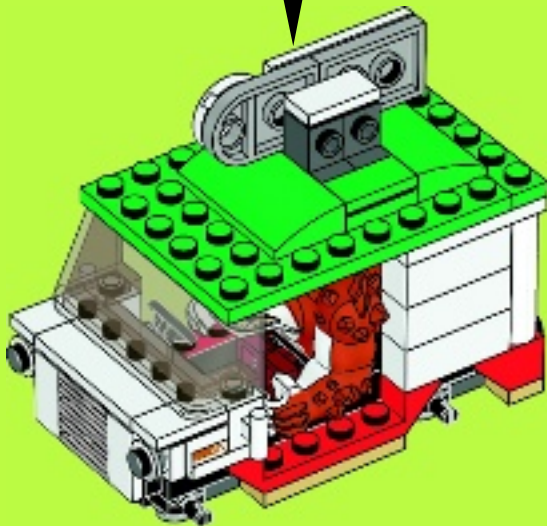
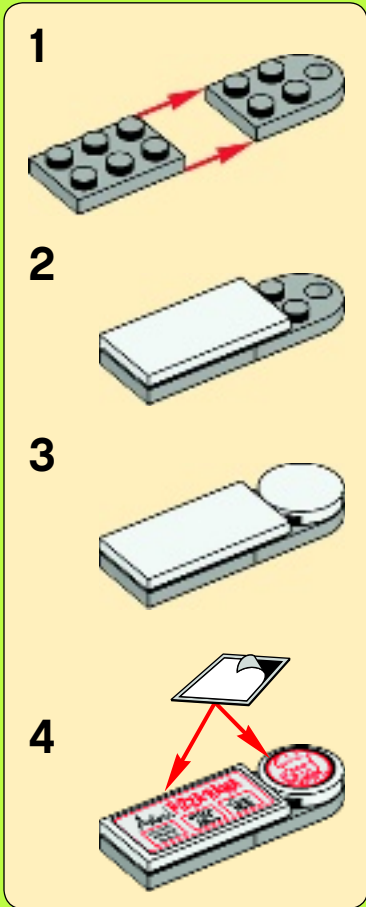

# 23

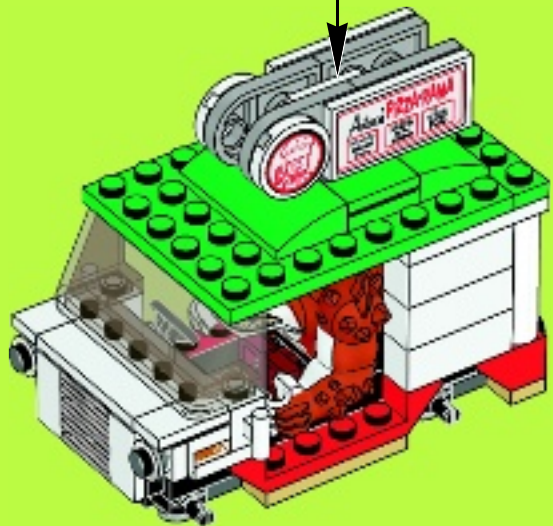
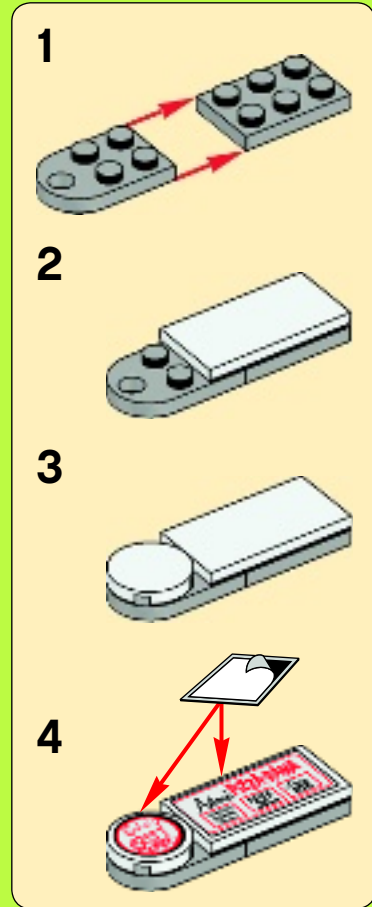



4x



4x

# 24

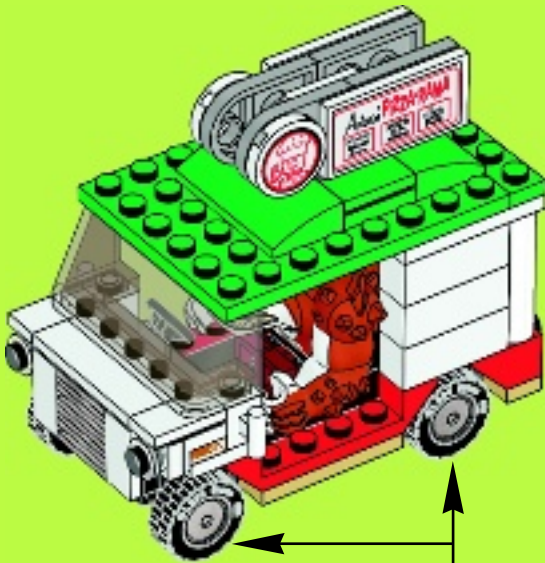

1



2



4x



2x



2x



2x

# 25

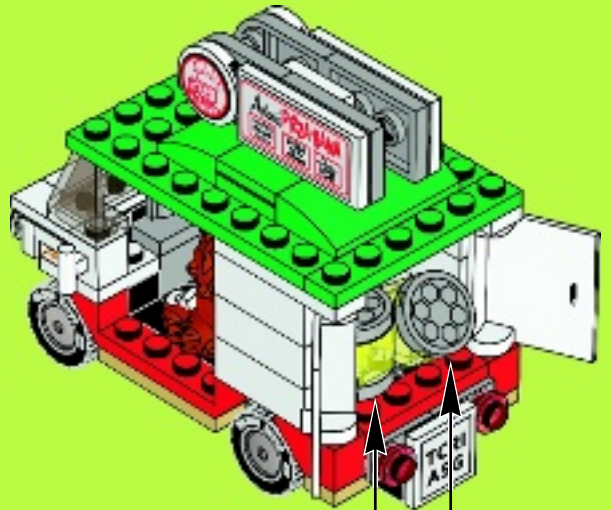

1



2



3



2x

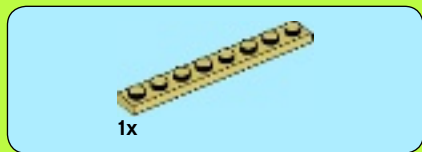
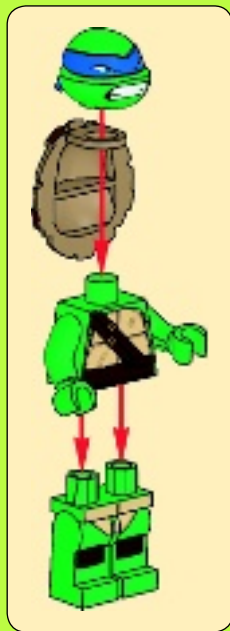
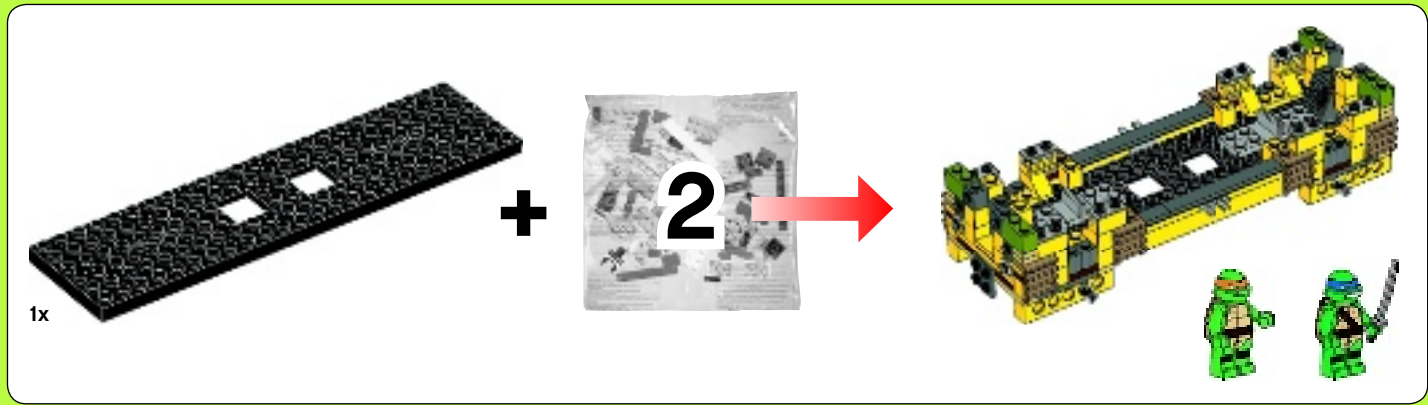

1

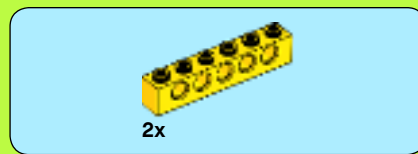
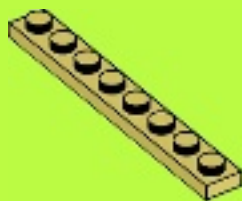

2

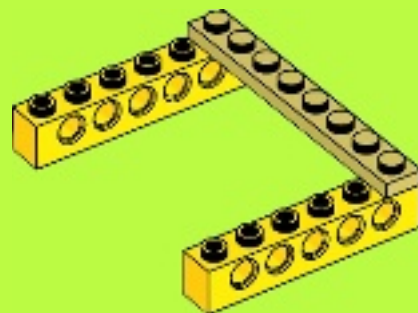

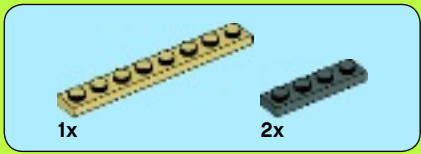

3

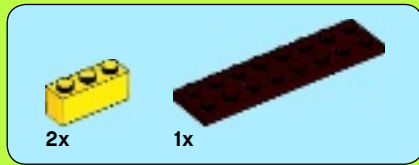
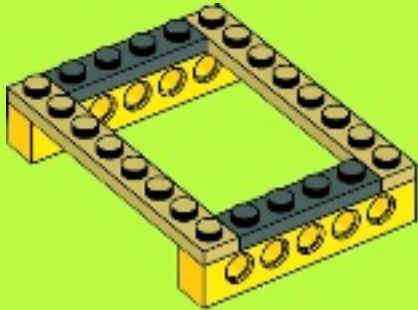

5

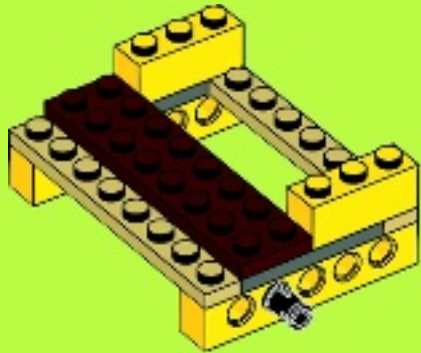

4

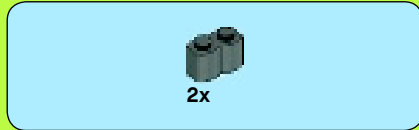
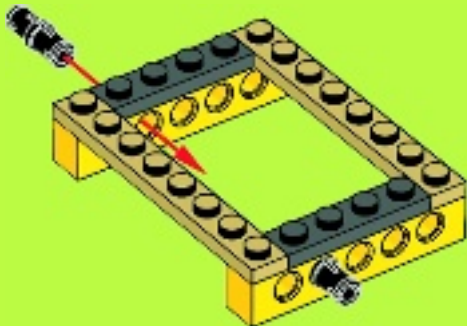

6

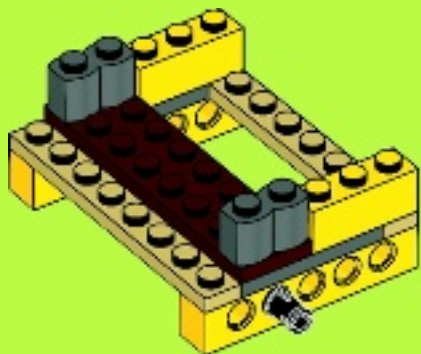

2x

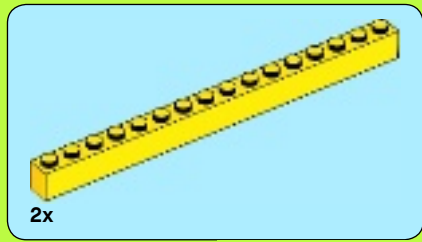

7

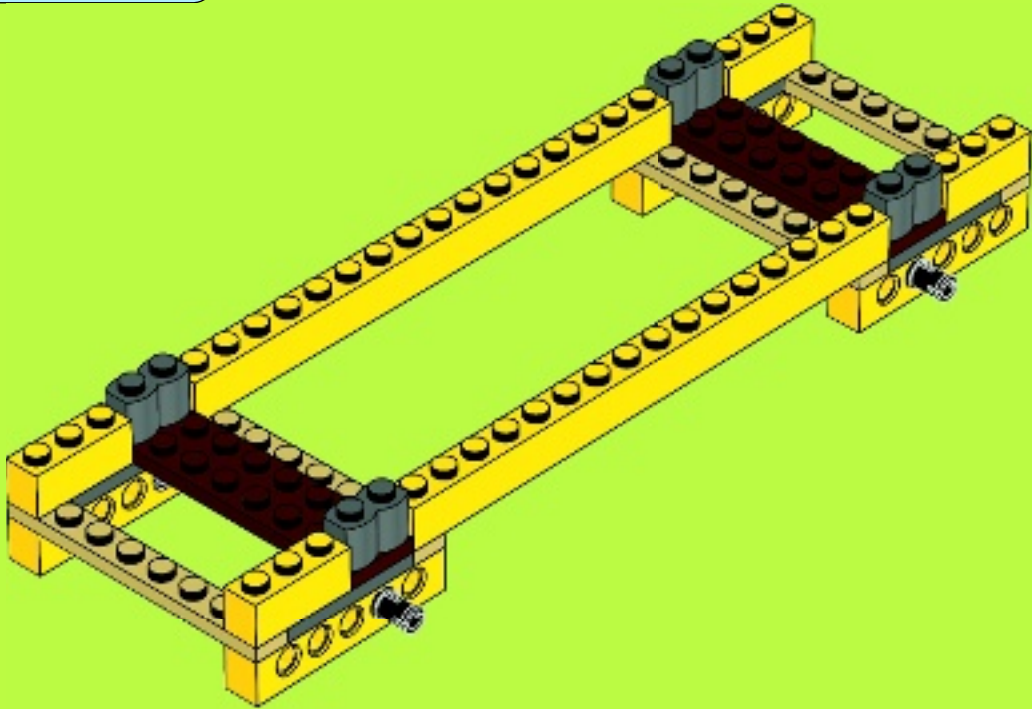

8

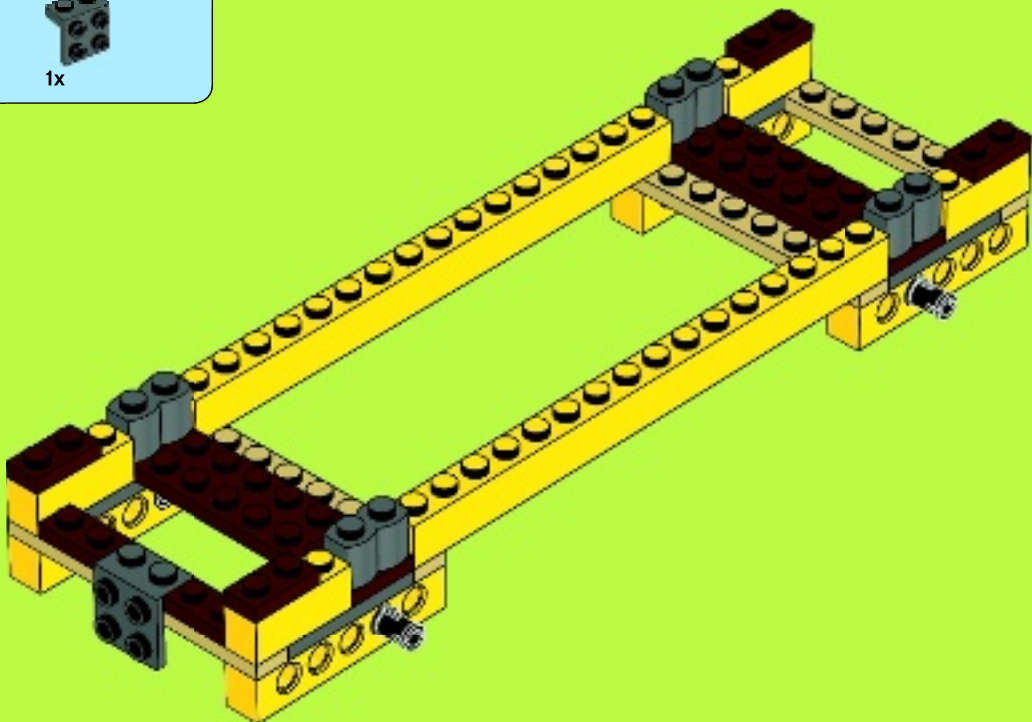





3x

# 9

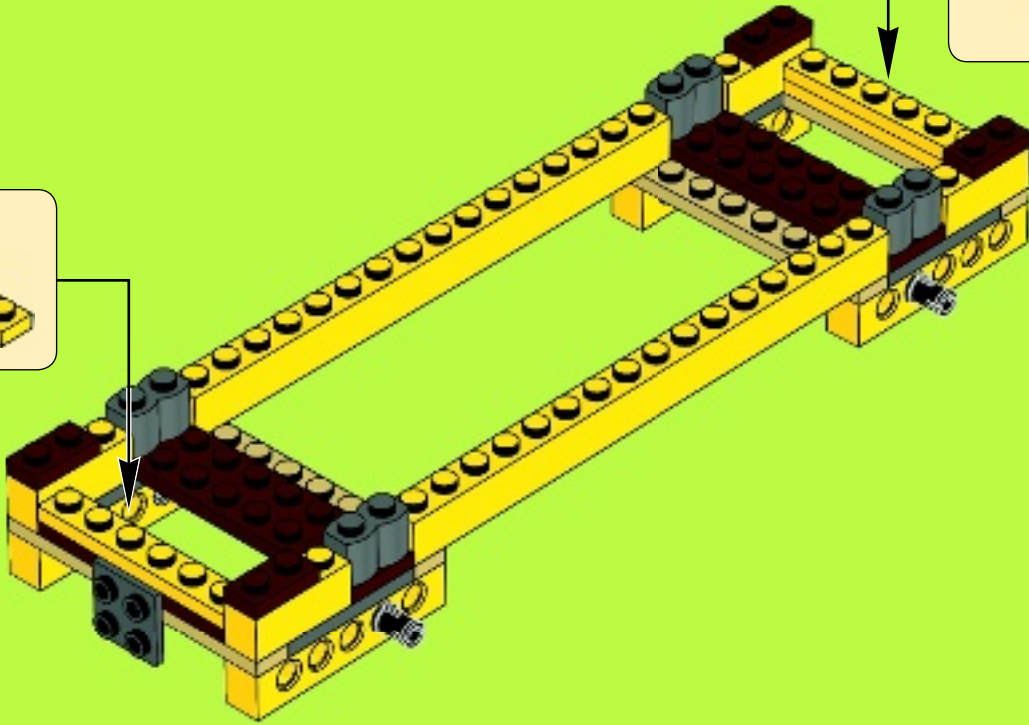
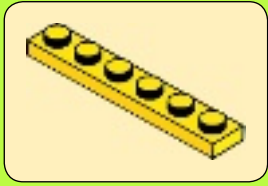
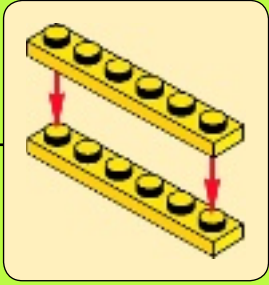

4x



4x

# 10

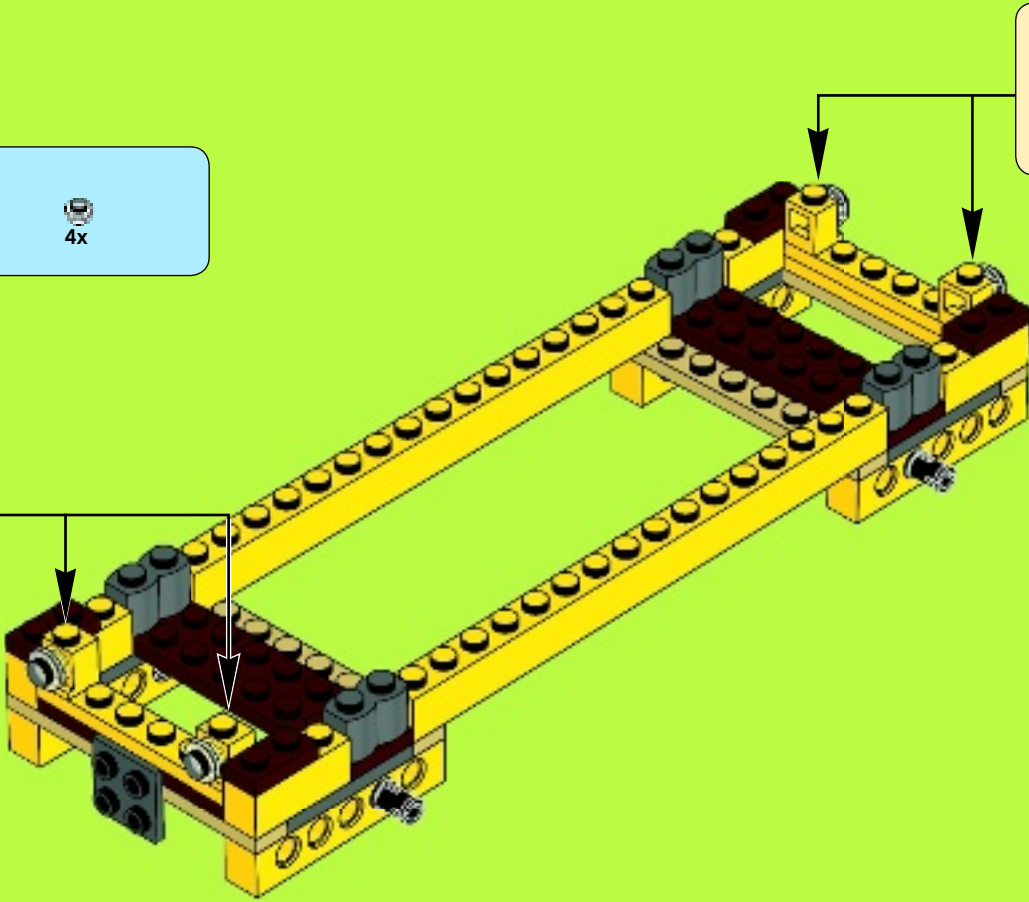
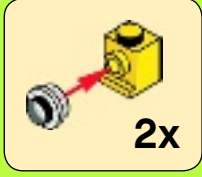
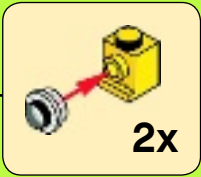

4x 4x 2x

11

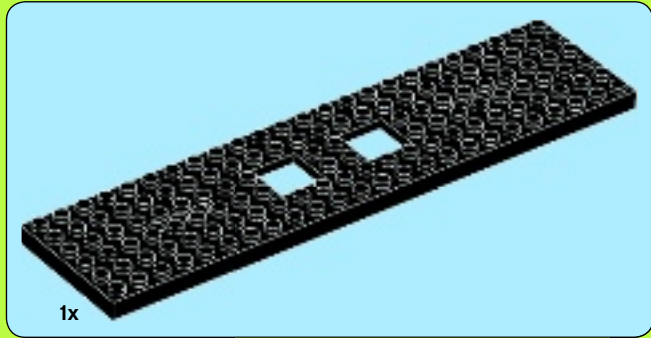
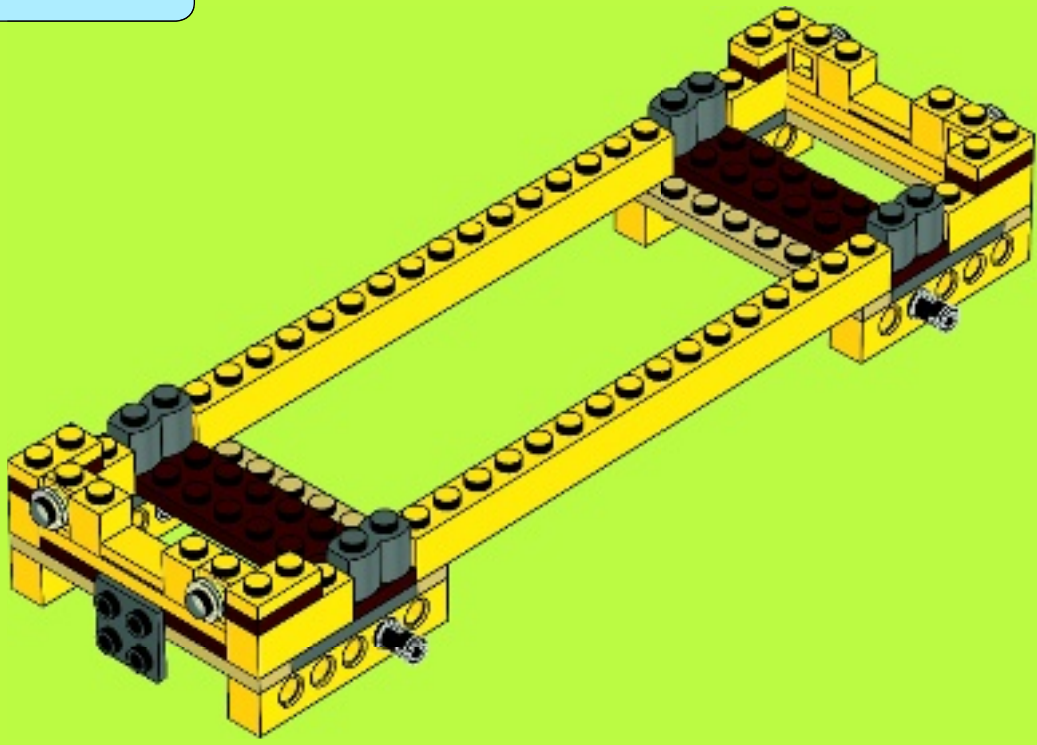

12

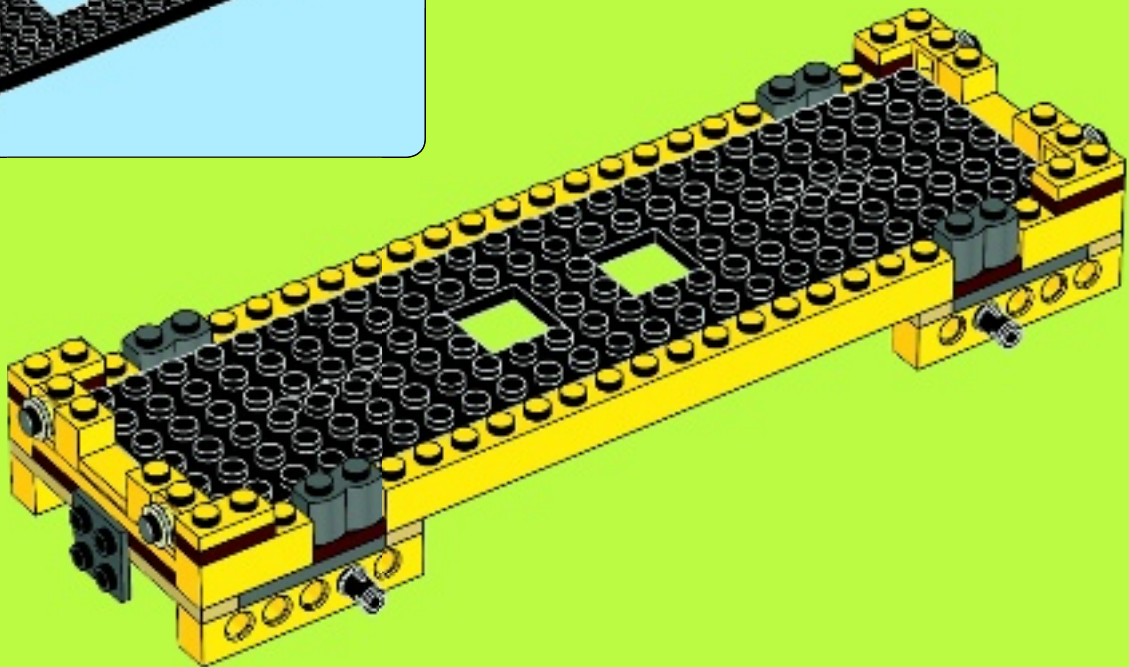



4x

# 13

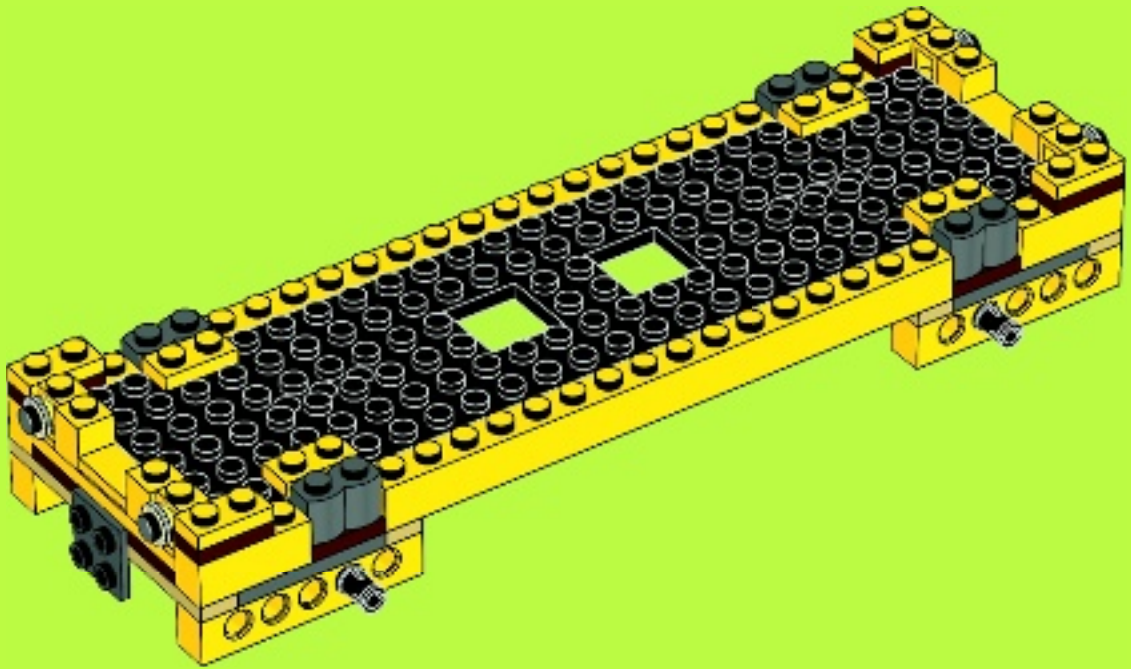

8x

# 14

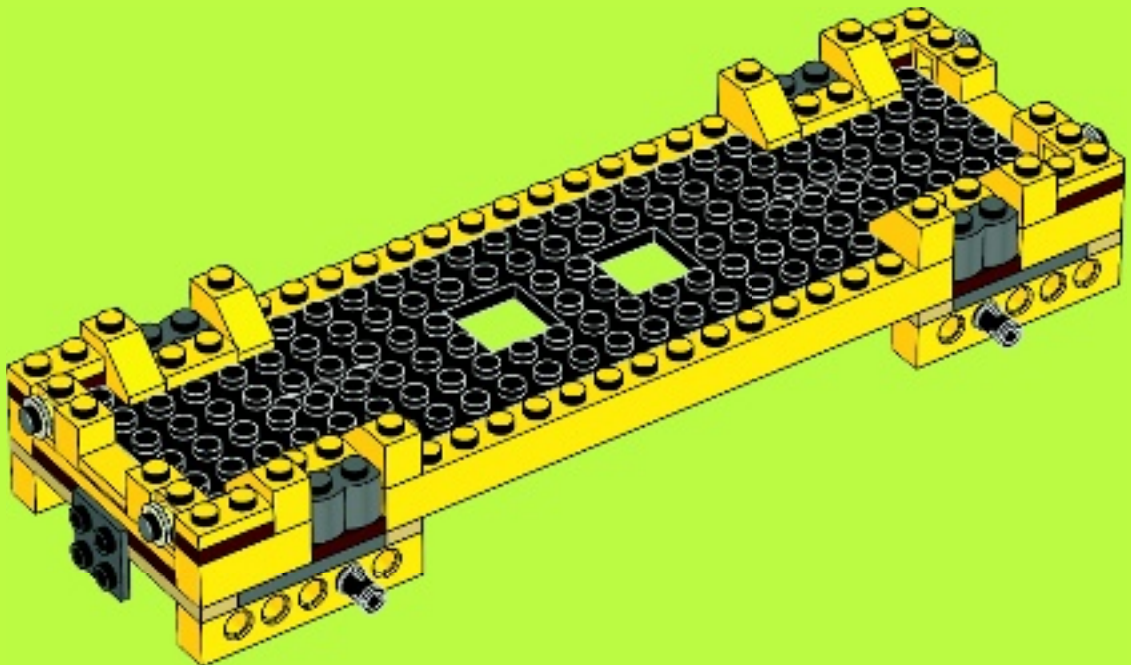

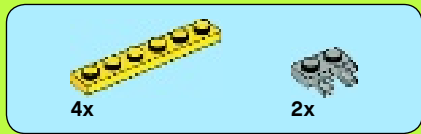

15

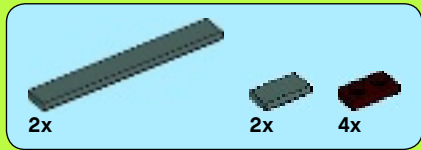
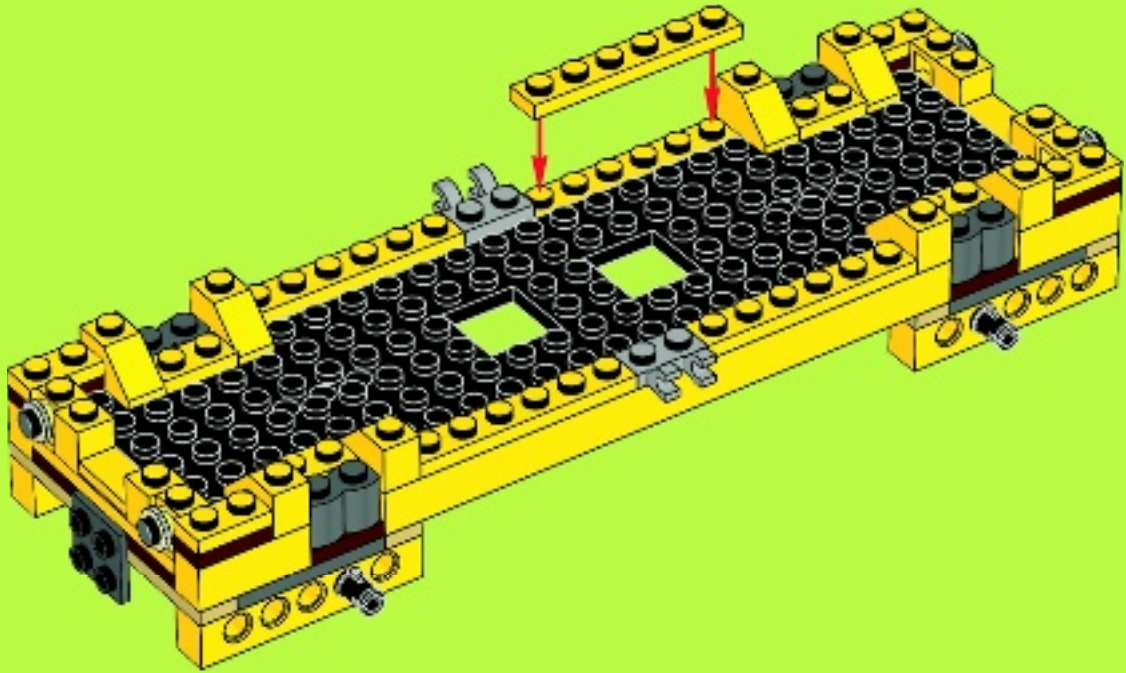

16

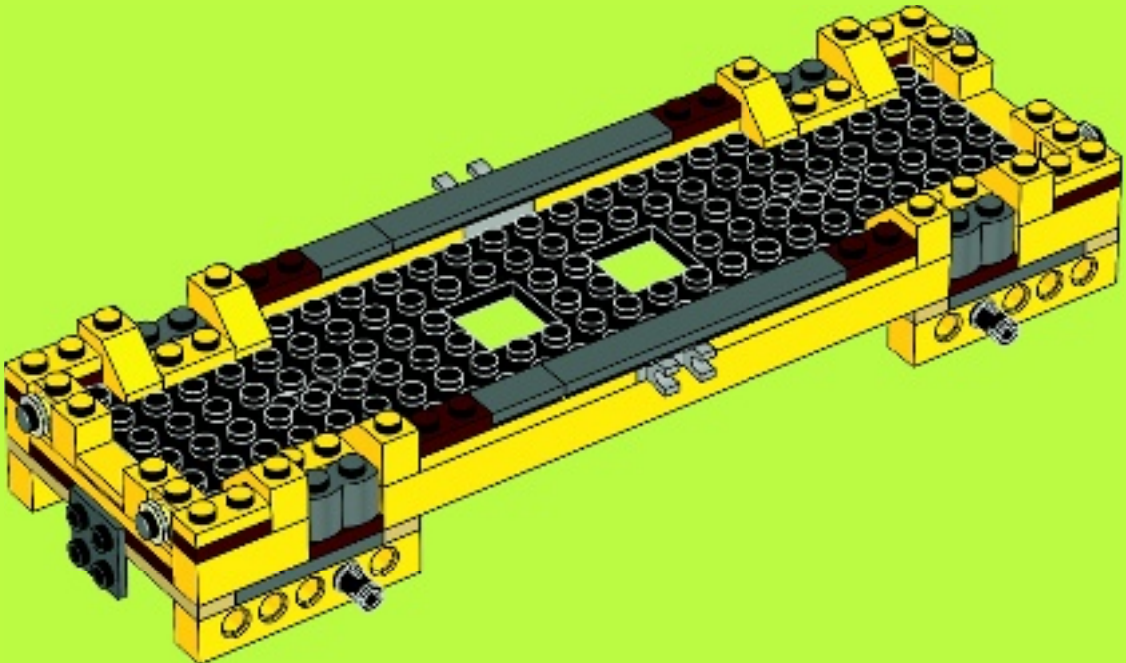



8x

# 17

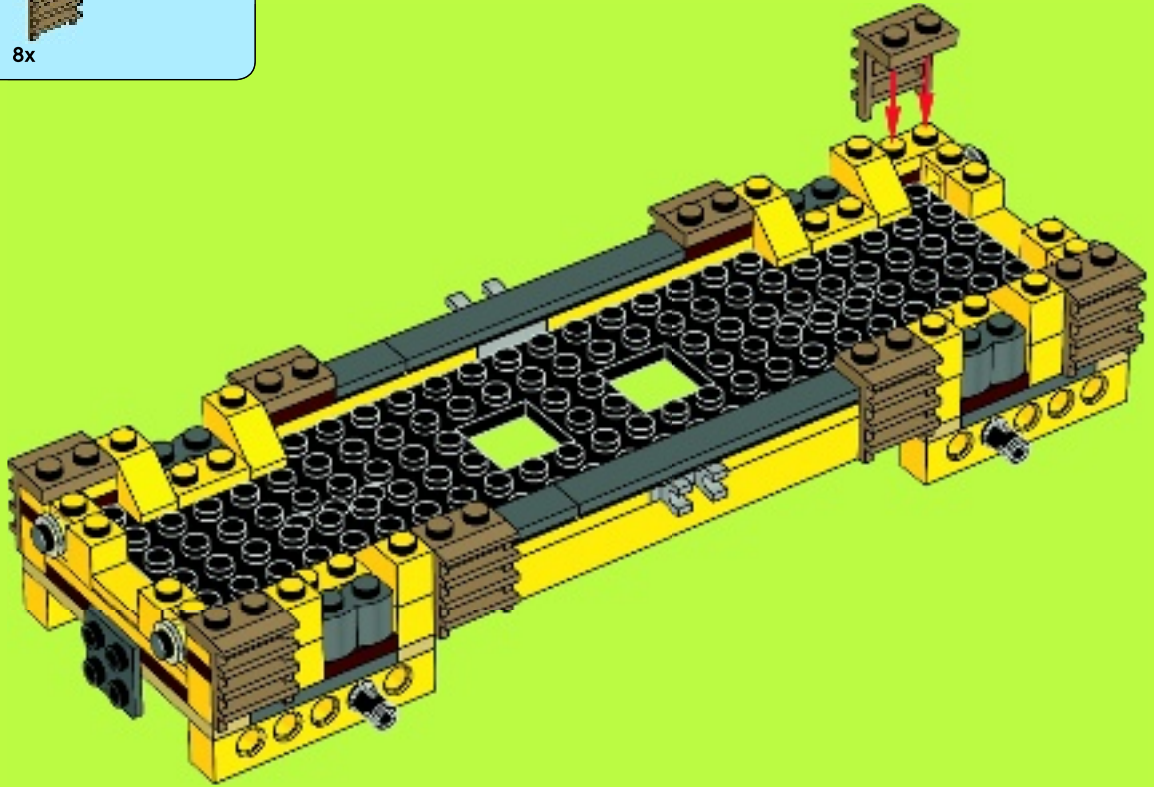

4x



8x

# 18

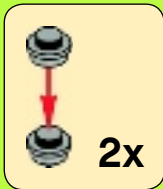

2x



2x

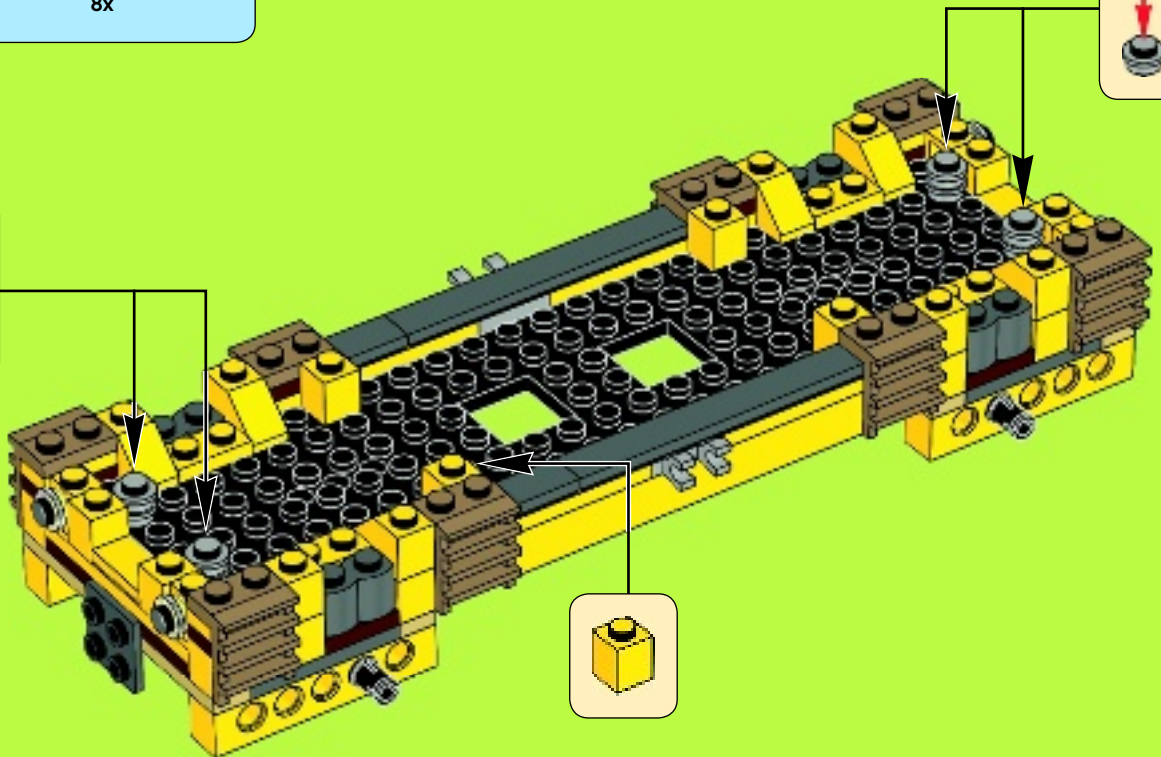



8x

# 19



2x



2x

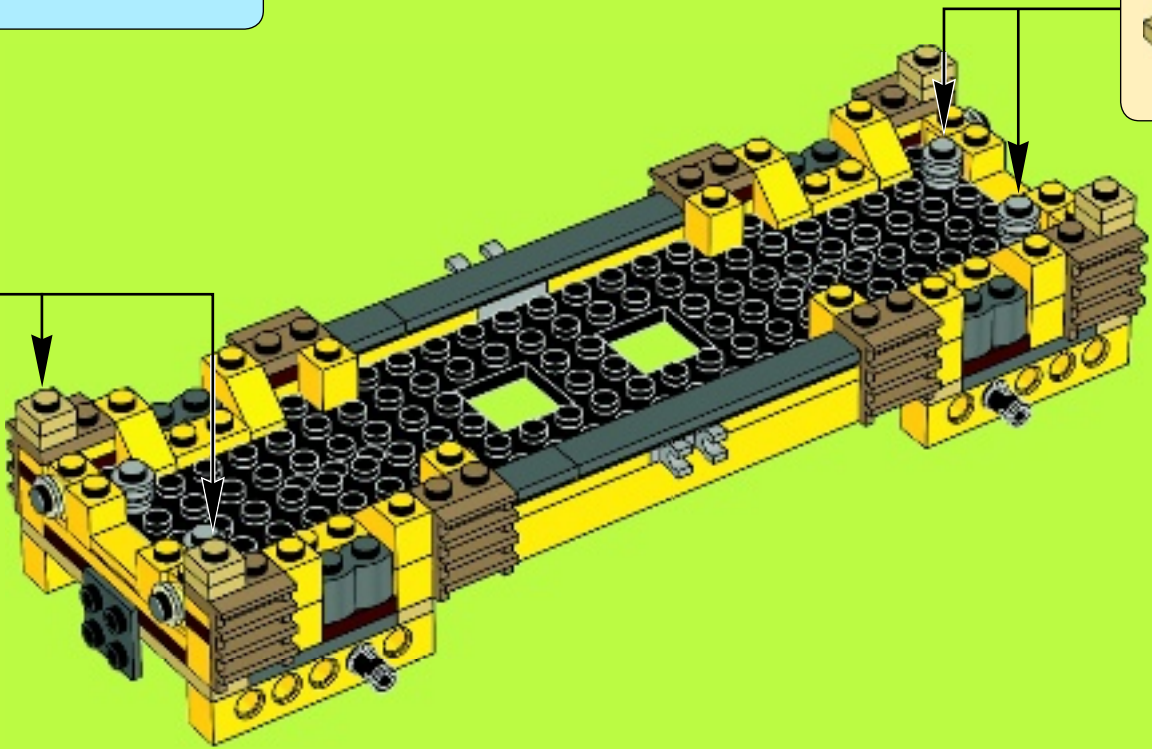

4x



4x

# 20



2x

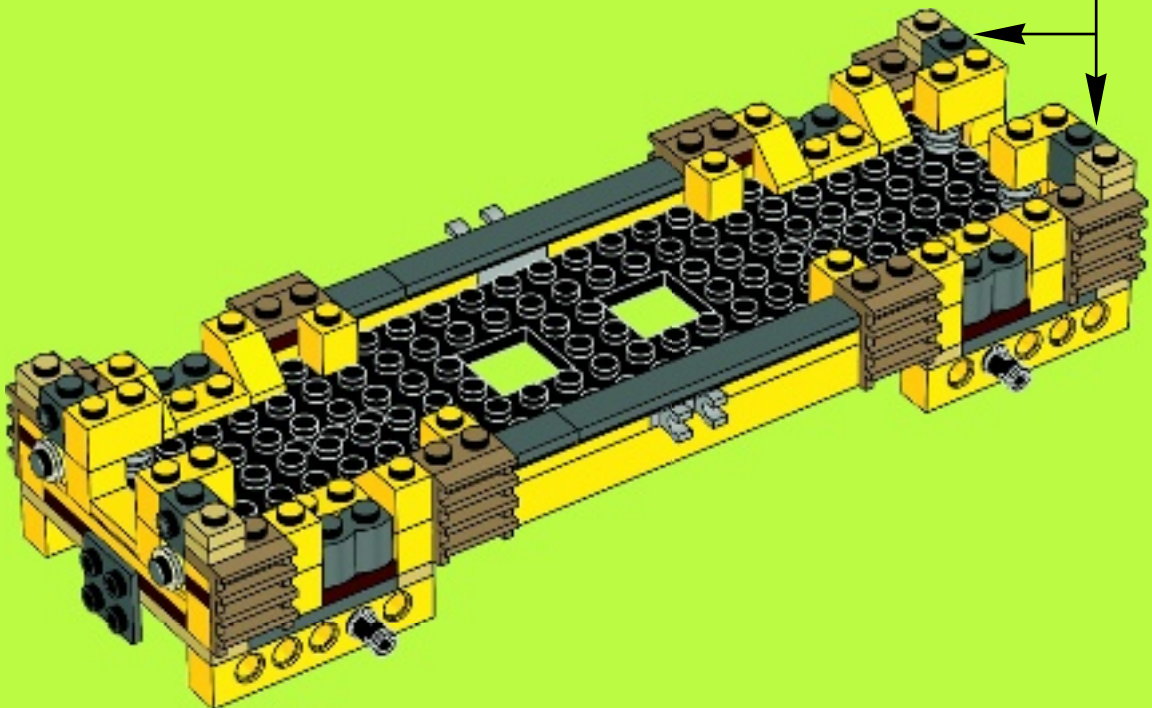

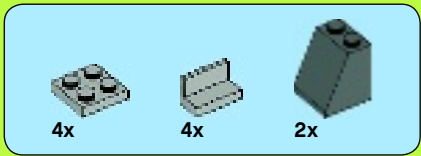

# 21

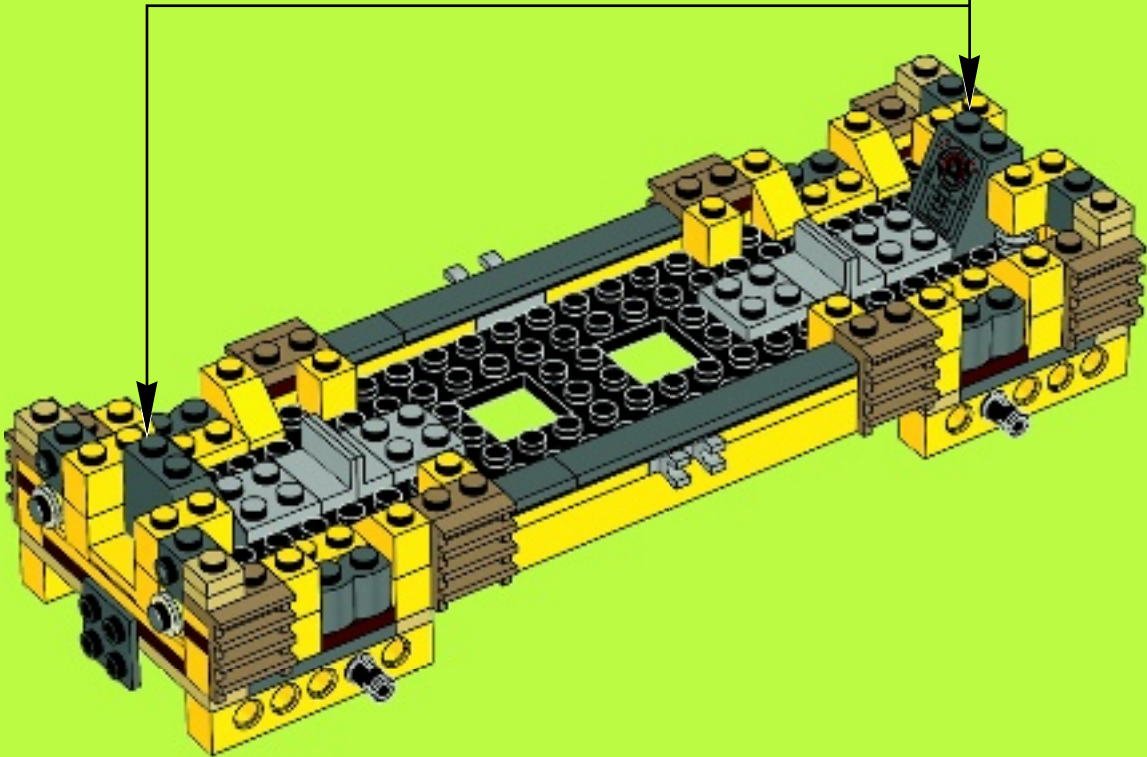
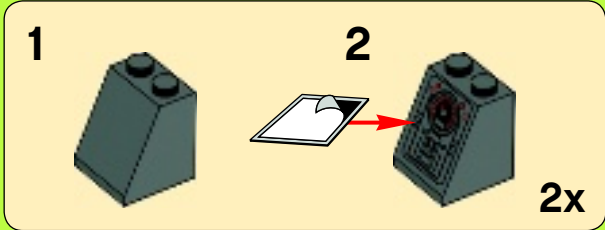

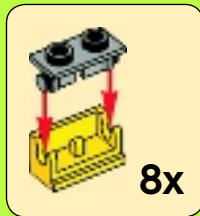

22

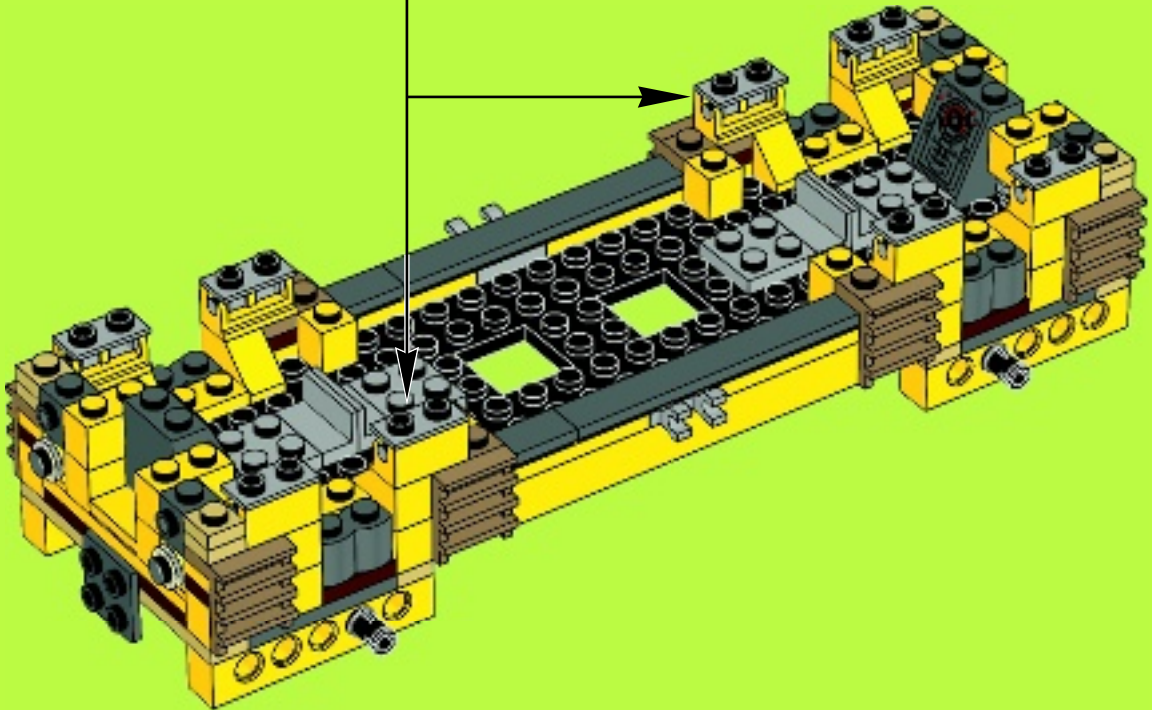

23

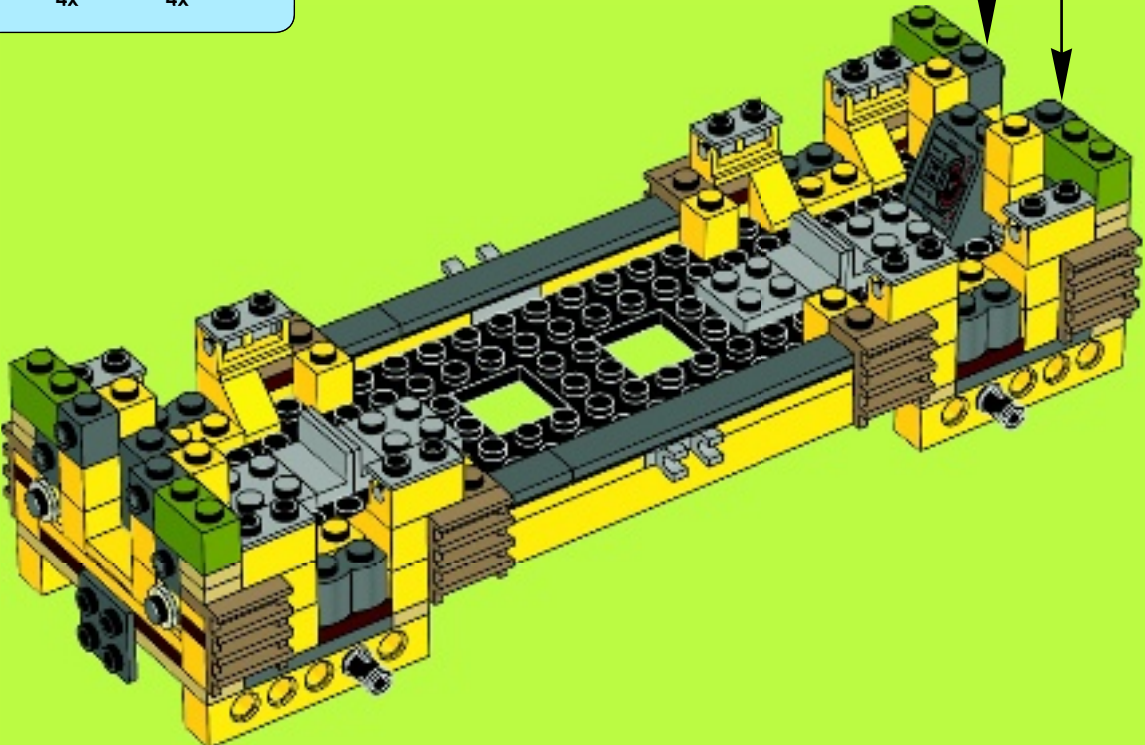



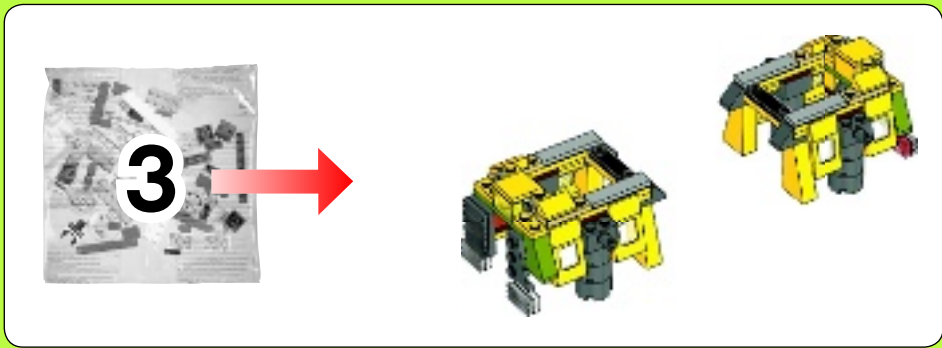

24

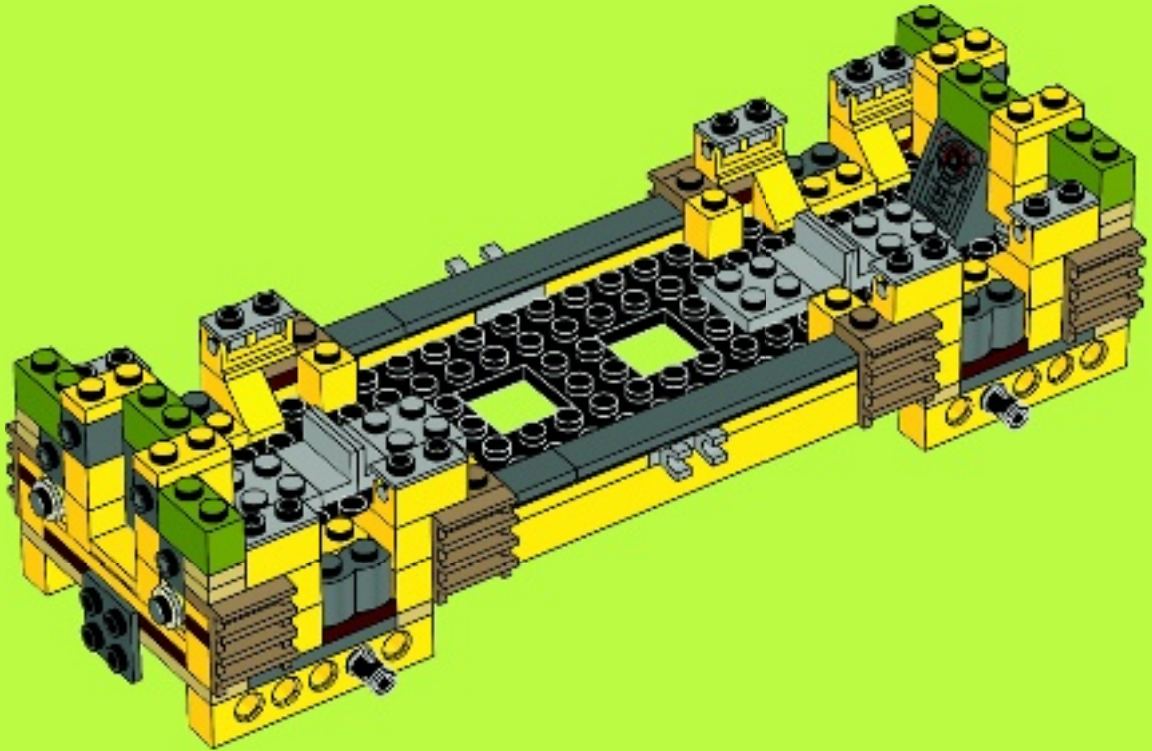

2x  4x 

# 25

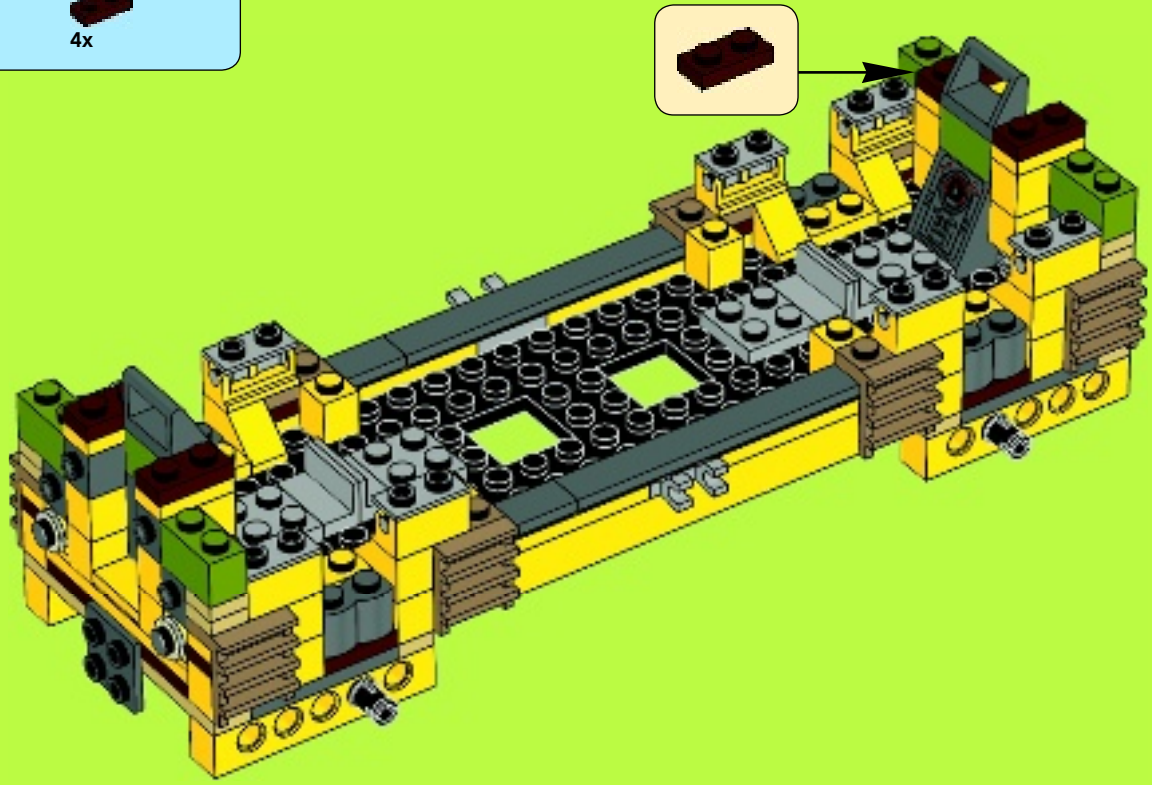

4x  4x 

# 26

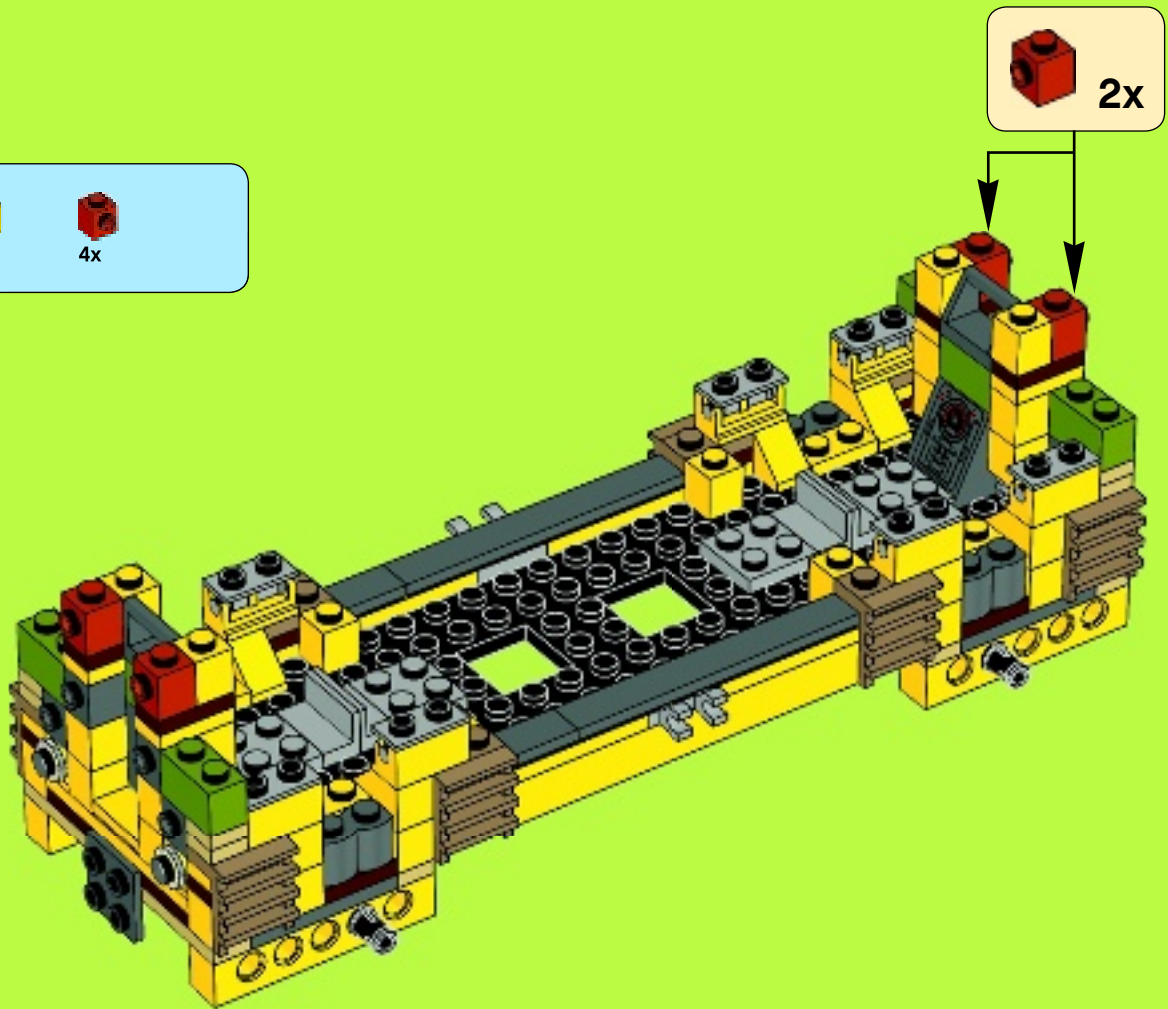



# 27

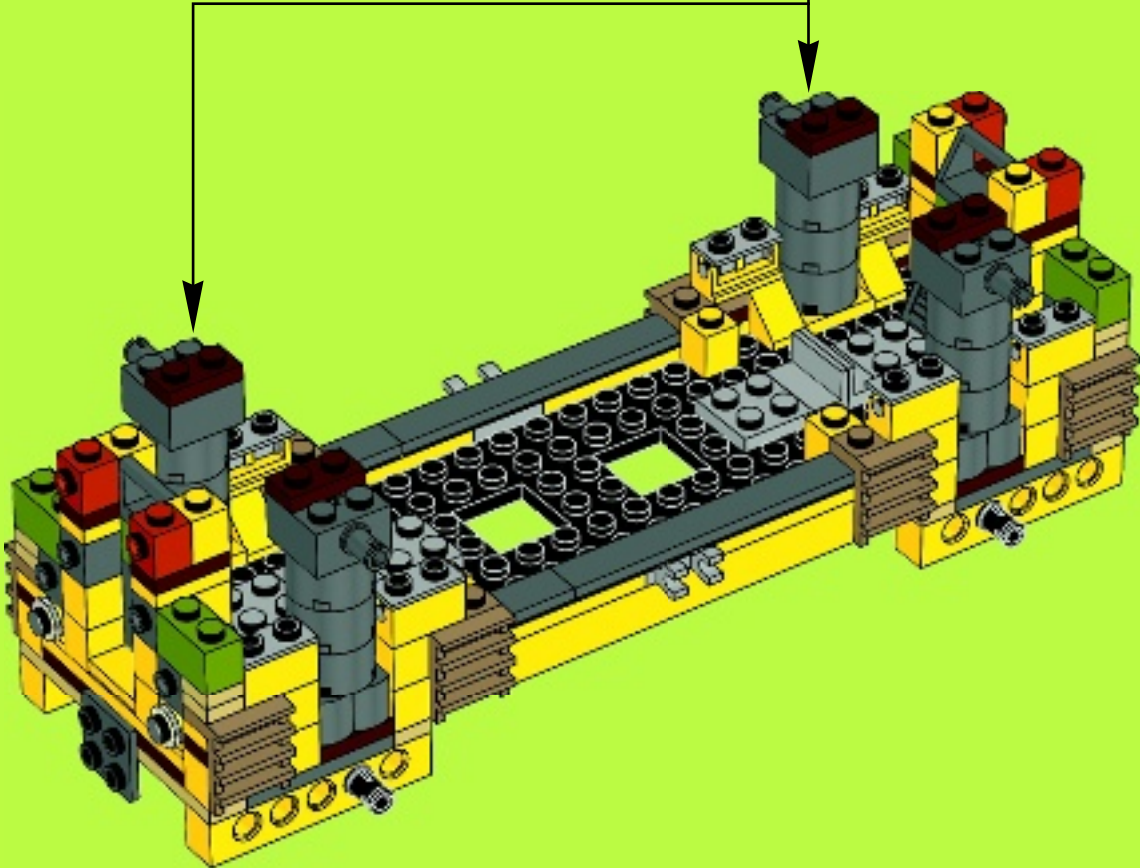
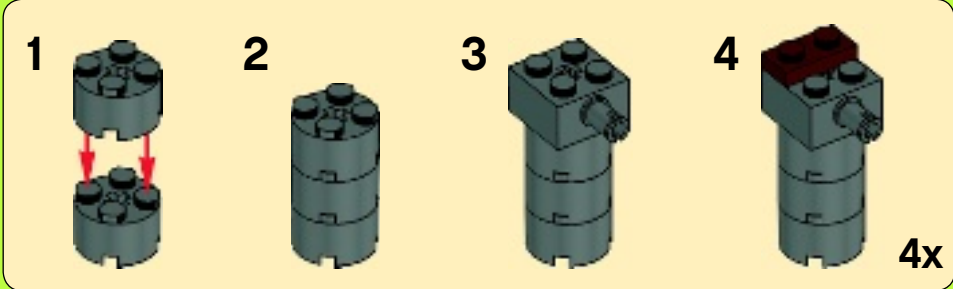



# 28

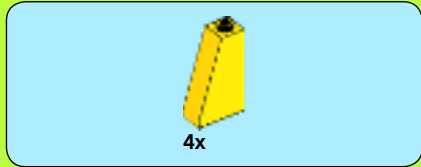
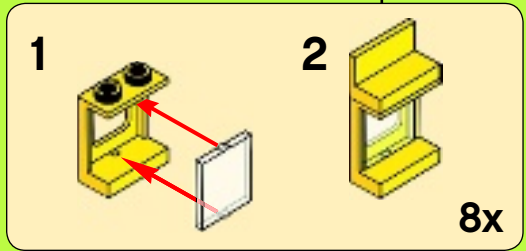
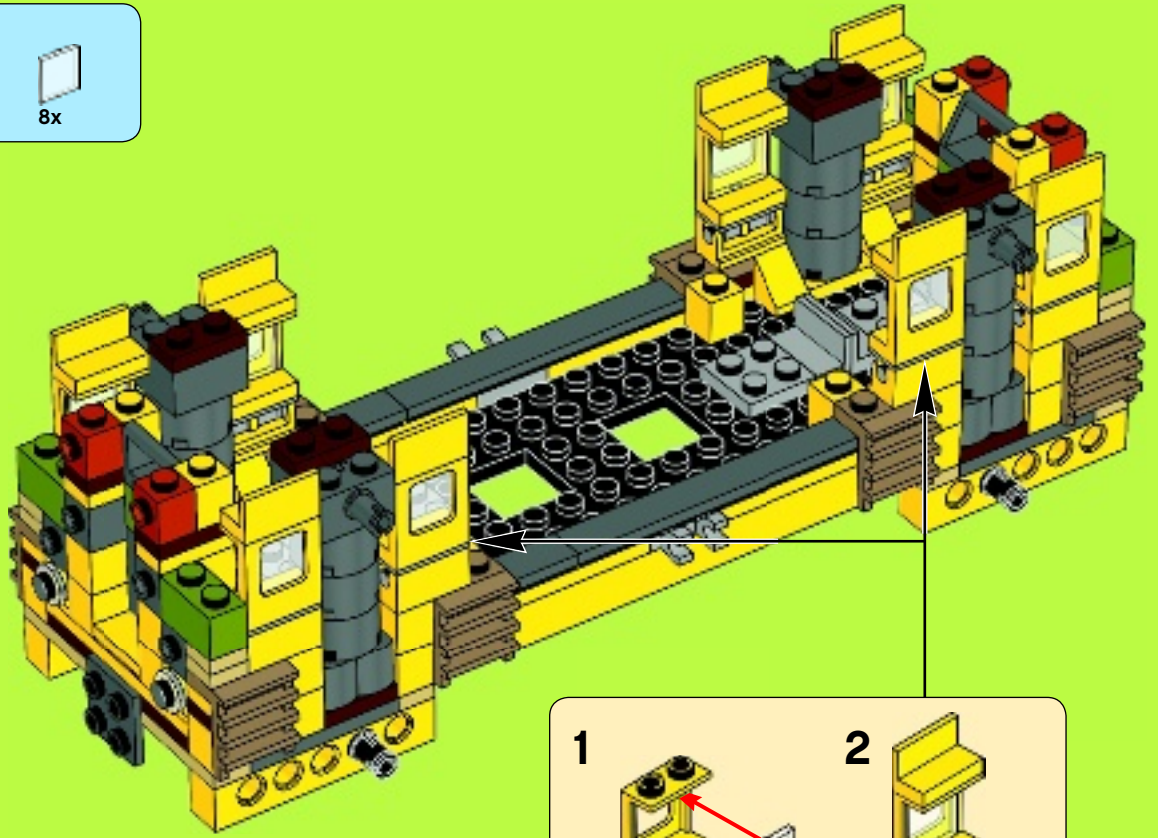

# 29

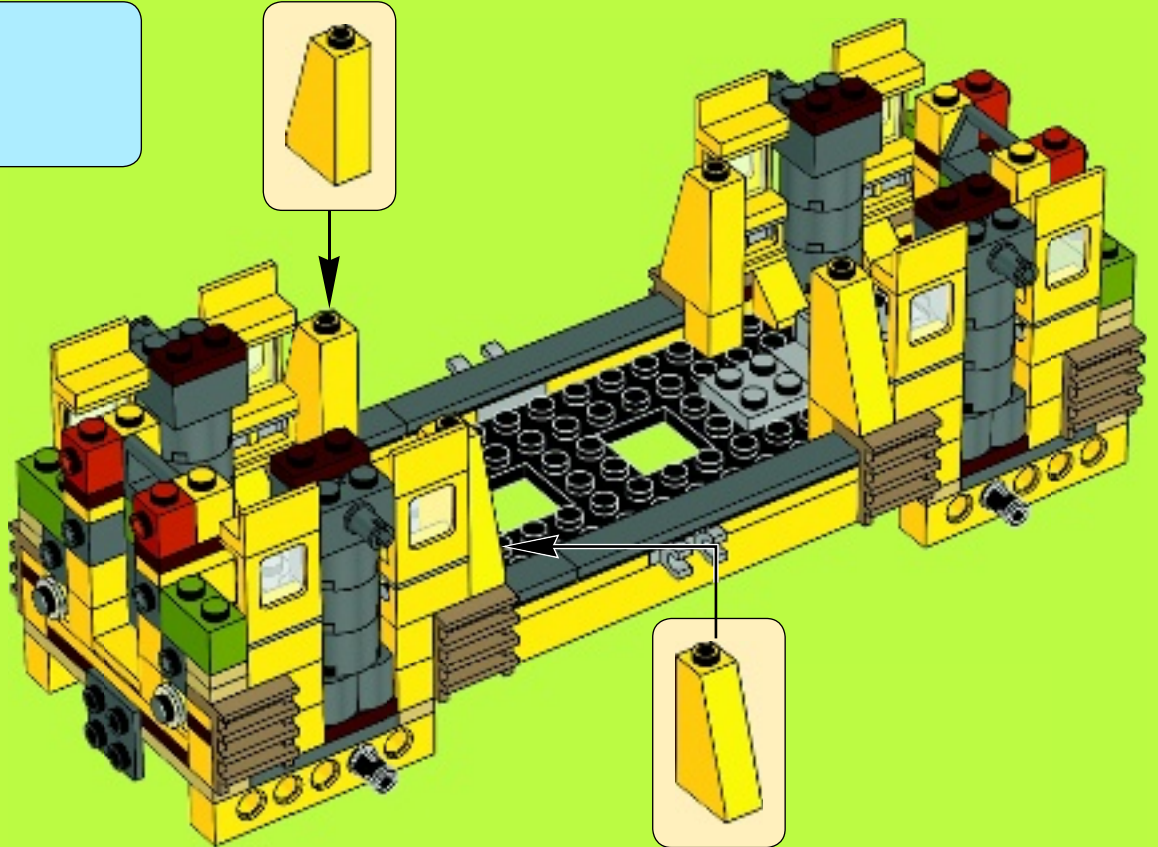



4x



4x

# 30

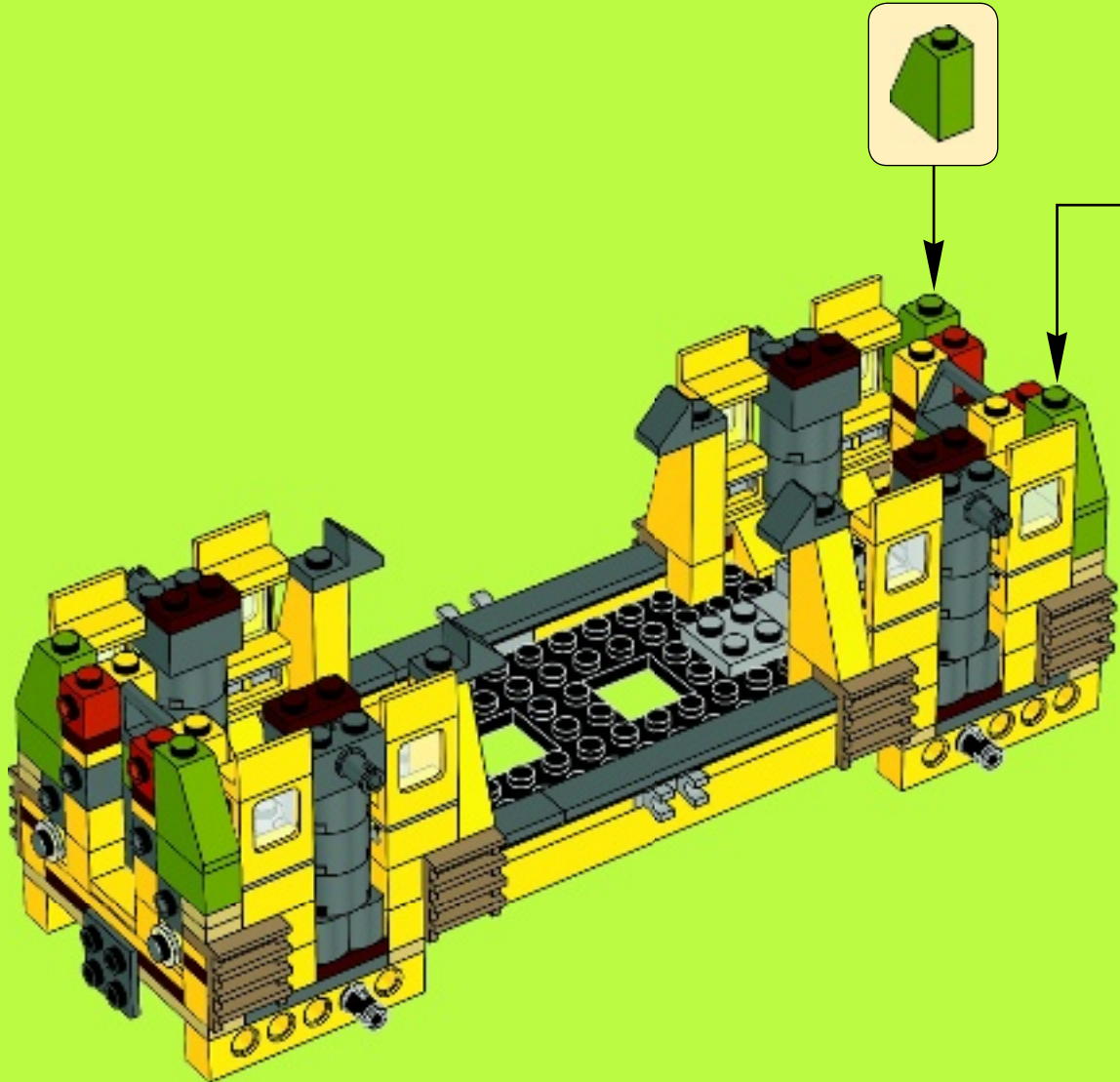



# 31

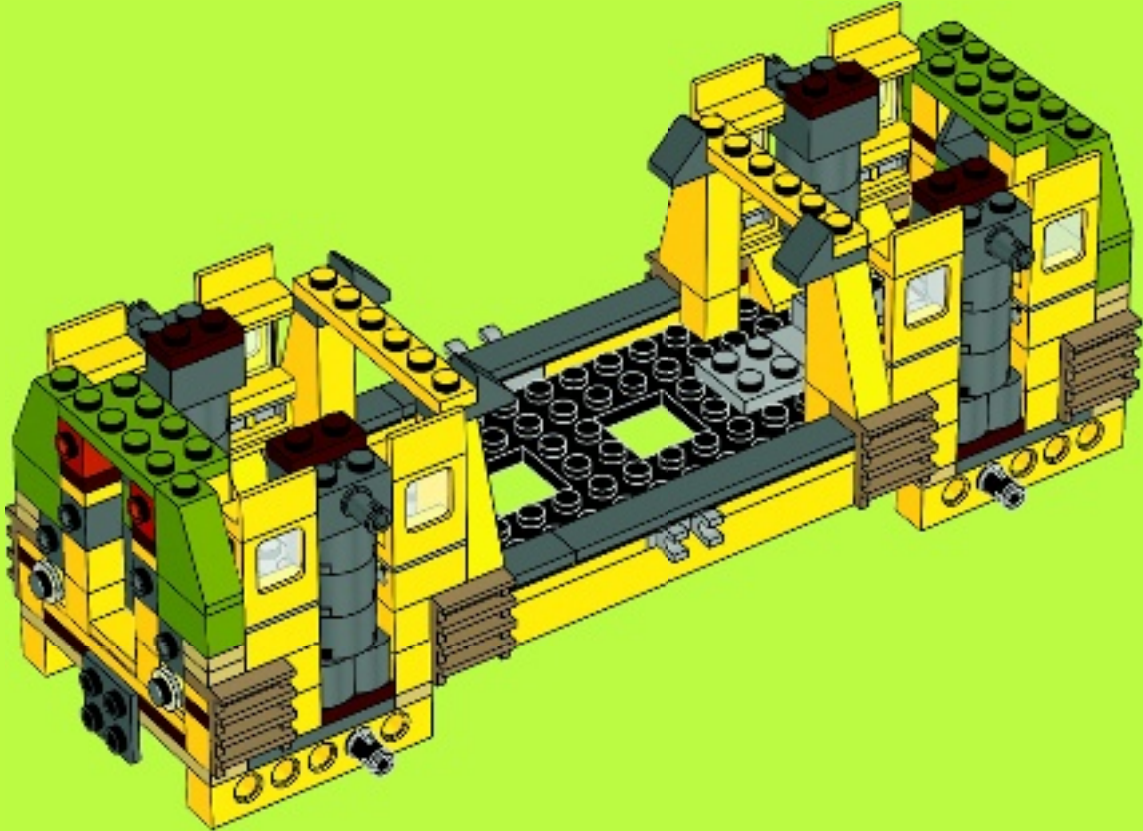

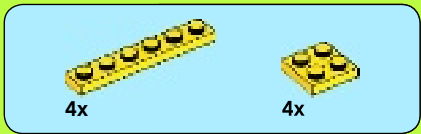

# 32

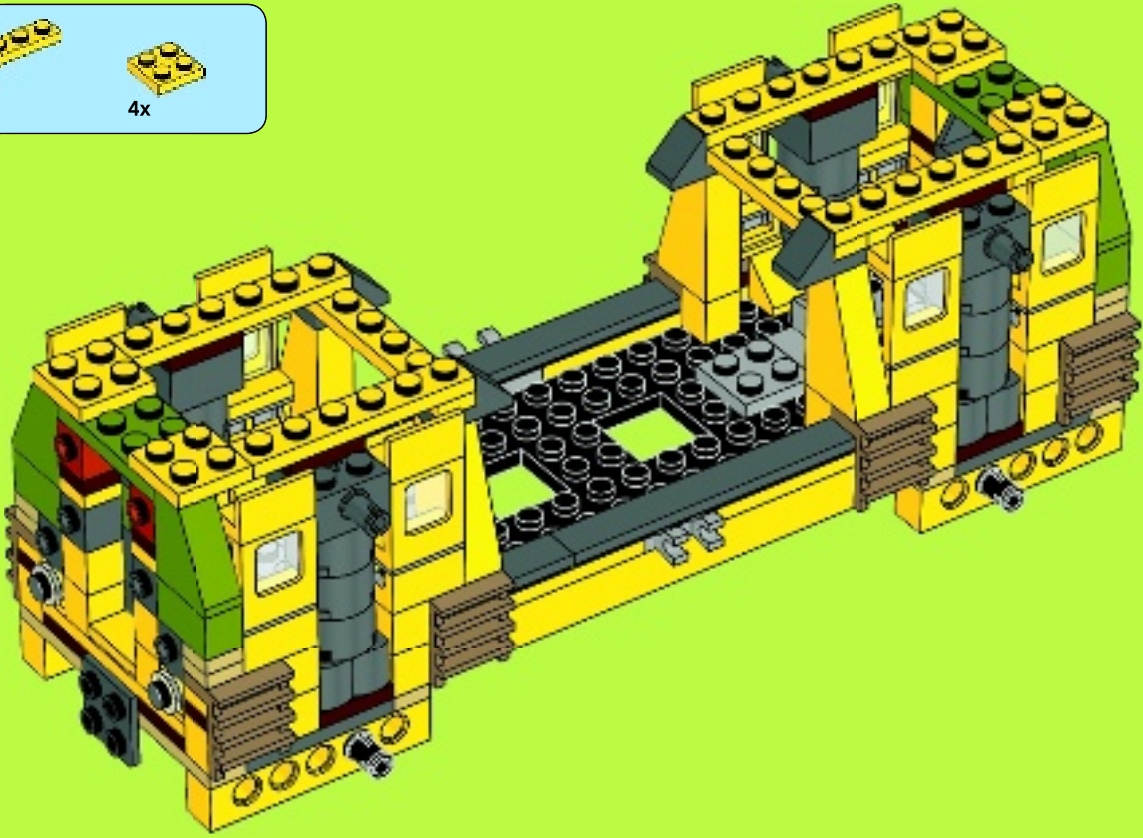

# 33

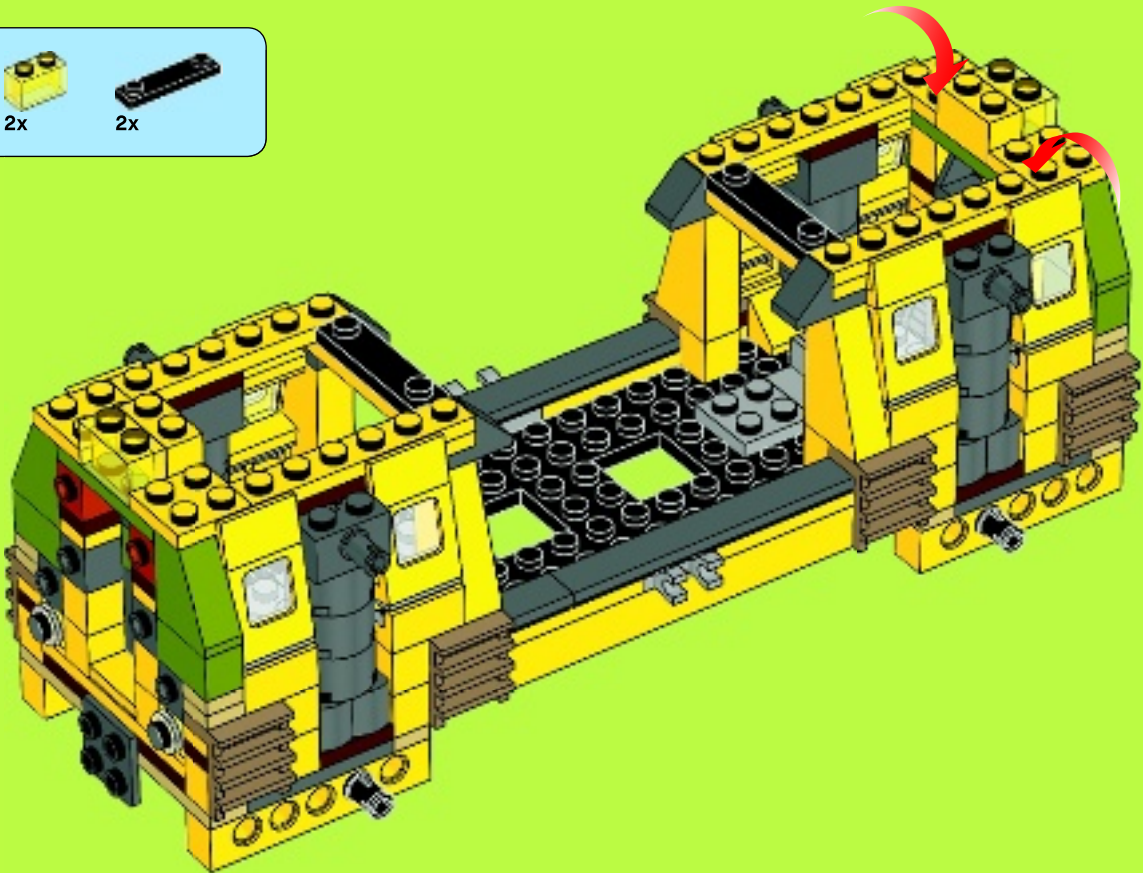

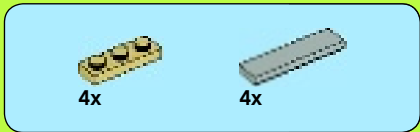

# 34

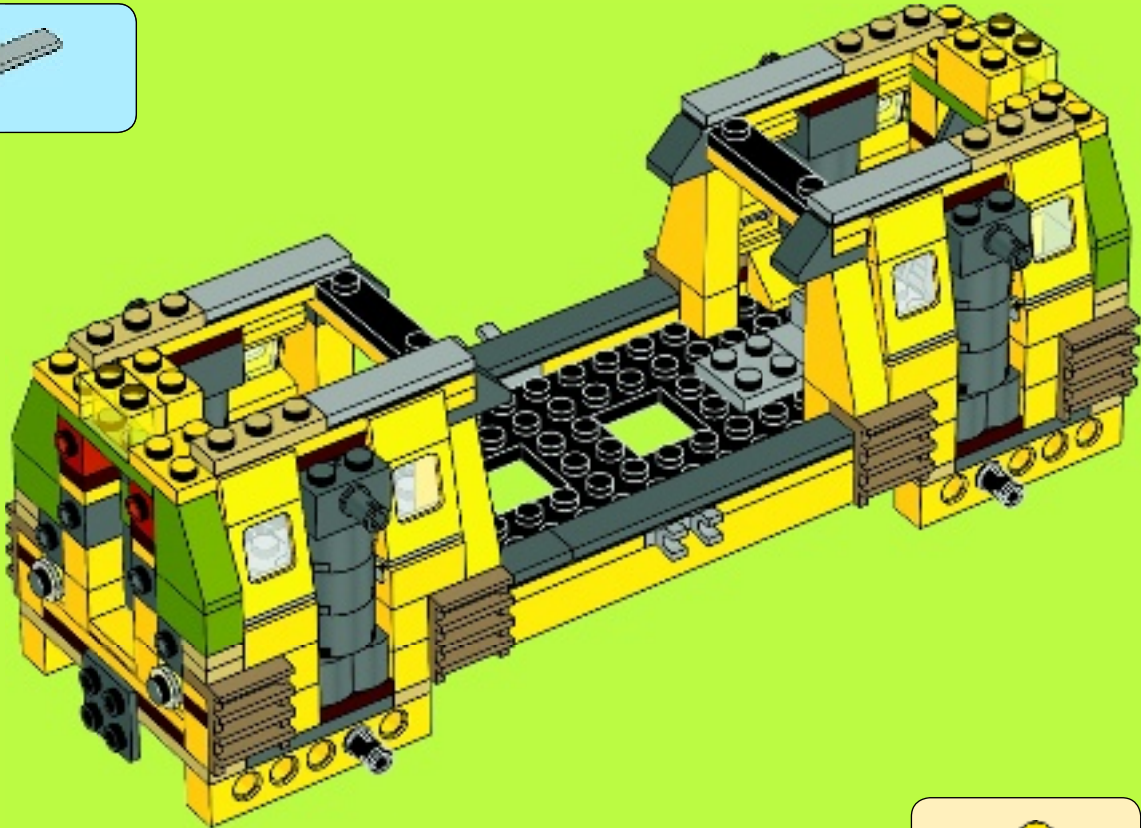

# 35

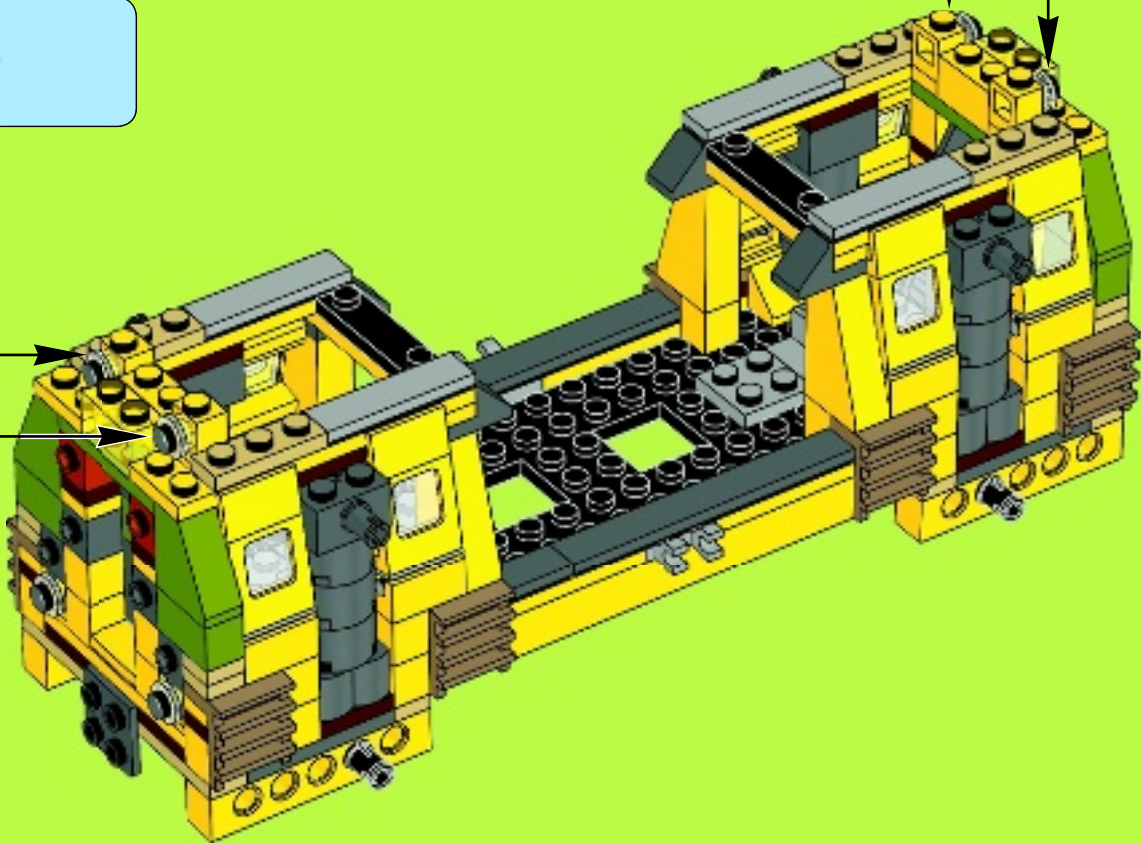
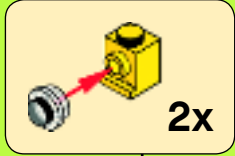





2x



4x

# 36

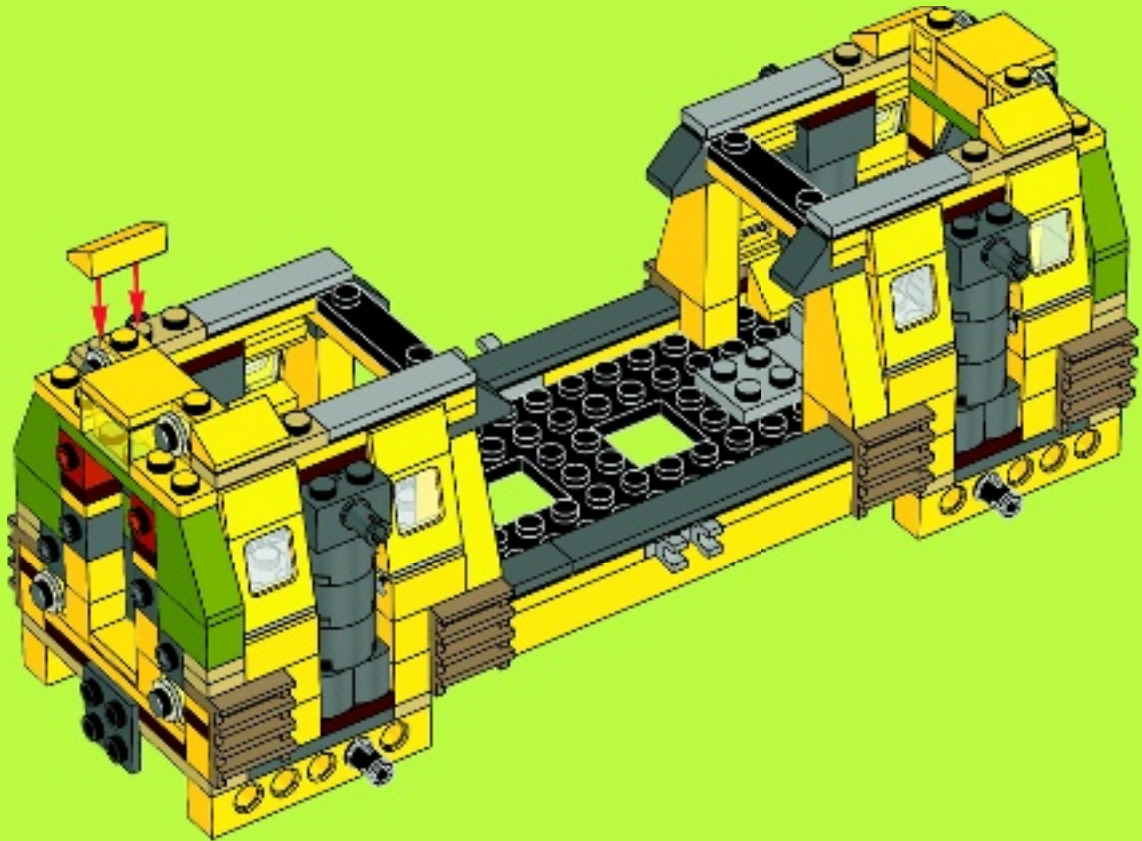

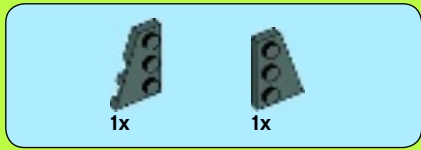

# 37

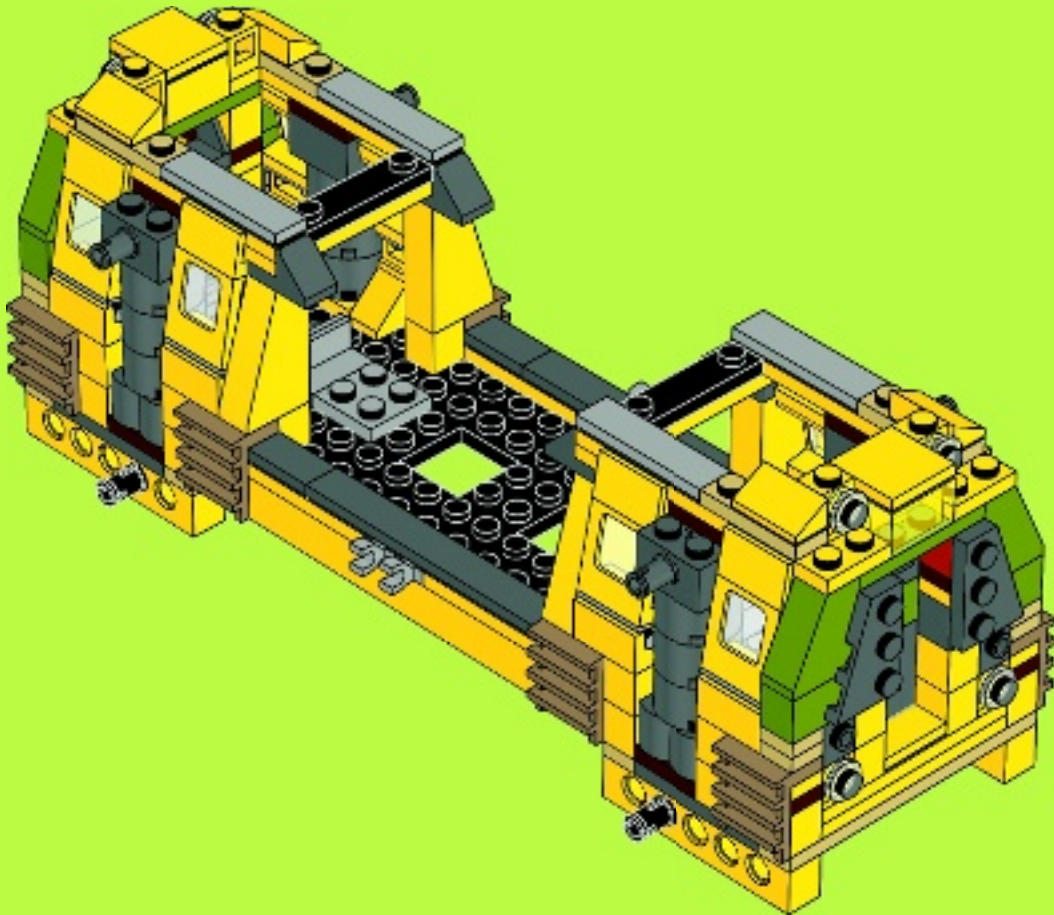



2x



2x

# 38

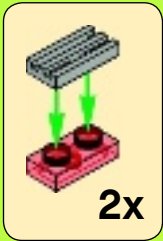
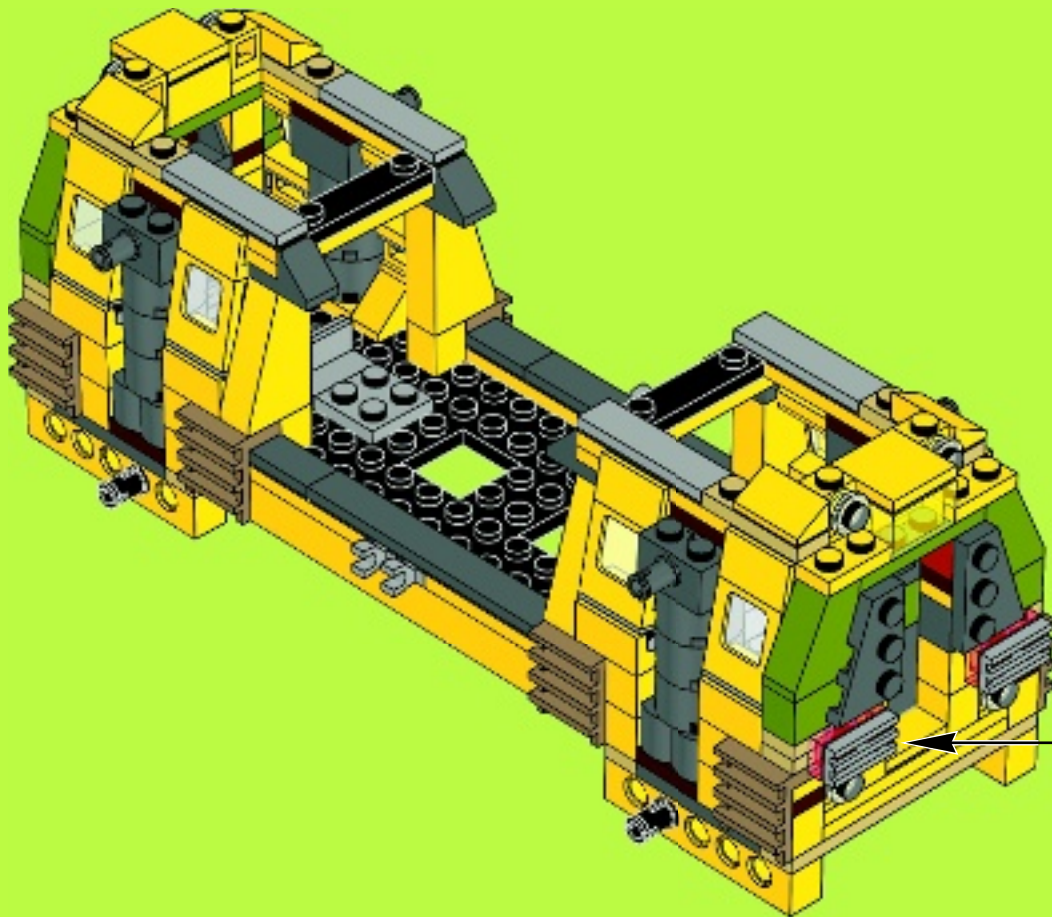

2x

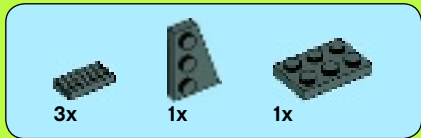

# 39

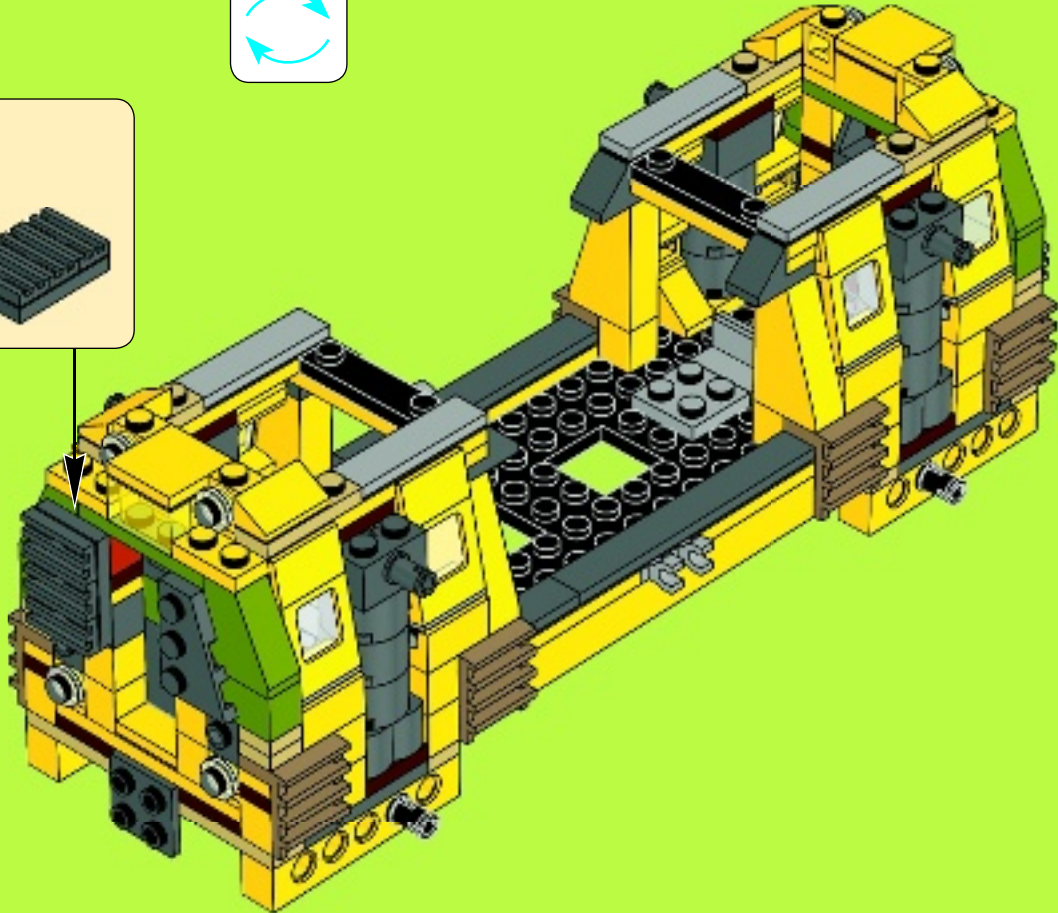
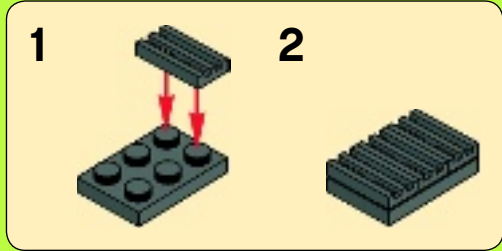



2x



2x

# 40

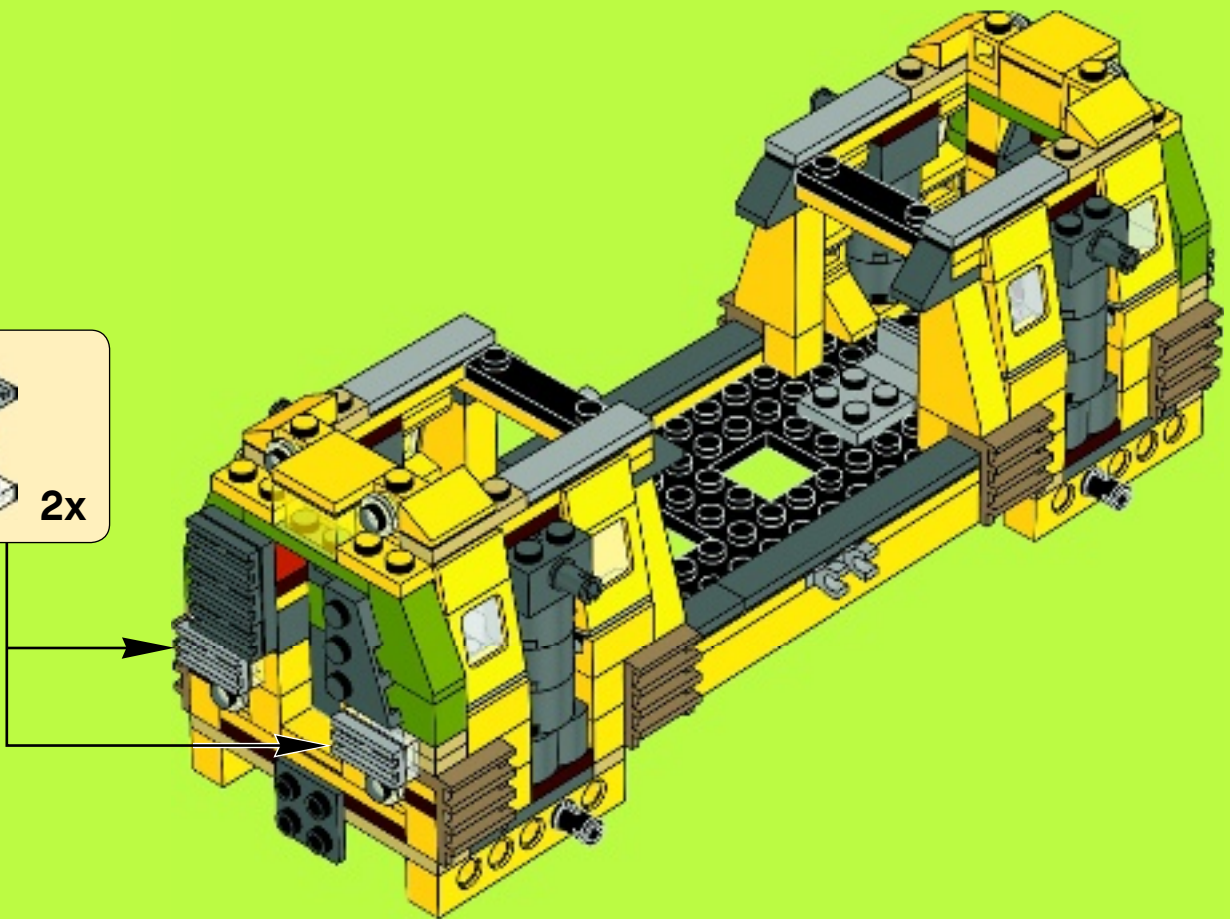
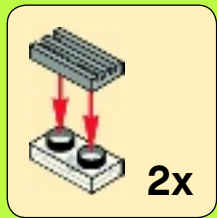

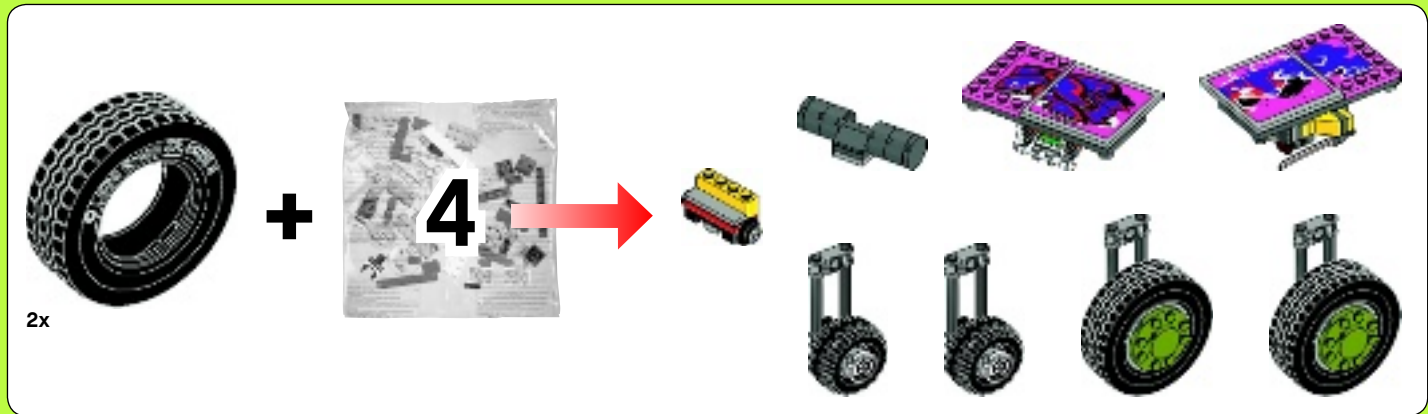

1



3

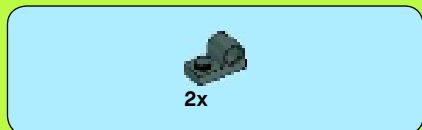
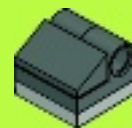

2

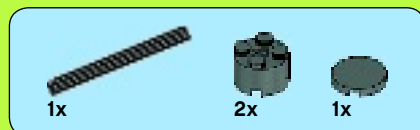
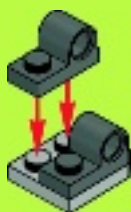

4

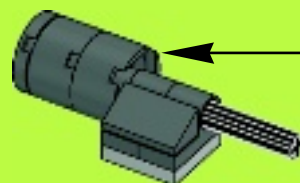
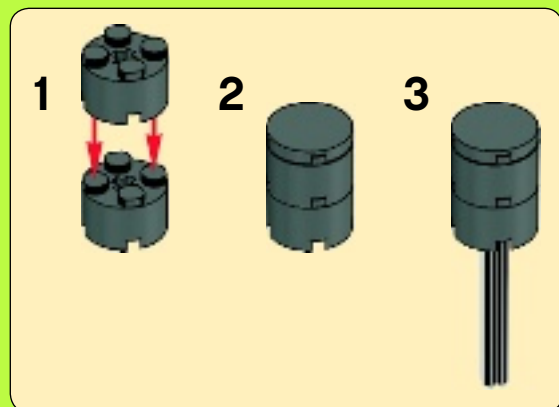



2x



1x

5

1



2

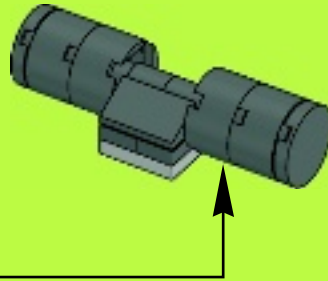

41

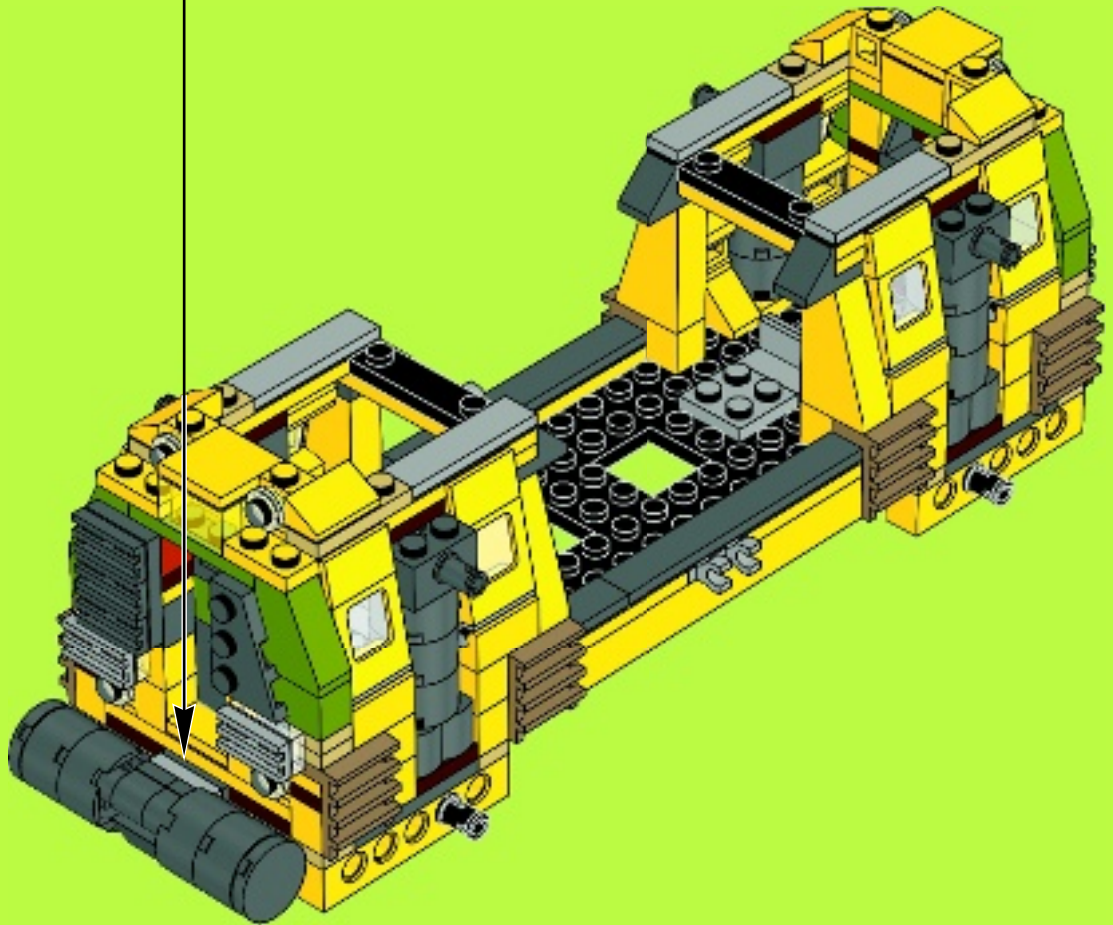



1x

# 42

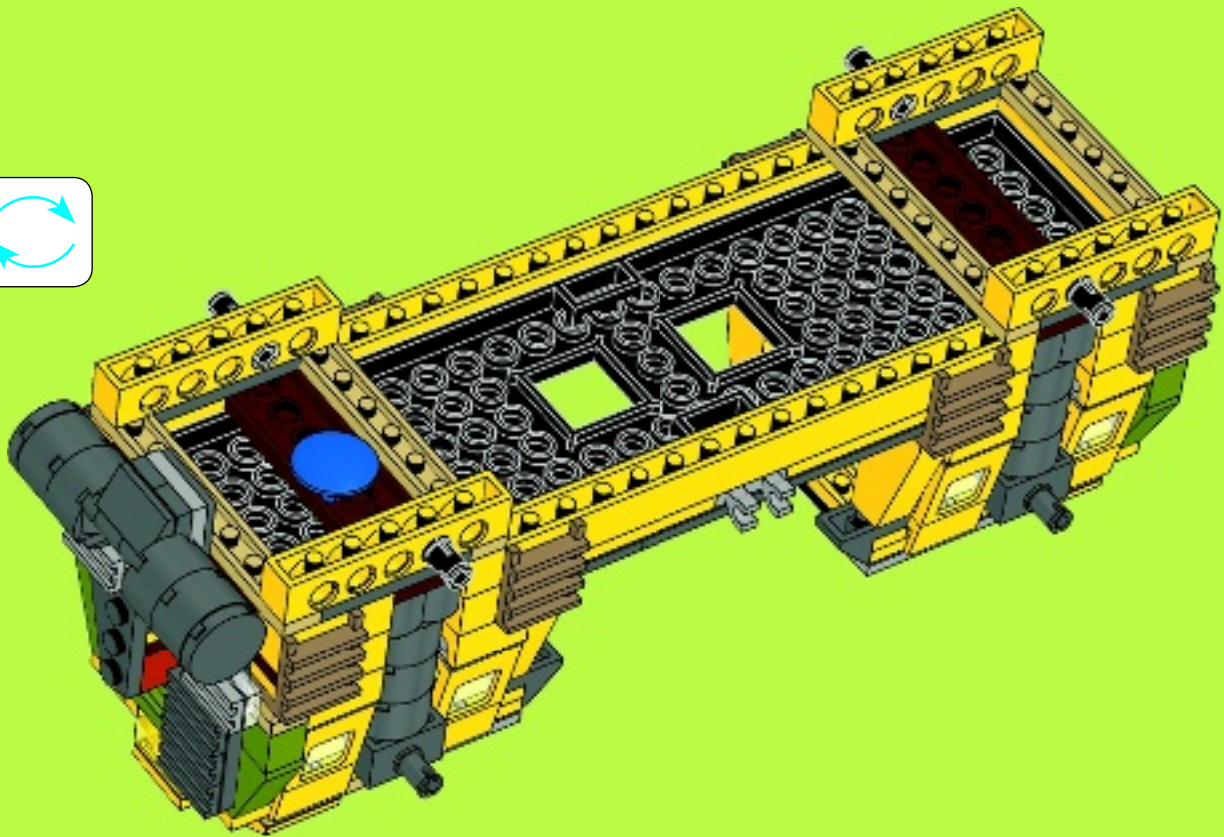



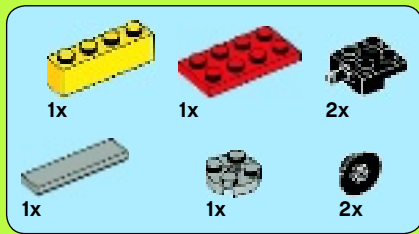

# 43

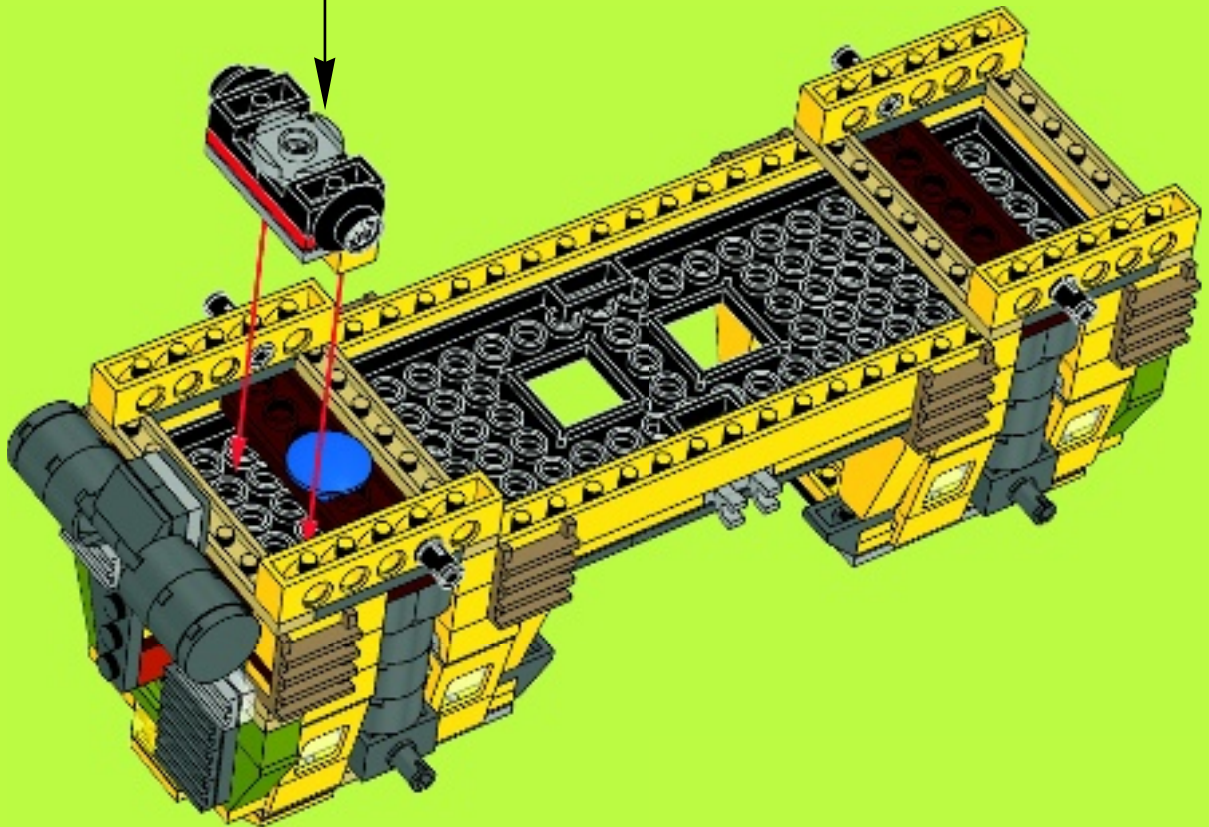
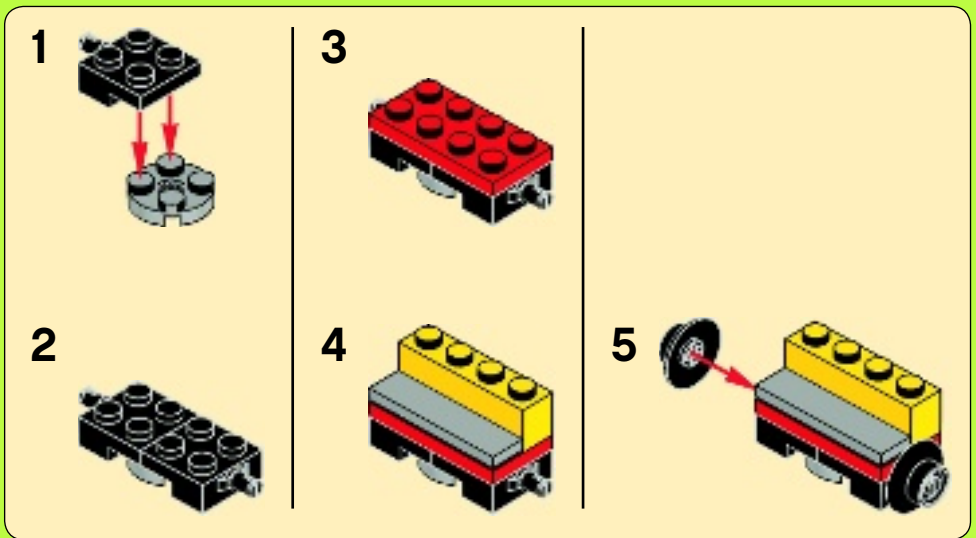

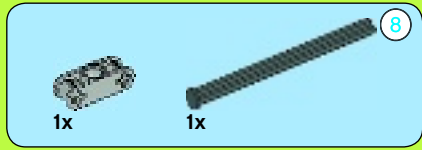

1

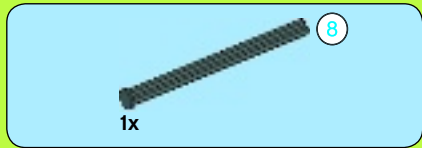

2

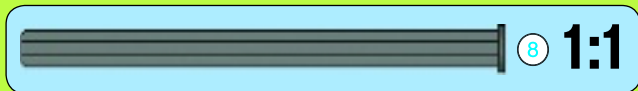

3



4



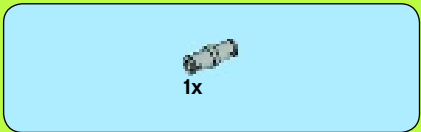

5

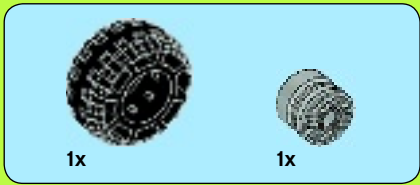
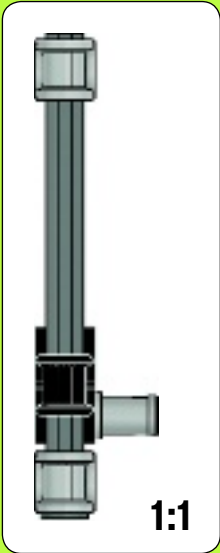

6

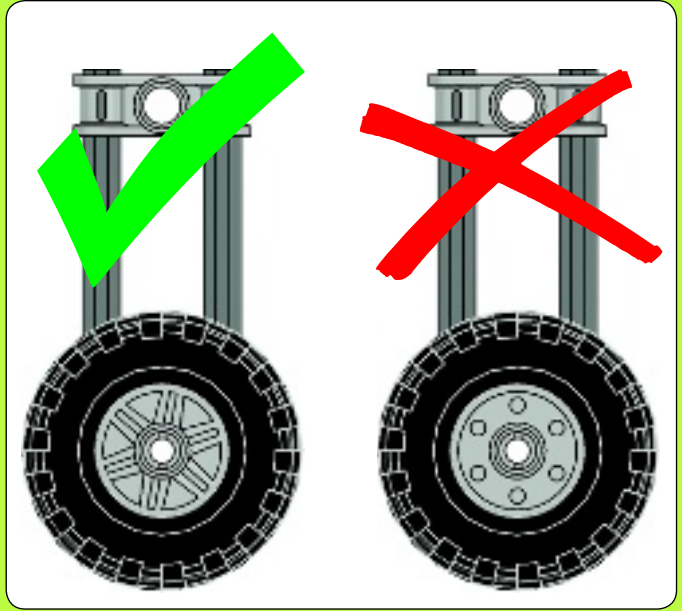
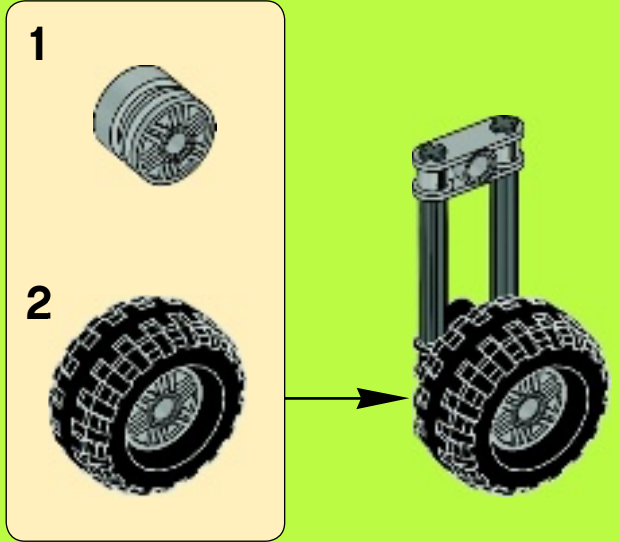



7



8

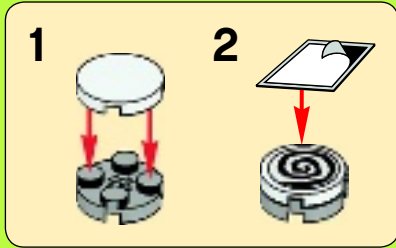

2x

44

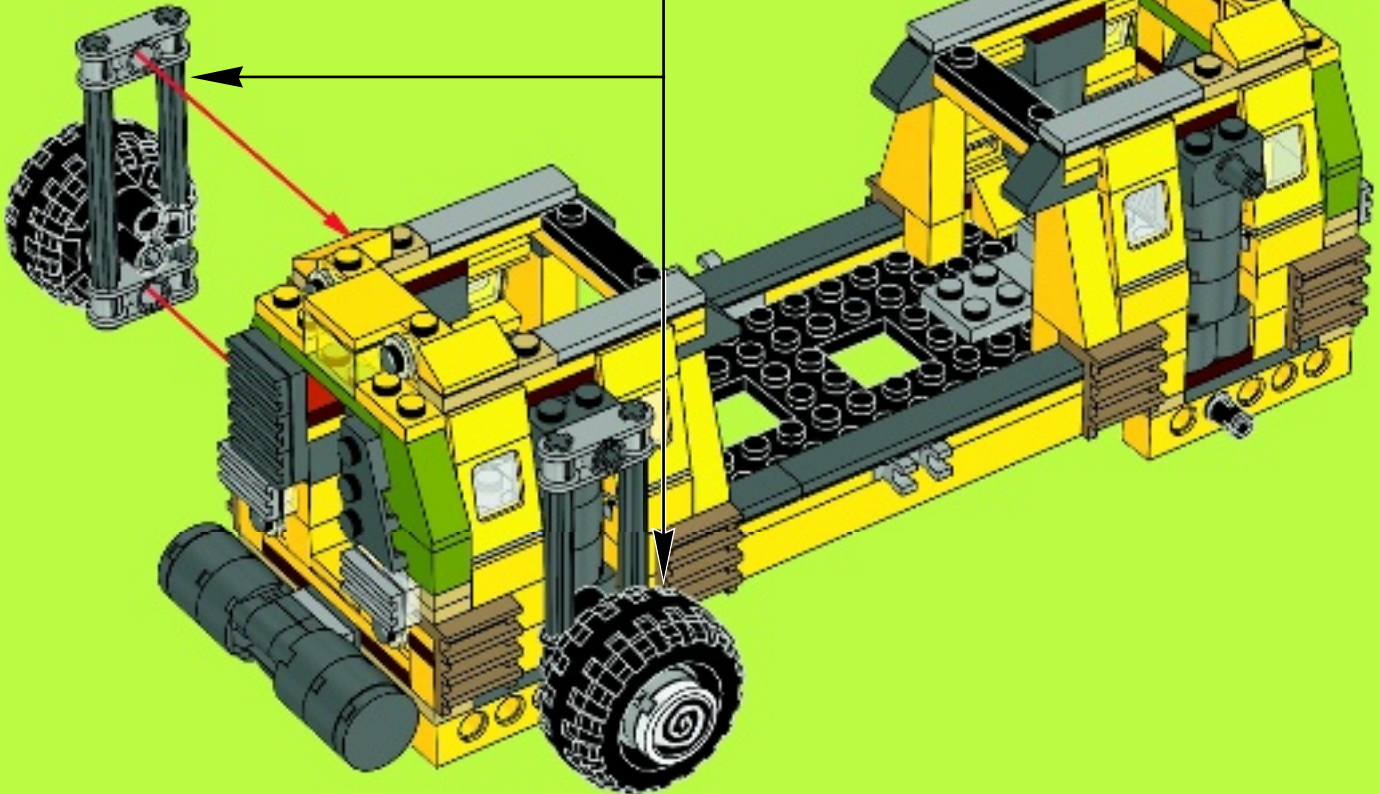

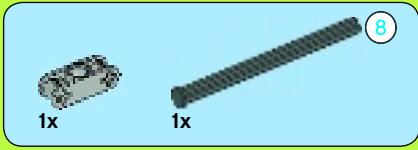

1

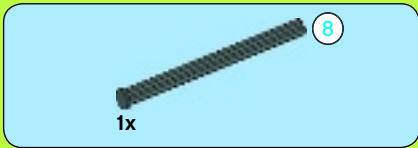
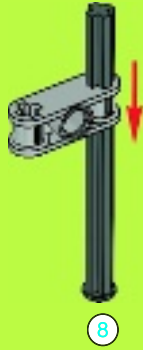

2

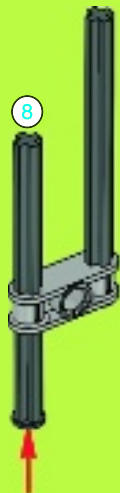

3



4



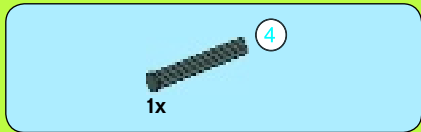

5

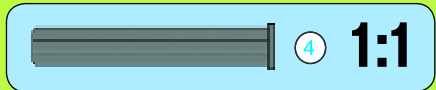
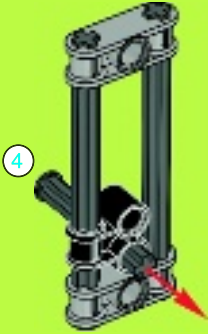

6

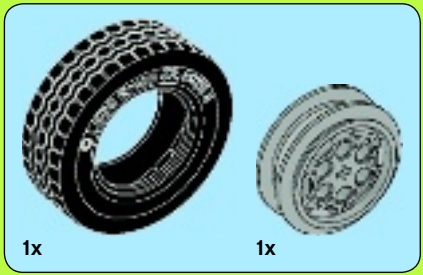
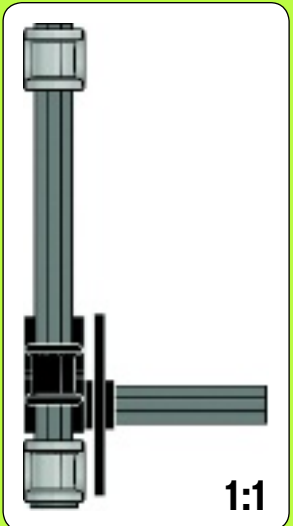

7

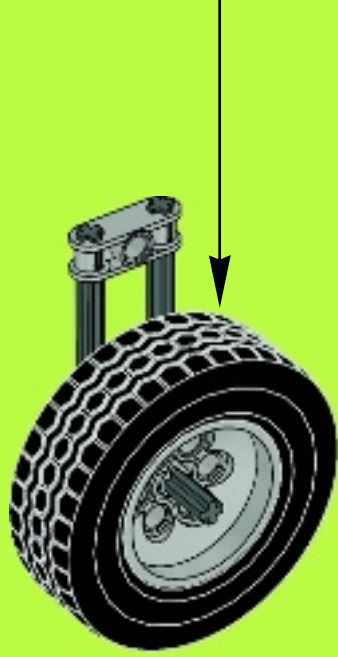
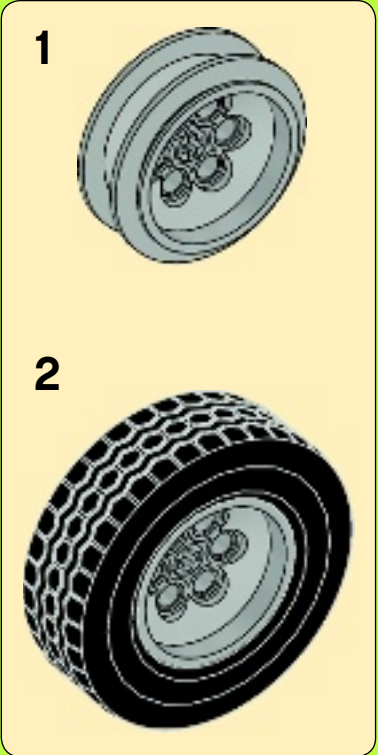



8



9



2x

45

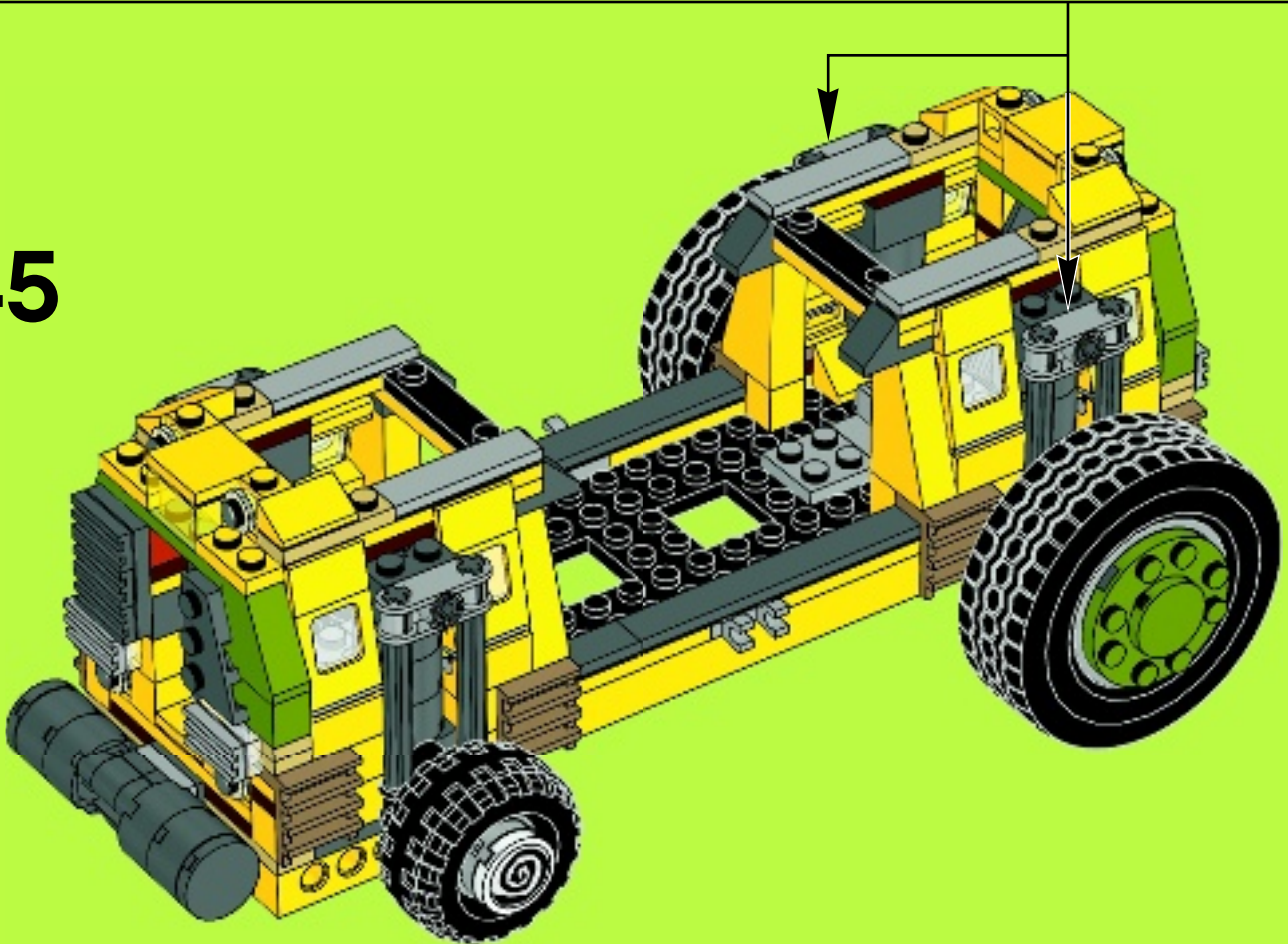



1

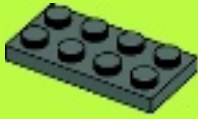

2

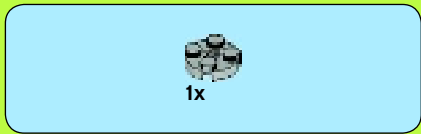

3

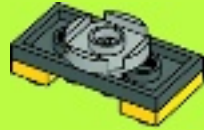

4





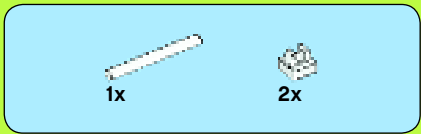

5

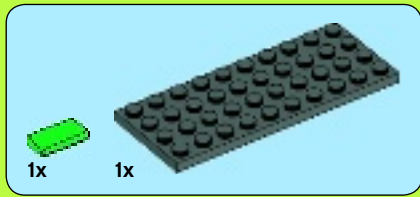
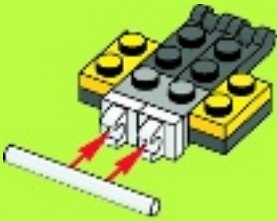

7

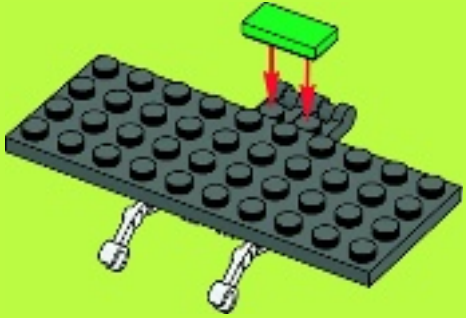

6

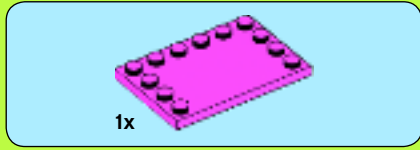

8

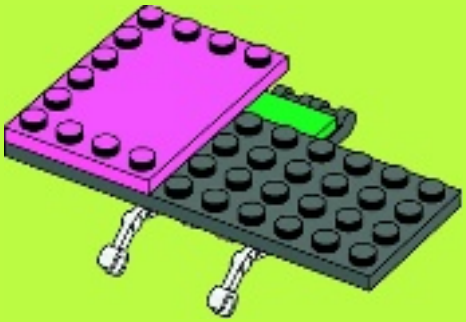

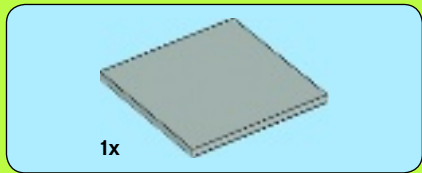

9

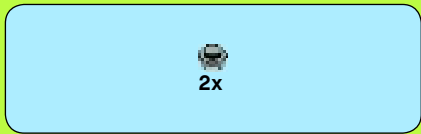
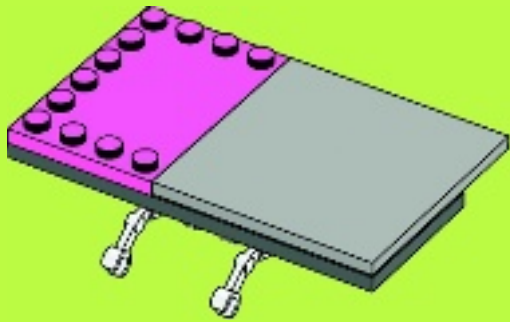

11

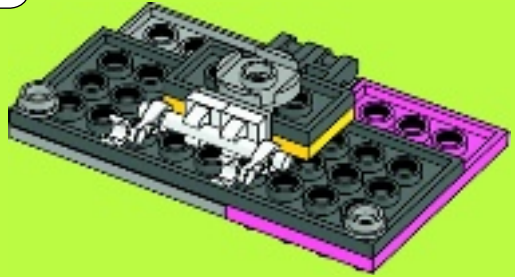

10

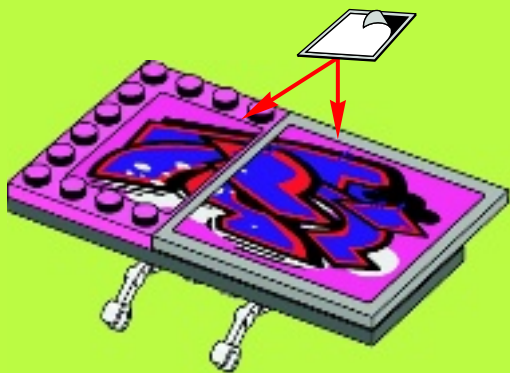



# 12

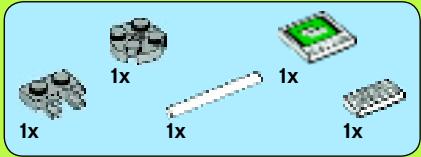
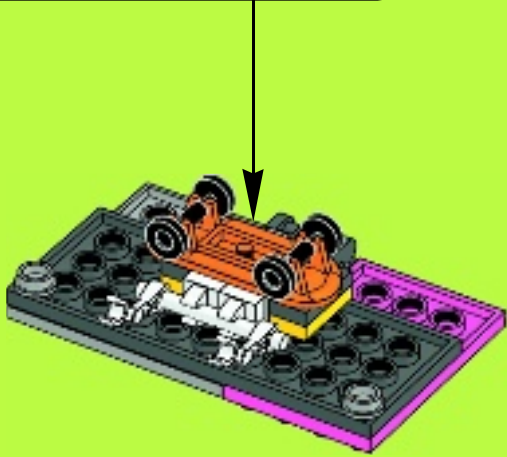

# 13

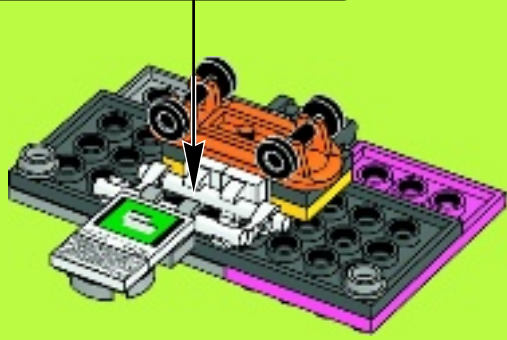
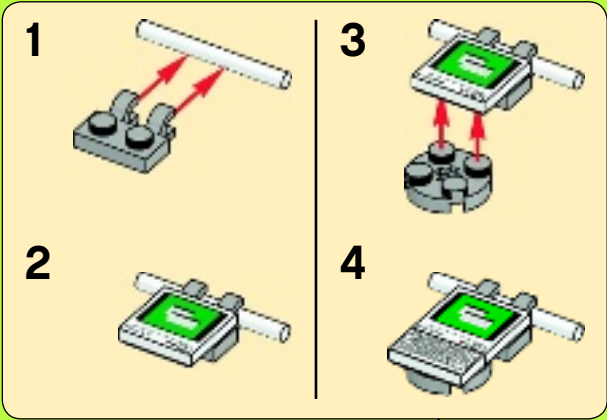

14

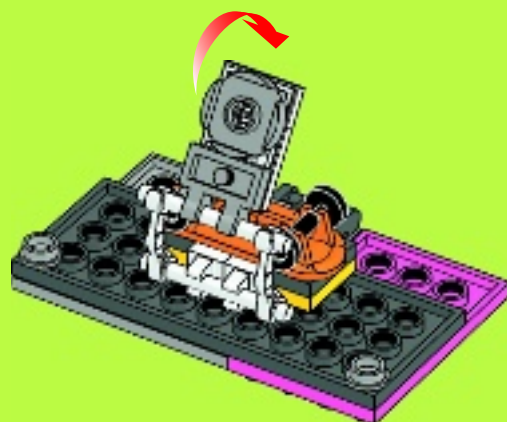

46

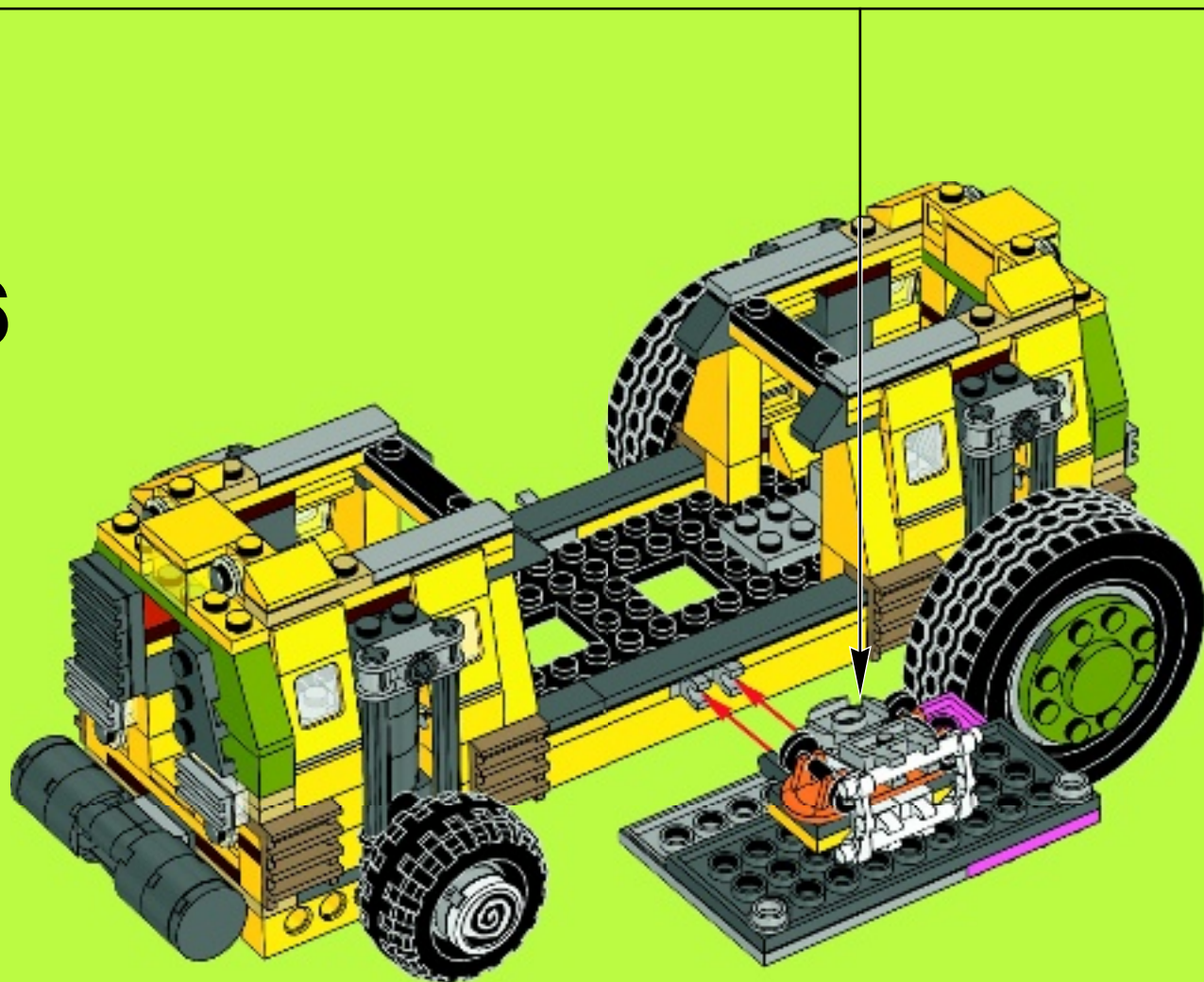



1

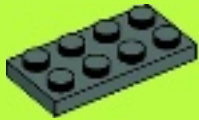

2

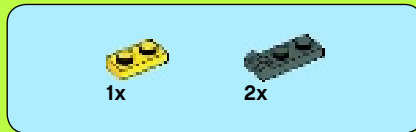

3

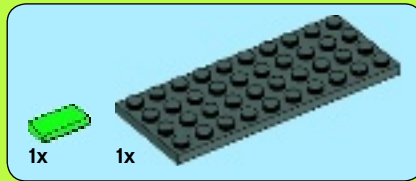

4

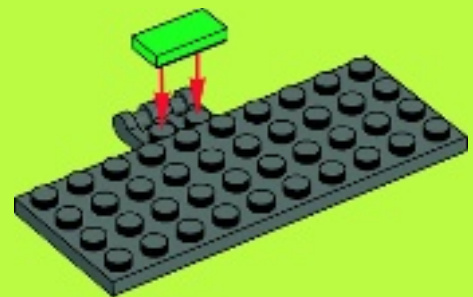

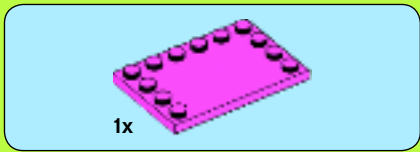

5

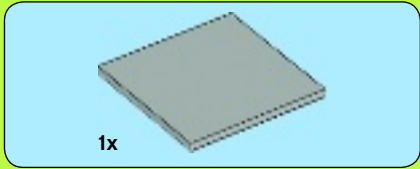
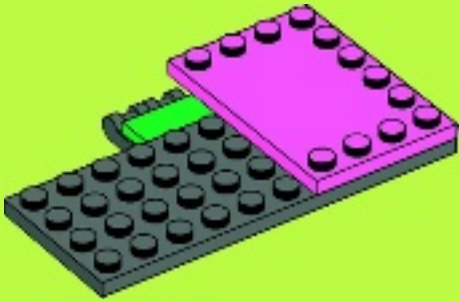

6

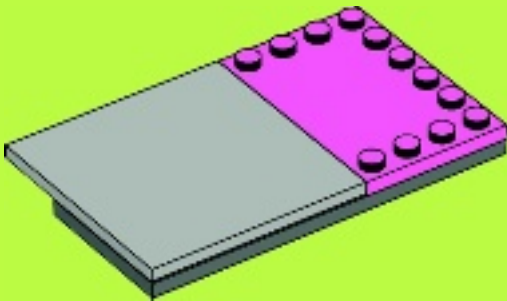

7

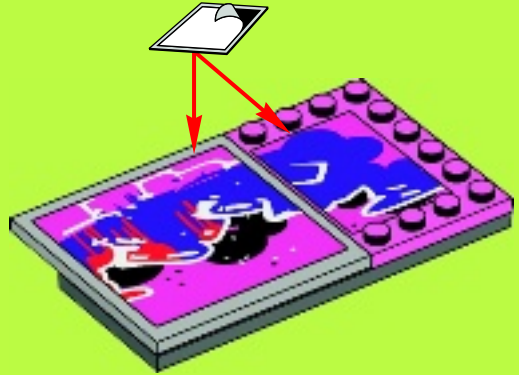

8

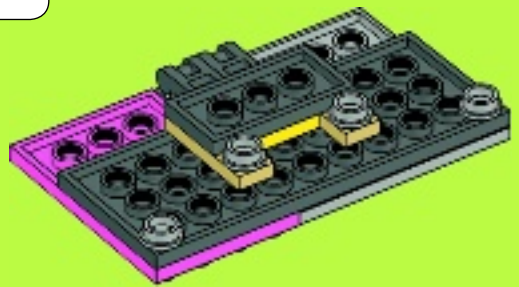
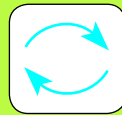

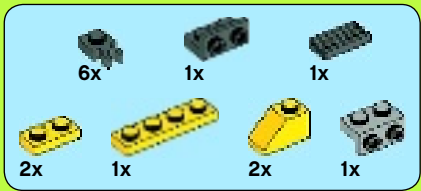

9

1



3

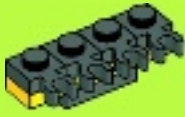

5

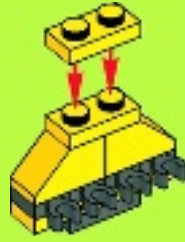

7

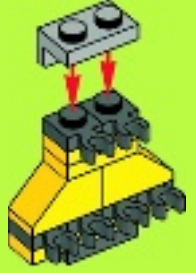

2



4

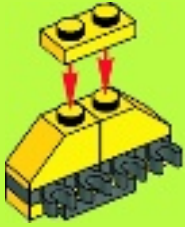

6



8

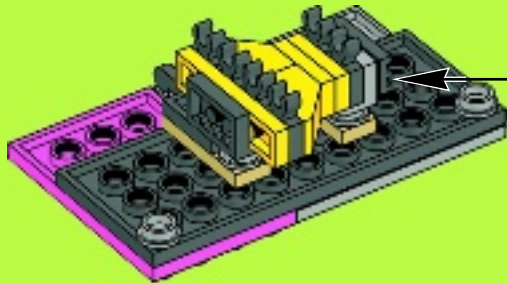
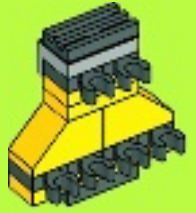

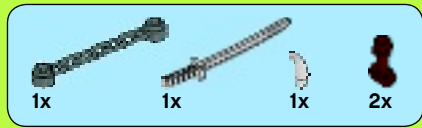

10

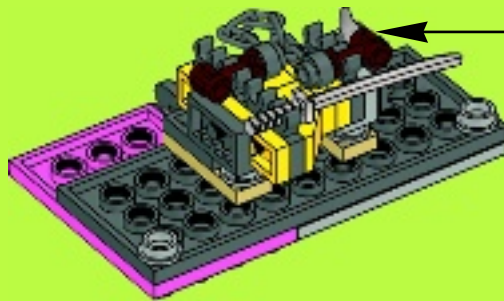

47

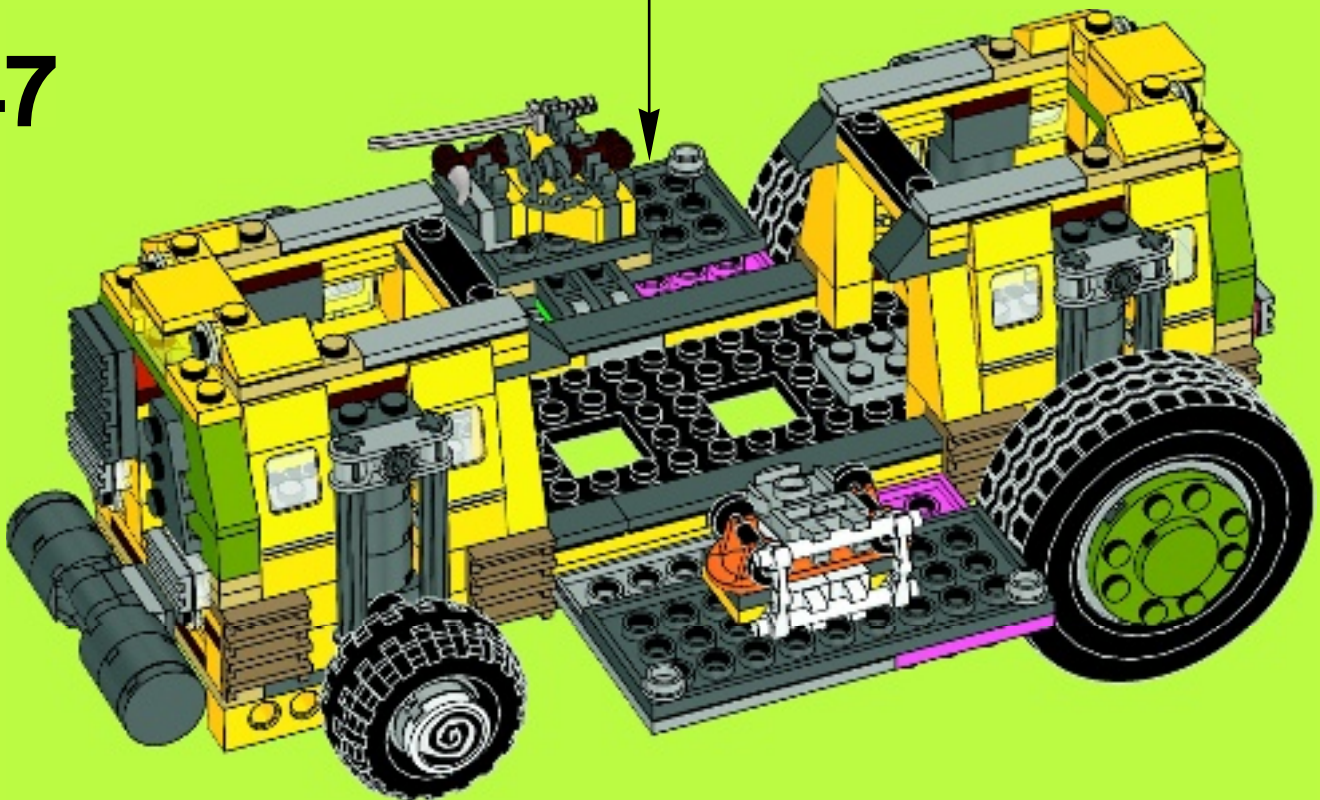





5

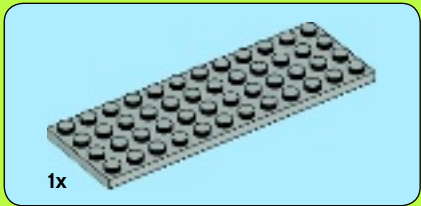

1x

1

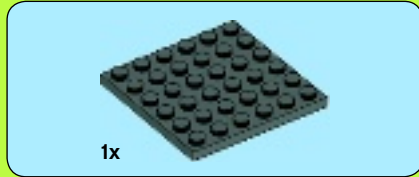

1x

2



2x

3

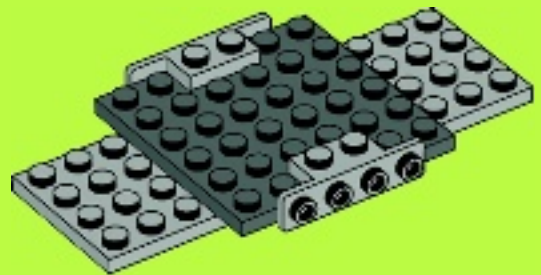
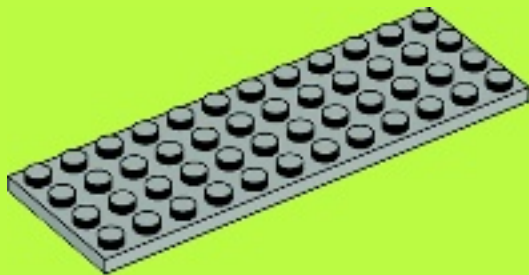



4

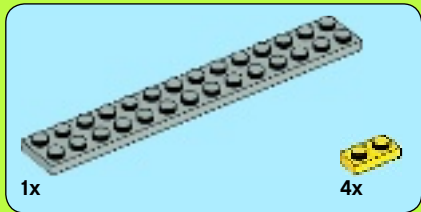
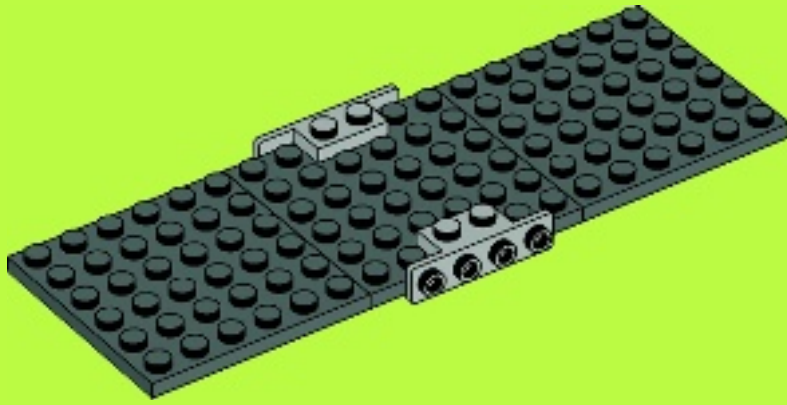

5

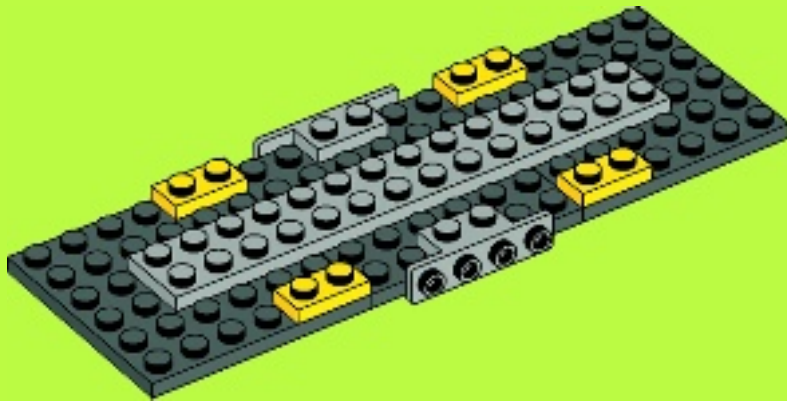



6

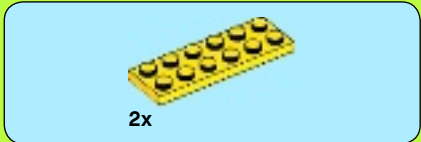
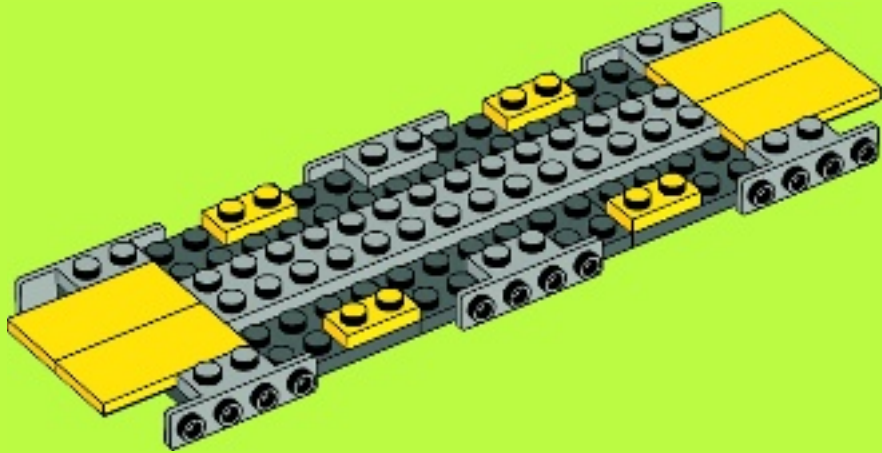

7

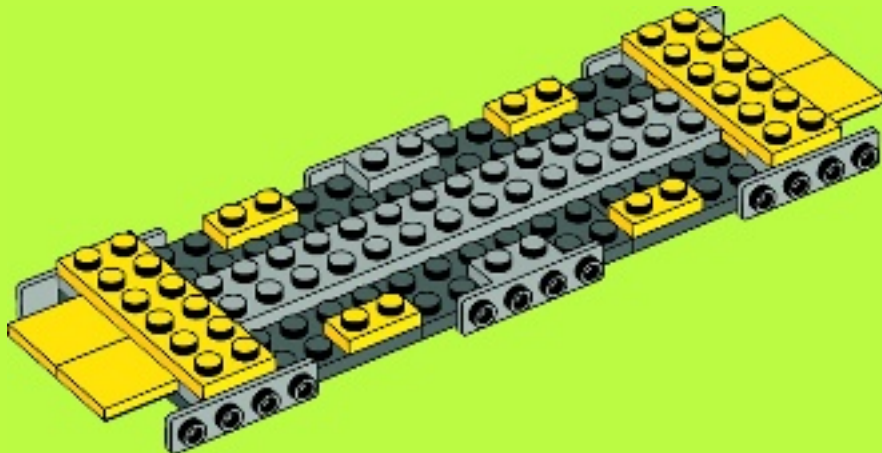

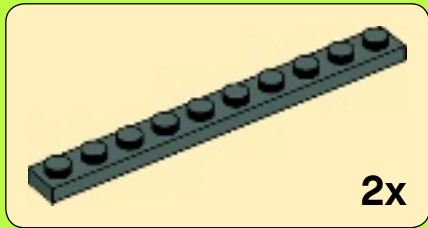
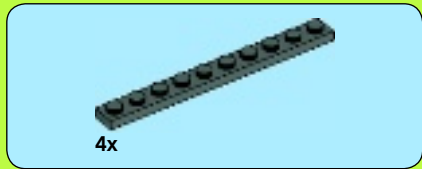

8

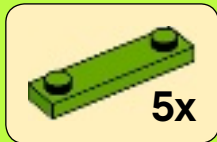
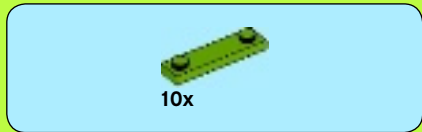
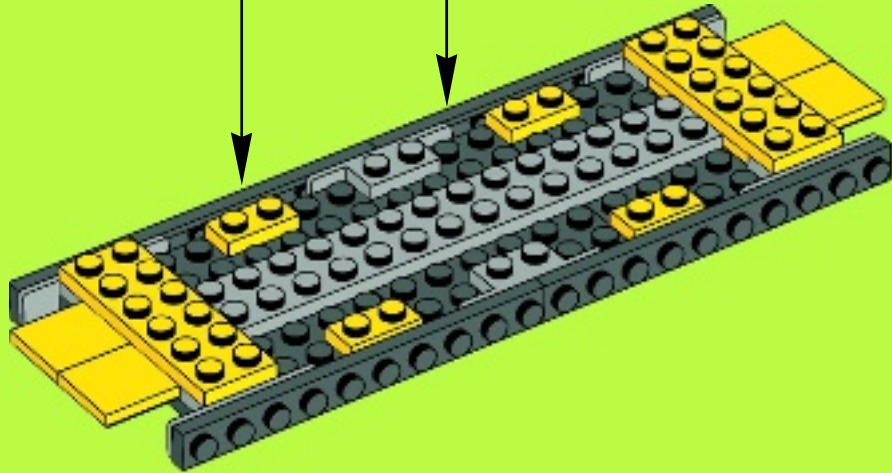

9

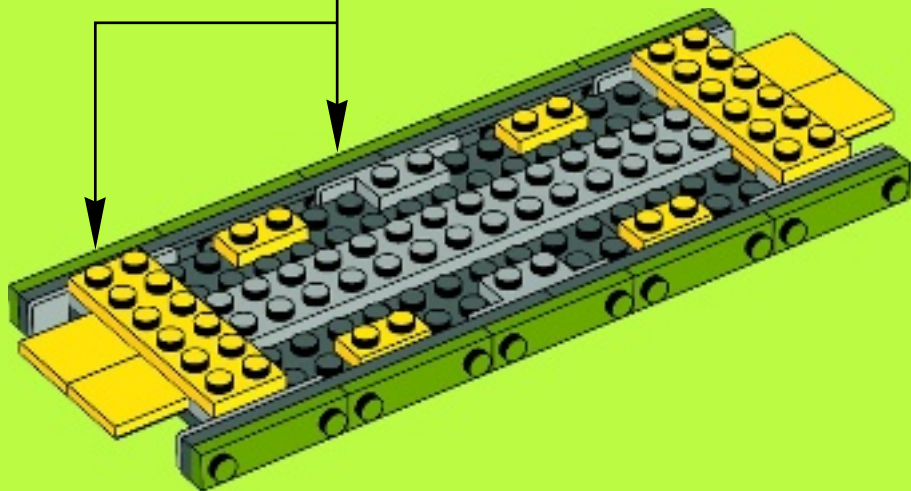

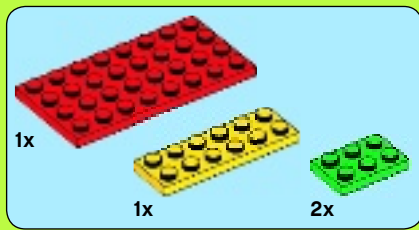

10

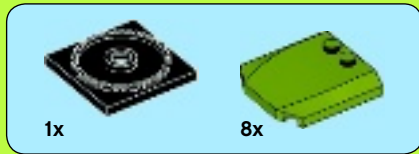
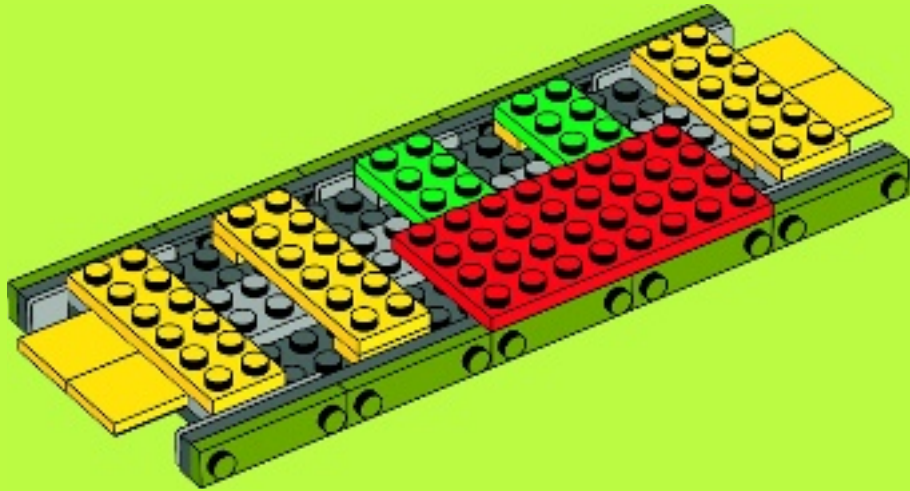

11



48

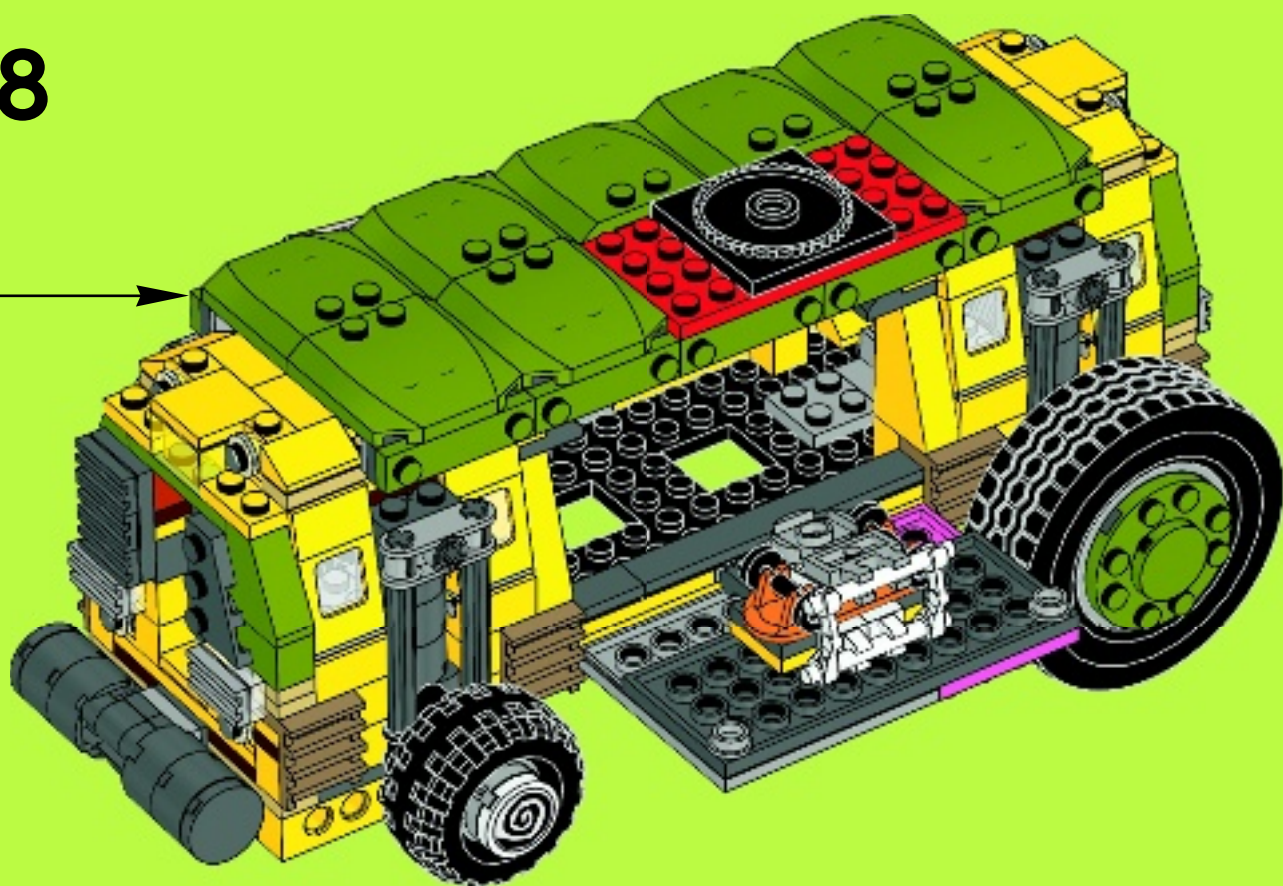

49

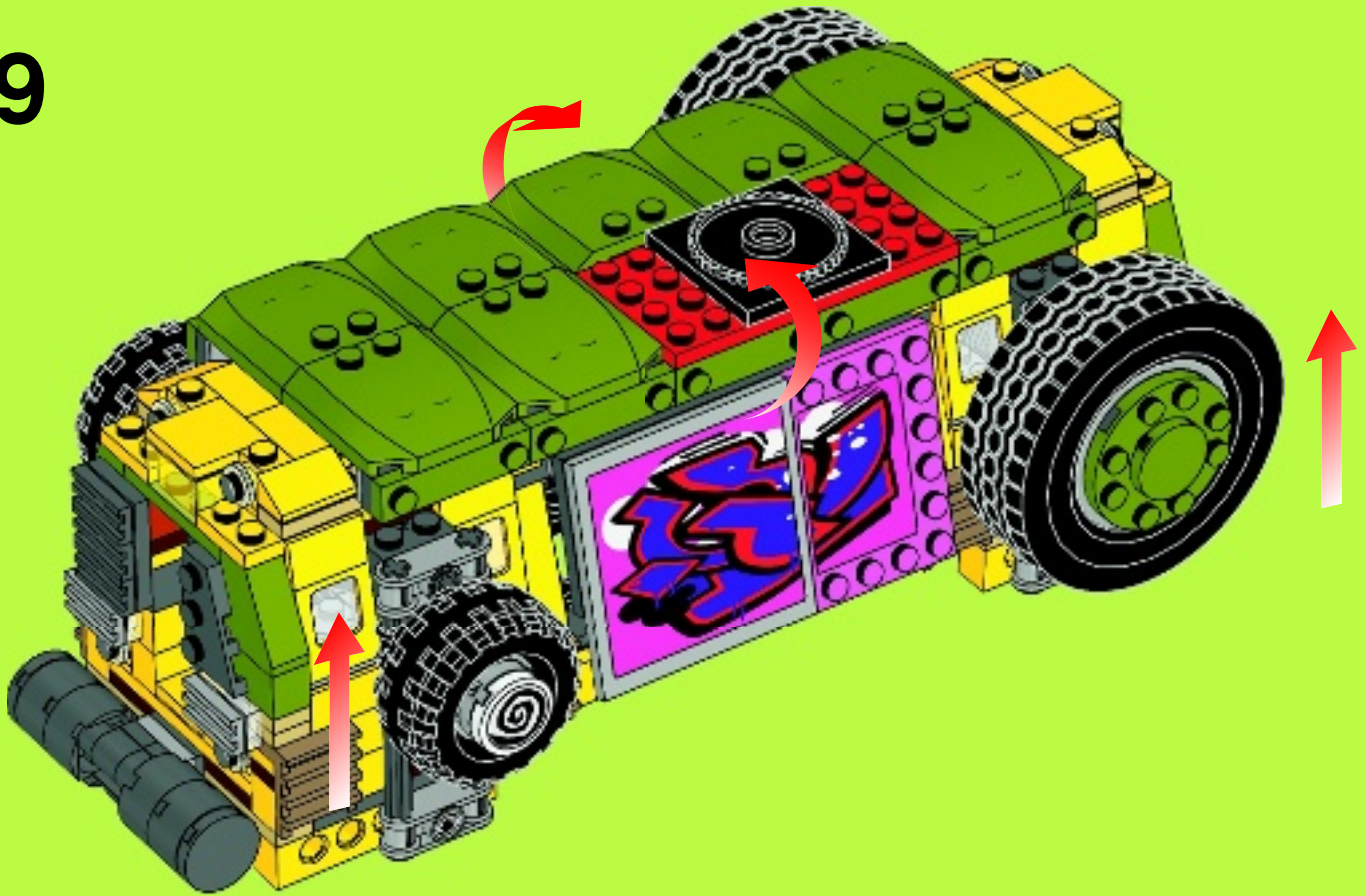

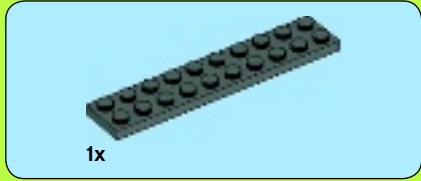
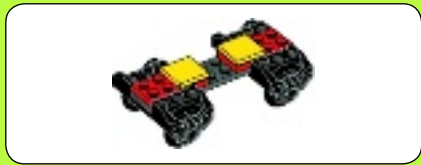

1

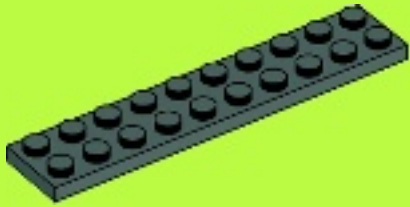

2

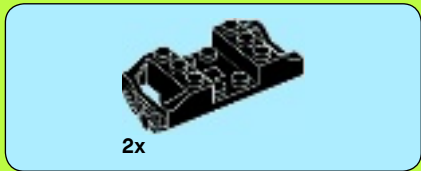
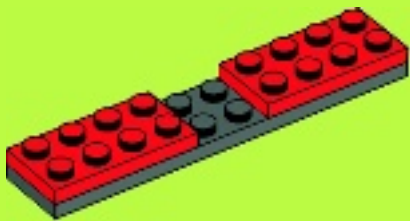

3

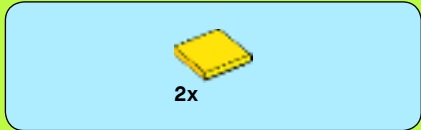
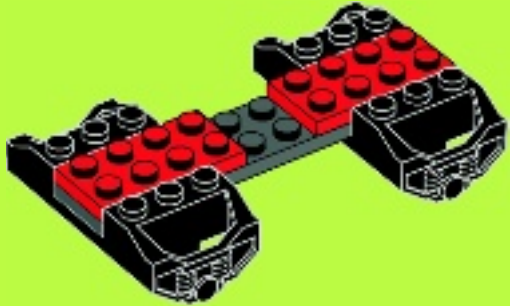

4







5

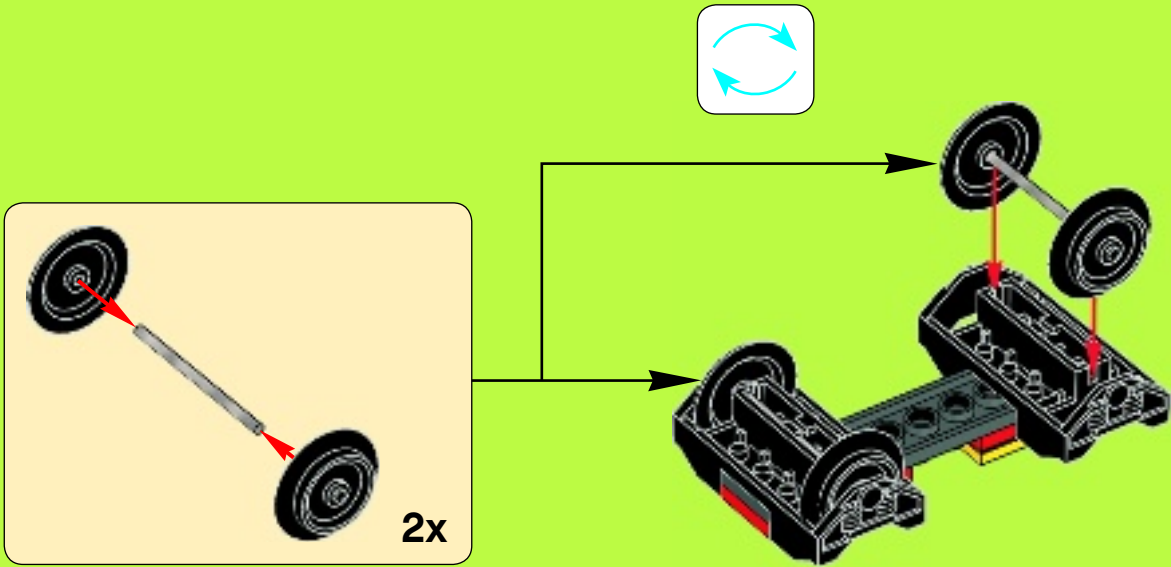

50

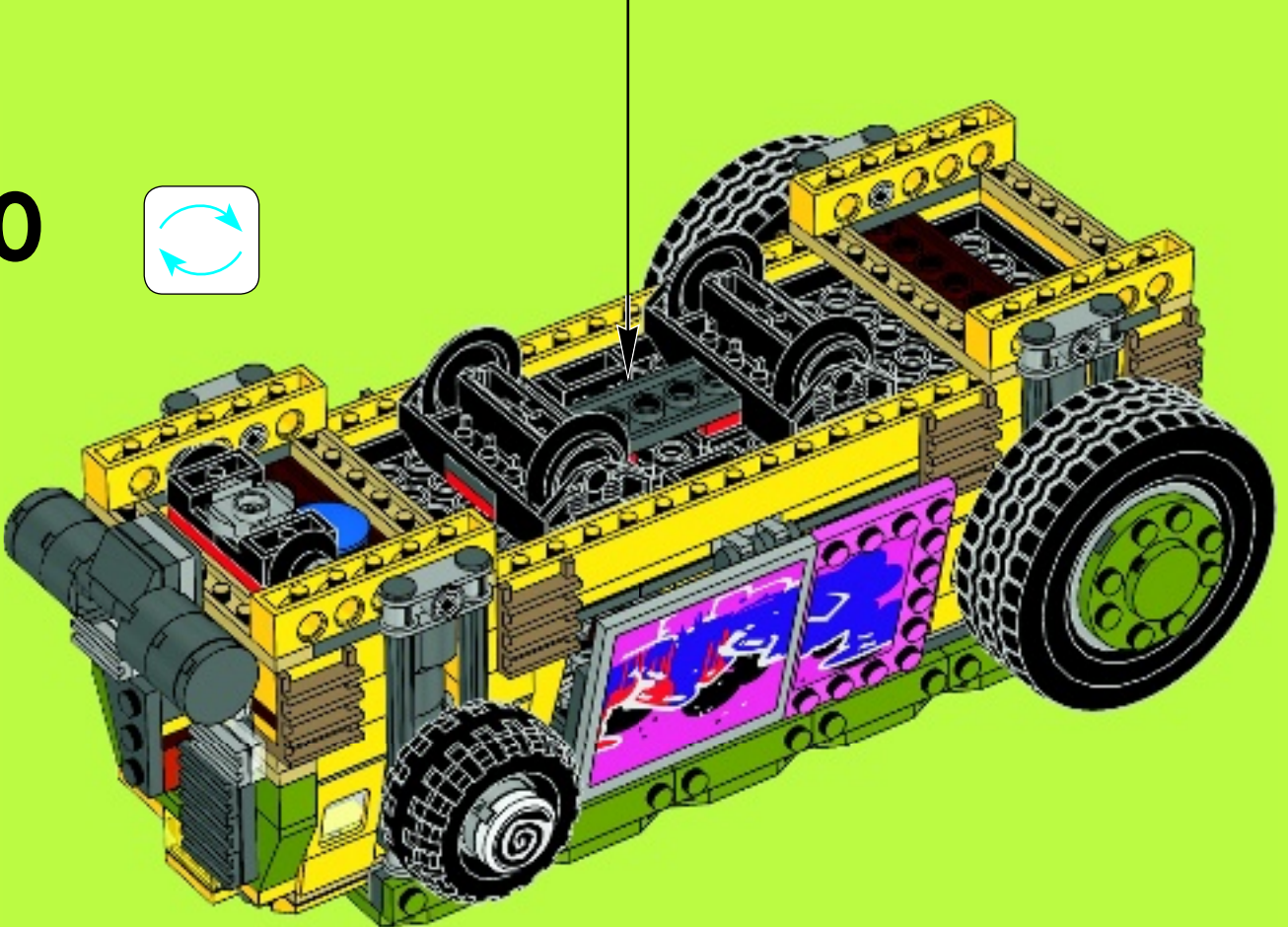



1



2

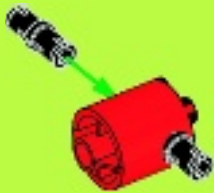

3

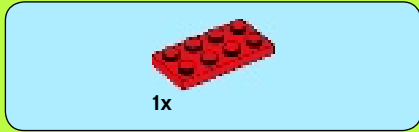
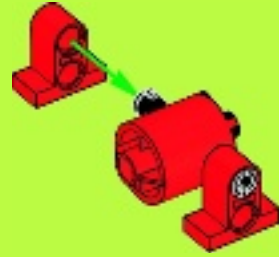

4

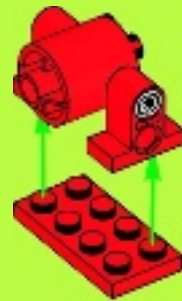



5



7

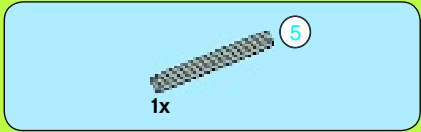
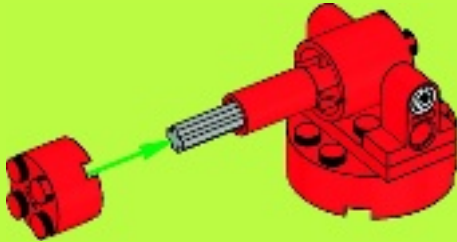

6

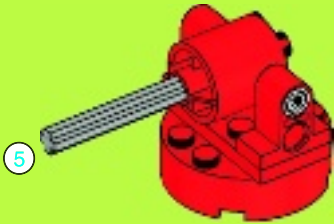

8

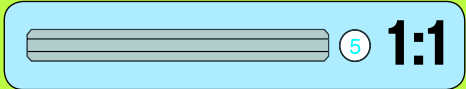
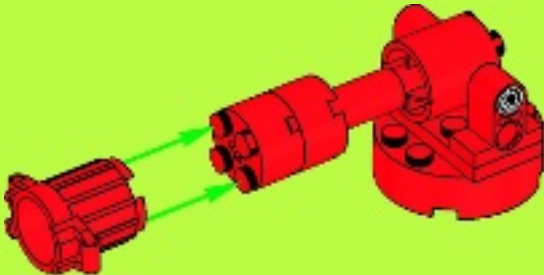

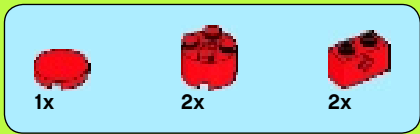

9

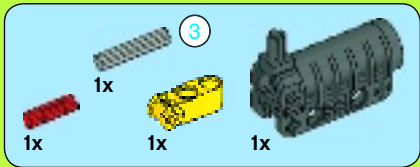
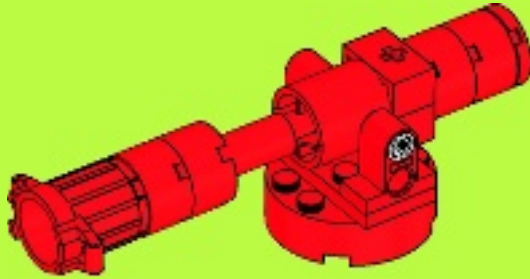
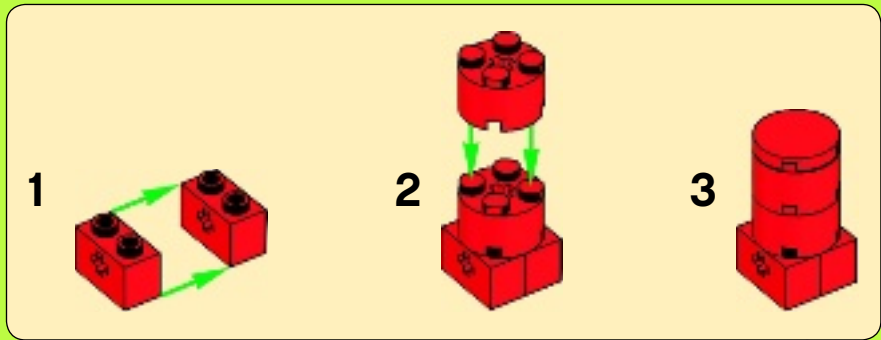

10

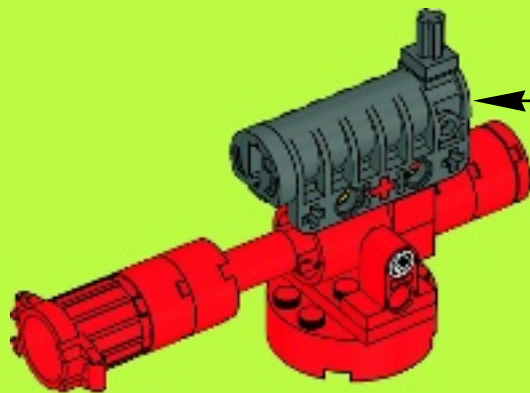
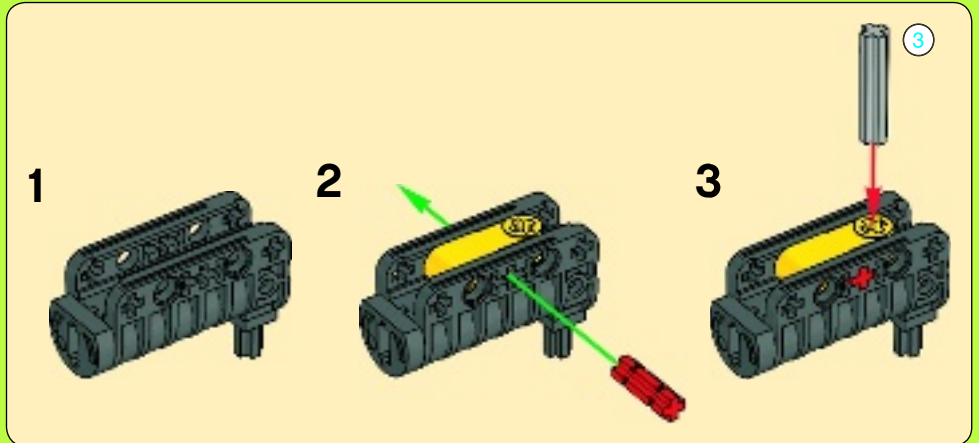

51

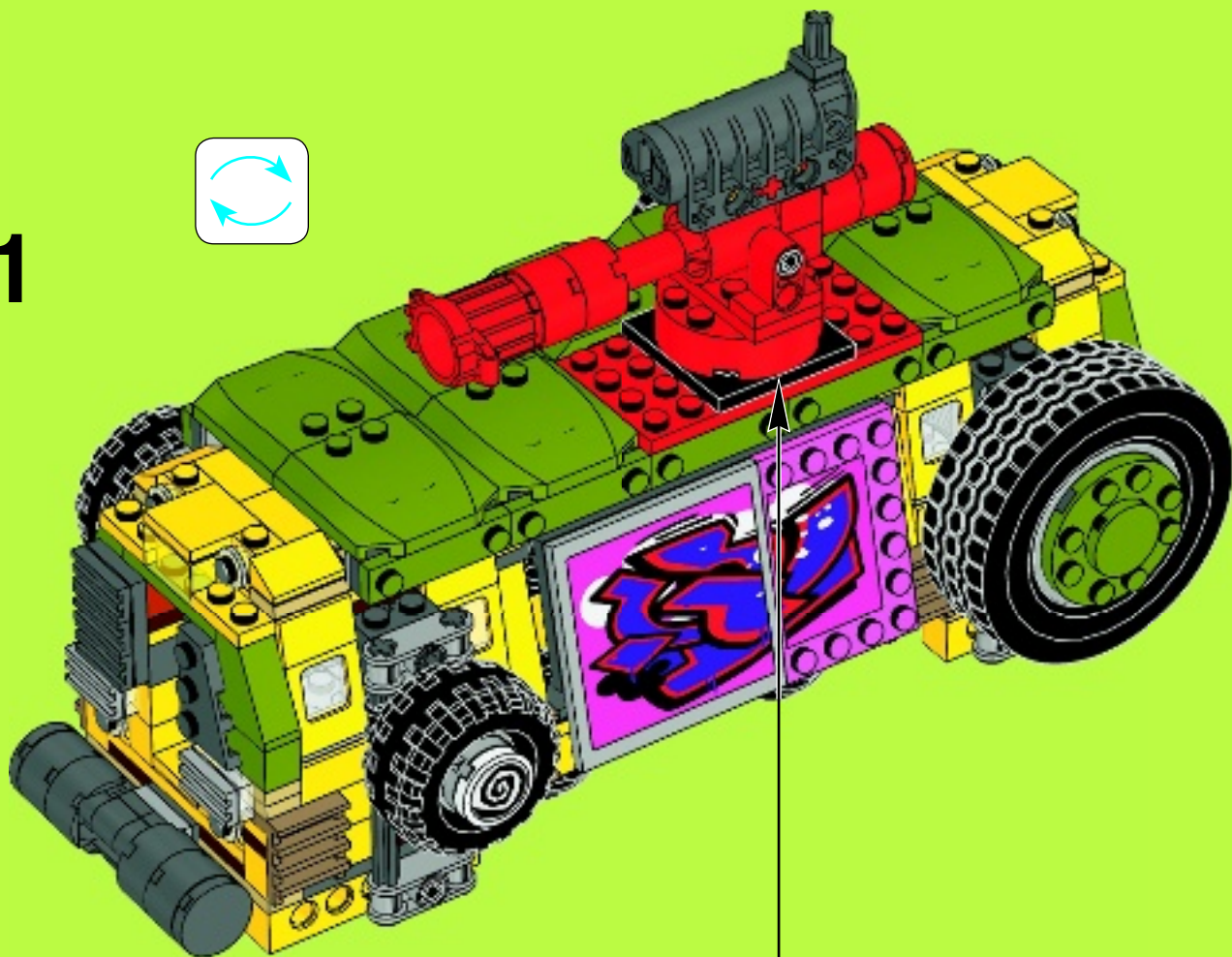

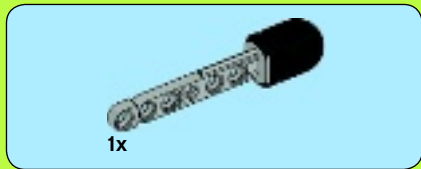

52

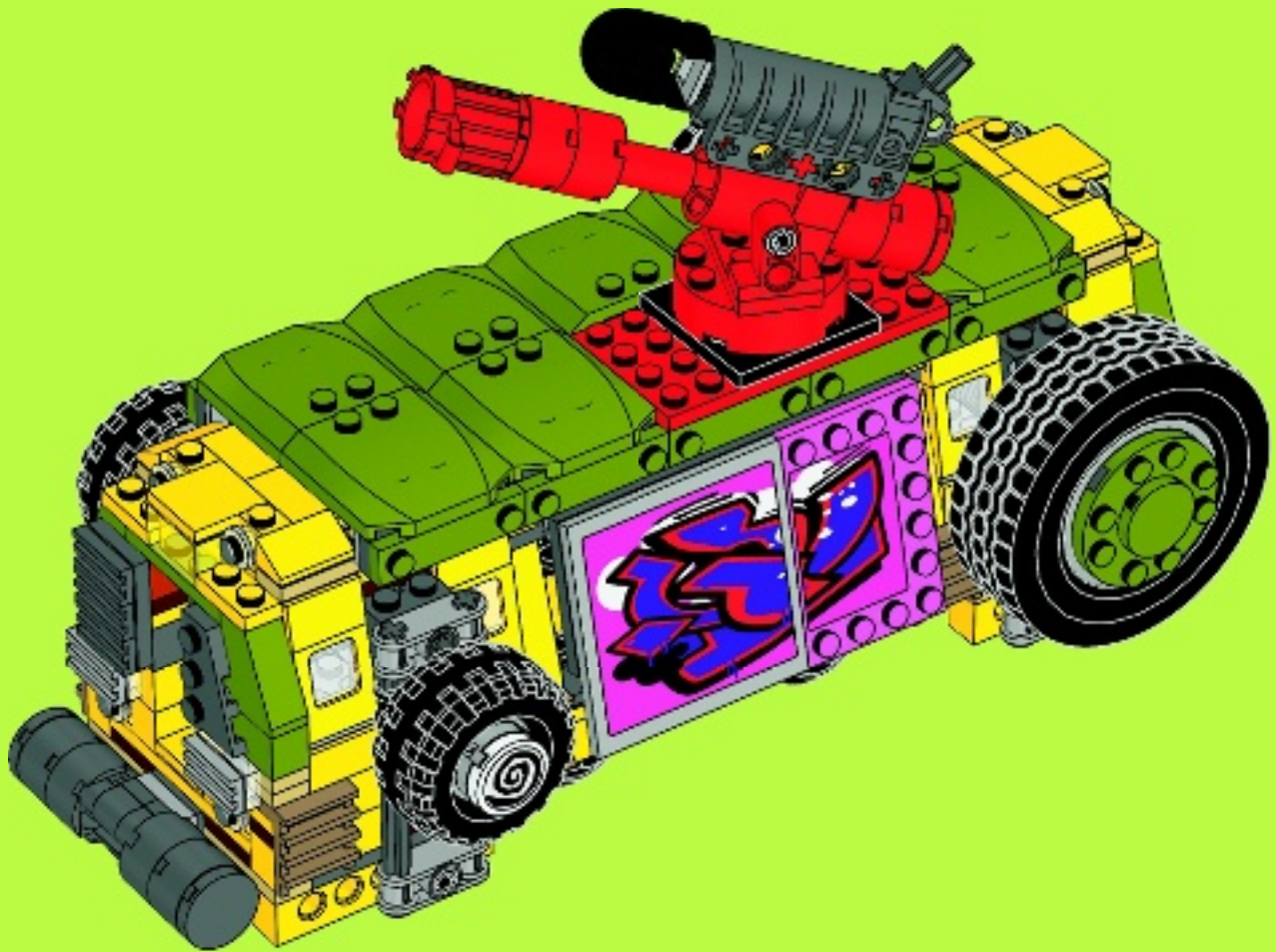

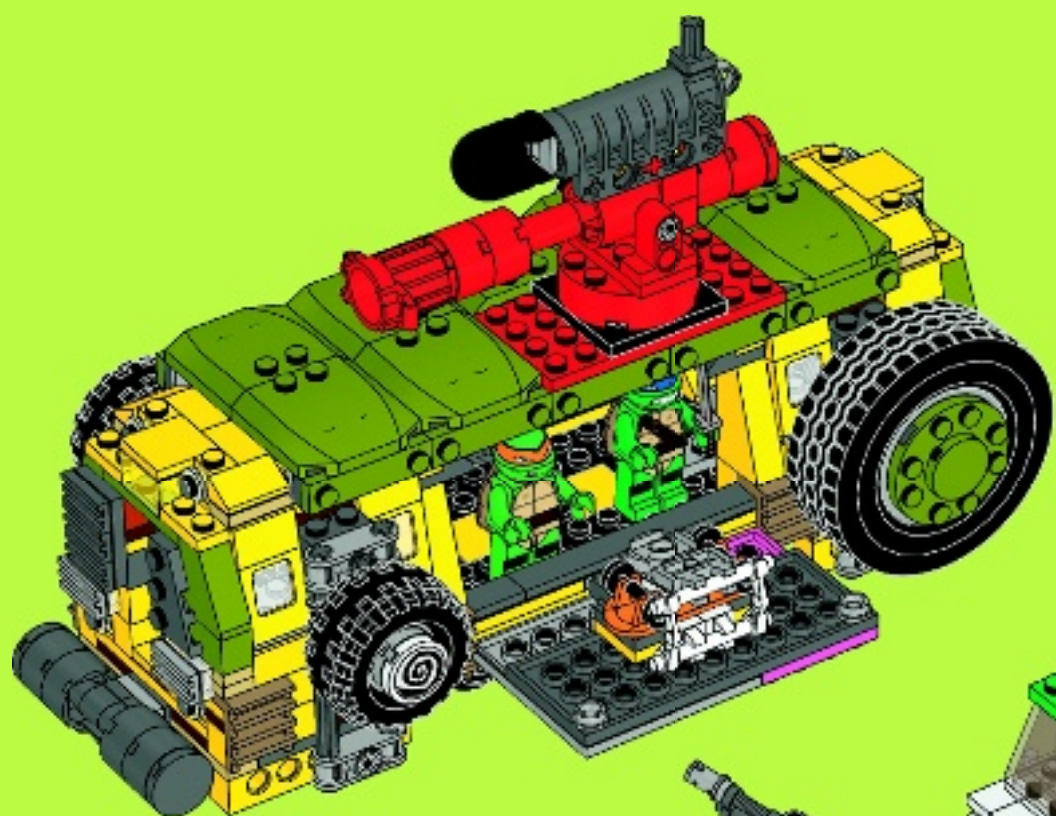

- 6x 362201
- 2x 4119013
- 2x 302401
- 2x 302201
- 2x 4597131
- 2x 6030716
- 4x 415001
- 1x 4293350
- 5x 306901
- 2x 6018774
- 1x 306801
- 1x 4289304
- 3x 4560178
- 1x 4519345
- 1x 4519346
- 2x 4129836
- 2x 4260649
- 8x 4159553
- 6x 4121921
- 1x 4124067
- 4x 4114324
- 1x 4114001
- 2x 4513987
- 4x 614321
- 1x 4244747
- 1x 4610843
- 2x 366521
- 2x 4259678
- 1x 371021
- 4x 302021
- 1x 303521





- 2x 4207715
- 1x 415021
- 1x 6030164
- 1x 4142865
- 1x 4526984
- 1x 4278276
- 2x 4143005
- 16x 300524
- 6x 300424
- 4x 362224
- 1x 301024
- 8x 407024
- 4x 389424
- 10x 4121965
- 4x 6024687
- 21x 302324
- 4x 302224
- 1x 371024
- 13x 366624
- 3x 379524



- 4x 4550348
- 2x 306924
- 4x 306824
- 4x 4560181
- 8x 4521134
- 8x 486524
- 8x 393724
- 1x 4175441
- 2x 4264963
- 4x 4140430
- 2x 4599499
- 1x 302026
- 1x 4277932
- 1x 6020193
- 2x 416226
- 2x 383226
- 1x 6016487

- 1x 6022943
- 2x 300426
- 1x 6030414
- 2x 249626
- 2x 448826
- 2x 292626
- 2x 4295370
- 4x 4496343
- 2x 287826
- 1x 4517986
- 4x 4617848
- 2x 4547373
- 6x 4121715
- 1x 370626
- 2x 4218868
- 2x 4506553



**Customer Service**  
**Kundenservice**  
**Service Consommateurs**  
**Servicio Al Consumidor**  
**LEGO.com/service or dial**

00800 5346 5555 :     

1-800-422-5346 :  





1x  
450731



2x  
302128



1x  
302028



1x  
366628



1x  
6025395



1x  
6024647



1x  
6023042



2x  
6016931



4x  
306928



4x  
4666322



1x  
6030804



1x  
6030807



1x  
6030803



2x  
4167842



10x  
3005740



8x  
6024020



2x  
4201019



2x  
3005741



2x  
306544



2x  
611649



1x  
6030411



1x  
6029901



1x  
6029936



1x  
4654448



1x  
4173328



8x  
6024723



1x  
6023060



1x  
6023062



1x  
6034152



1x  
6029899



2x  
4542673



18x  
4211150



2x  
4211211



2x  
6029774



1x  
4211387



5x  
4211397



2x  
4211396



1x  
6030203



1x  
4211401



1x  
4662161



2x  
4211480



4x  
4211350



4x  
4654582



3x  
4556157



2x  
4211419



6x  
6014615



5x  
4211356



2x  
6014617



19x  
4211525



7x  
4211475



4x  
4211515



1x  
4550170



1x  
4211760



2x  
4226995



8x  
4211470



8x  
4211621



2x  
4551421



1x  
4211483



2x  
4211807



1x  
4211815



1x  
4211639



1x  
4299625



8x  
4558955



2x  
4213574



4x  
4211095



2x  
6019987



4x  
4211046



18x  
4249139



1x  
4567887



4x  
4621917



2x  
4234534



2x  
4211119



1x  
4211043



8x  
4211001



2x  
4211065



3x  
4211134



4x  
4257526

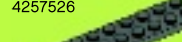

1x  
4210678

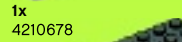

2x  
4211122



2x  
4211008



6x  
4587212



2x  
4620079



4x  
4210631



2x  
4211052



1x  
4277928



1x  
6000606

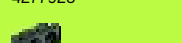

4x  
4521187



2x  
4210869



1x  
4210872



2x  
4211039



1x  
4623236



1x  
4600437



2x  
4560177



8x  
4499858



1x  
4518308

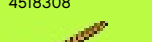

1x  
4614404

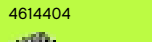

2x  
4619636

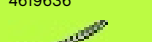

2x  
4612900

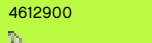

1x  
4612901

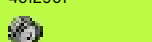

4x  
4624473



2x  
4298979



6x  
6024722



4x  
6024692



10x  
6024727

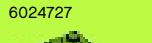

2x  
6020144



2x  
6024665

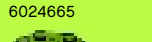

2x  
6024666



8x  
6024696



2x  
6024672



1x  
6030246



1x  
6023047

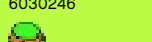

1x  
6025366



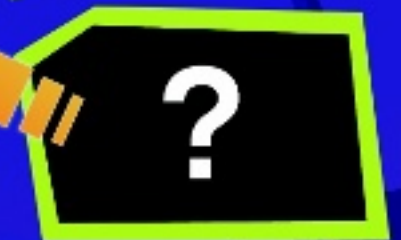

[LEGO.COM/TURTLES](http://LEGO.COM/TURTLES)

79104



79100



79102



79101



79103



79105





79100



79100



79100



79101



79101



79101



79102



79102



79102



79103



79103



79103



79103



79103



79104



79104



79104



79104



79104



79105



79105



79105



79105



nickelodeon.  
**TEENAGE MUTANT NINJA  
TURTLES**

1



[www.LEGOclub.com/Max](http://www.LEGOclub.com/Max)



club

FREE\*! GRATIS! GRATUIT!

[www.LEGOclub.com/Max](http://www.LEGOclub.com/Max)

2



3



\*Paid subscription in Australia and New Zealand.  
\*Abonnement payant en Australie et Nouvelle-Zélande.



# WIN!

Go to [www.LEGOsurvey.com/product](http://www.LEGOsurvey.com/product) to fill out a survey for a chance to win a cool LEGO® Product.

No purchase necessary.

Open to all residents where not prohibited.



LEGO.com



## [www.LEGOsurvey.com/product](http://www.LEGOsurvey.com/product)

### GEWINNE!

Nimm an der Umfrage auf [www.LEGOsurvey.com/product](http://www.LEGOsurvey.com/product) teil und hab die Chance ein cooles LEGO® Produkt zu gewinnen!  
Die Teilnahme am Gewinnspiel führt zu keinerlei Kaufverpflichtungen. Teilnahme in allen nicht ausgeschlossenen Ländern möglich.

### WIN!

Ga naar [www.LEGOsurvey.com/product](http://www.LEGOsurvey.com/product), vul een enquêteformulier in en maak kans op een cool LEGO® product.  
Geen aankoopverplichting.  
Iedereen mag deelnemen, uitzonderd ingezetenden van landen waar een enquêteverbod geldt.

### GAGNE!

Visite [www.LEGOsurvey.com/product](http://www.LEGOsurvey.com/product) pour répondre à un questionnaire et avoir une chance de gagner un produit LEGO® très cool!  
Aucune obligation d'achat.  
Ouvert à tous les résidents des pays autorisés.

### 当てよう!

[www.LEGOsurvey.com/product](http://www.LEGOsurvey.com/product) にアクセスして、アンケートにご記入ください。当選者にはレゴ®製品を差し上げます。  
お買い上げの必要はありません。  
禁止されていない限り、すべての皆様にご利用いただけます。