

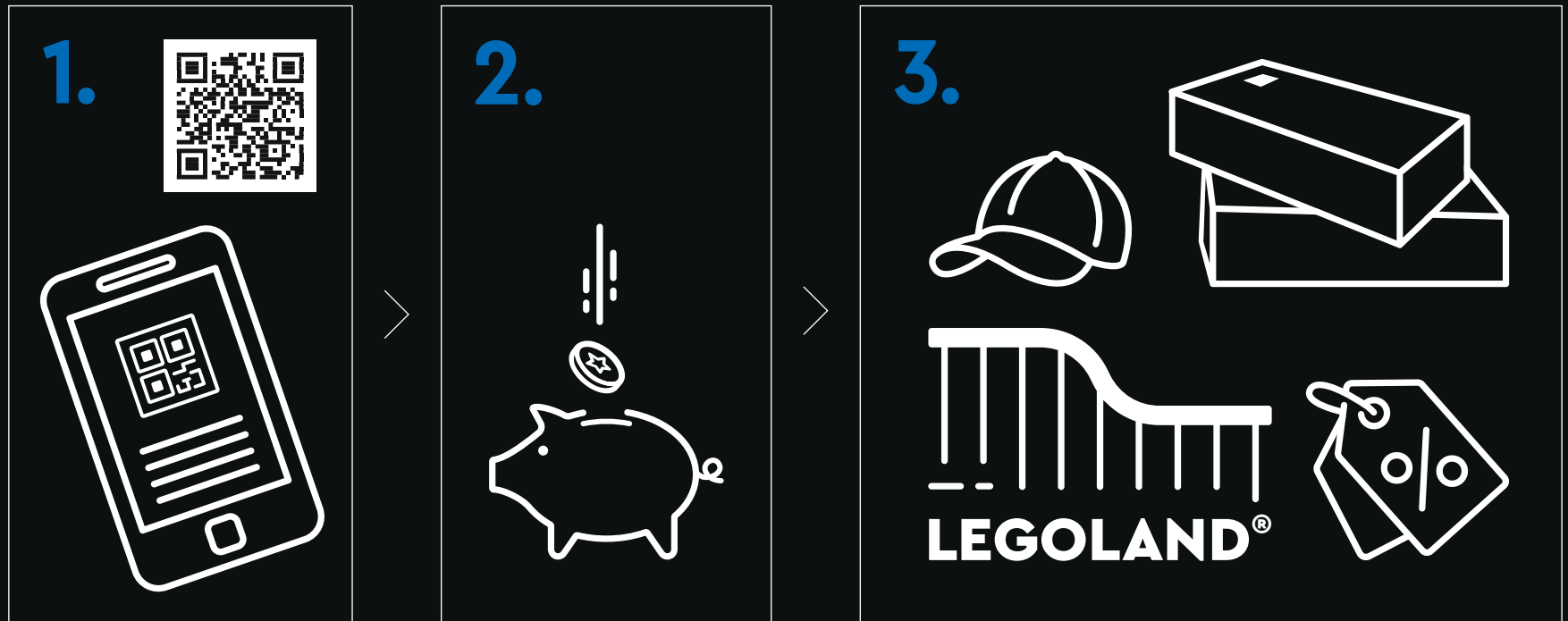



[LEGO.com/sustainable-packaging](https://www.lego.com/sustainable-packaging)

LEGO® VIP



1. Sign up **2.** Earn points for purchases **3.** Redeem points for rewards, experiences, discounts & more | **1.** Melde dich an **2.** Sammle Punkte bei jedem Kauf **3.** Löse die Punkte für Belohnungen, Erlebnisse, Rabatte und Ähnliches ein | **1.** Inscrivez-vous **2.** Gagnez des points lors de vos achats **3.** Échangez vos points contre des récompenses, des expériences, des remises et bien plus encore | **1.** Iscriviti **2.** Guadagna punti con i tuoi acquisti **3.** Riscatta punti per premi, esperienze, sconti e altro ancora | **1.** Regístrate **2.** Gana puntos por tus compras **3.** Canjea puntos por recompensas, experiencias, descuentos y mucho más | **1.** Registe-se **2.** Ganhe pontos em compras **3.** Troque os pontos para prémios, experiências, descontos e muito mais | **1.** 注册 **2.** 购物赚积分 **3.** 用积分兑换奖励、体验、折扣等 | **1.** Zarejestruj się **2.** Zdobywaj punkty za zakupy **3.** Wymieniaj punkty na rabaty, przygody i inne nagrody | **1.** Zaregistrujte se **2.** Sbírejte body za nákupy **3.** Vyměňujte body za odměny, zážitky, slevy a spoustu dalšího | **1.** Zaregistrujte se **2.** Získavajte body za nákupy **3.** Uplatnite si body a získajte odmeny, rôzne zážitky, zľavy a ešte viac | **1.** Regisztrálj **2.** Szerezz pontokat minden vásárlással **3.** Váltsd be pontjaidat jutalmakra, élményekre, kedvezményekre és egyebekre | **1.** Înscrite-te **2.** Câștigă puncte pentru achiziții **3.** Valorifică puncte pentru recompense, experiențe, reduceri și multe altele | **1.** Регистрируйте се **2.** Получайте точки за покупки **3.** Используйте точки за награды, услуги, отстъпки и т.н. | **1.** Reģistrējies **2.** Pelni punktus par pirkumiem **3.** Izmanto punktus, lai saņemtu balvas, izklaides iespējas, atlaides un daudz ko citu | **1.** Registreeru **2.** Teeni ostude eest punkte **3.** Lunasta punktide eest preemiad, elamused, allahindlused ja muu | **1.** Užsiregistruokite **2.** Pelnykite taškų už pirkinius **3.** Panaudokite taškus atlygiui, funkcijoms, nuolaidoms ir ne tik





姫路城

CASTELLO DI HIMEJI / IL CASTELLO AIRONE BIANCO

🌸 Il Castello di Himeji, che domina maestosamente la città giapponese di Himeji, è un gioiello architettonico che è stato inserito nell'elenco dei Patrimoni Umani dell'UNESCO. Costruito come fortezza nel 1333, alla fine di un'epoca di guerre civili, il castello ha subito diverse trasformazioni nel corso dei secoli. Nel 1600, fu avviato un'importante progetto di ricostruzione che portò all'attuale struttura, conservata nella sua integrità fino a oggi, inizialmente dai padroni feudali e successivamente dal governo giapponese. Labirinti di percorsi intricati, un tempo progettati per confondere e intrappolare i nemici, oggi tessono un viaggio intrigante per i visitatori. Attraverso guerre, terremoti, incendi e periodi di pace, il Castello Airone Bianco si erge come un sereno monumento alla cultura giapponese. Scopri gli intricati dettagli del maschio principale e la storia del castello mentre lo costruisci.

CHRIS MCVEIGH
LEGO® Senior Designer

UN TRIBUTO A UN PUNTO DI RIFERIMENTO VENERATO

🌸 "Nel 2023, ricorre il 30° anniversario dell'iscrizione del Castello di Himeji nell'elenco dei Patrimoni dell'Umanità dell'UNESCO, e la sua architettura e la sua storia sono ancora un mistero da decifrare. Abbiamo creato il maschio principale come punto focale naturale e abbiamo giocato con le proporzioni e la scala per metterlo in risalto. Chi ha visitato il castello, riconoscerà alcuni degli interni e, se non ci è mai stati, ci auguriamo che accenderà l'immaginazione e la curiosità nei confronti di questo straordinario edificio".



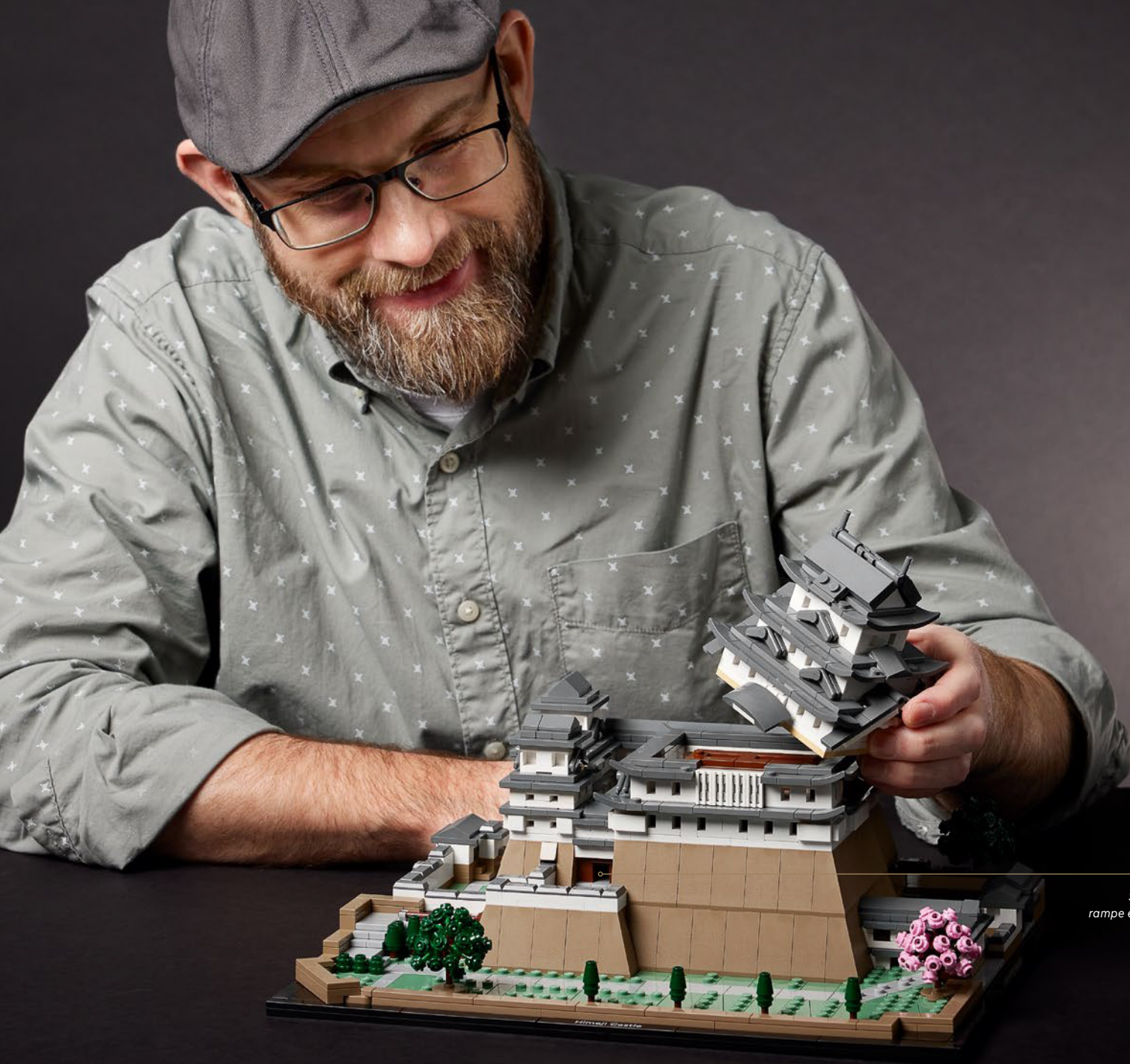

*Segui alcuni degli intricati percorsi,
rampe e scale che attraversano il castello.*



UN'ILLUSIONE OTTICA

Il metodo di copertura del castello di Himeji prevede l'utilizzo di tegole nere rettangolari e semicircolari a incastro. Diversi strati di argilla bianca rivestono le tegole, conferendo alla copertura un aspetto a rete ad alto contrasto, se osservata da vicino. Tuttavia, da lontano, la rete appare grigia. Le tegole di questo set sono di colore *grigio pietra scuro* per rispecchiare l'invecchiamento delle tegole.



Sbircia all'interno dopo la costruzione del modello.



Ogni torre è costruita in modo diverso, anche in altezza.



Gli angoli irregolari sono predominanti in tutto il castello e nelle mura.

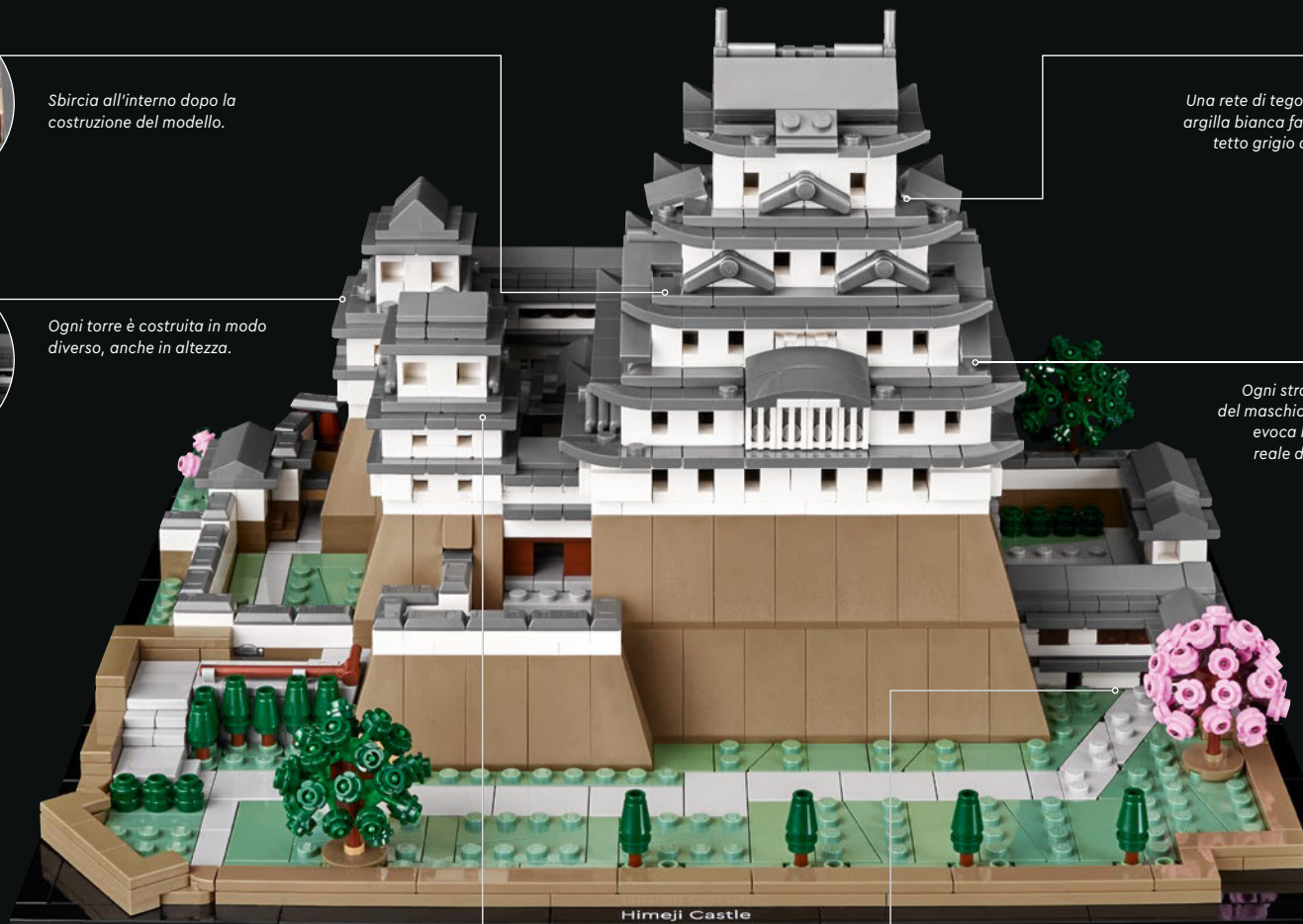

Himeji Castle

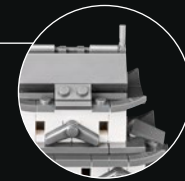

Una rete di tegole nere e di argilla bianca fa apparire il tetto grigio da lontano.

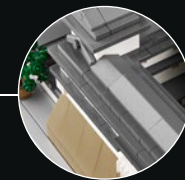

Ogni strato o piano del maschio principale evoca la struttura reale del castello.



Decora i ciliegi con fiori rosa o foglie verdi.

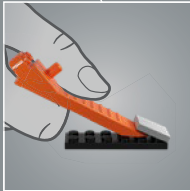
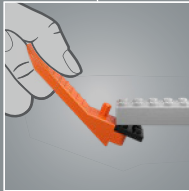
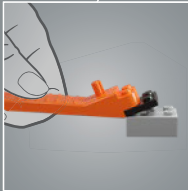
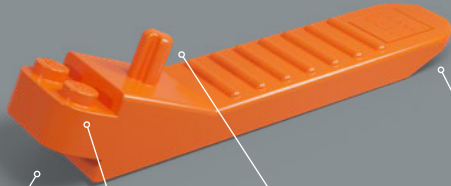

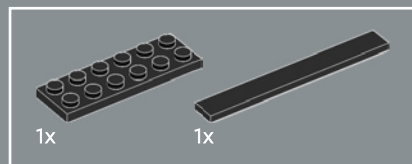

1

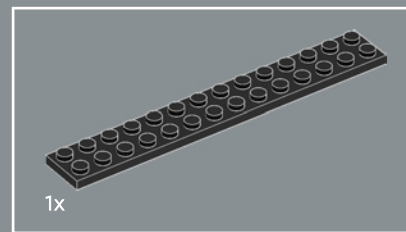
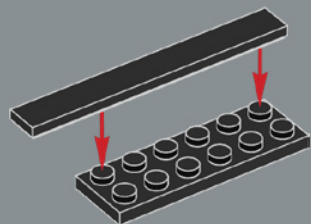

2

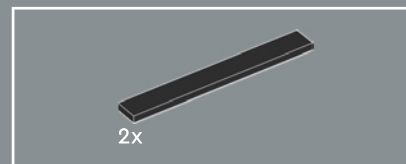
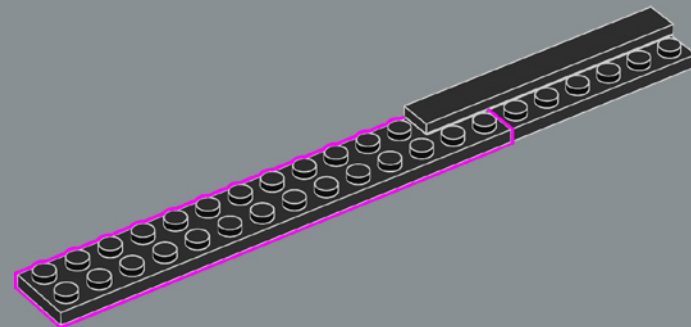

3

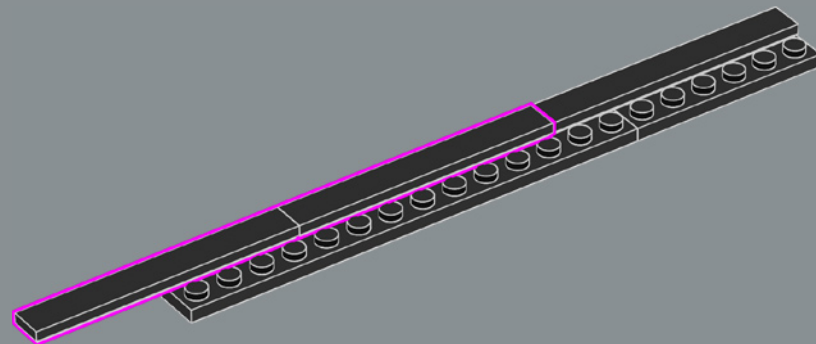

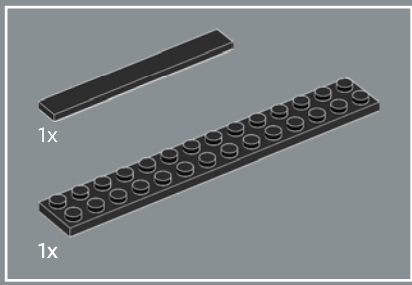

4

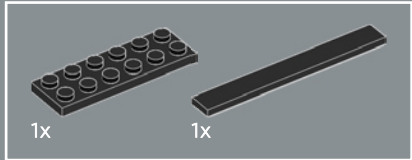
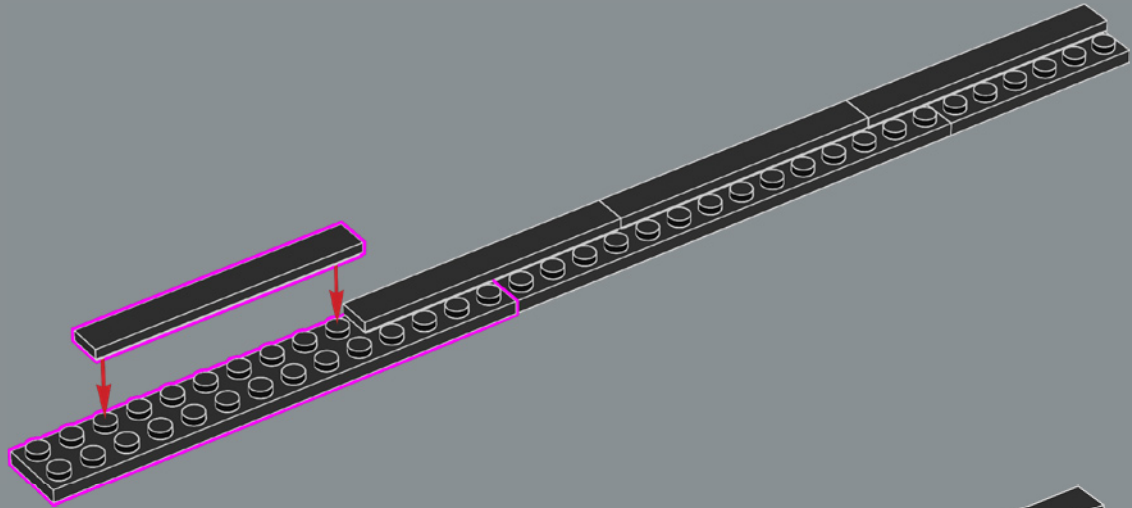

5

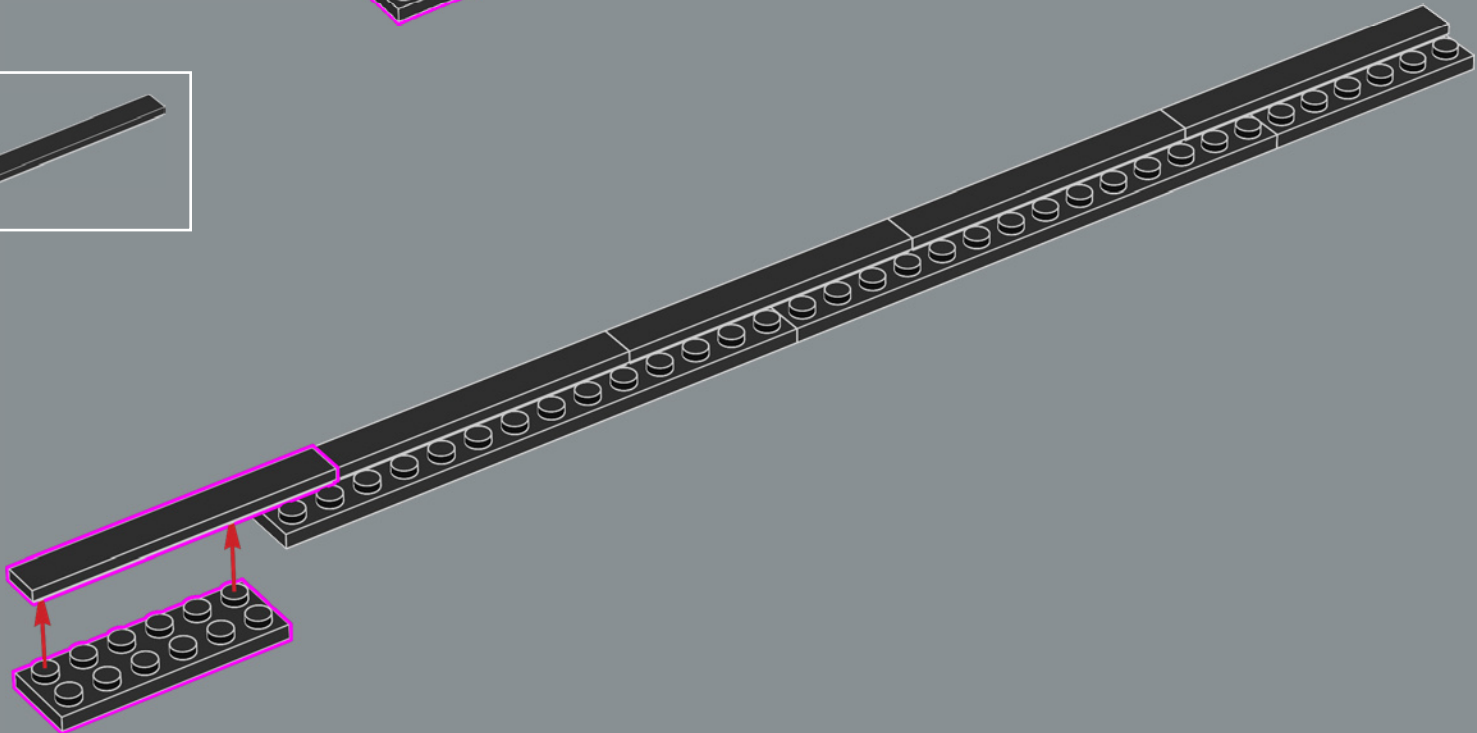

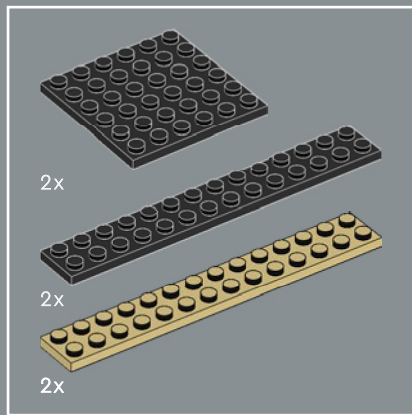

6

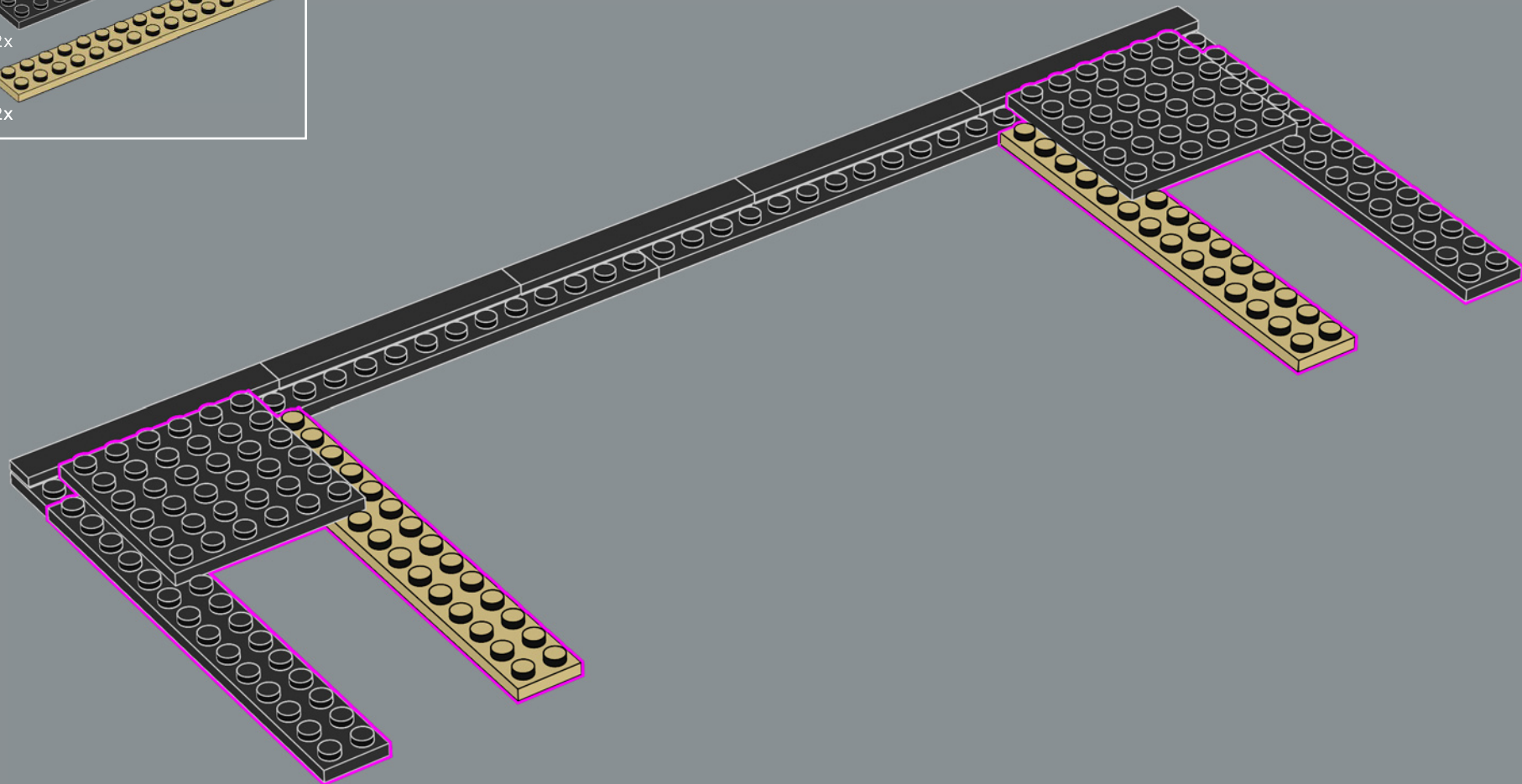

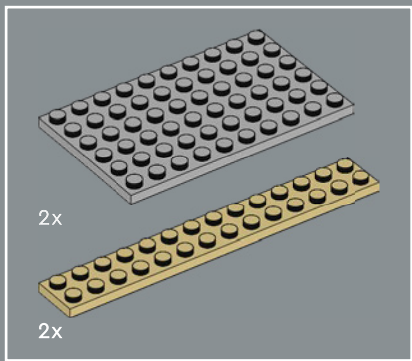

7

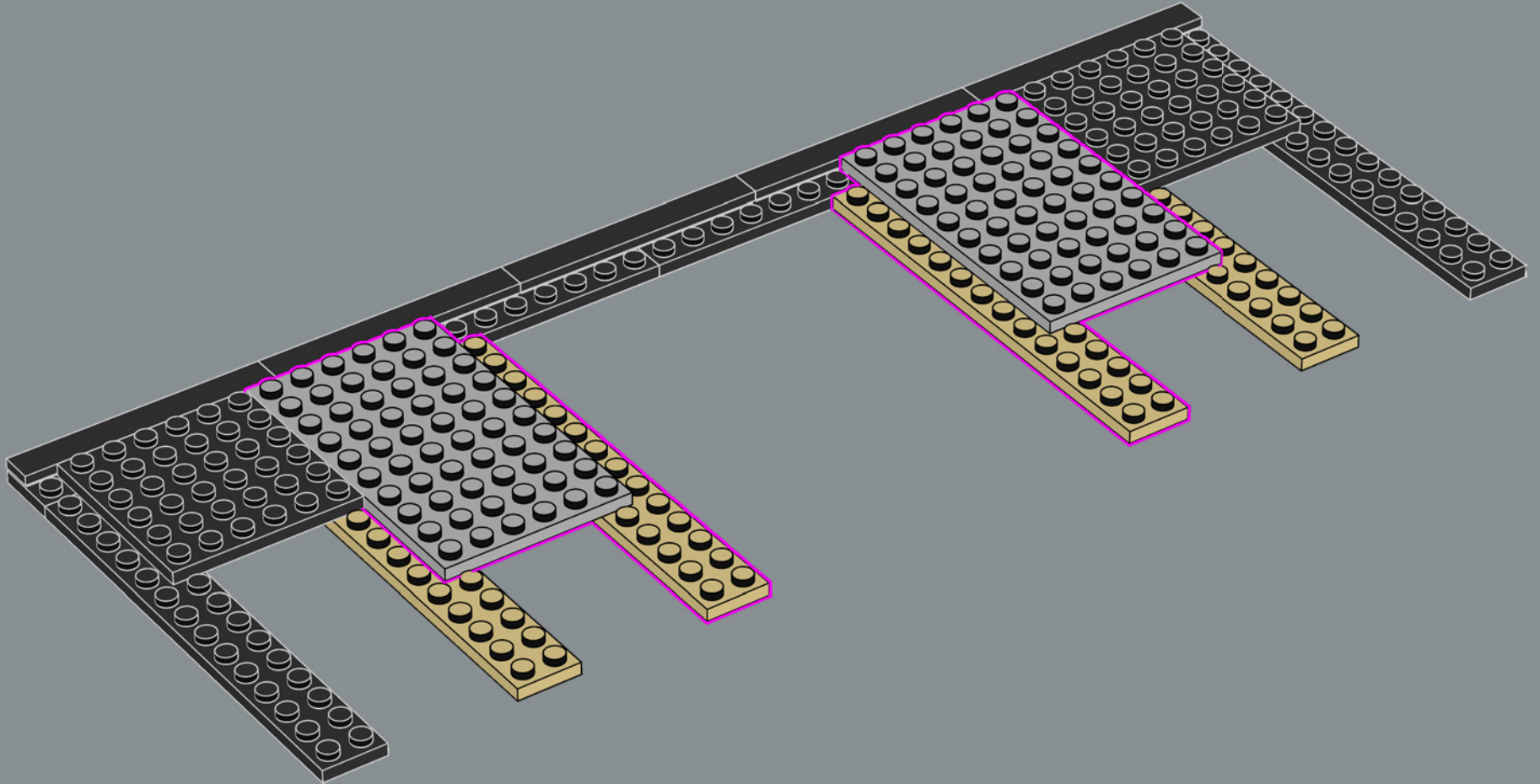

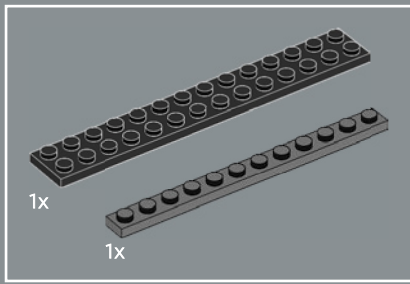

8

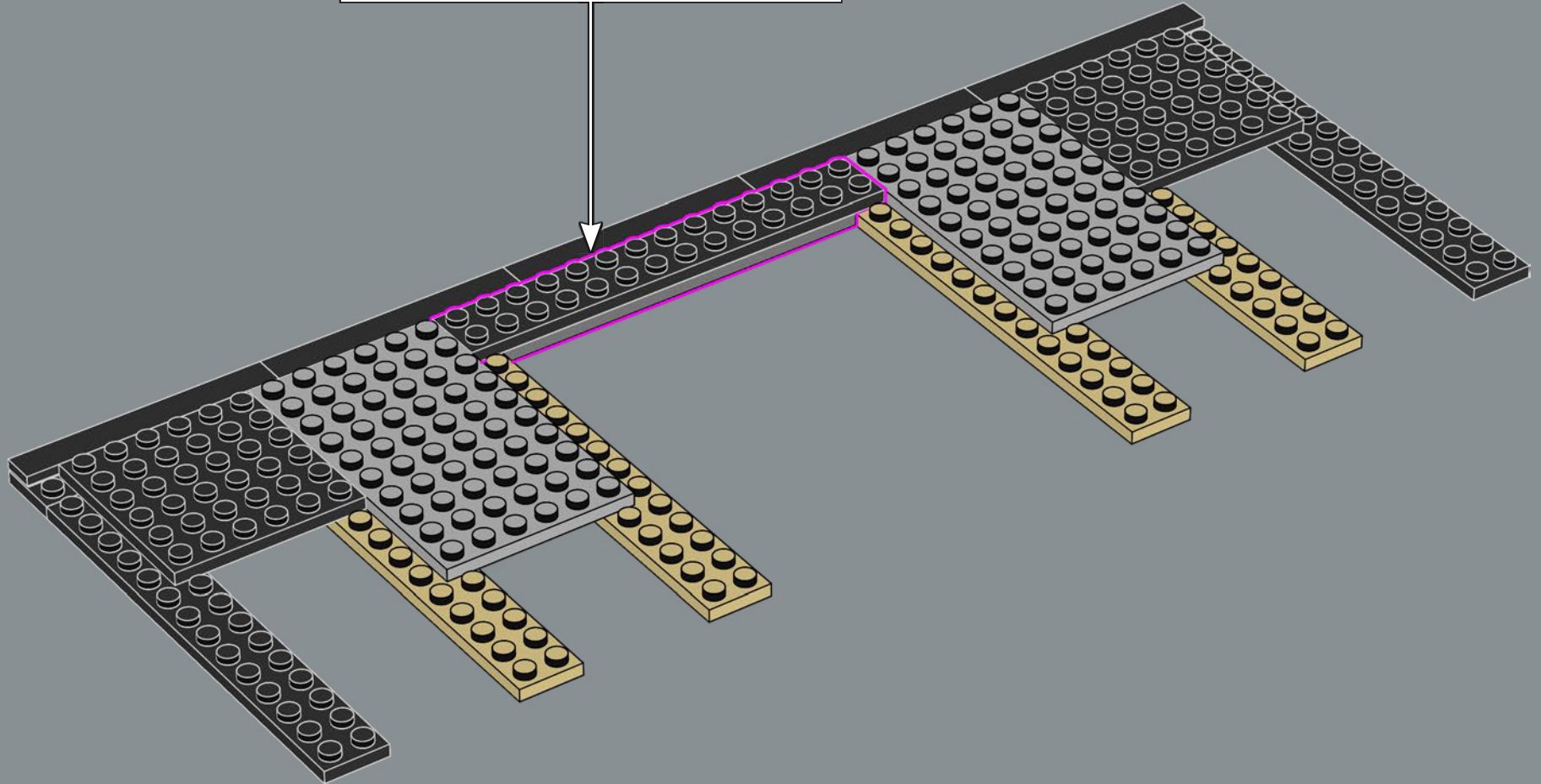
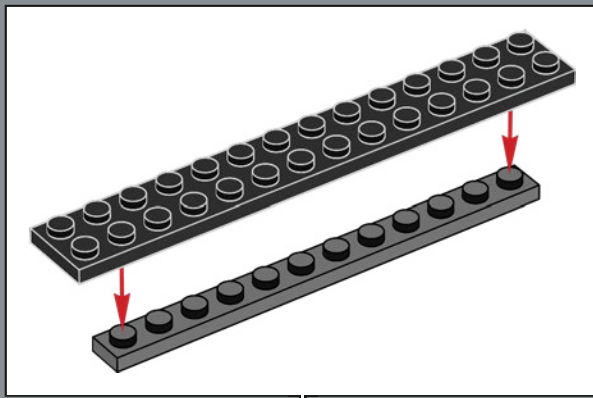

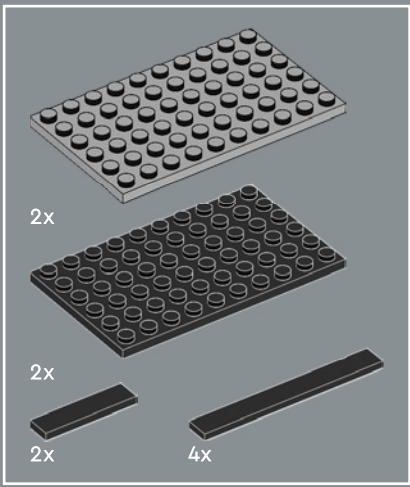

9

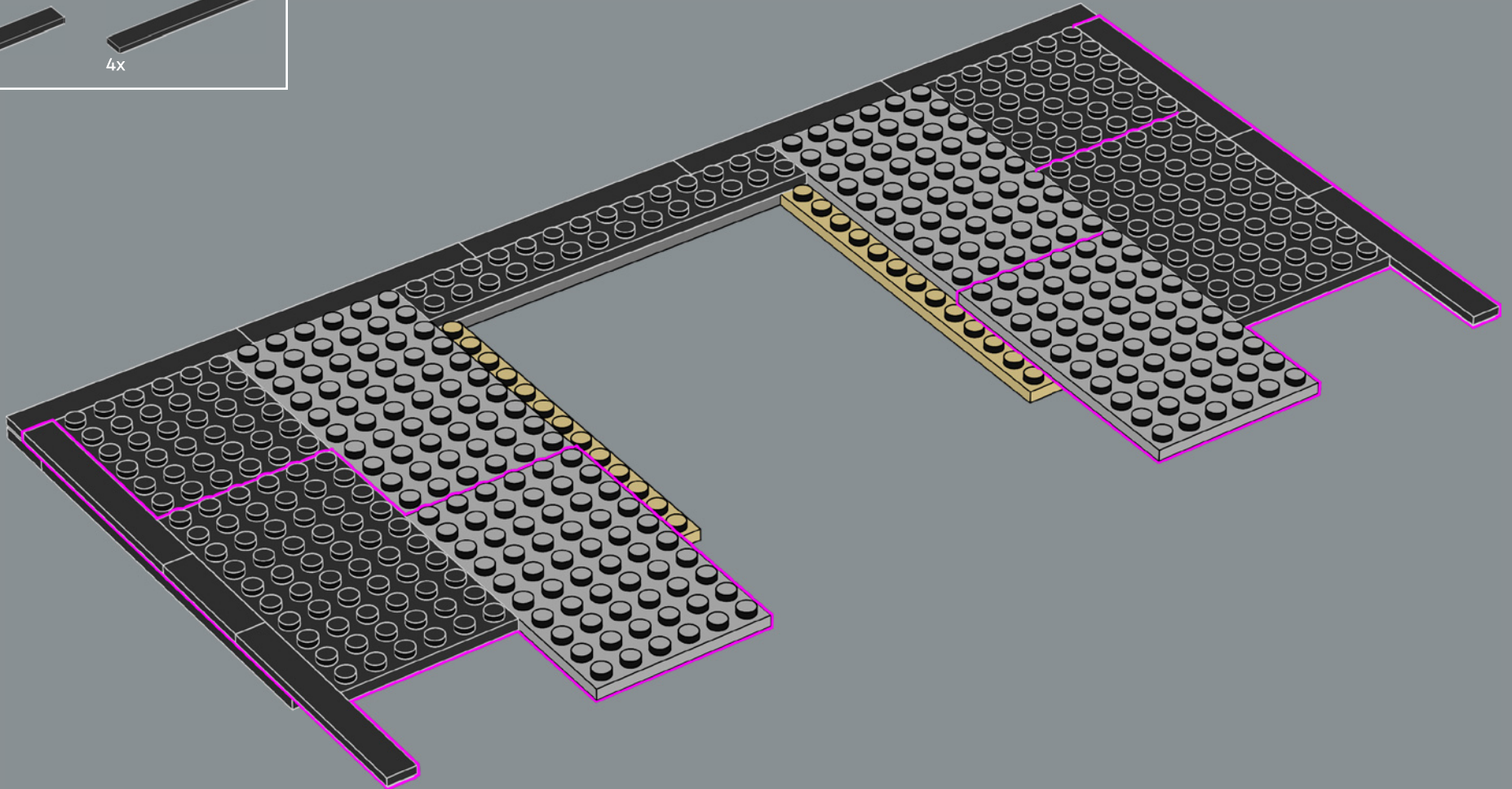

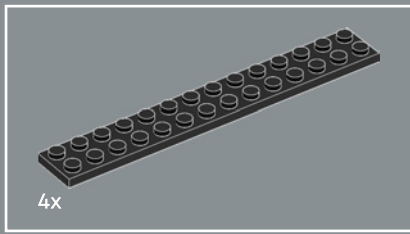

10

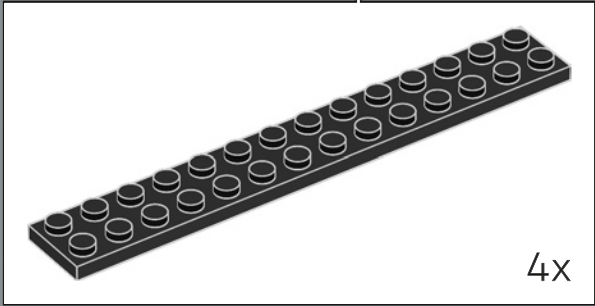
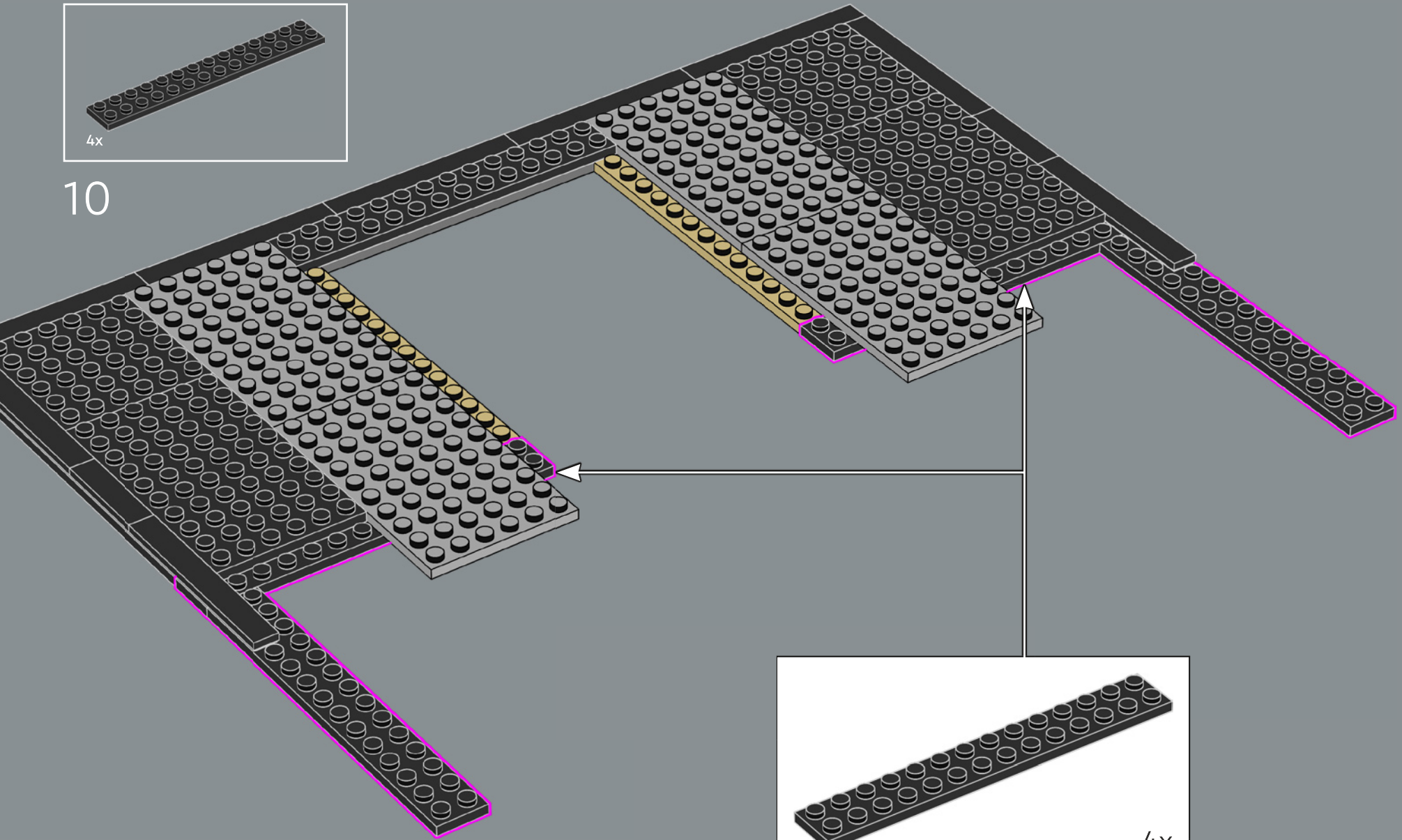

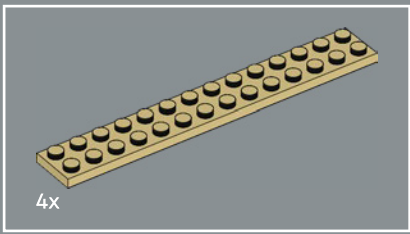

11

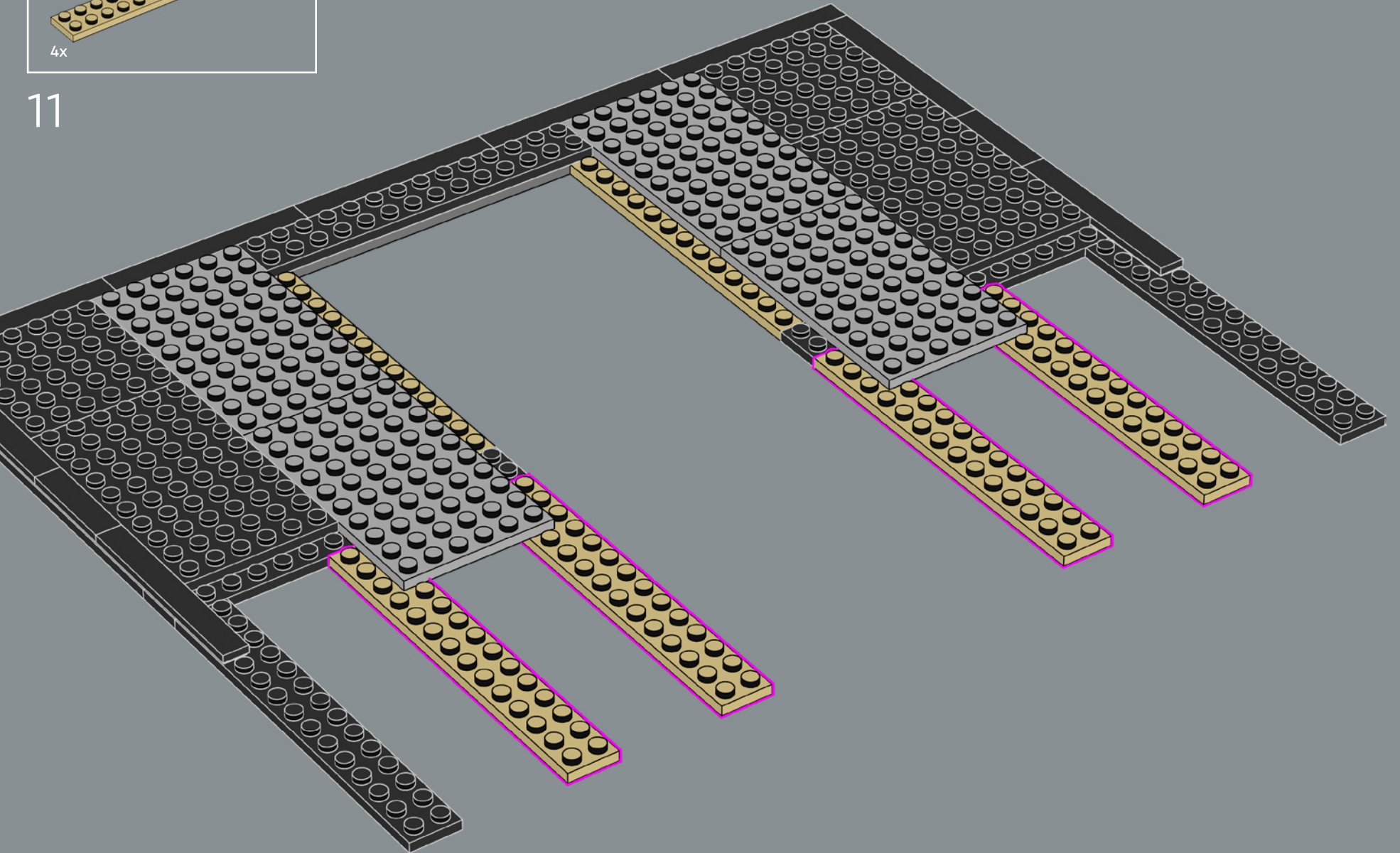

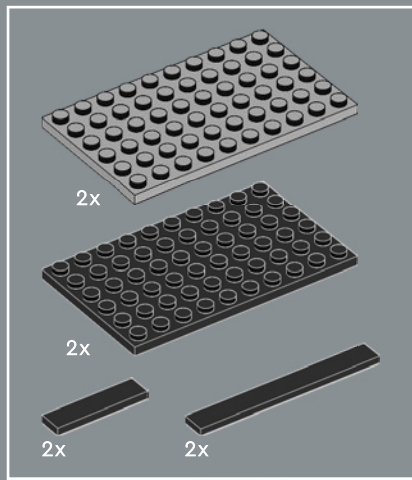

12

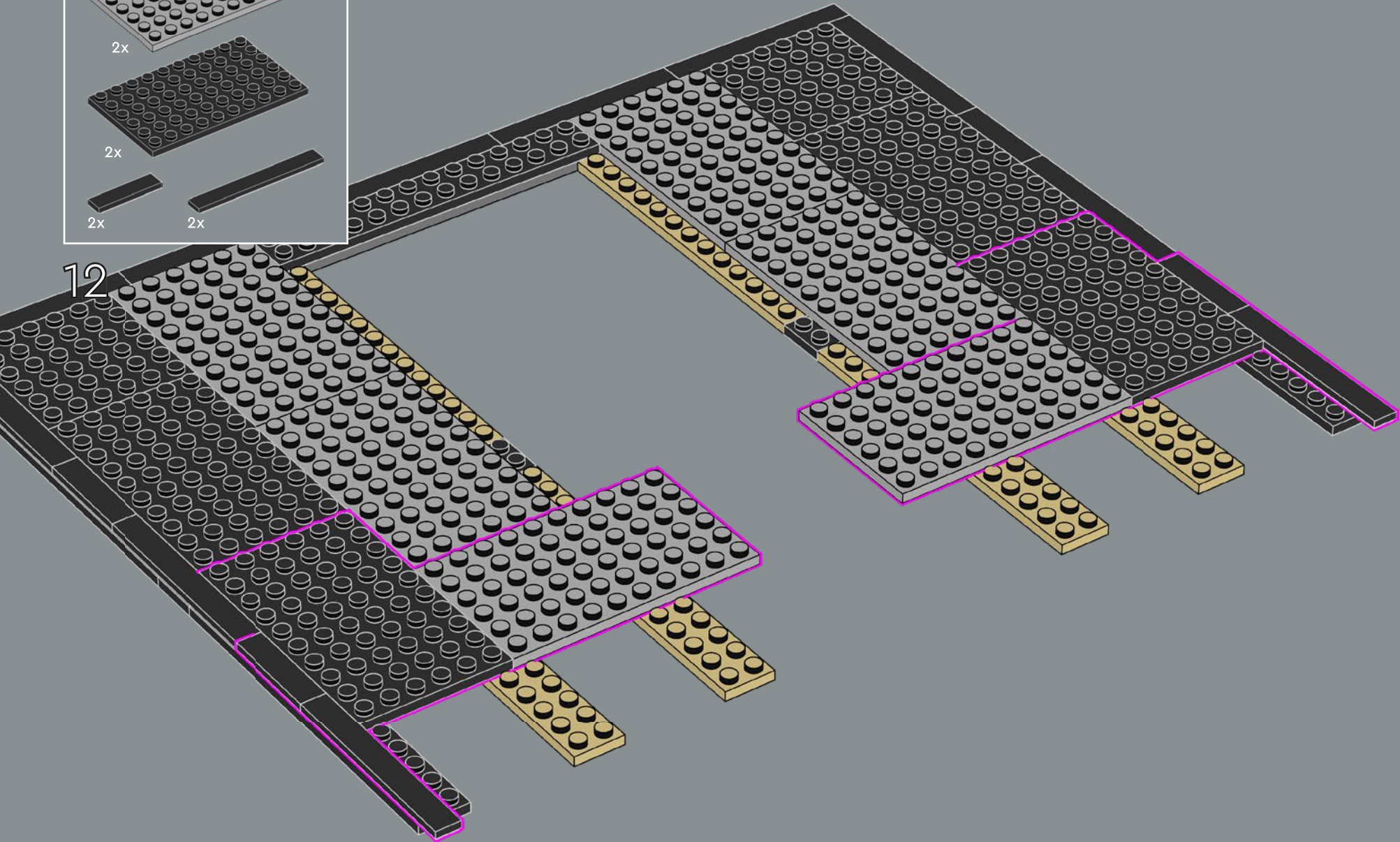

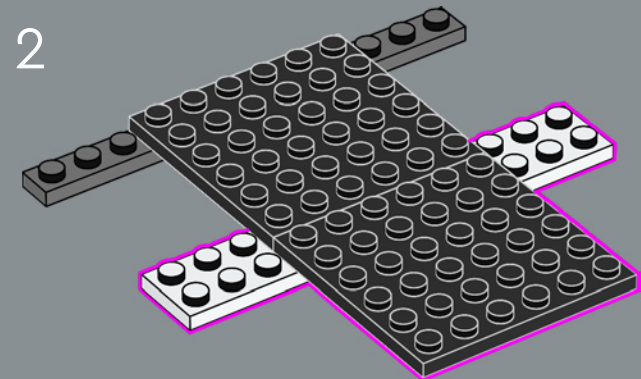
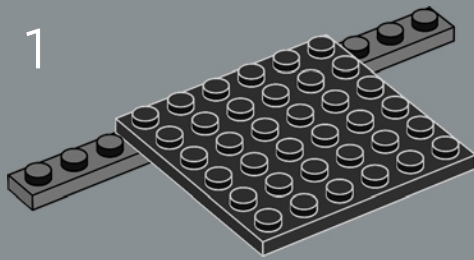
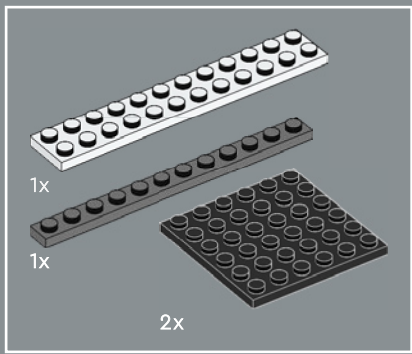

13

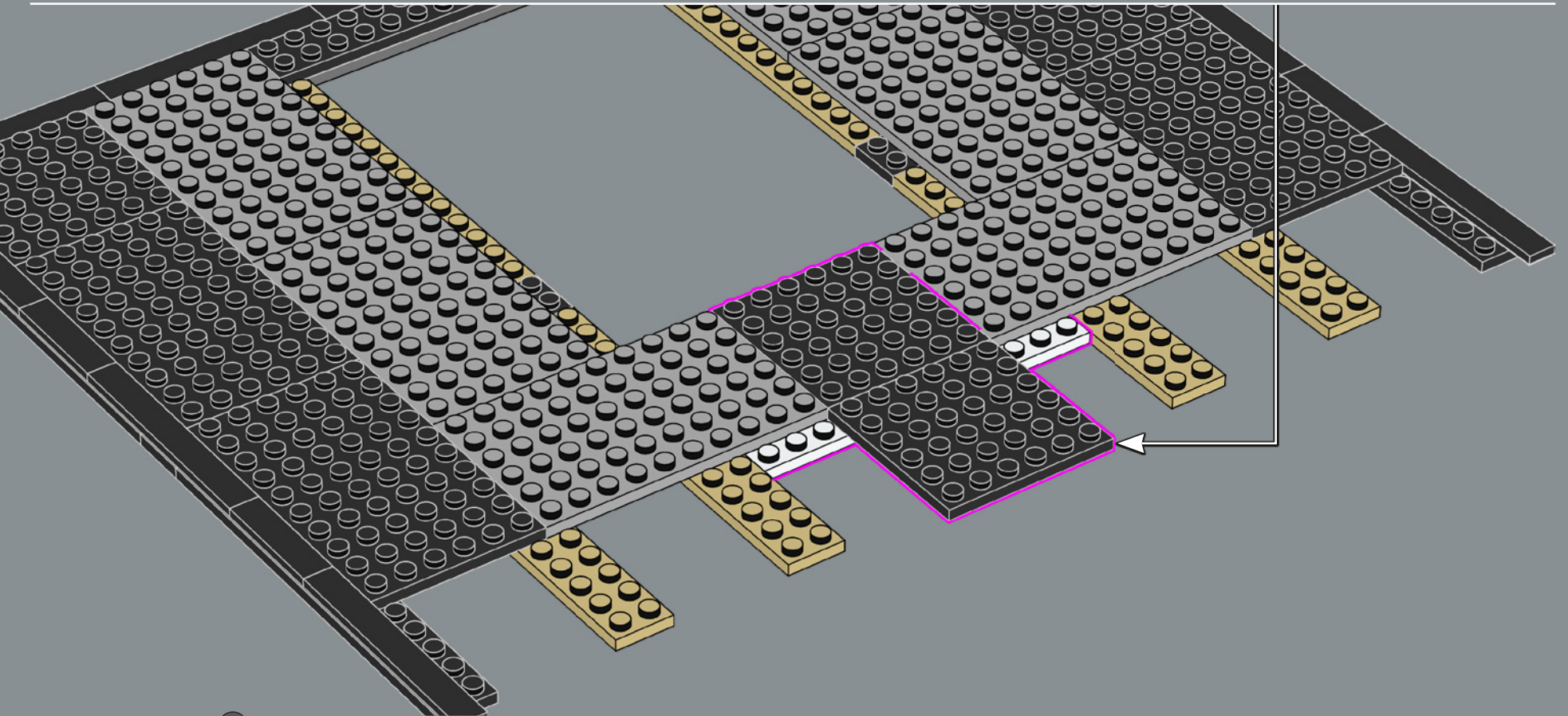

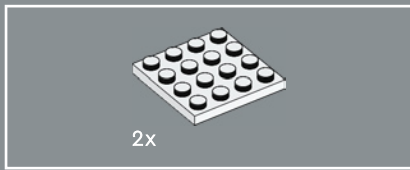

14

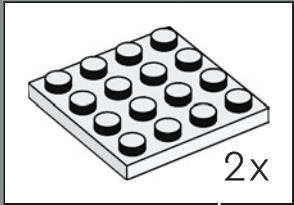
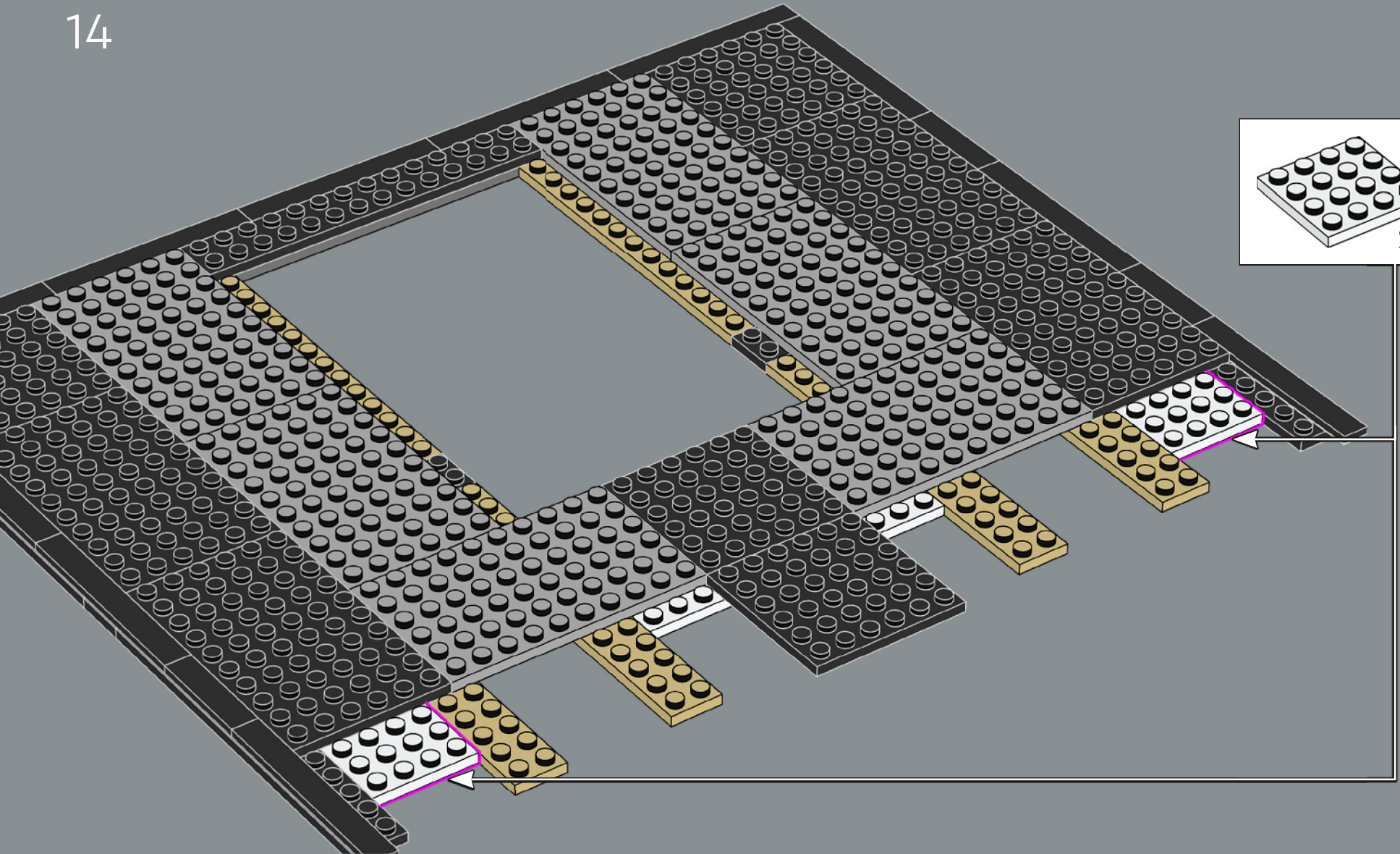

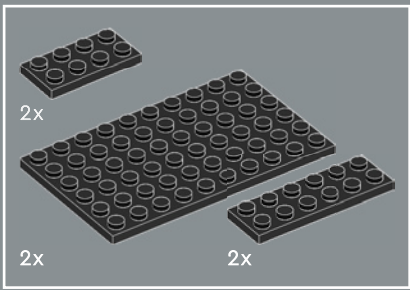

15

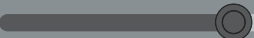
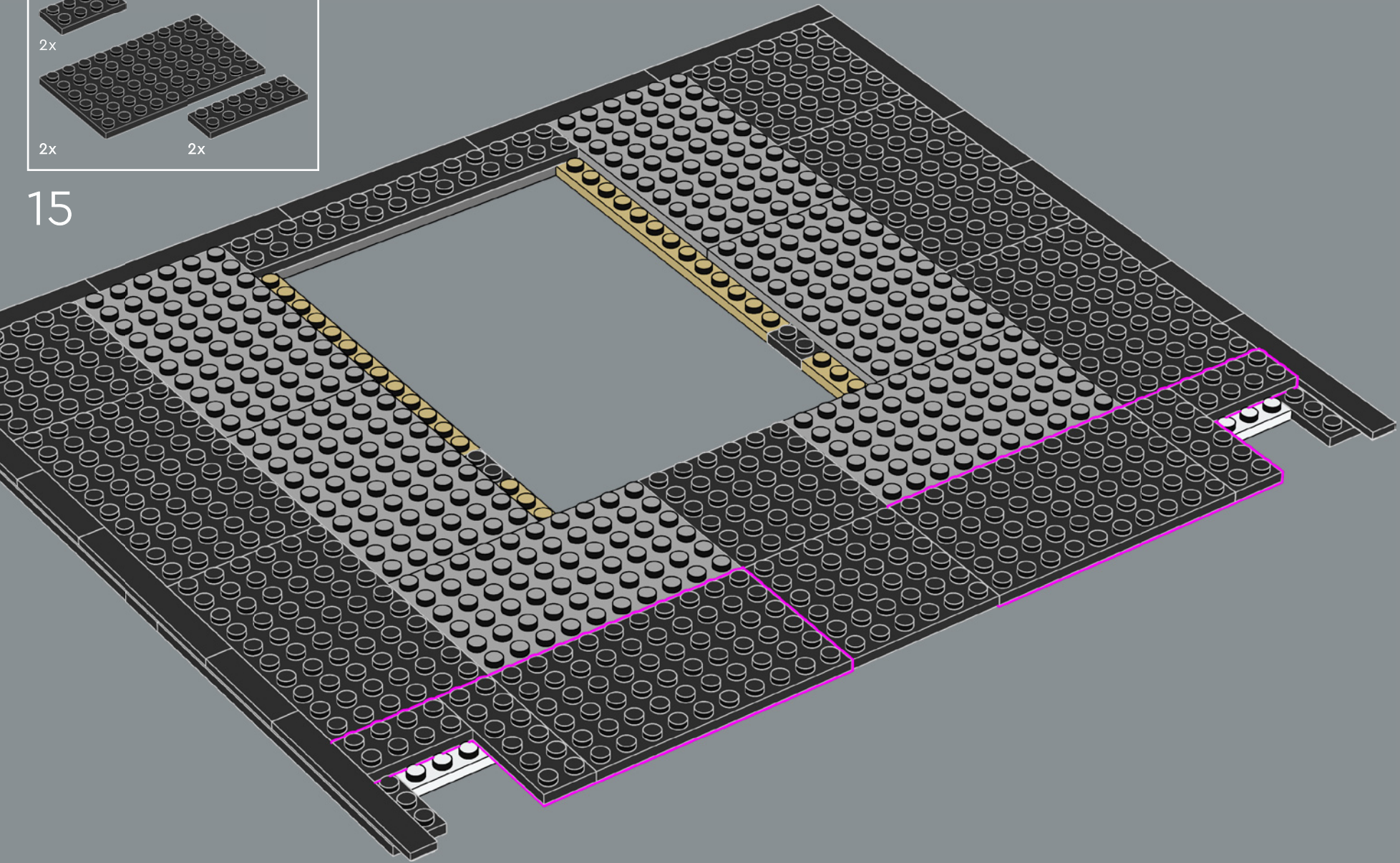

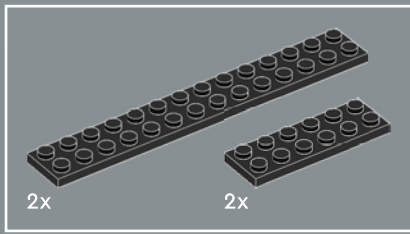

16

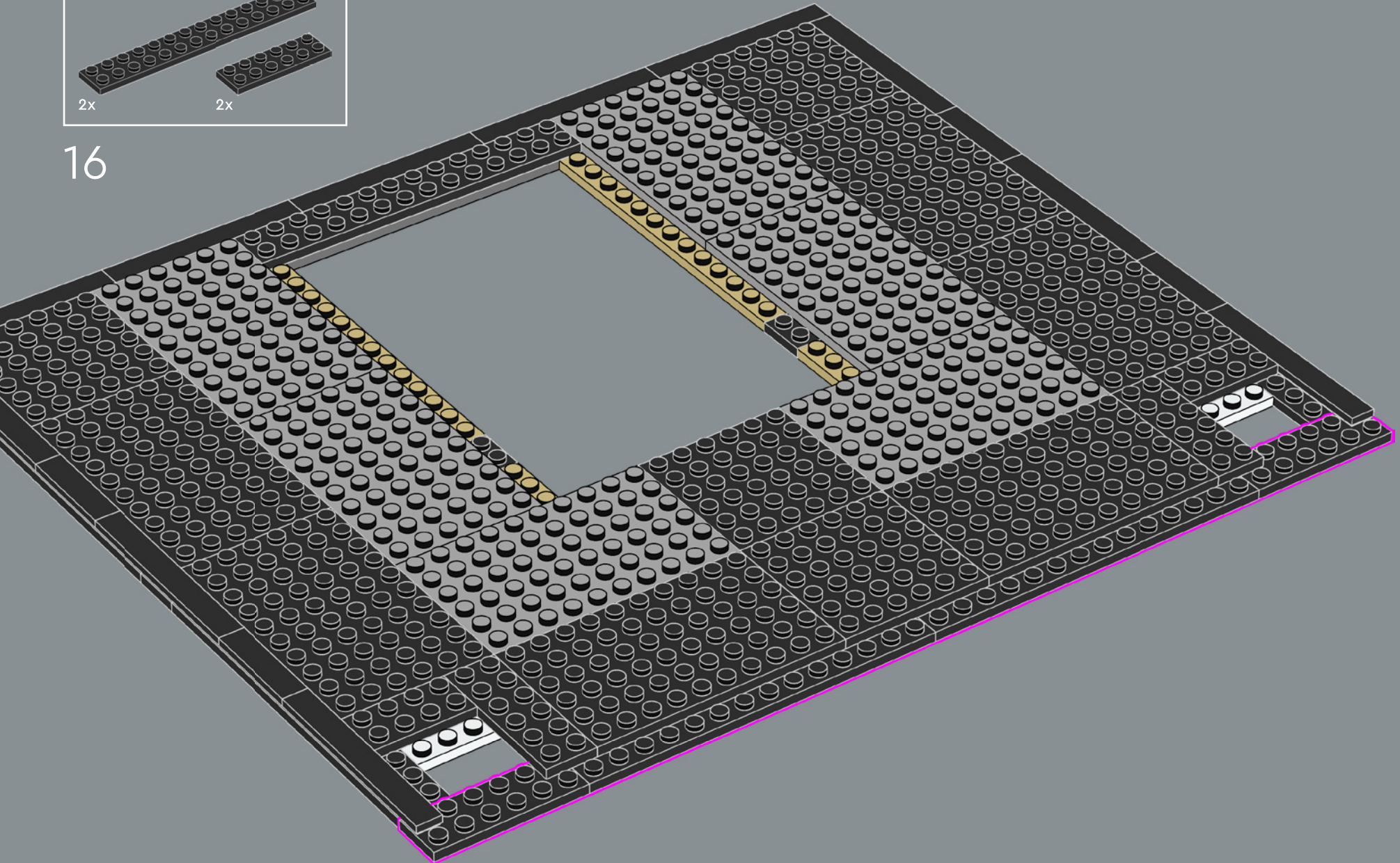

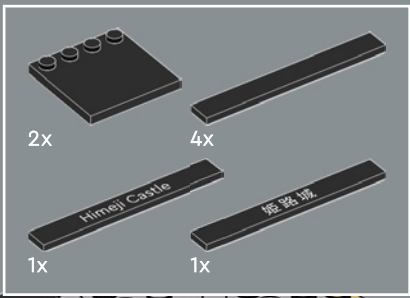

17

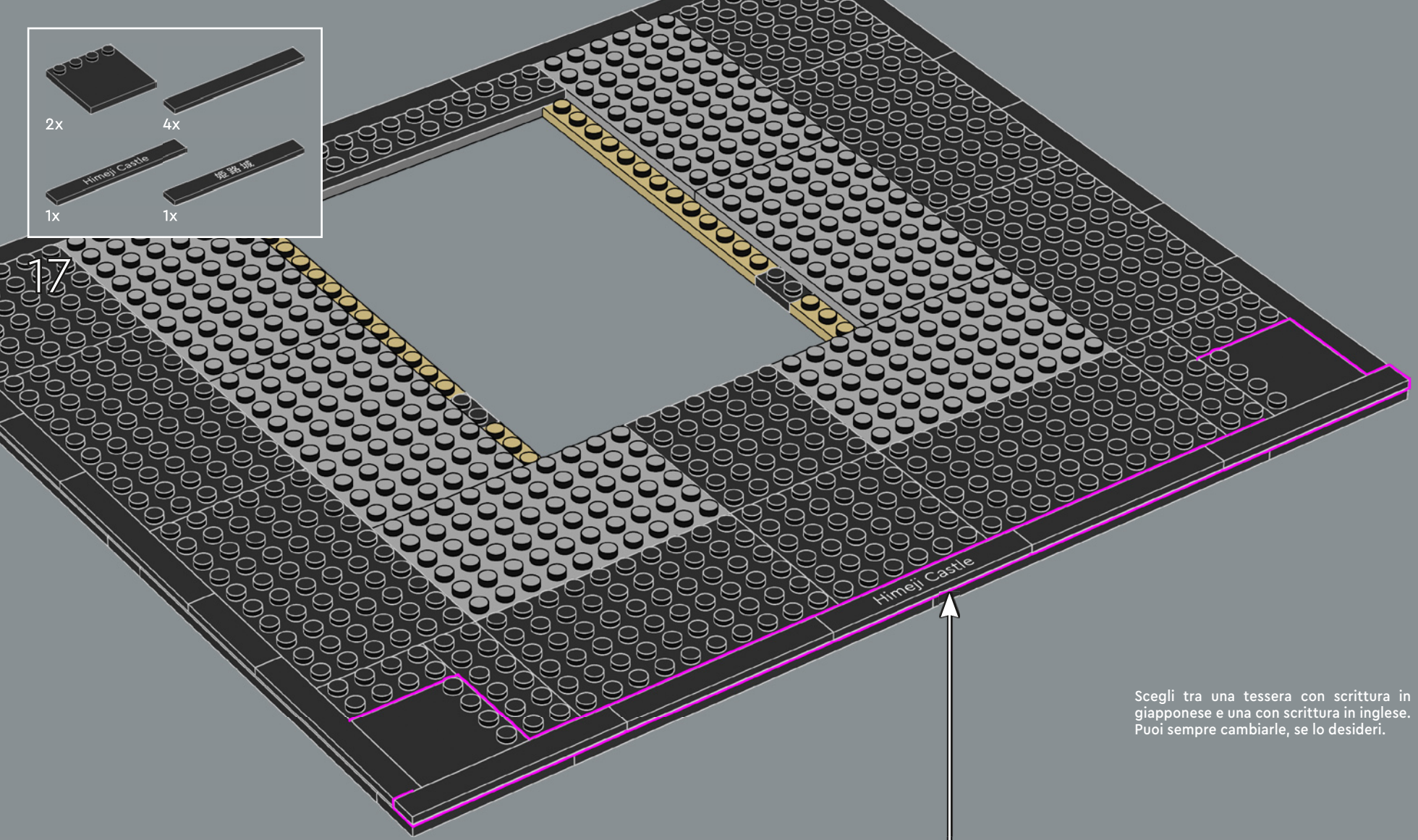

Scegli tra una tessera con scrittura in giapponese e una con scrittura in inglese. Puoi sempre cambiarle, se lo desideri.

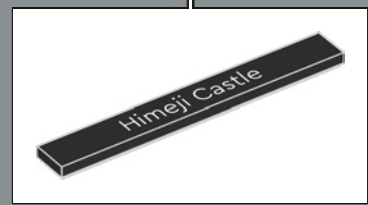

Nel 1993, il Castello di Himeji è stato inserito nell'elenco dei Patrimoni dell'Umanità dell'UNESCO, conferendo al monumento lo status di vero capolavoro e culmine dell'architettura dei castelli giapponesi in legno.

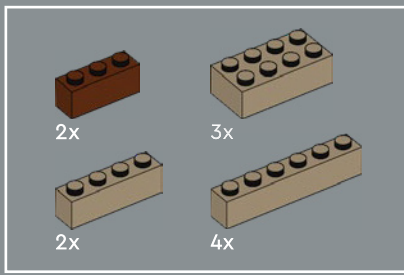

18

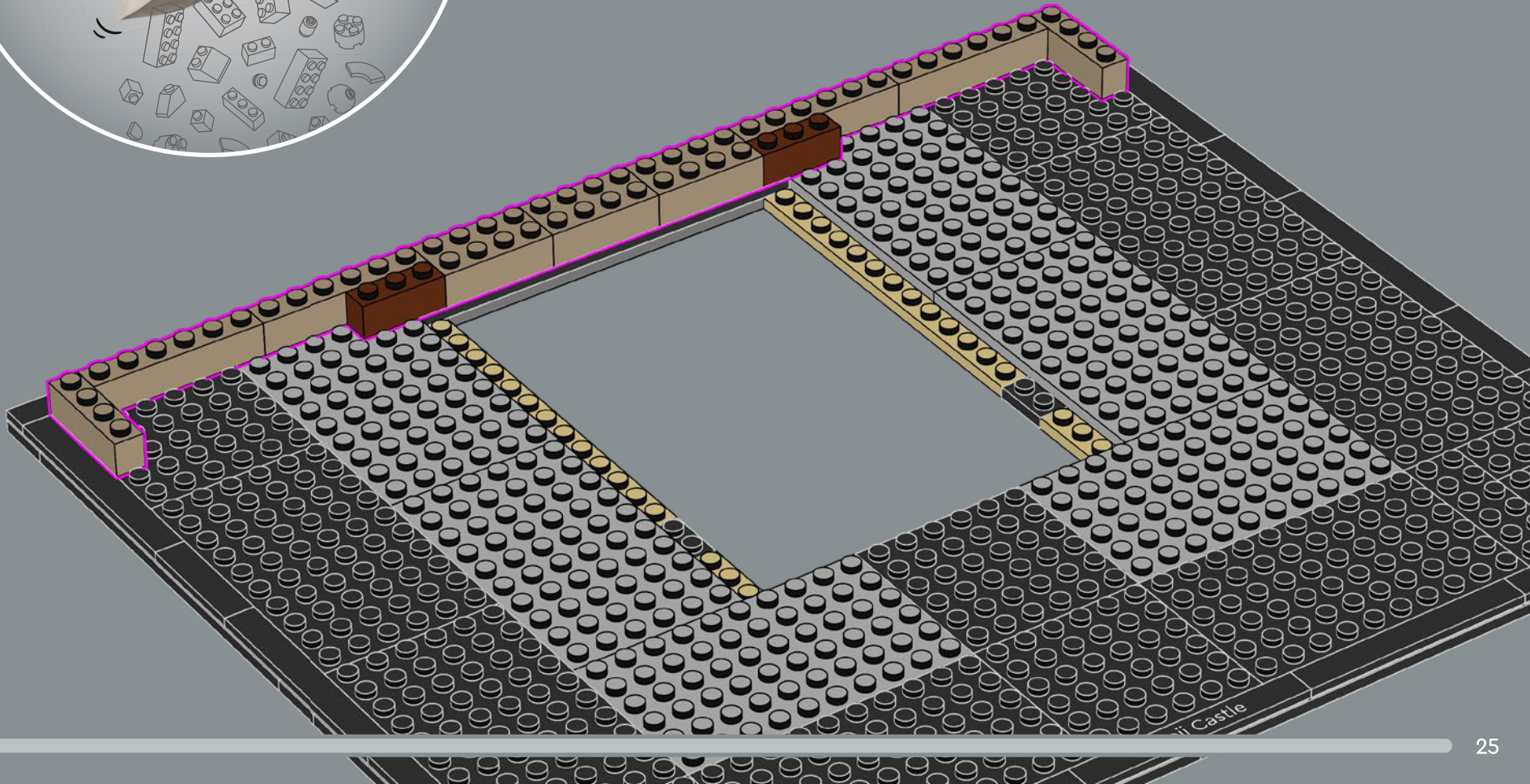

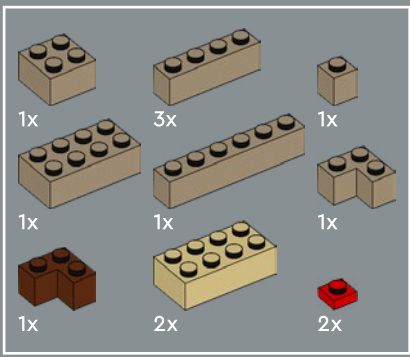

19

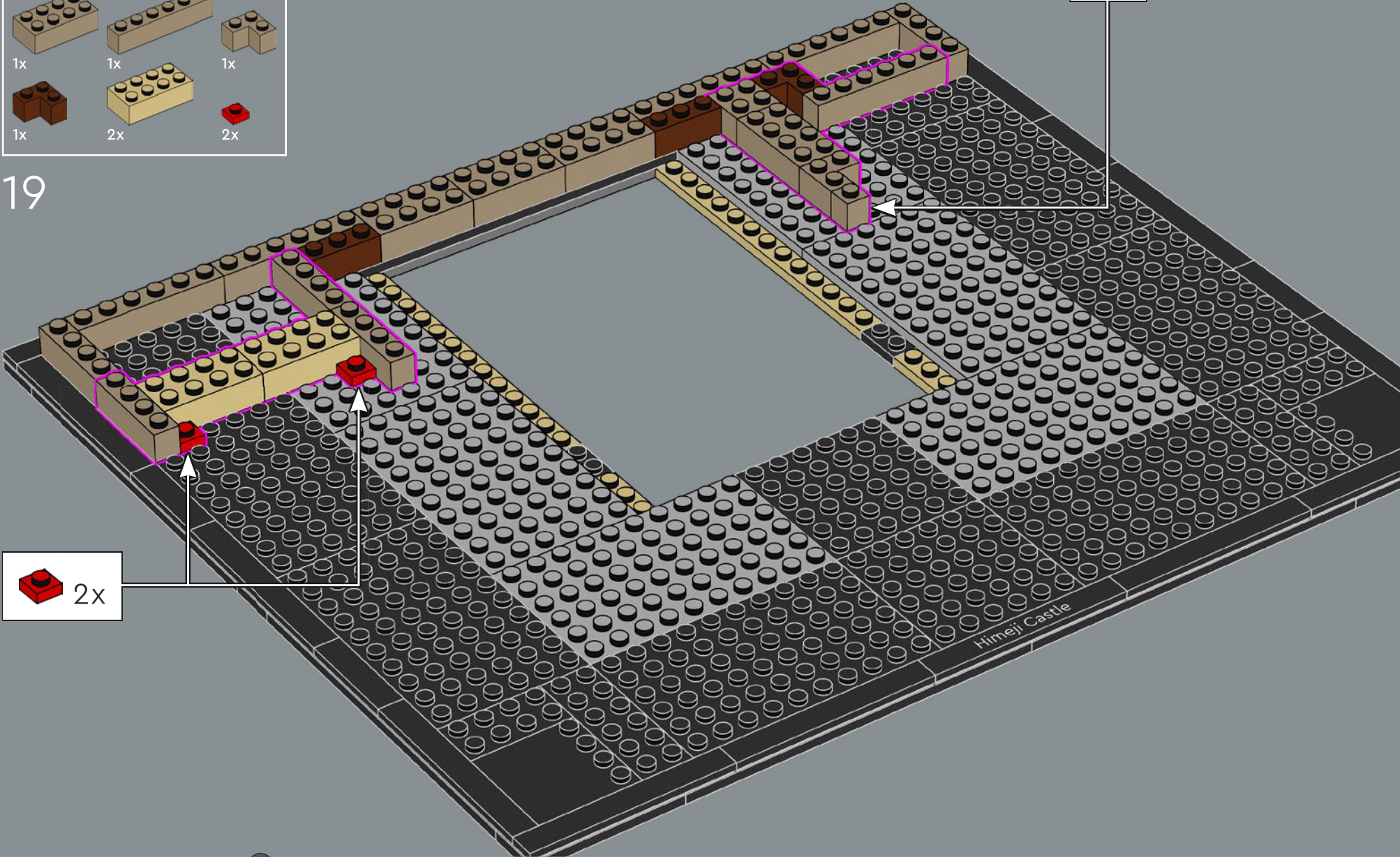

Himeji Castle

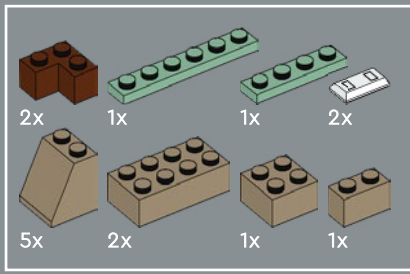

20

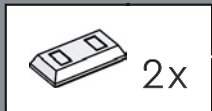
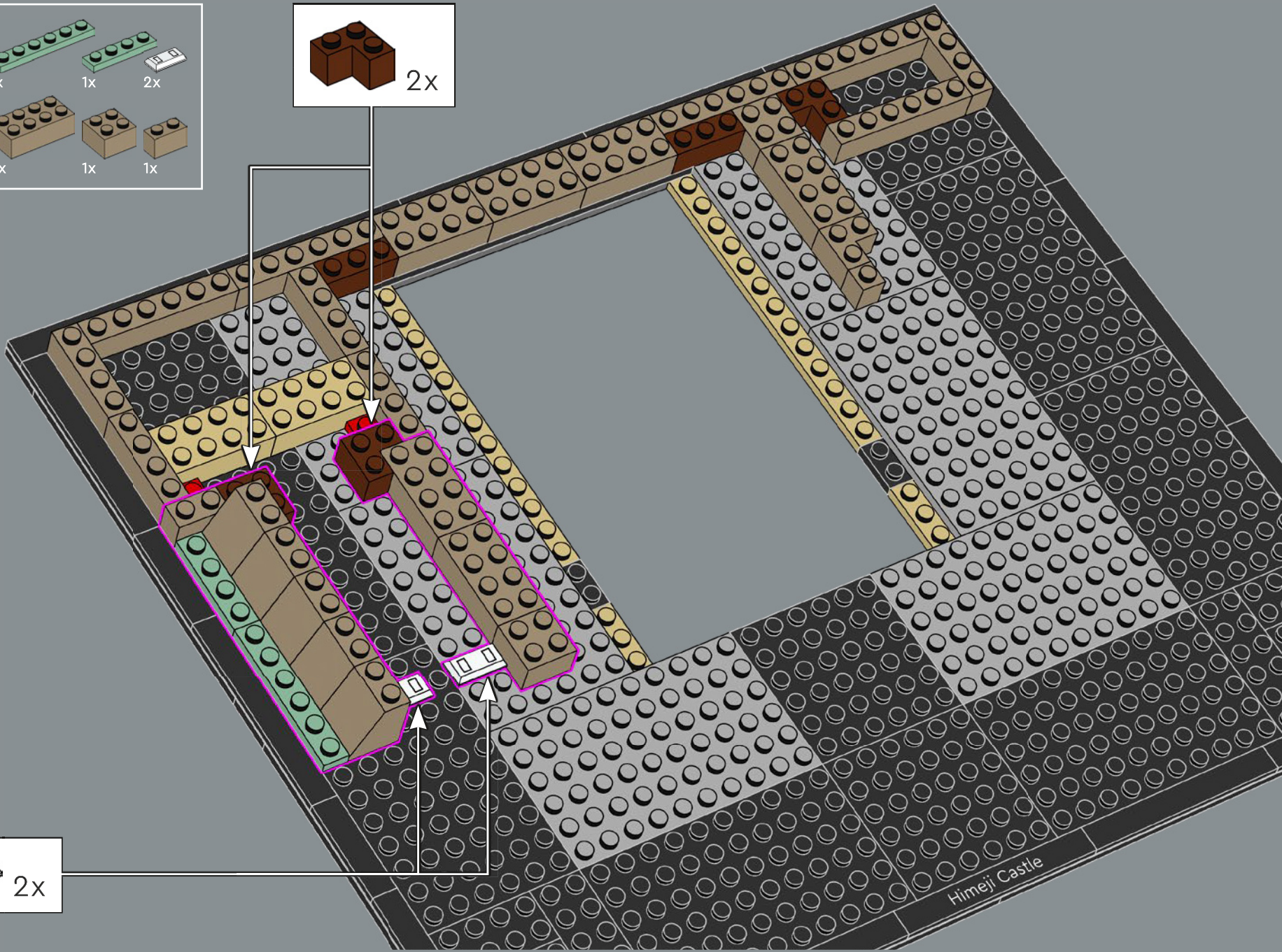

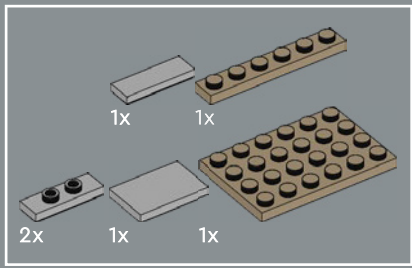



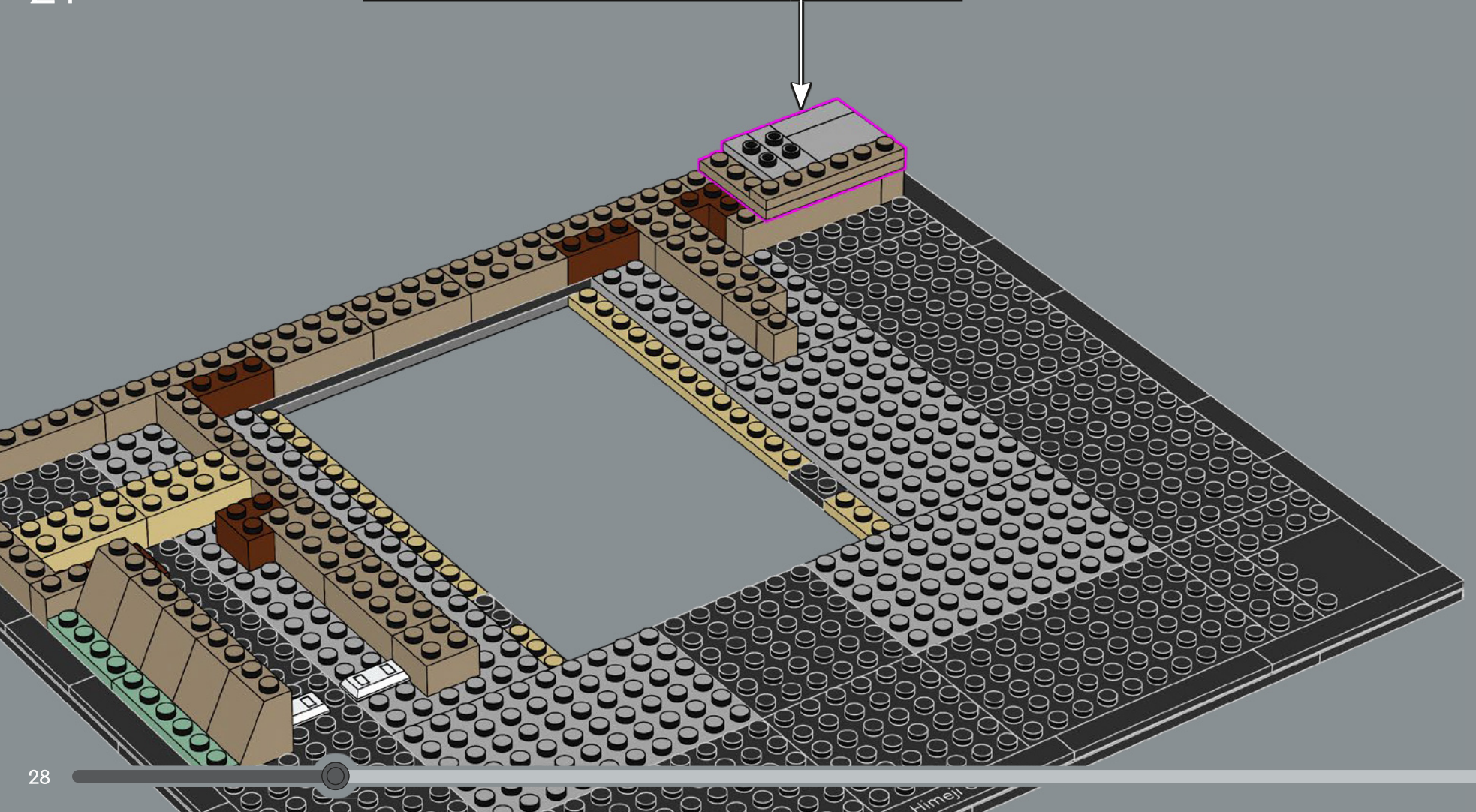
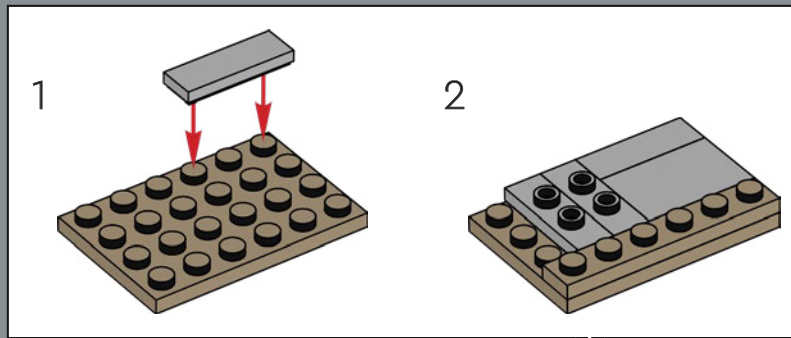

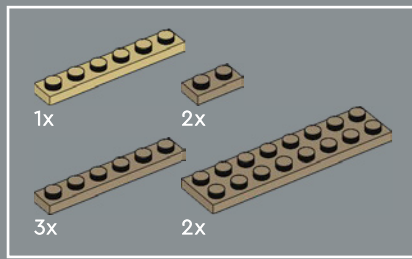

21

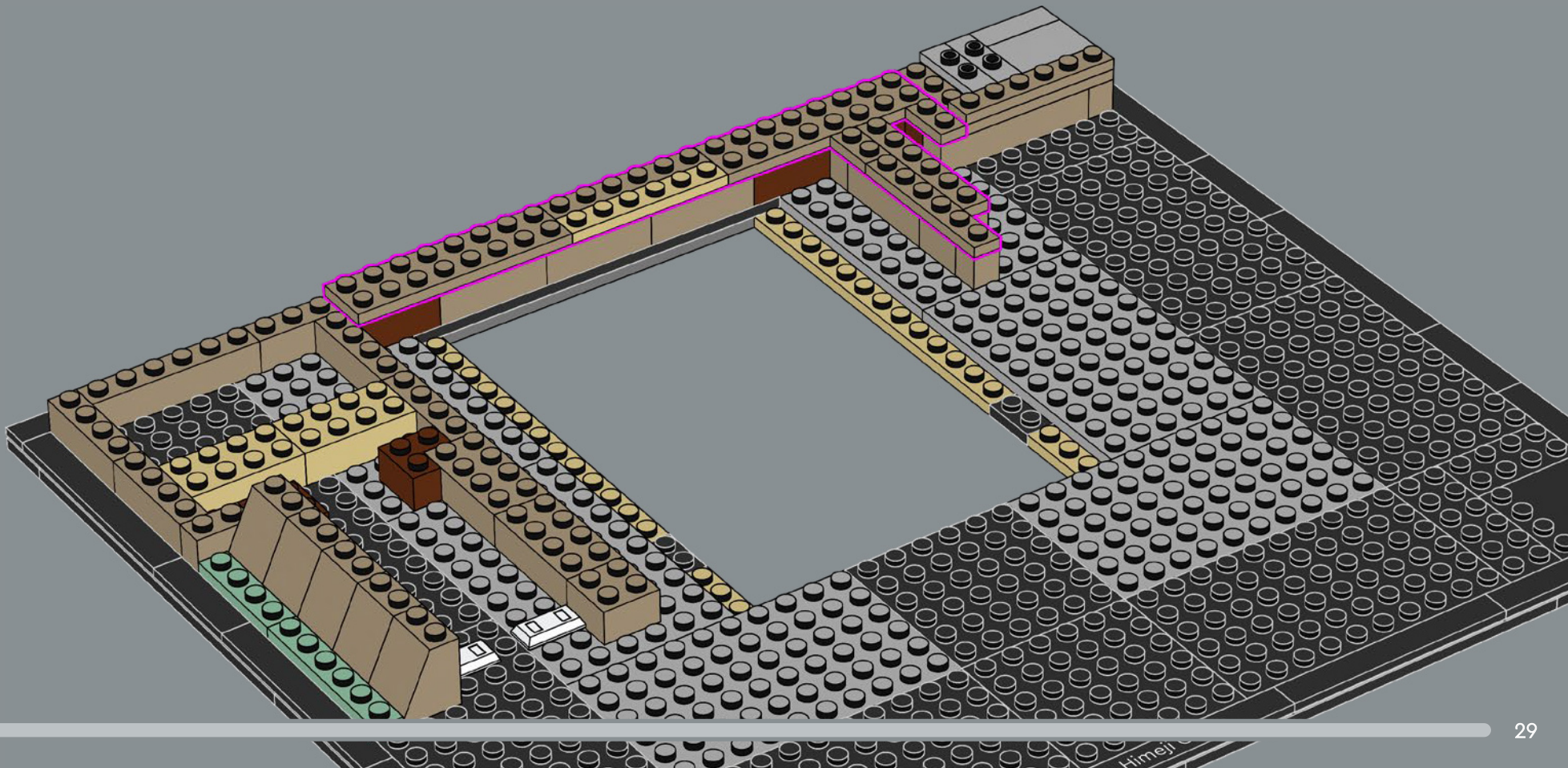



22



- 1x 
- 1x 
- 2x 
- 2x 
- 1x 

23

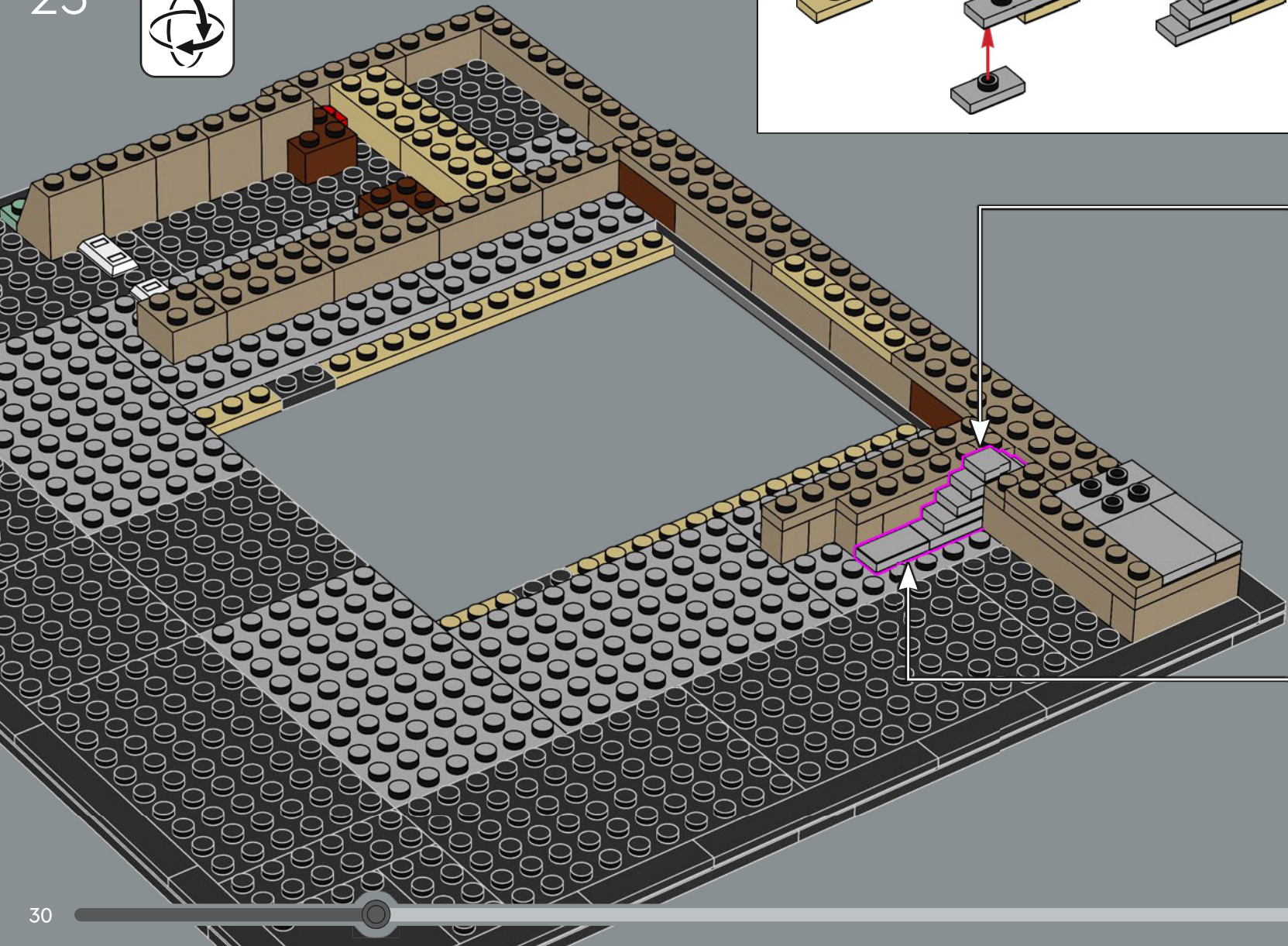
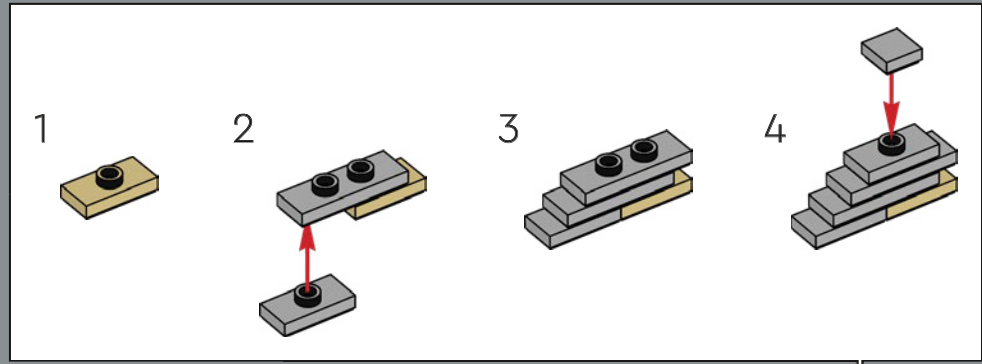

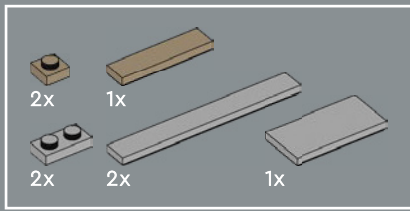

24

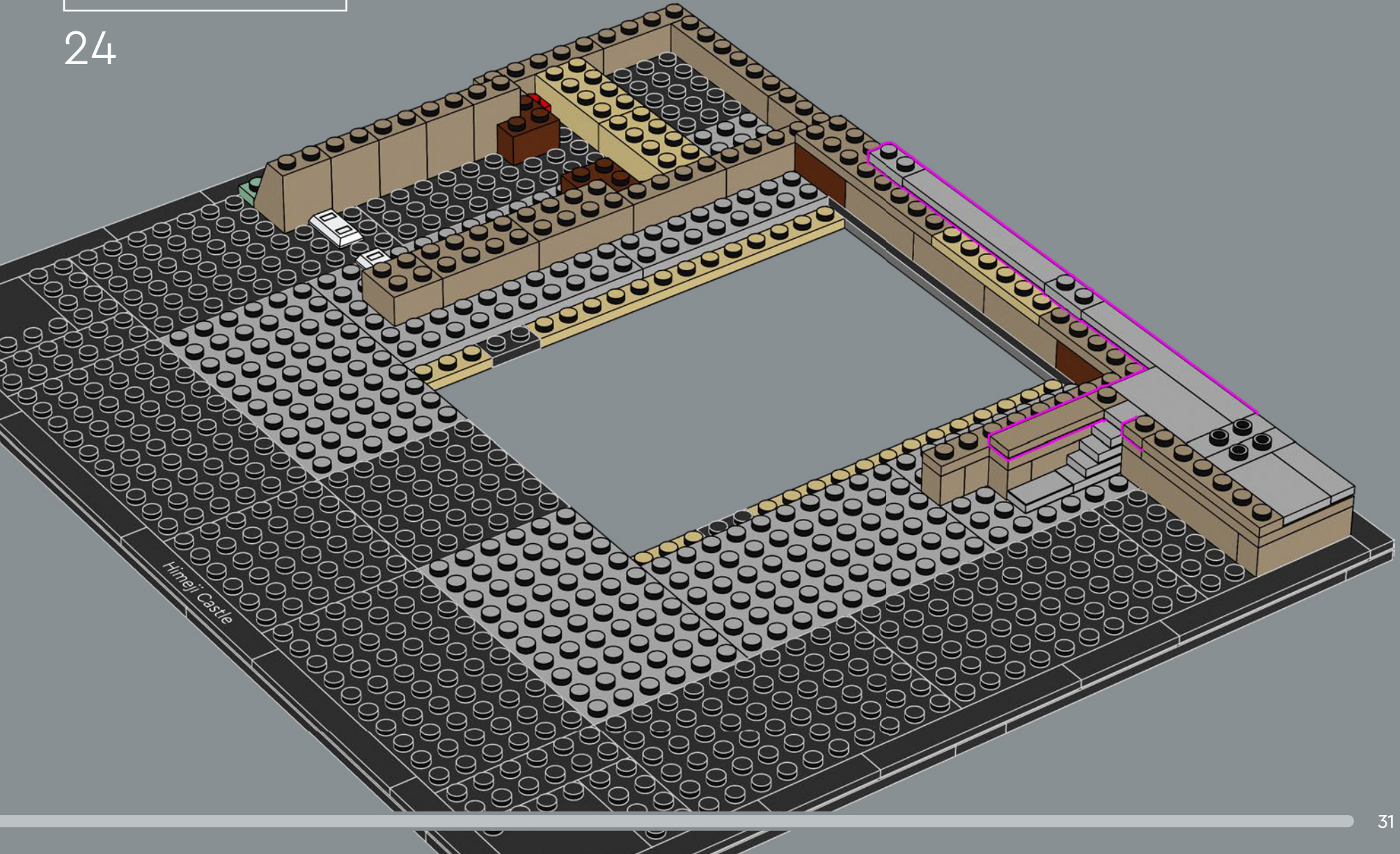

1x  4x  1x 

25

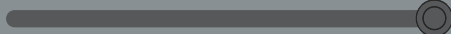
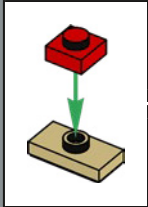
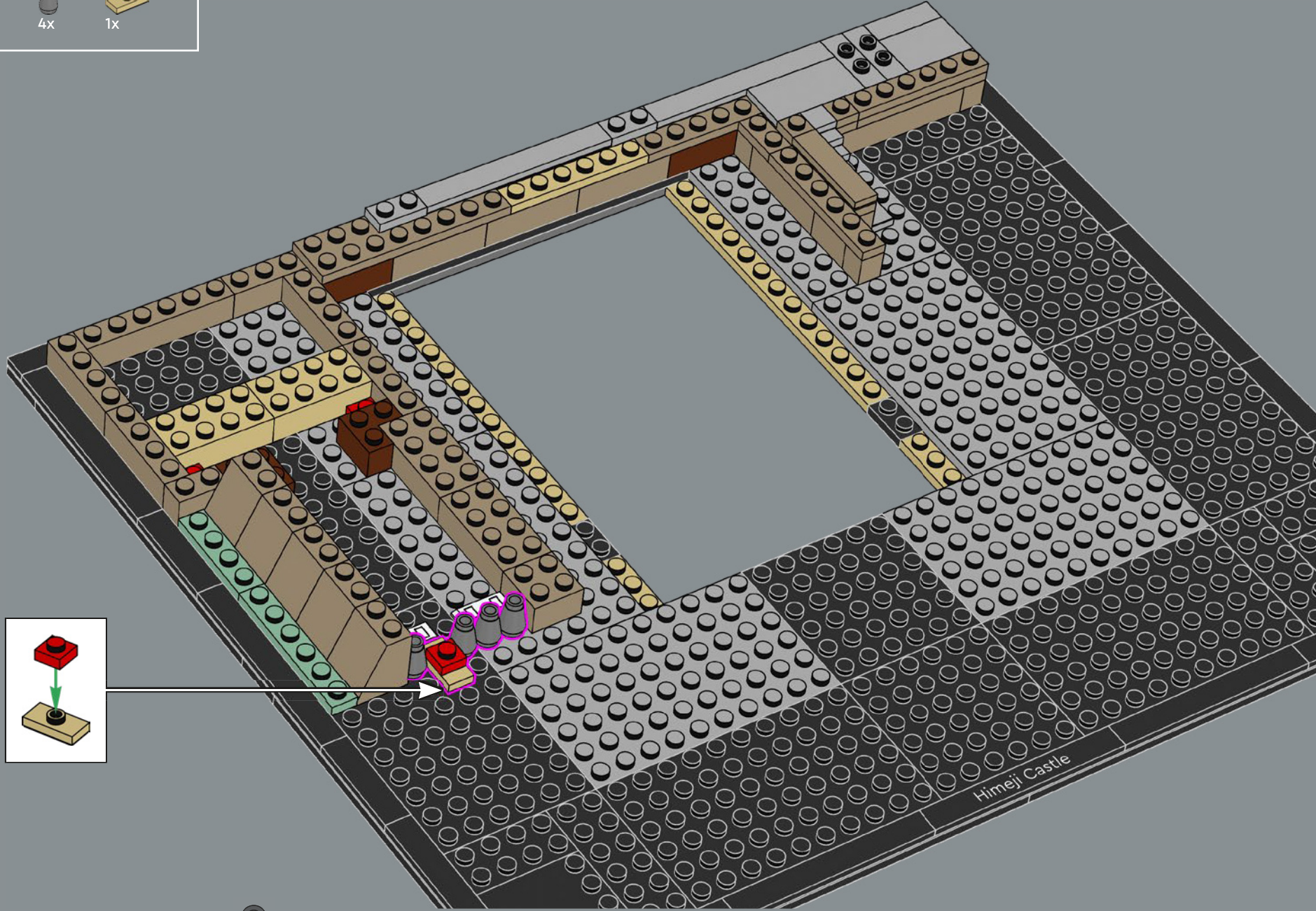

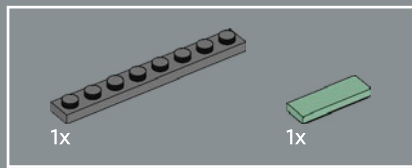

26

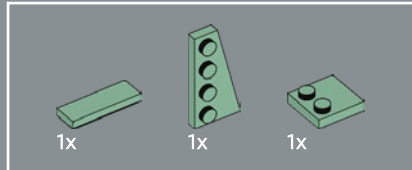
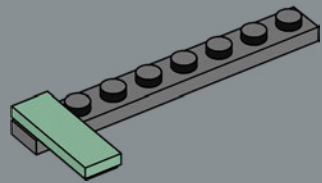

27

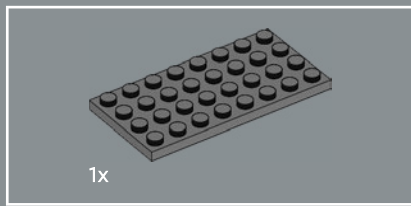
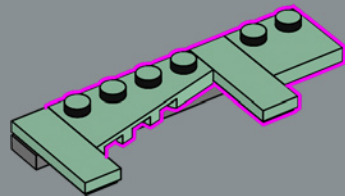

28

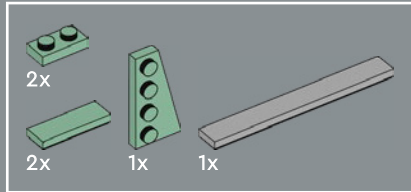
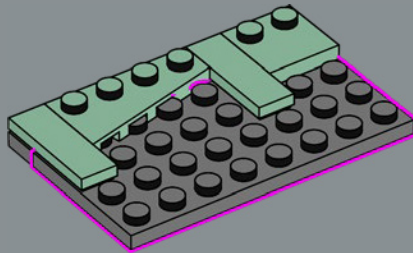

29

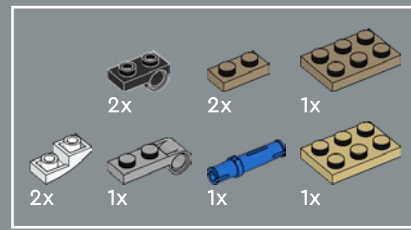
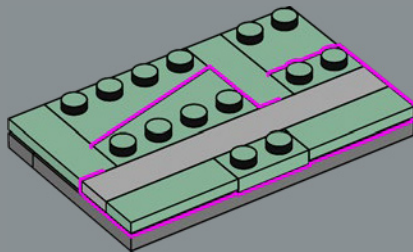

30

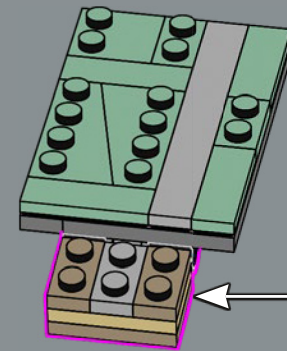
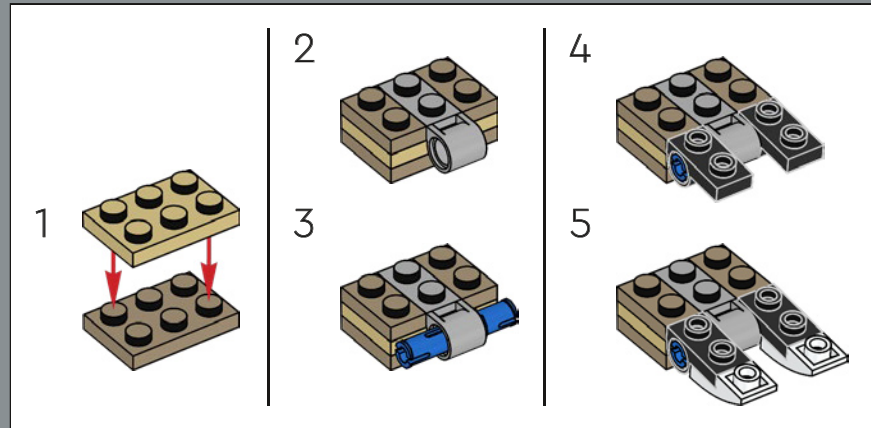

31

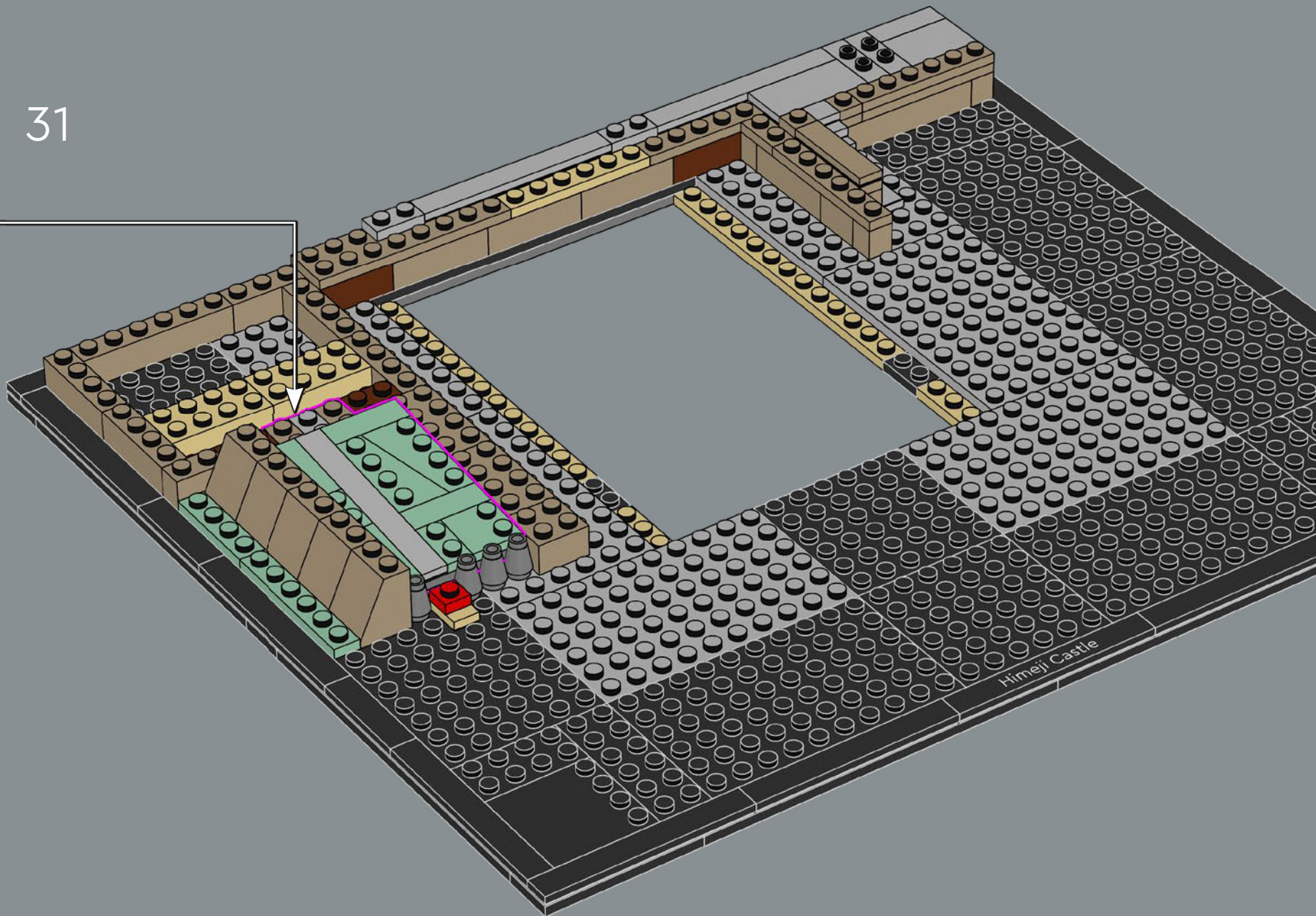

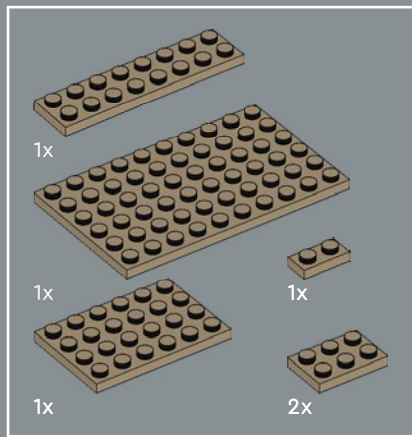

32

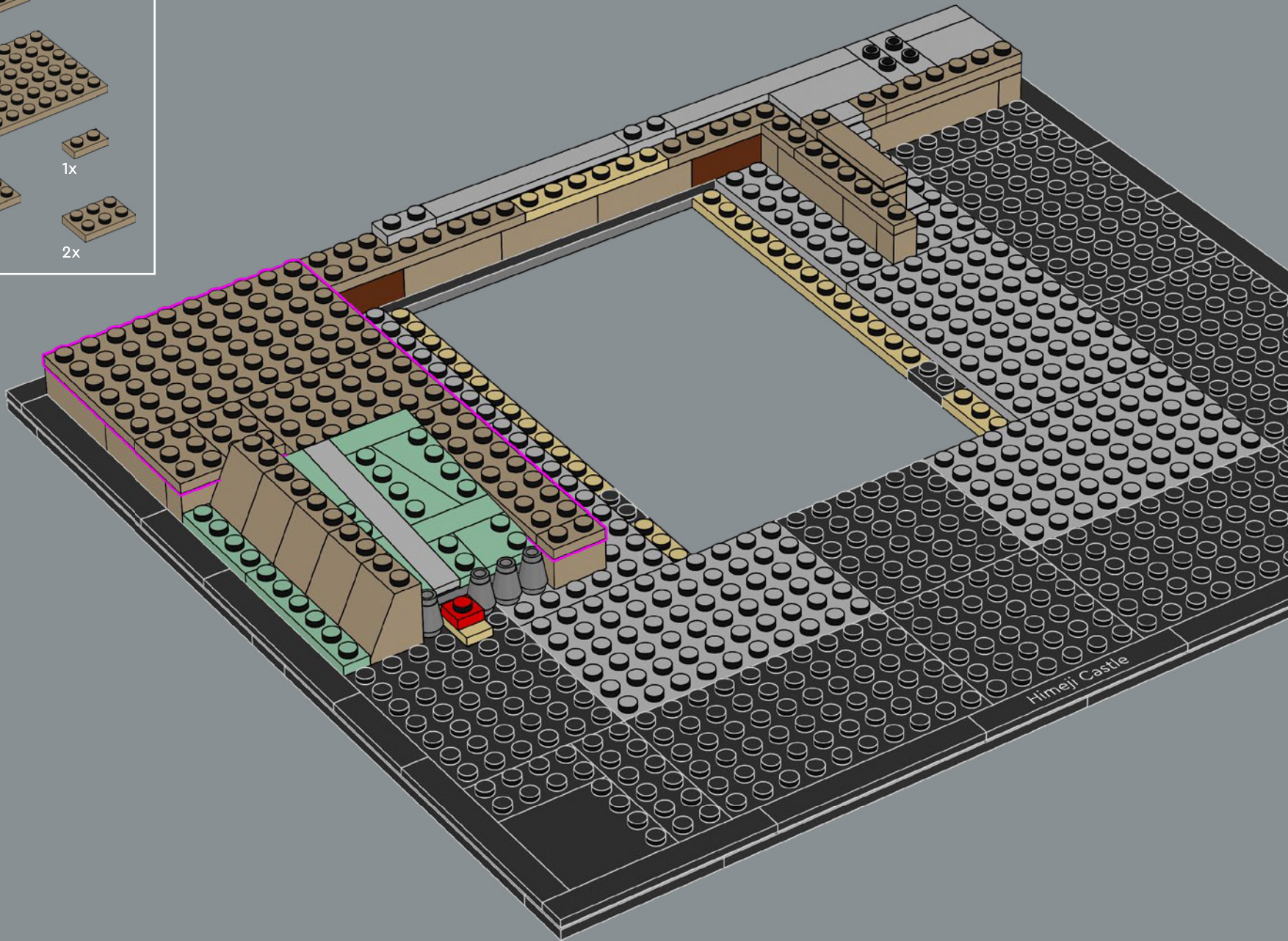

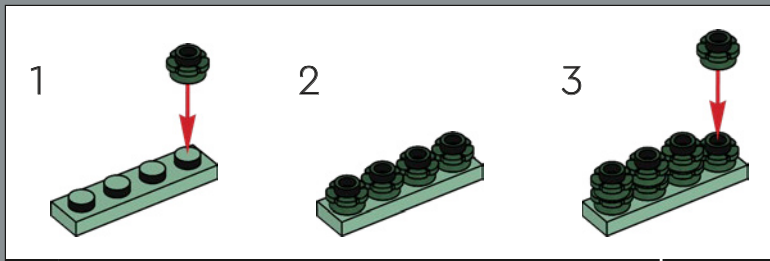
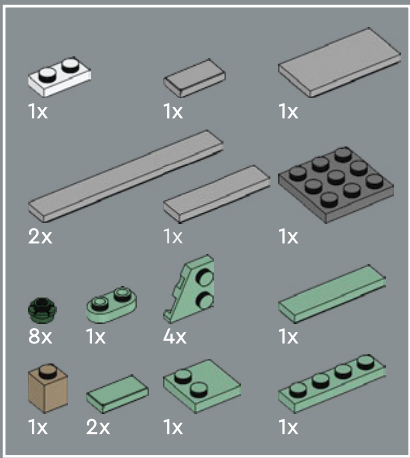

33

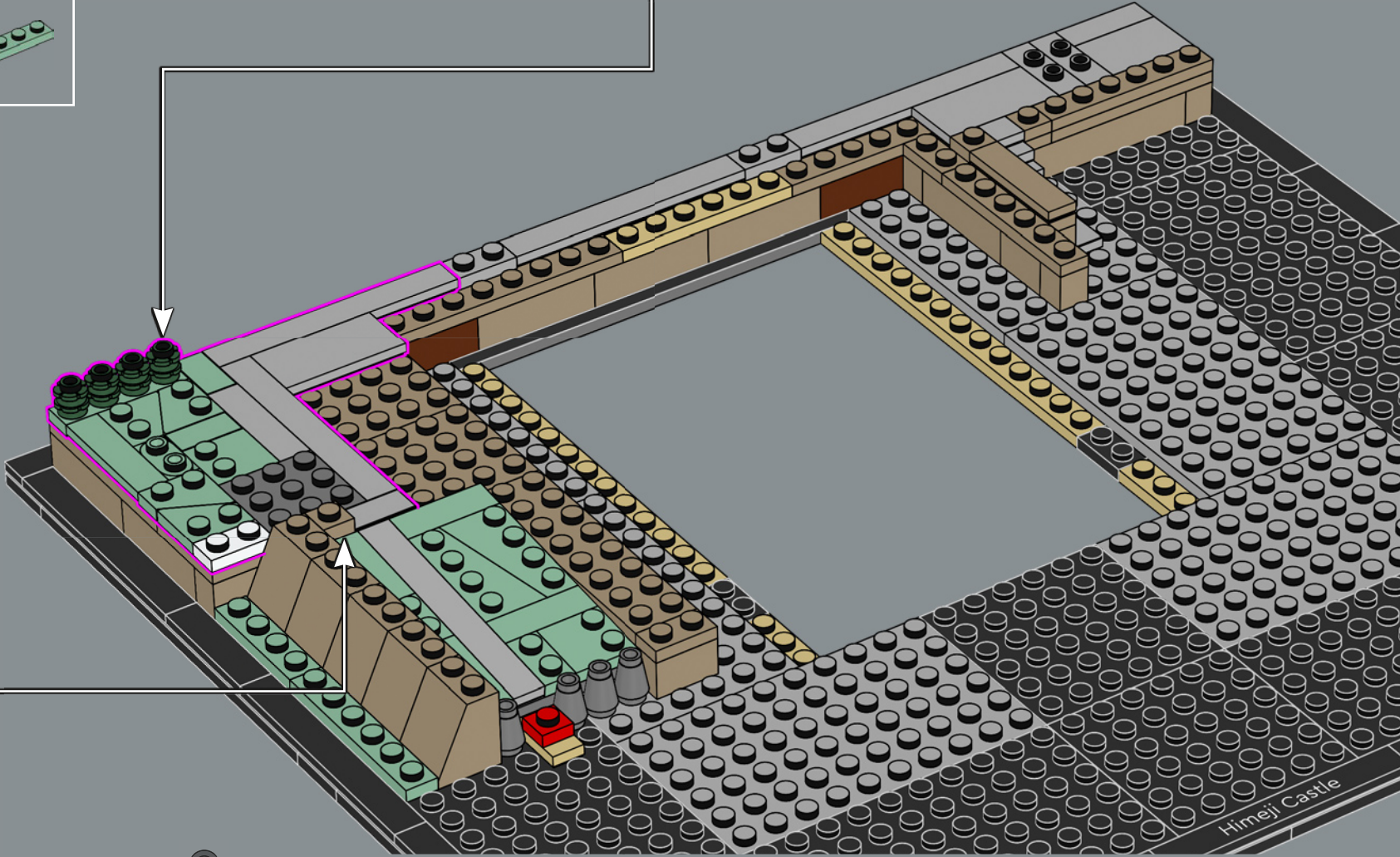

Himeiji Castle

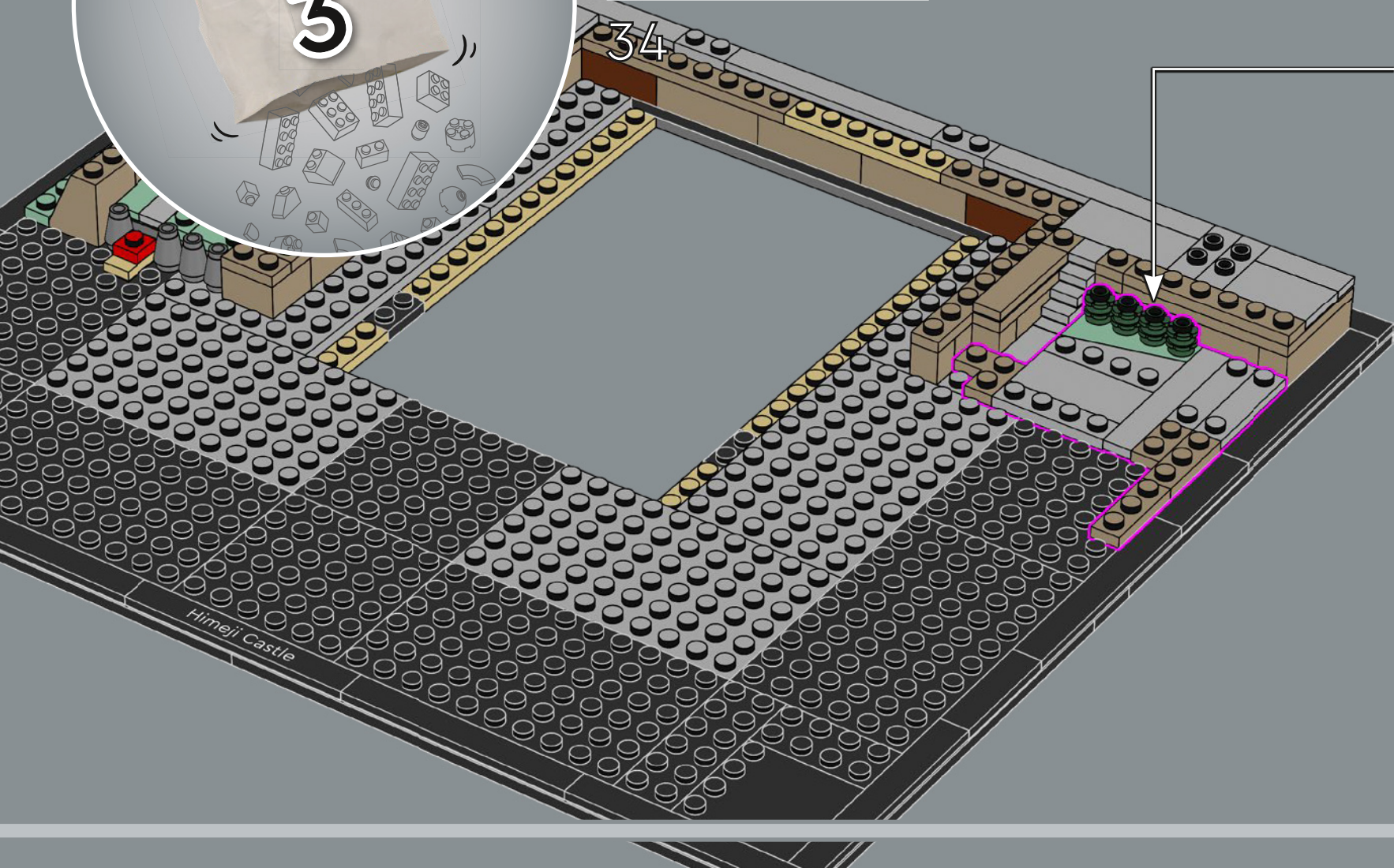
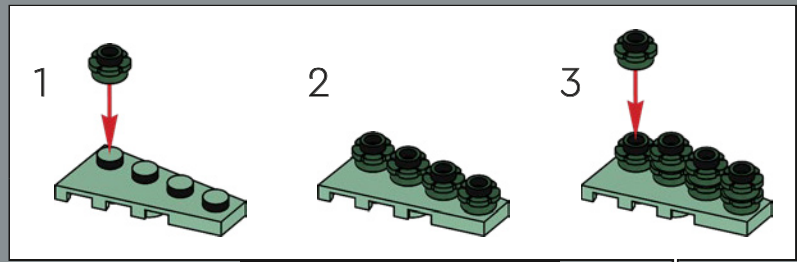
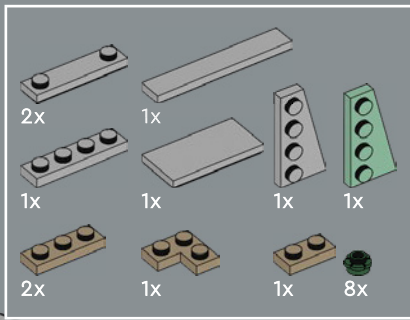

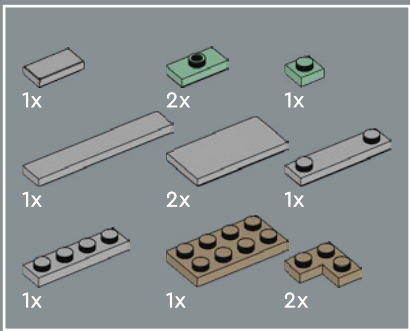

35

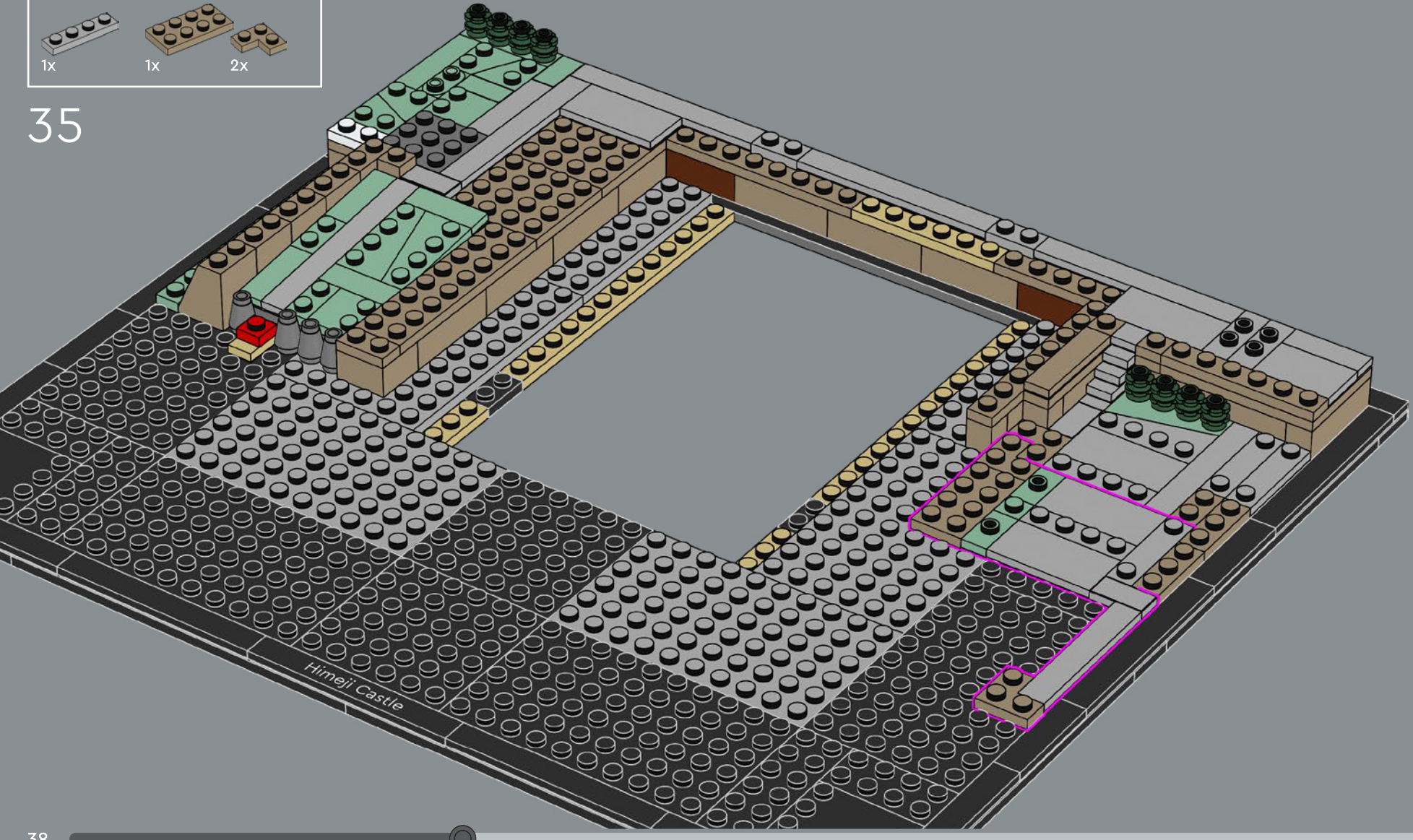

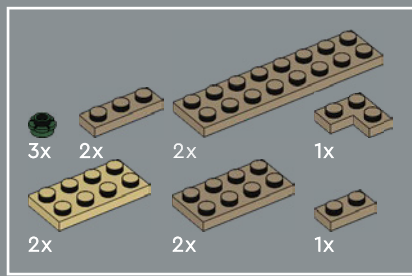

36

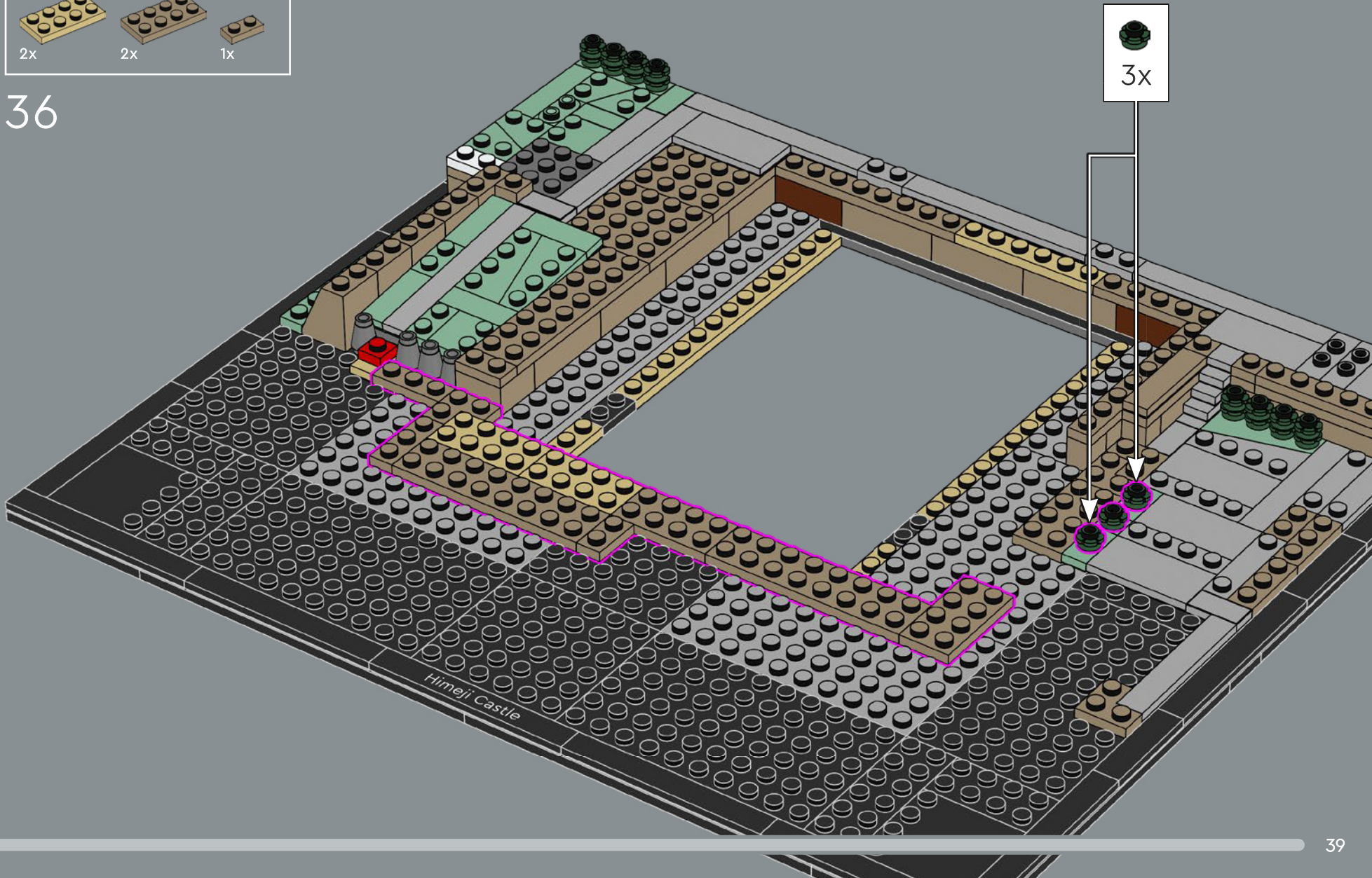

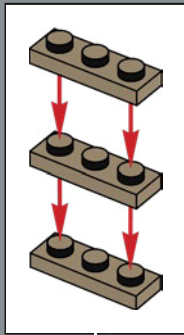
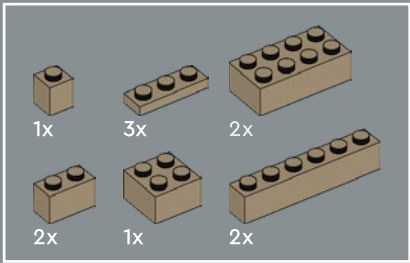

37

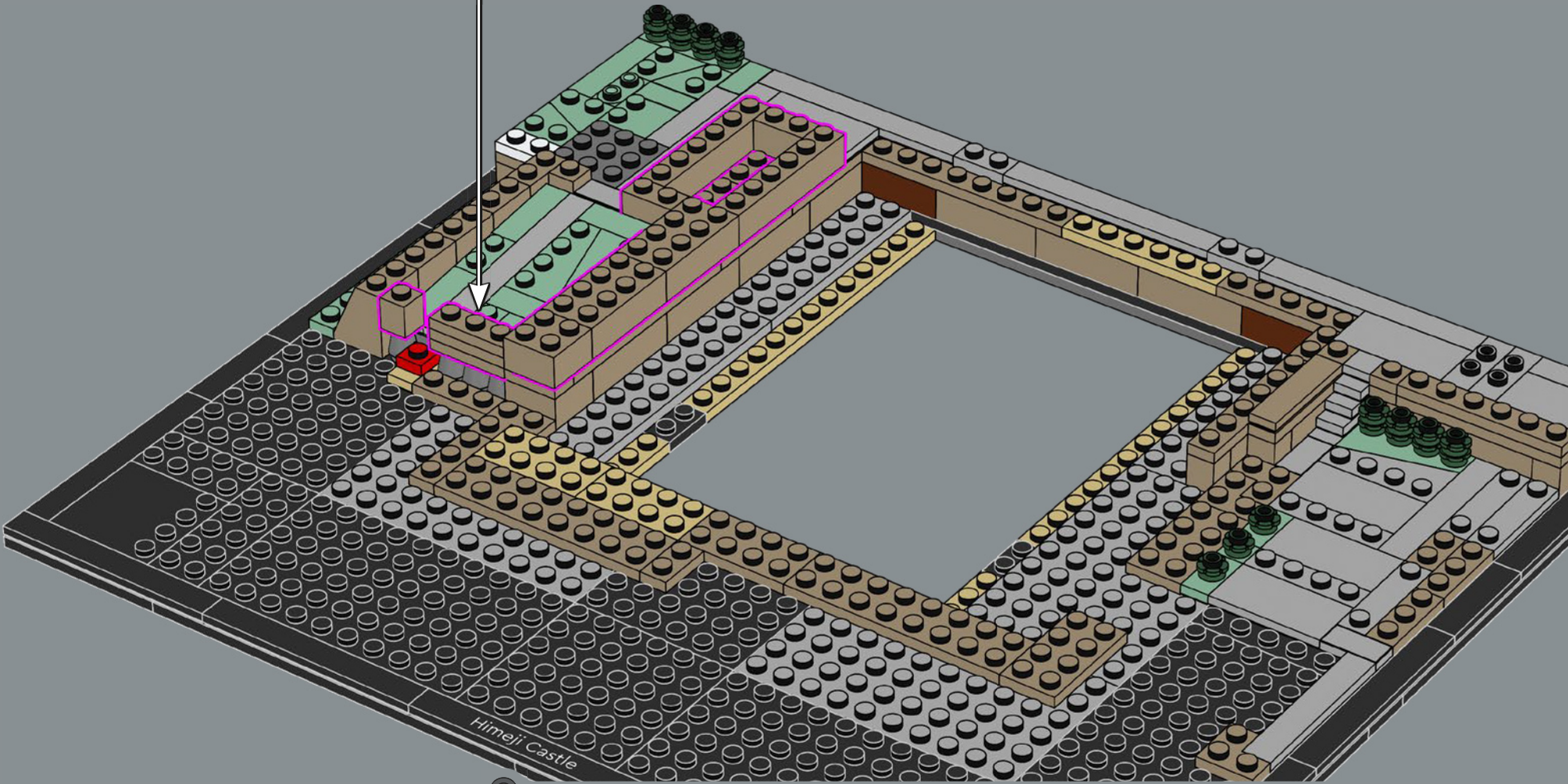

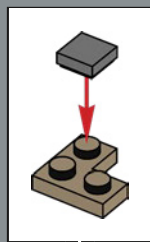
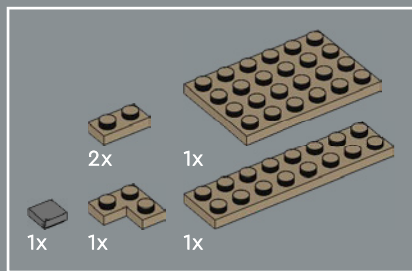

38

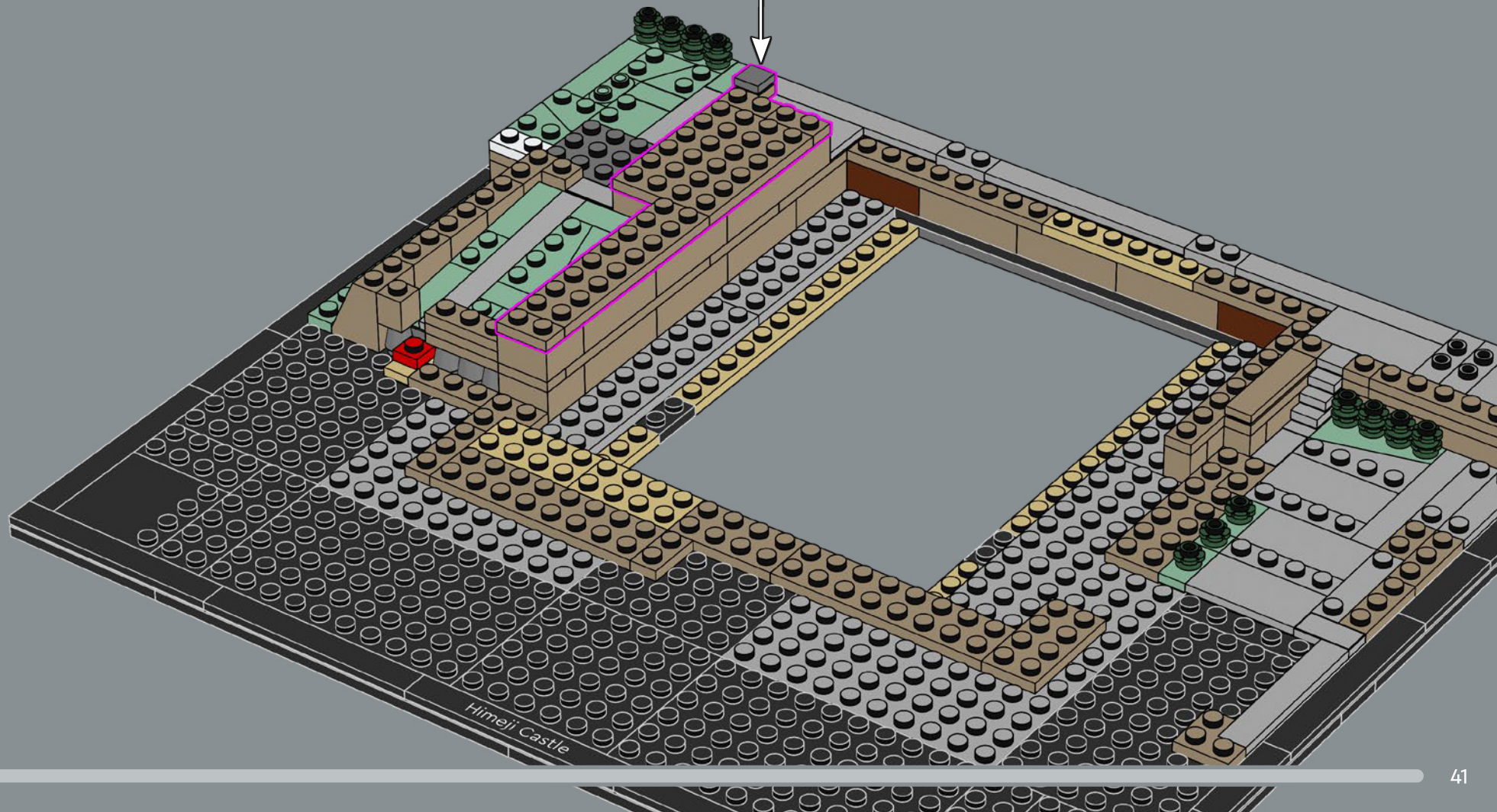

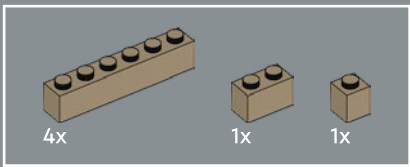

39

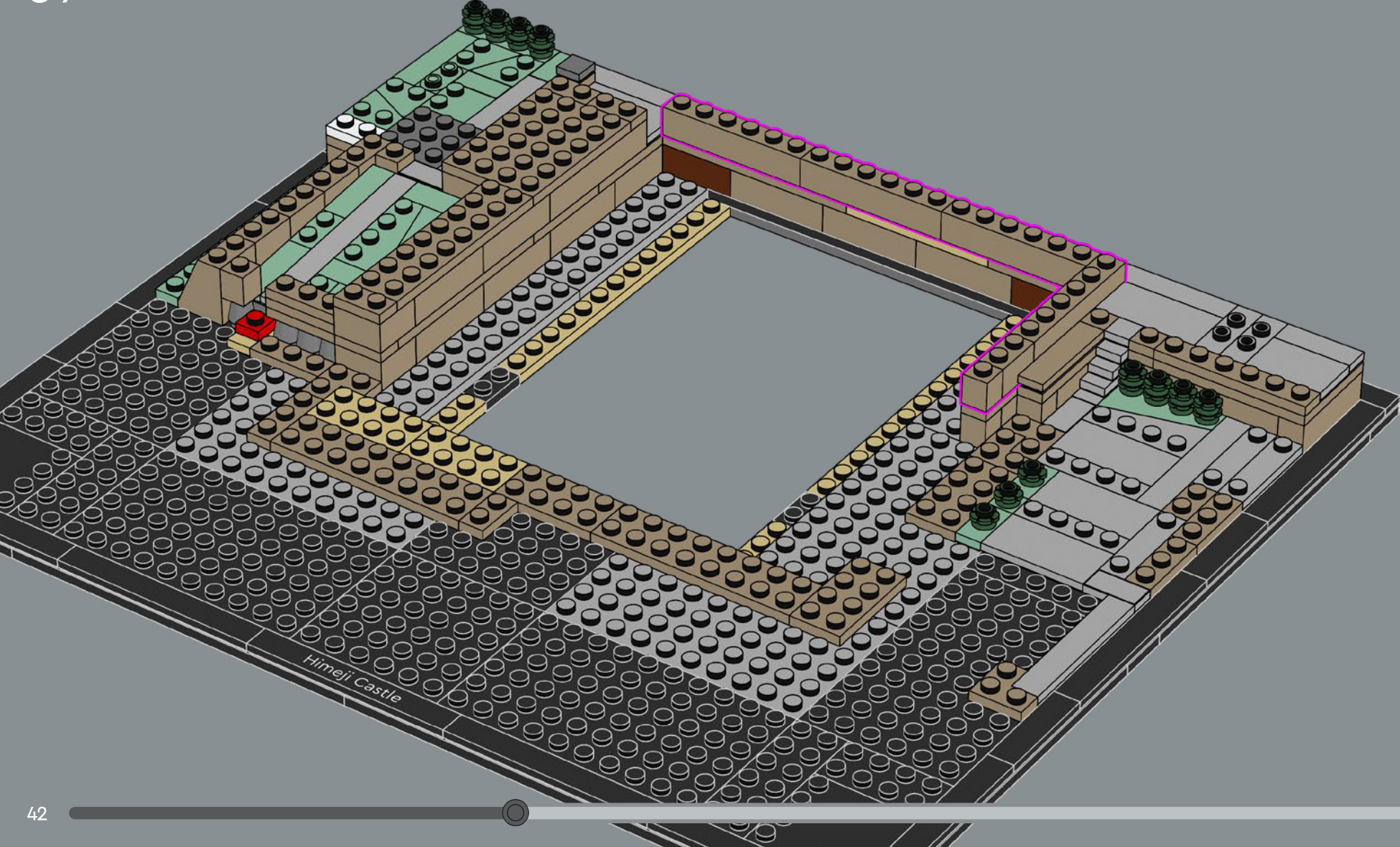

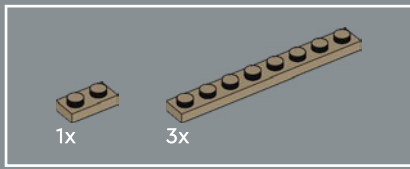

40

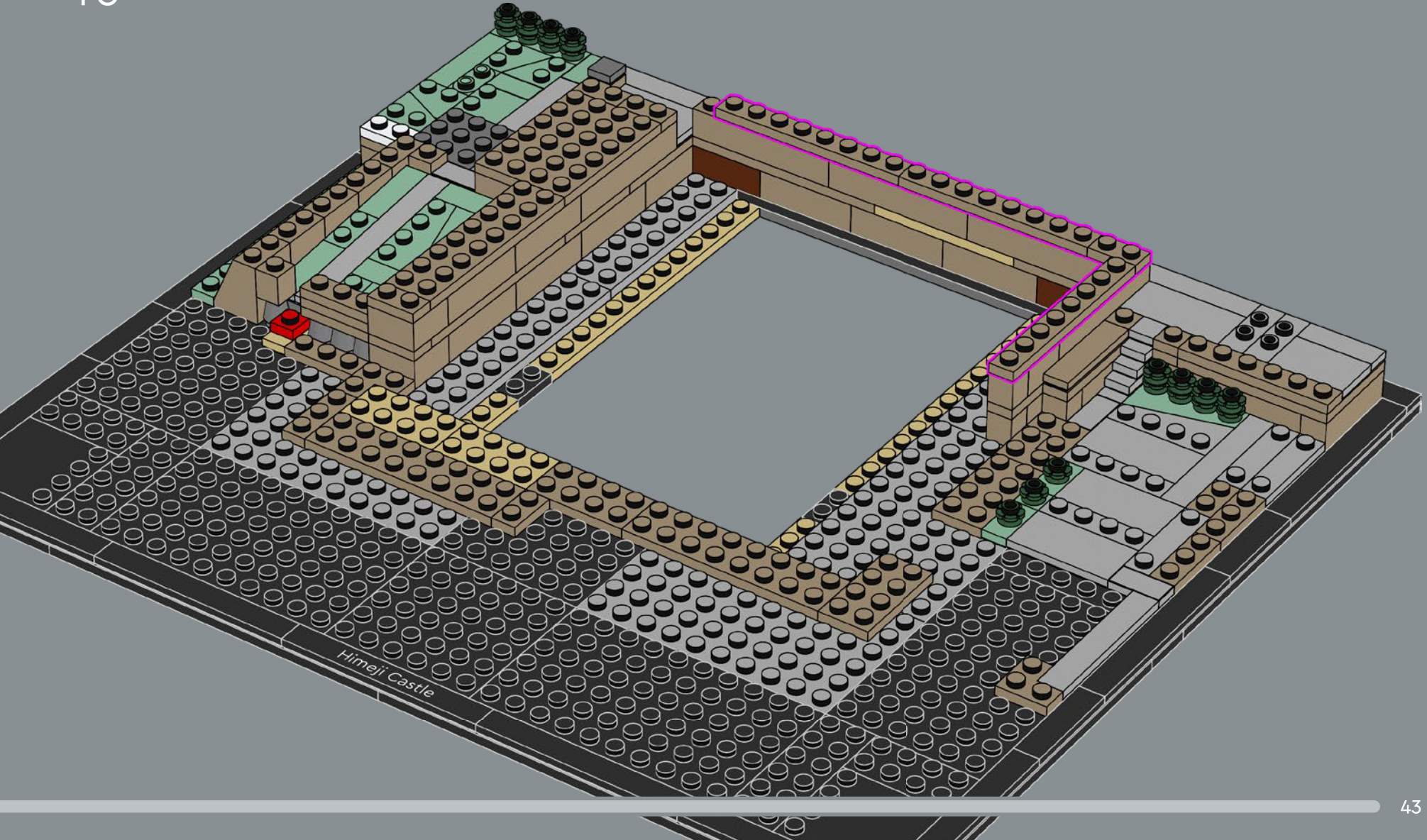

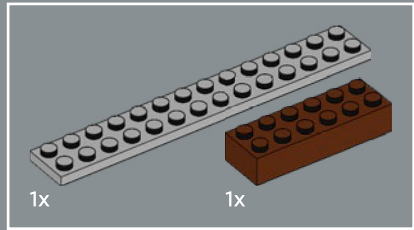
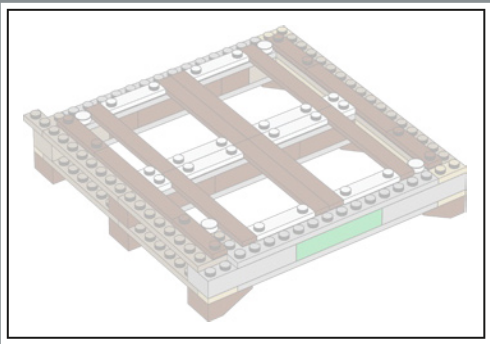

41

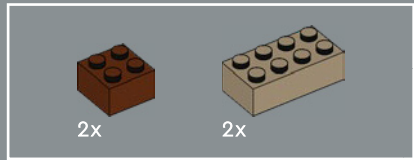
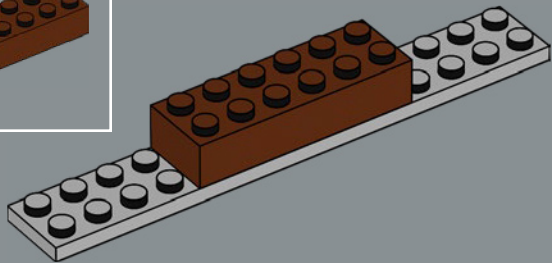

42

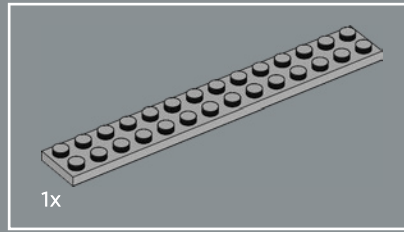
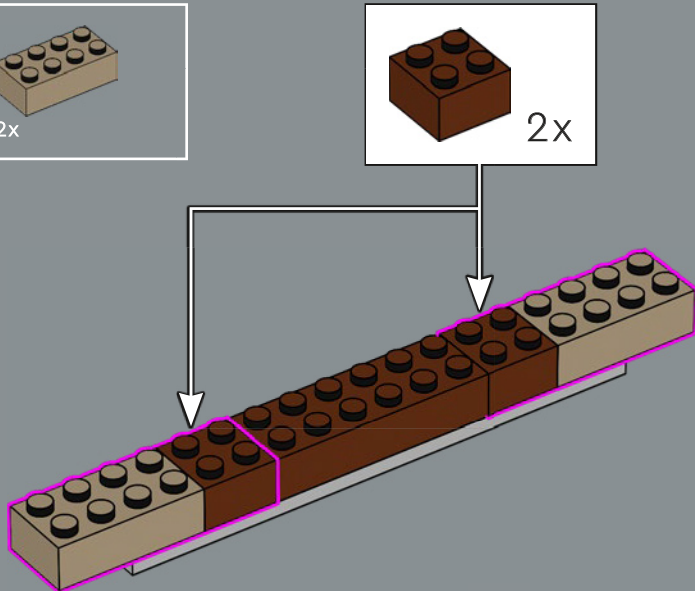

43

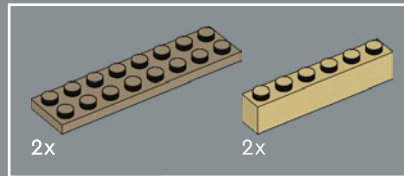
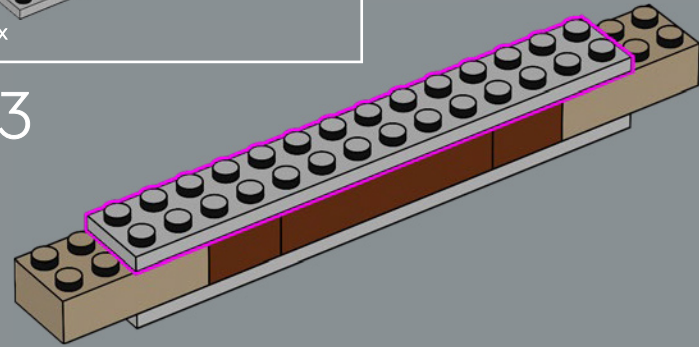

44

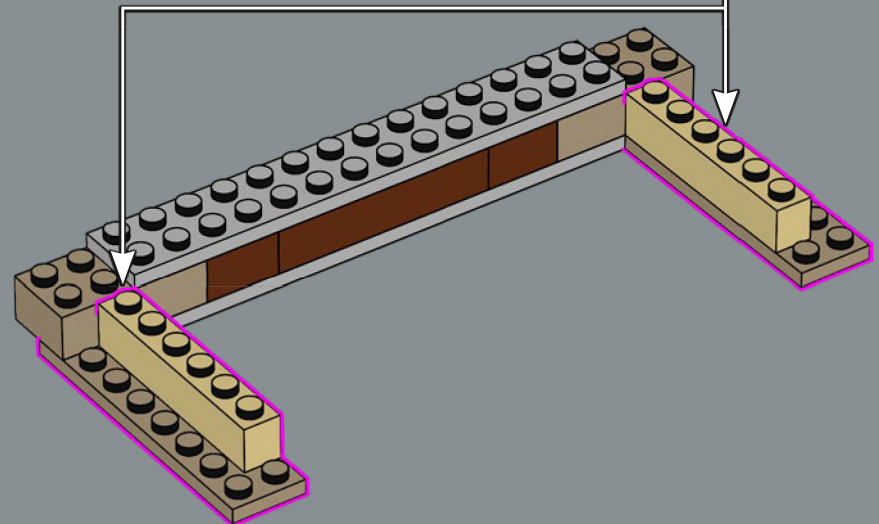
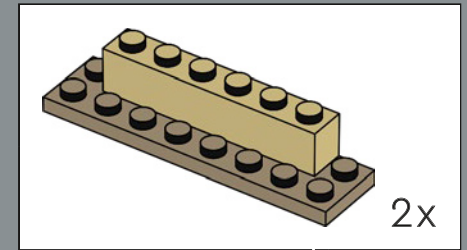

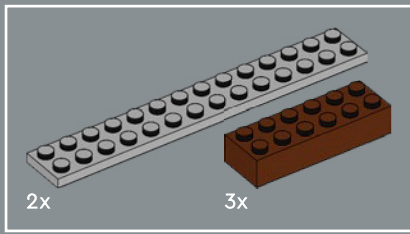

45

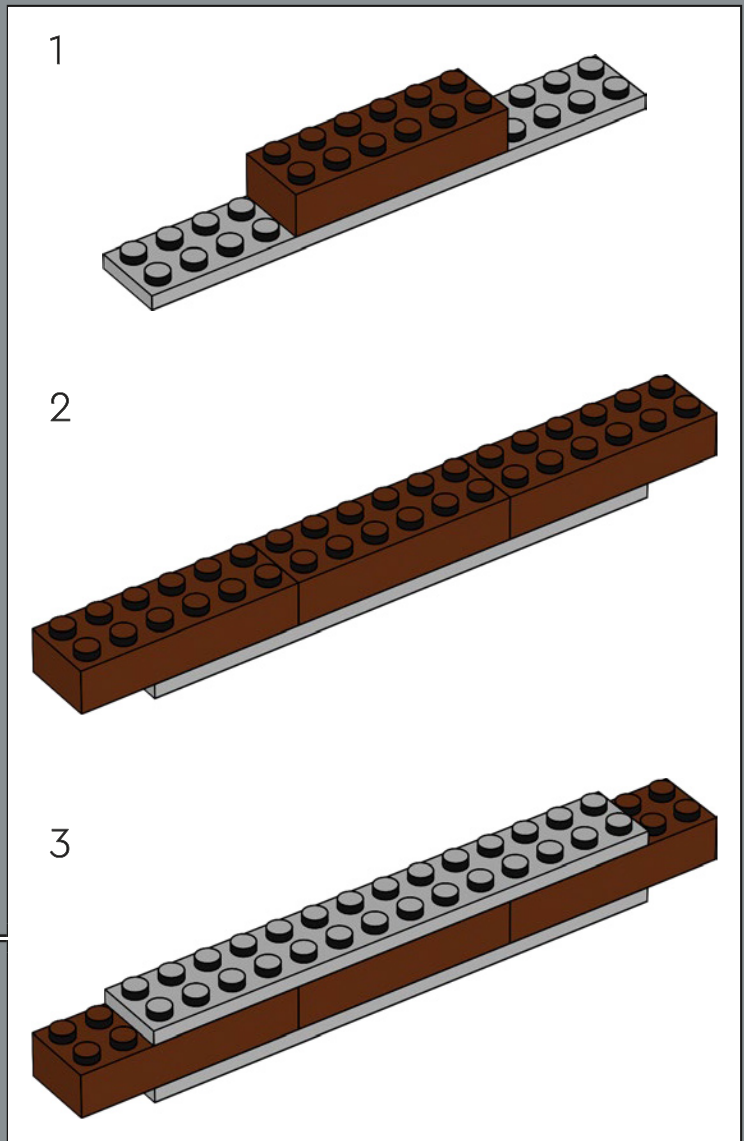
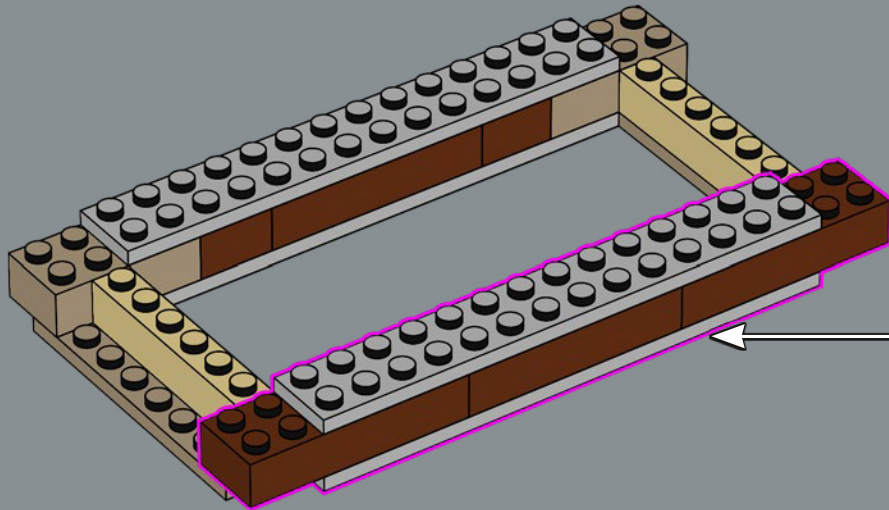

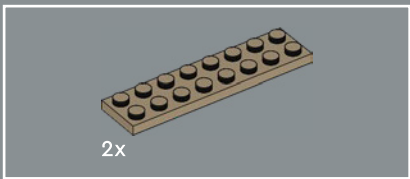

46

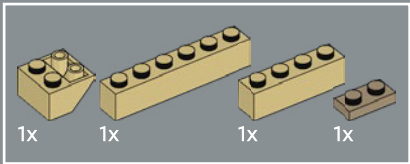
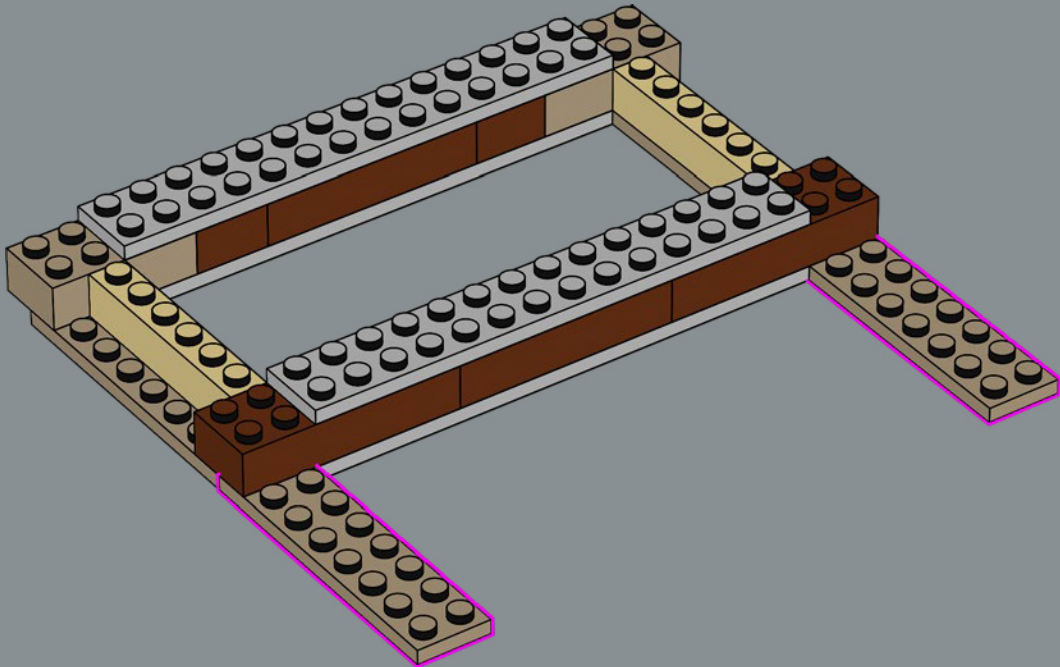

47

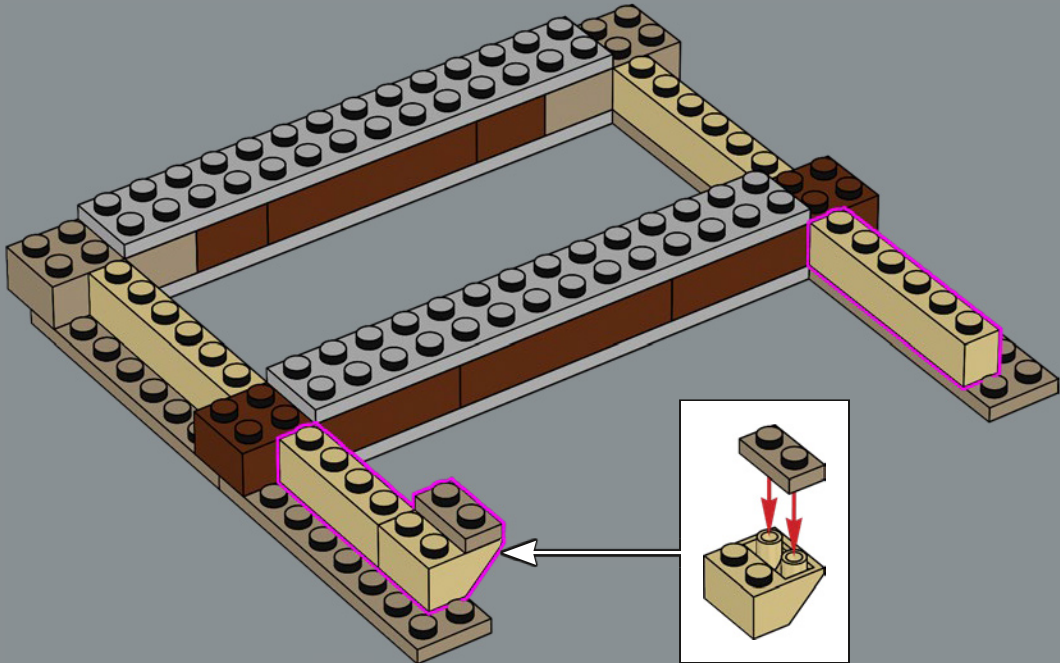

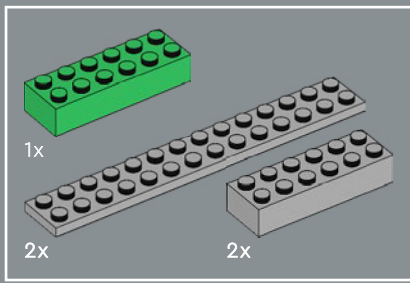

48

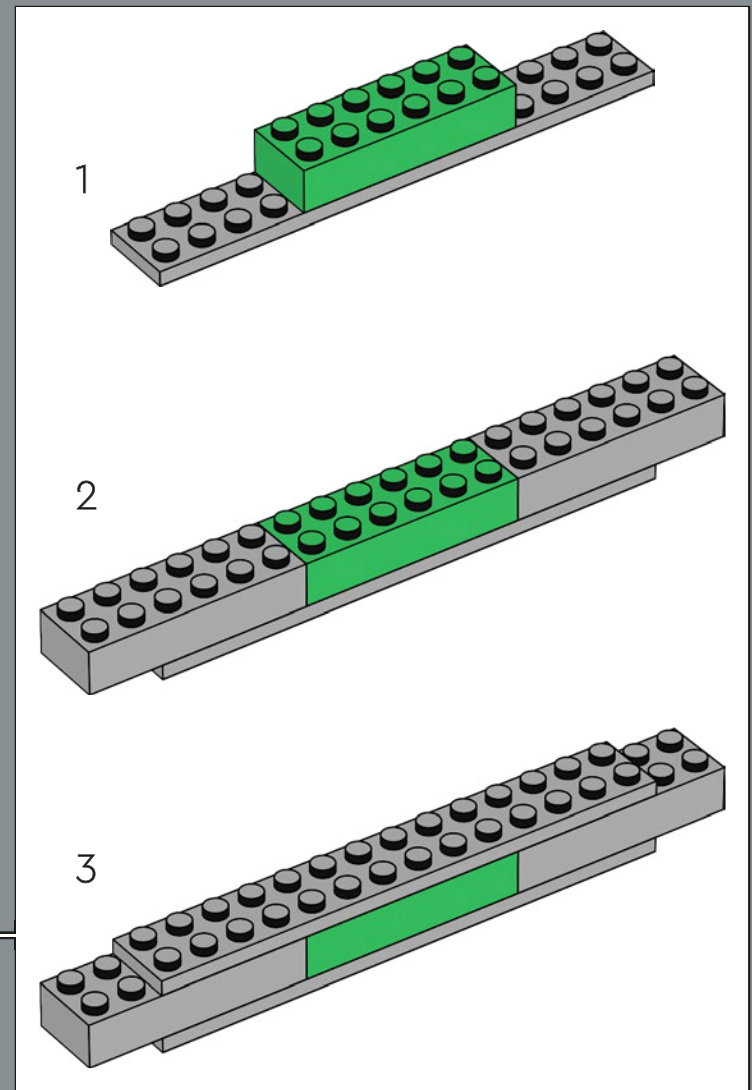
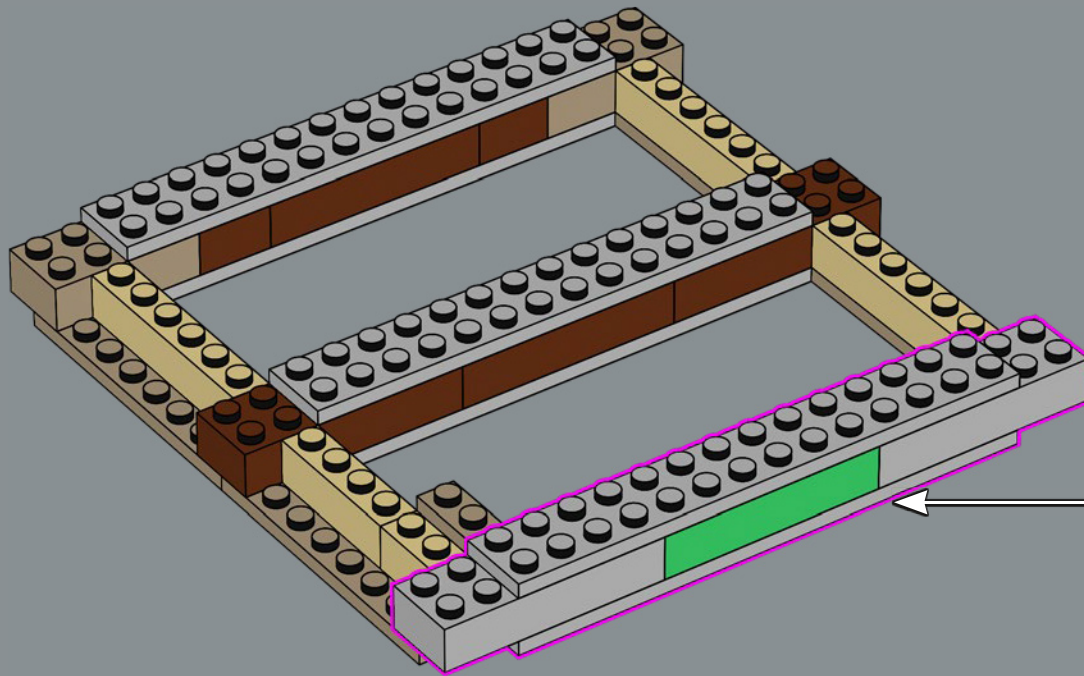

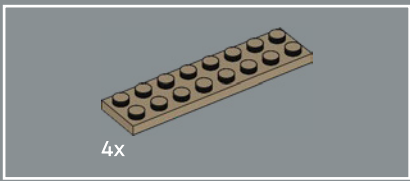

49

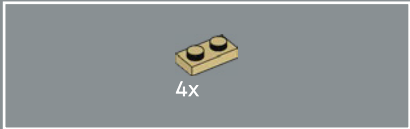
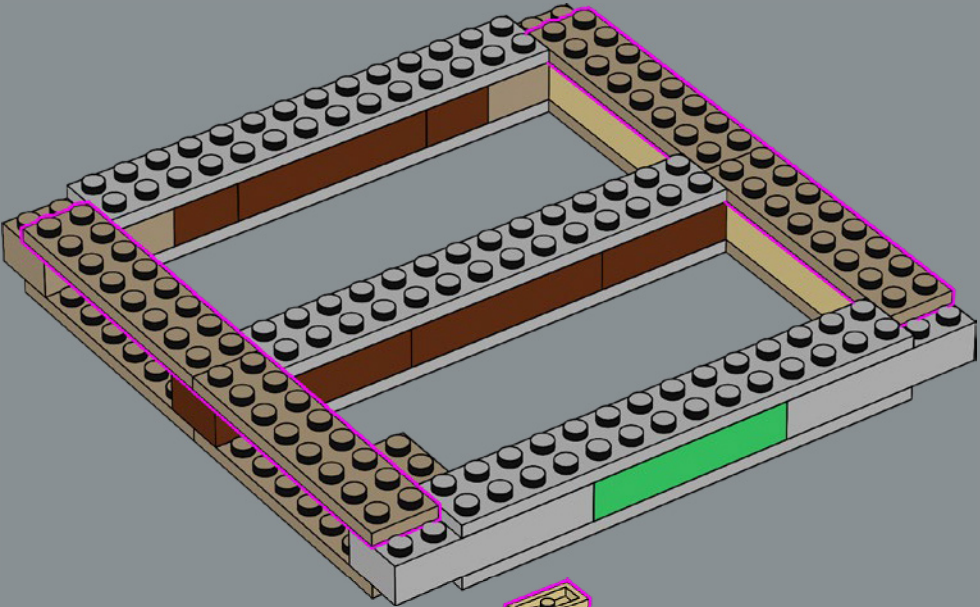

50

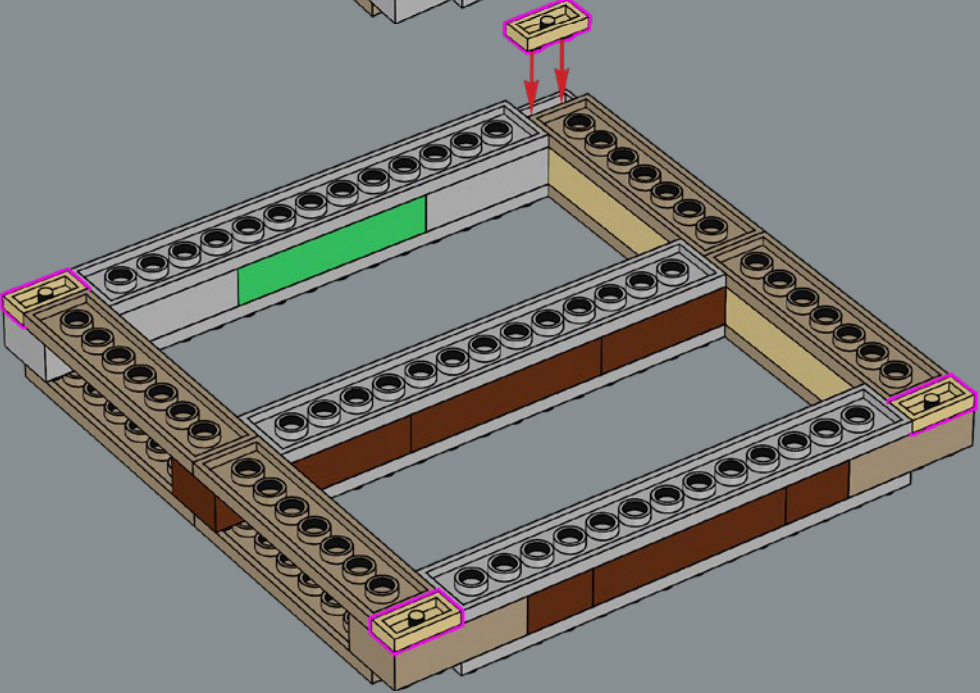



51

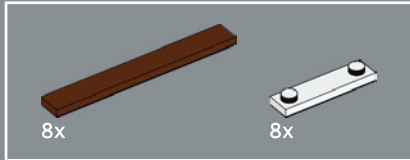
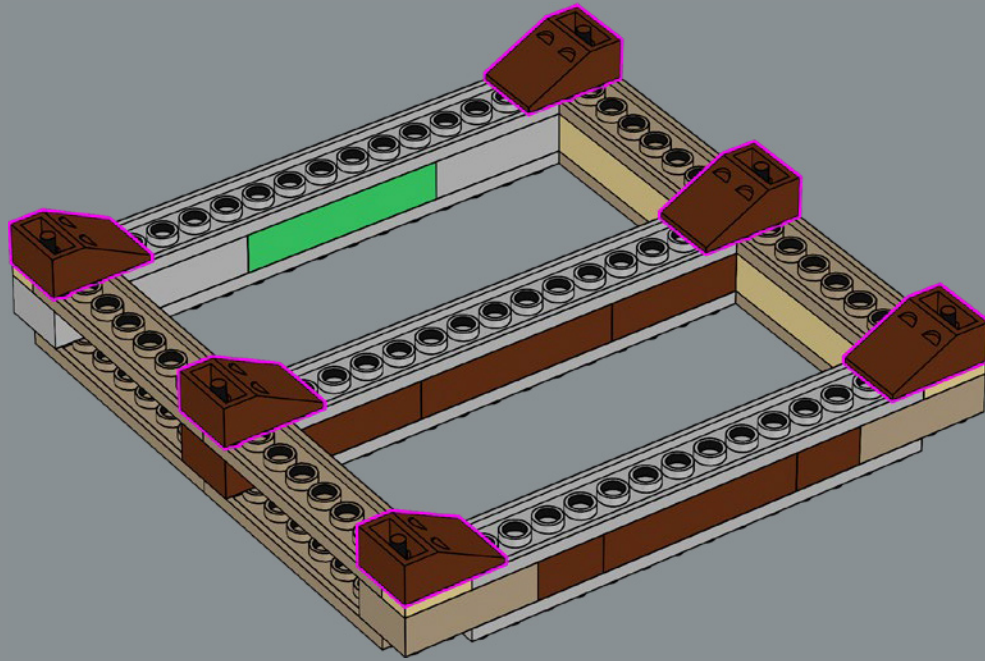

52

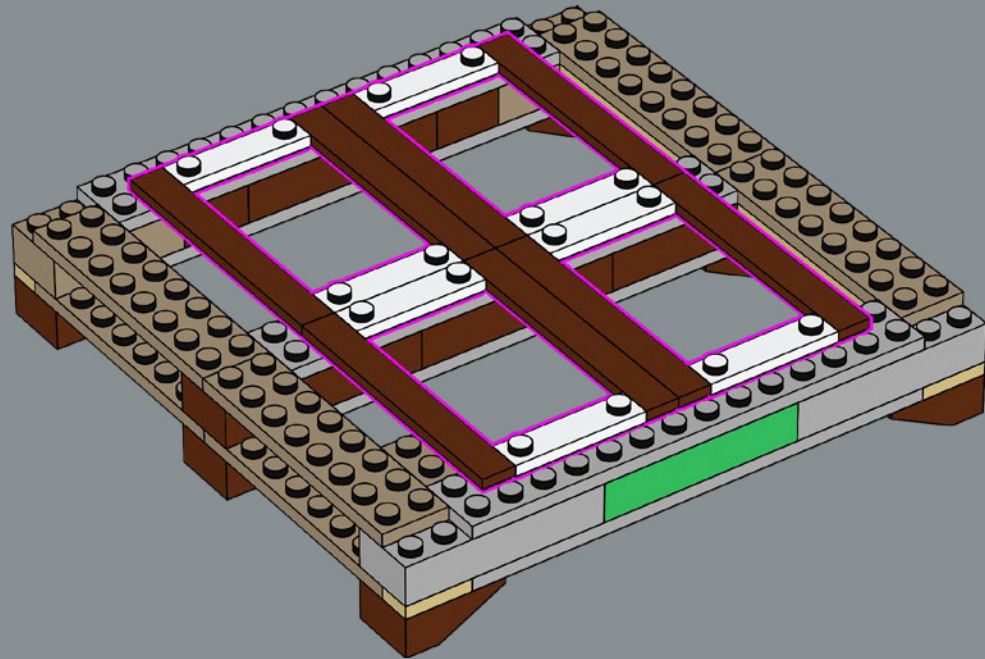

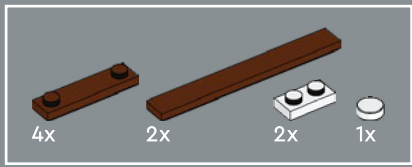

53

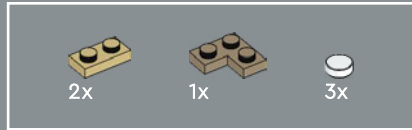
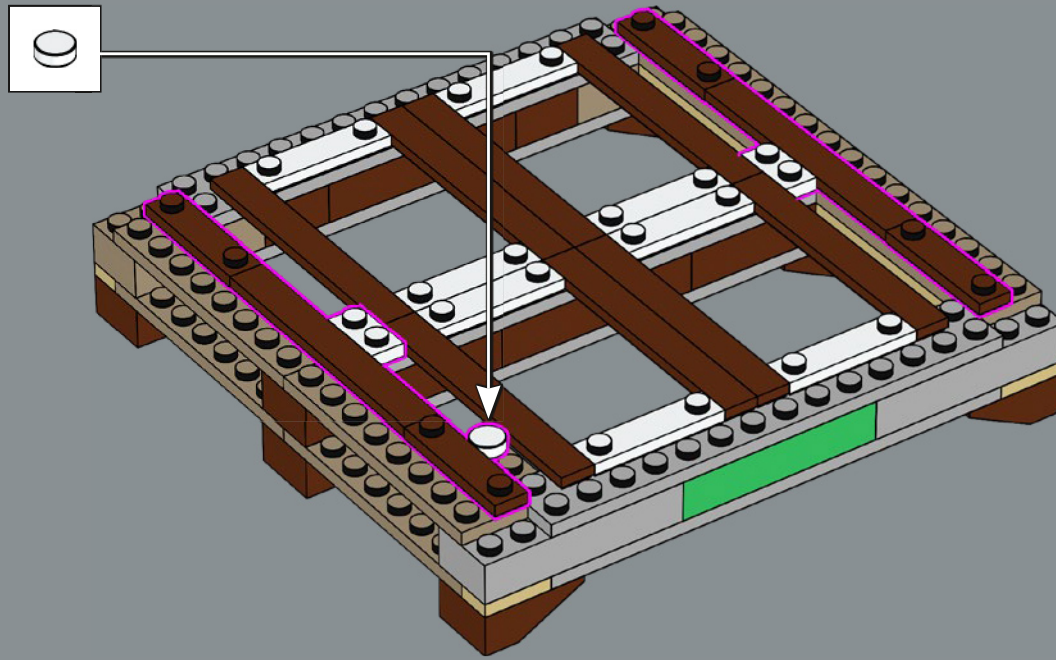

54

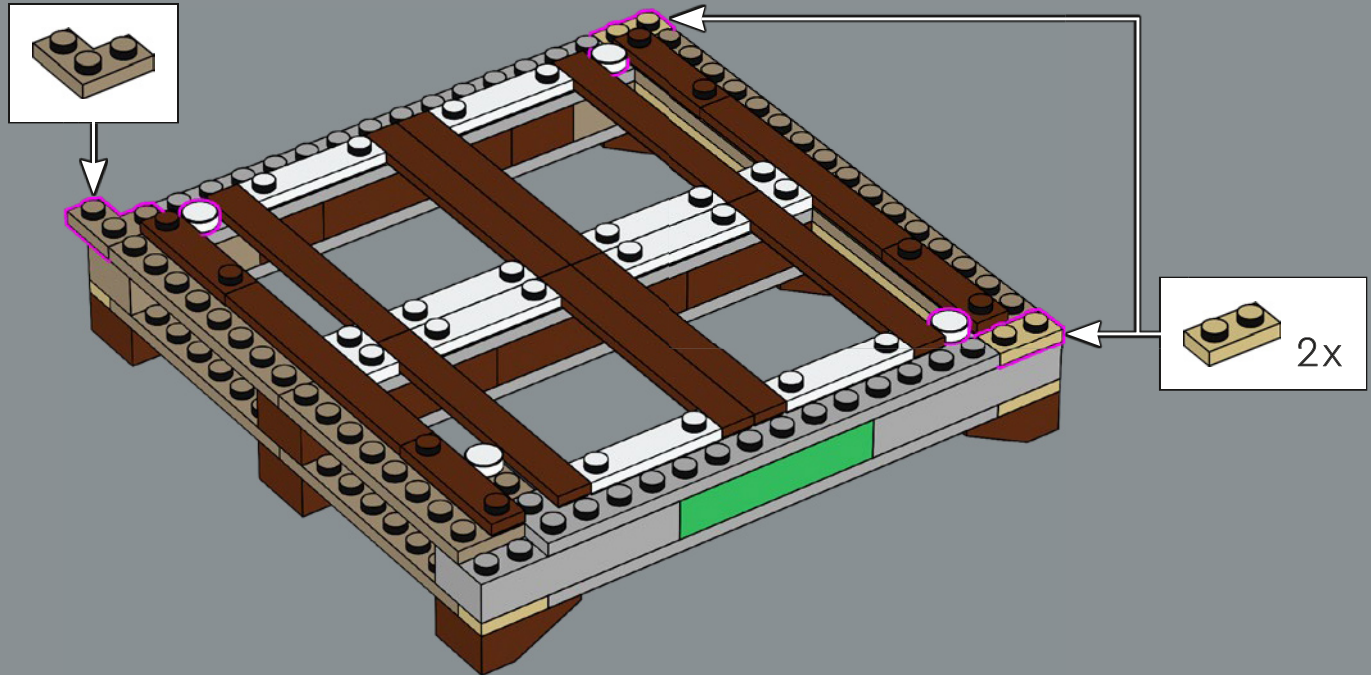

55

Il castello nel modello è supportato da un "vassoio" in mattoncini, progettato per richiamare alla mente le decorazioni bianche e marroni presenti negli interni del castello.

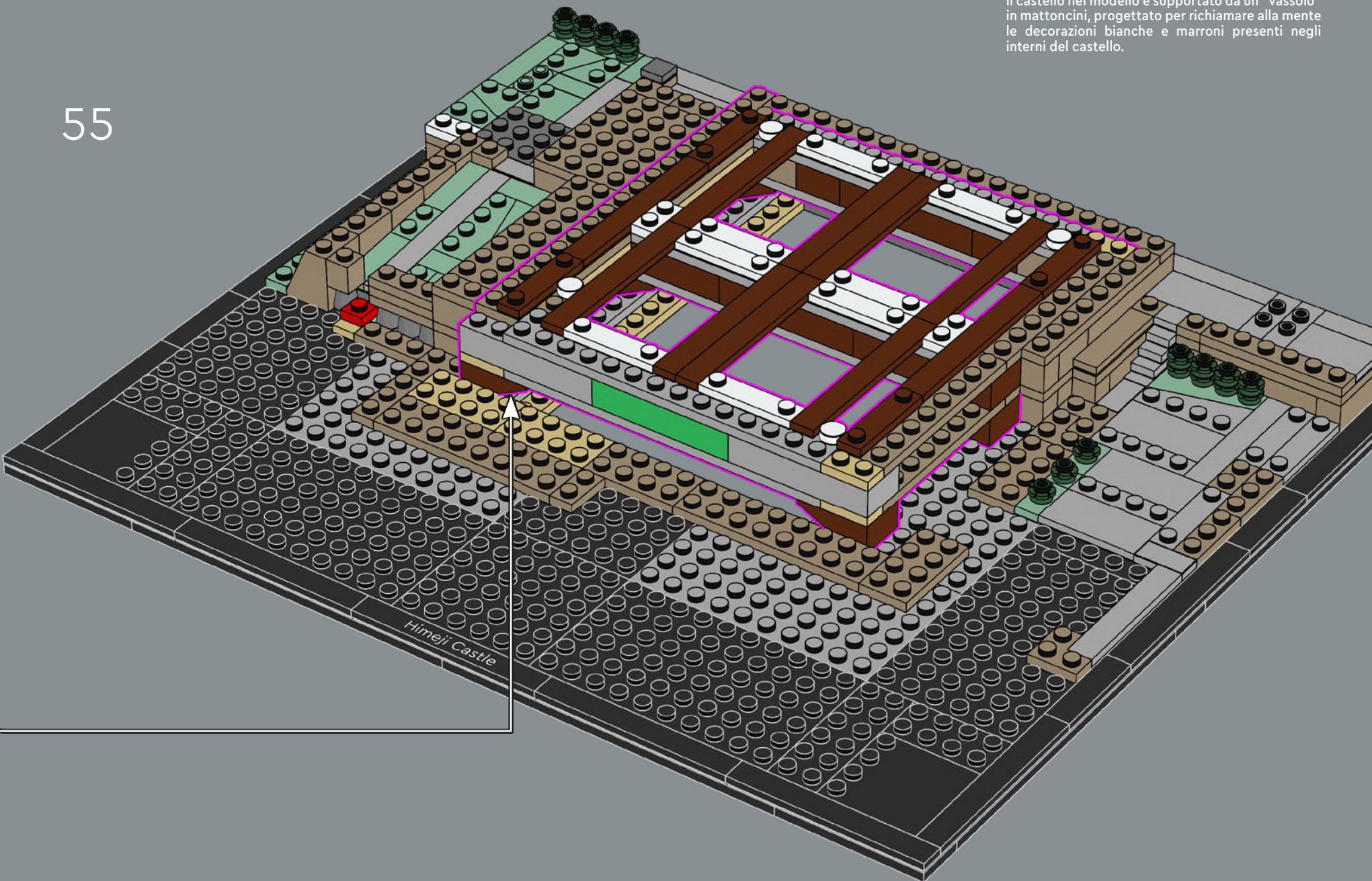

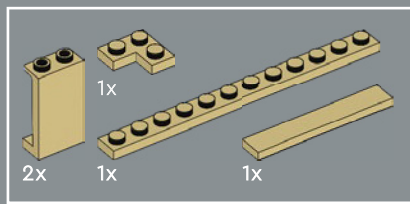

56

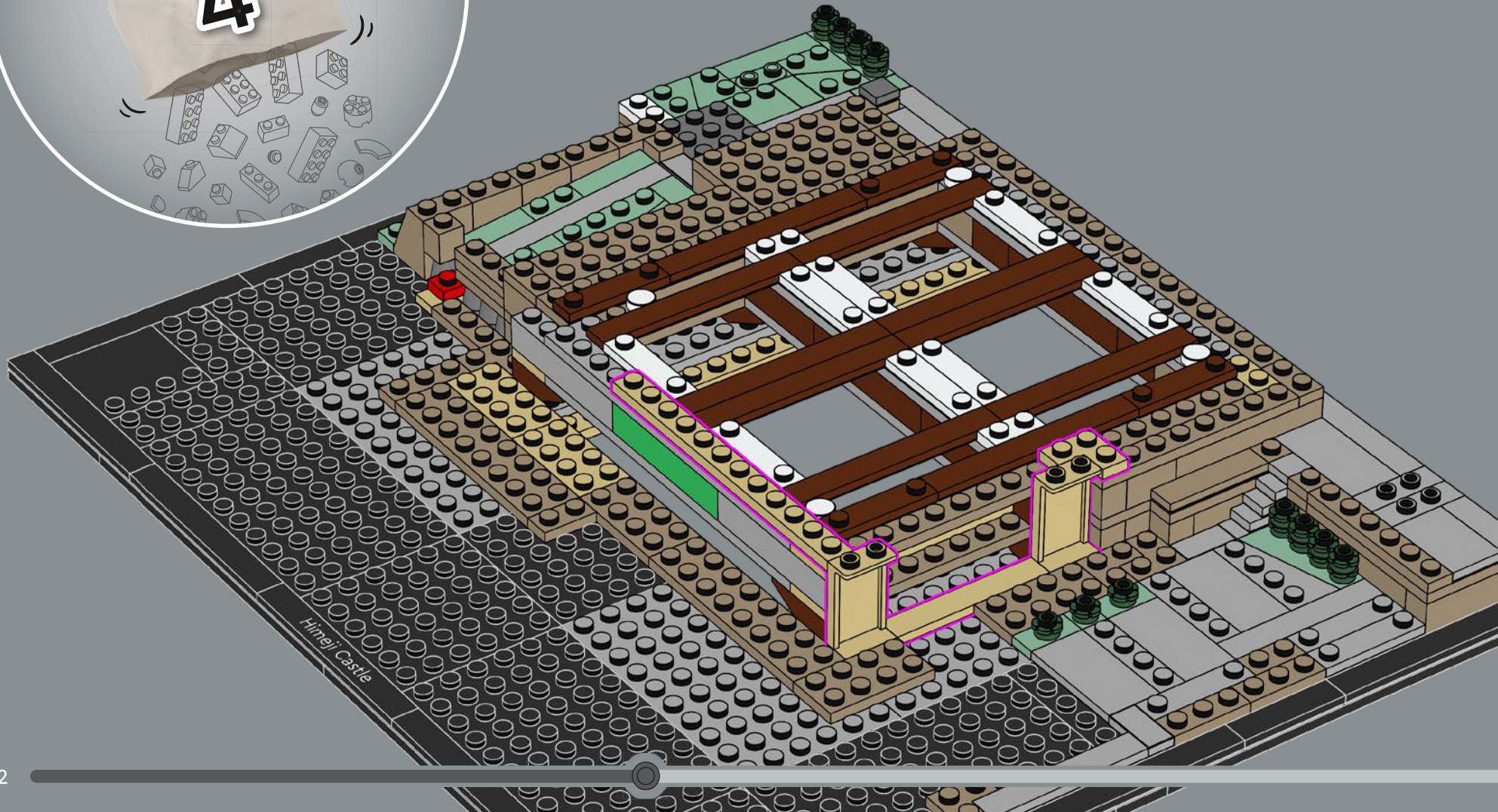

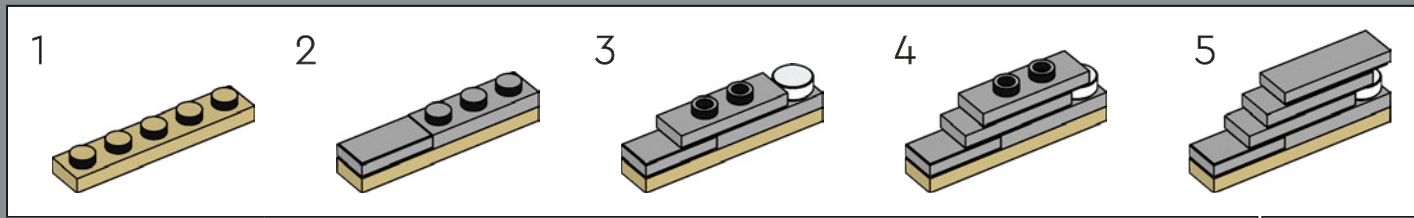
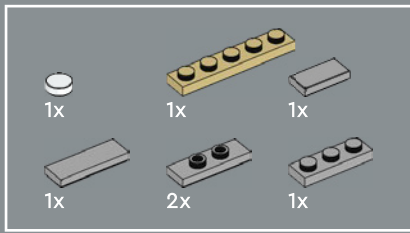

57

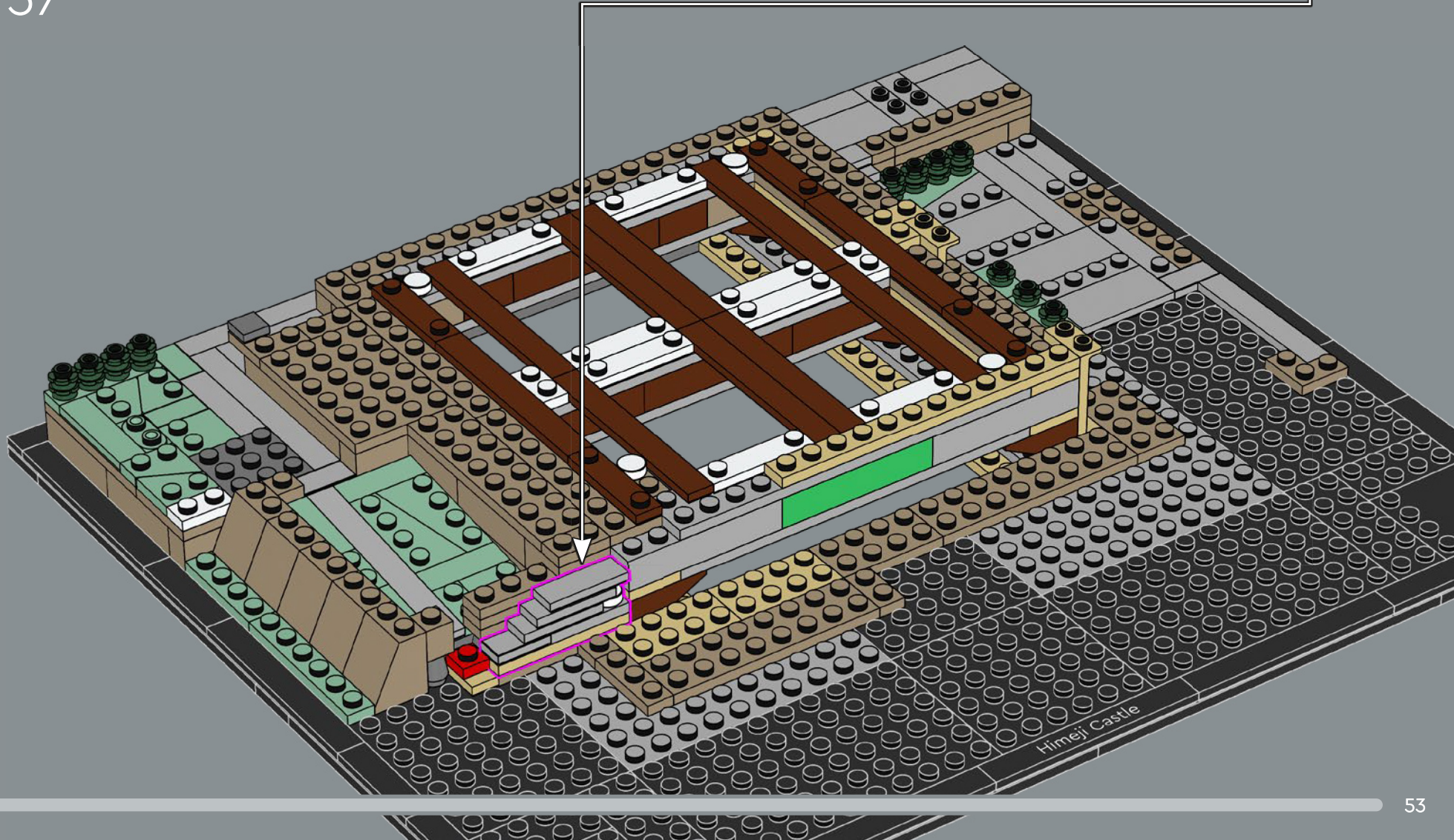

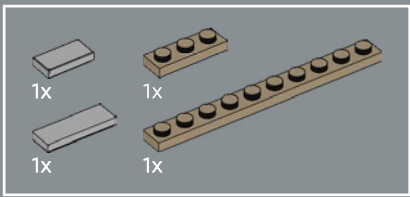

58

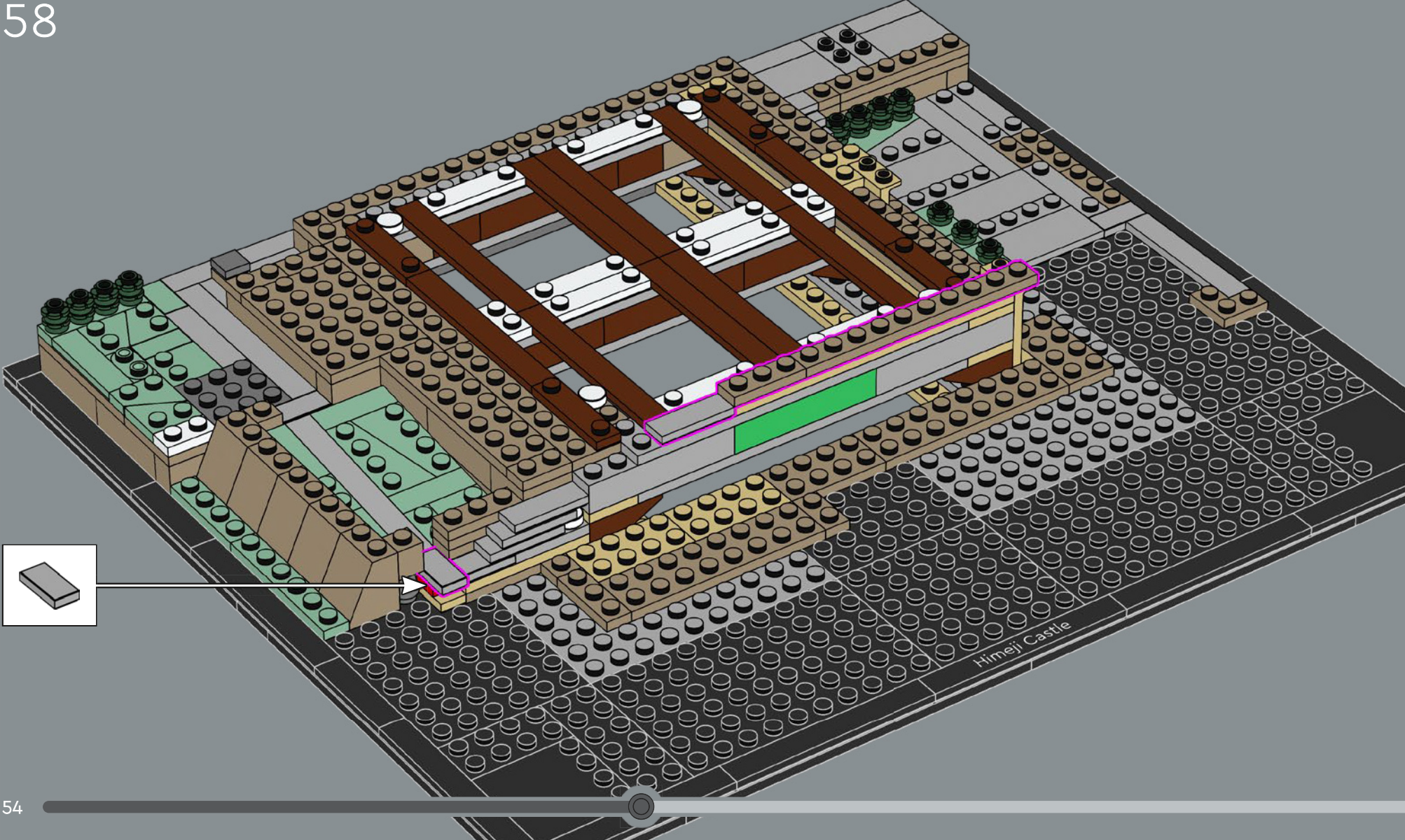

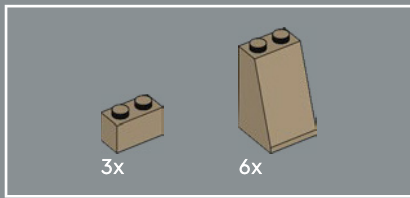

59

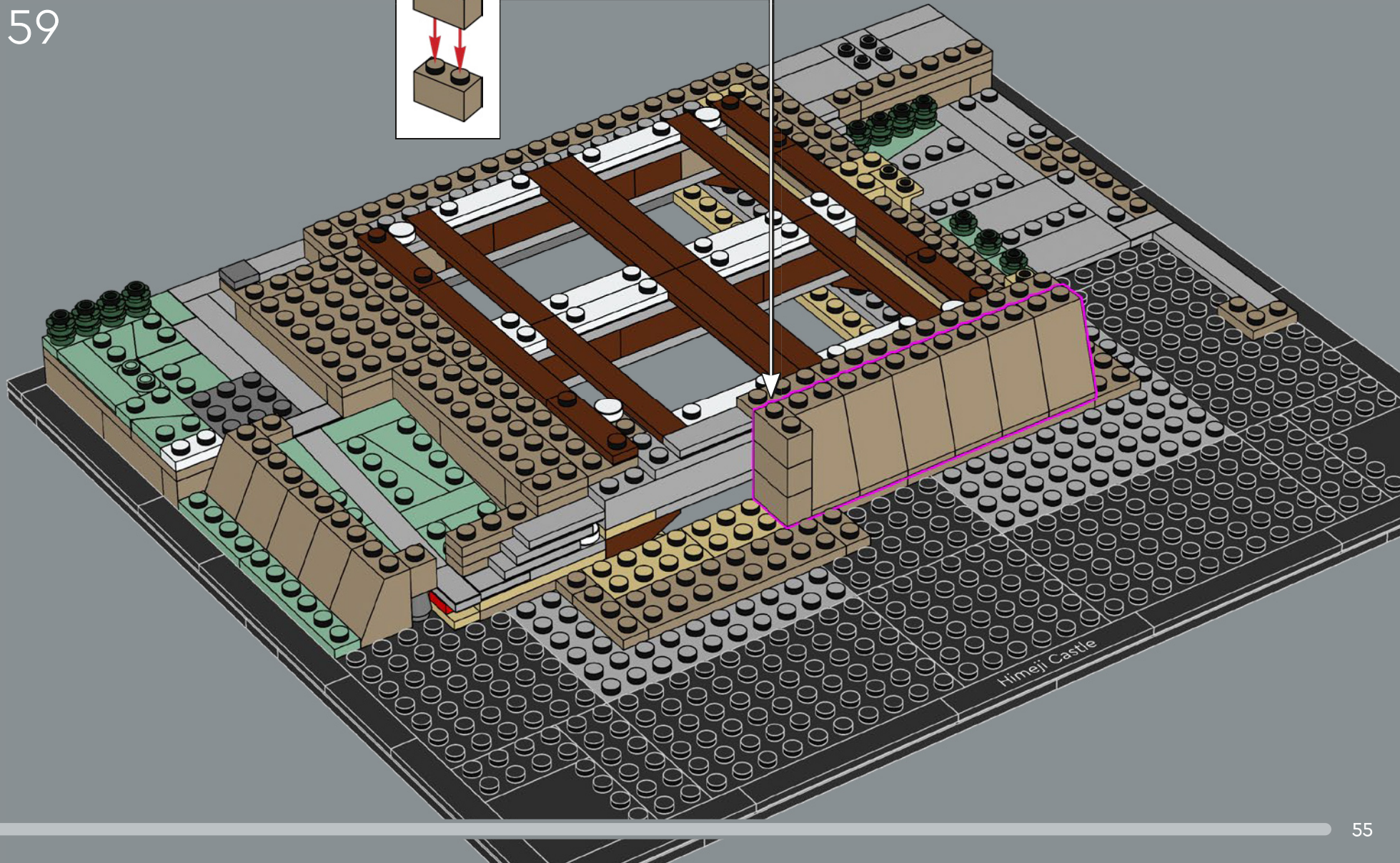
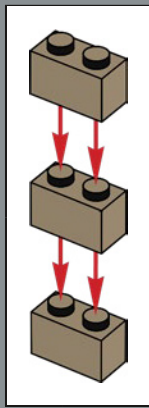

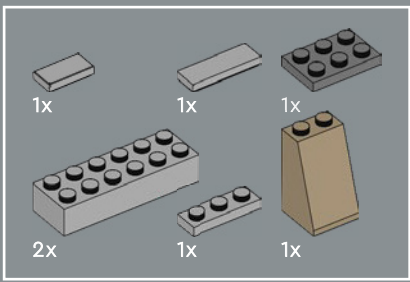

60

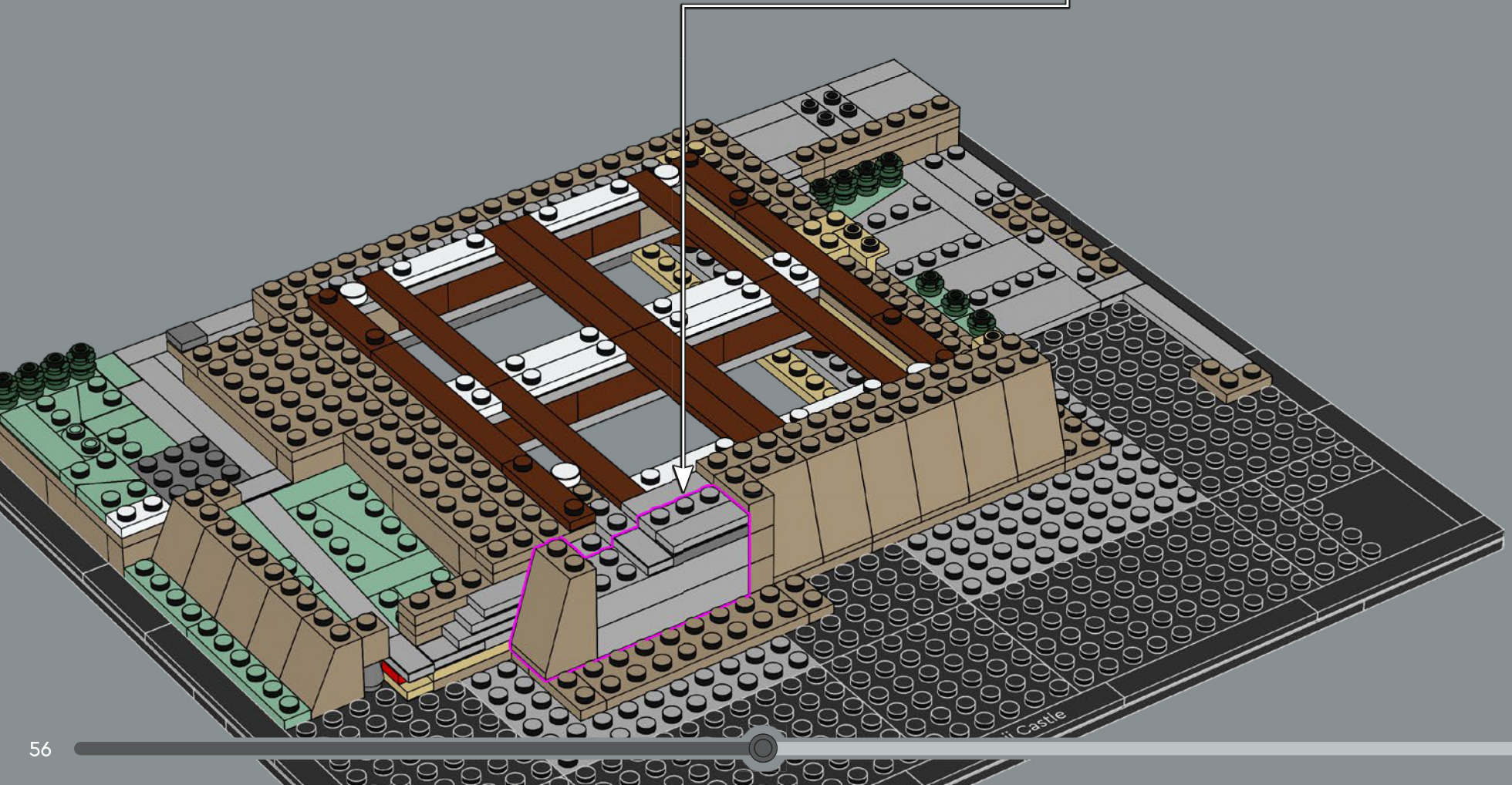
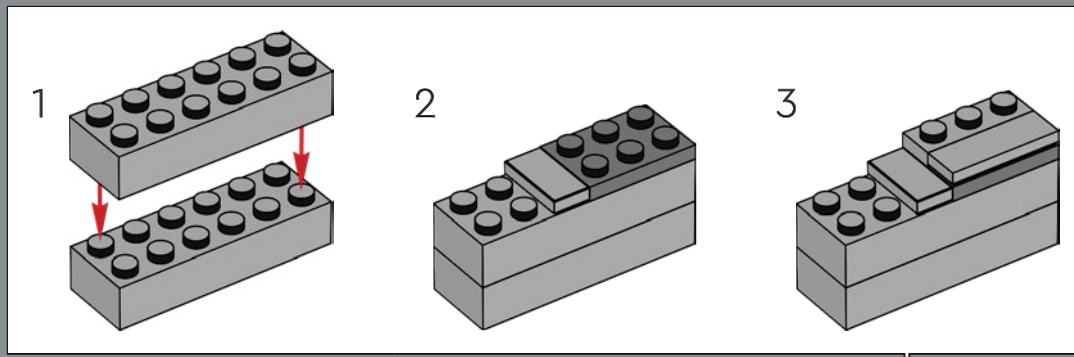

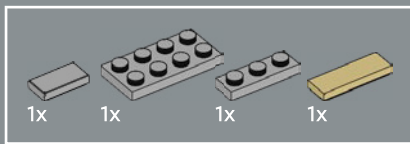

61

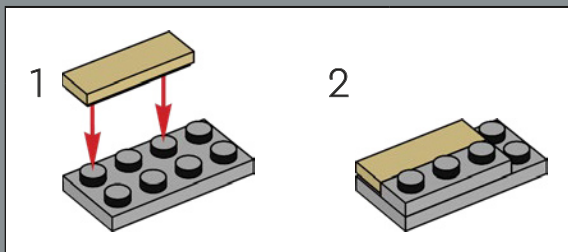
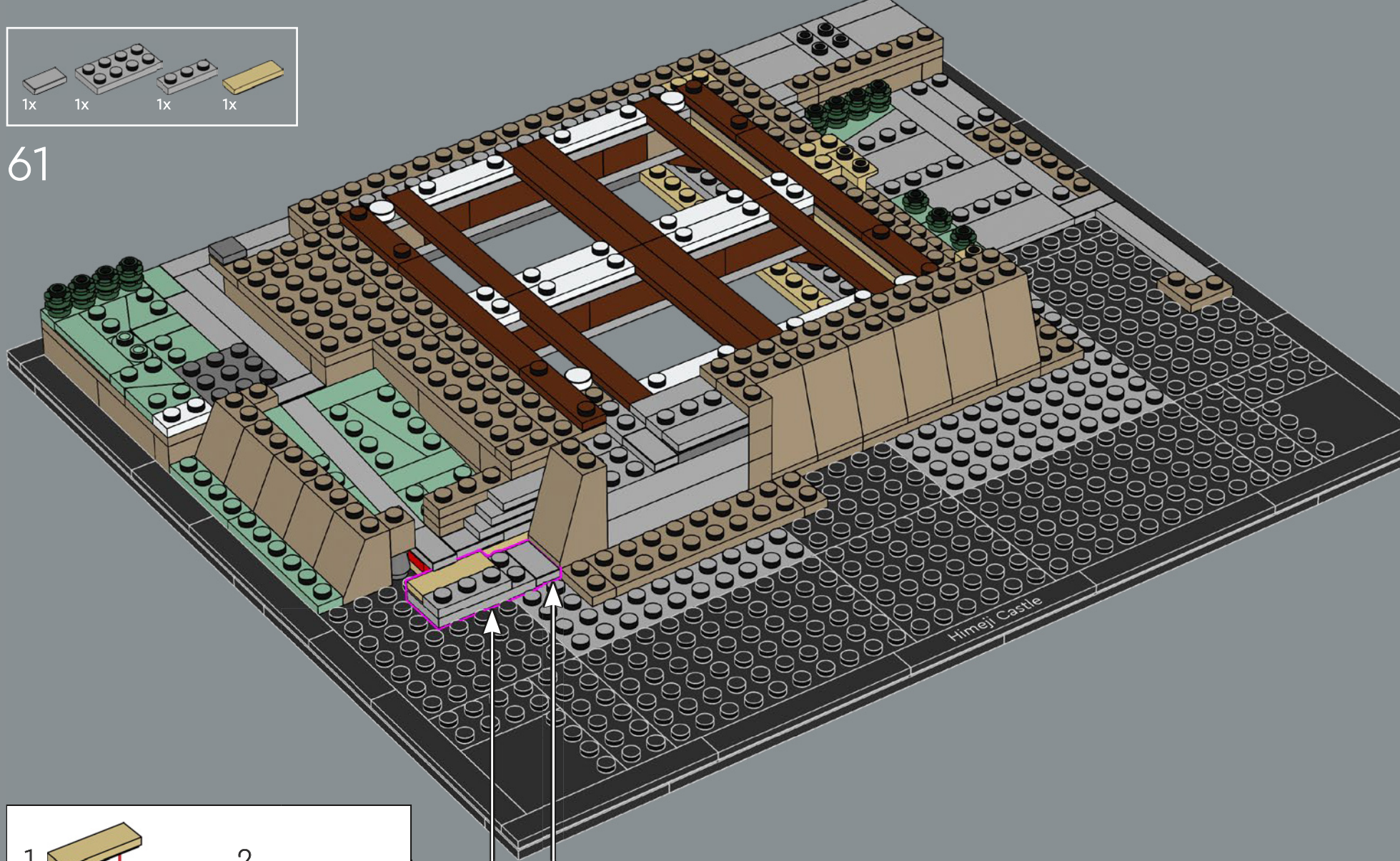

2

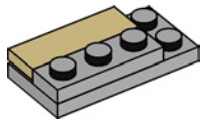

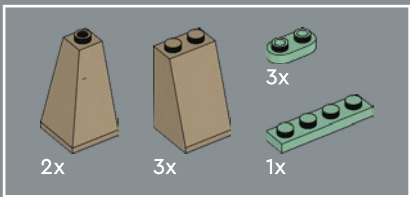

62

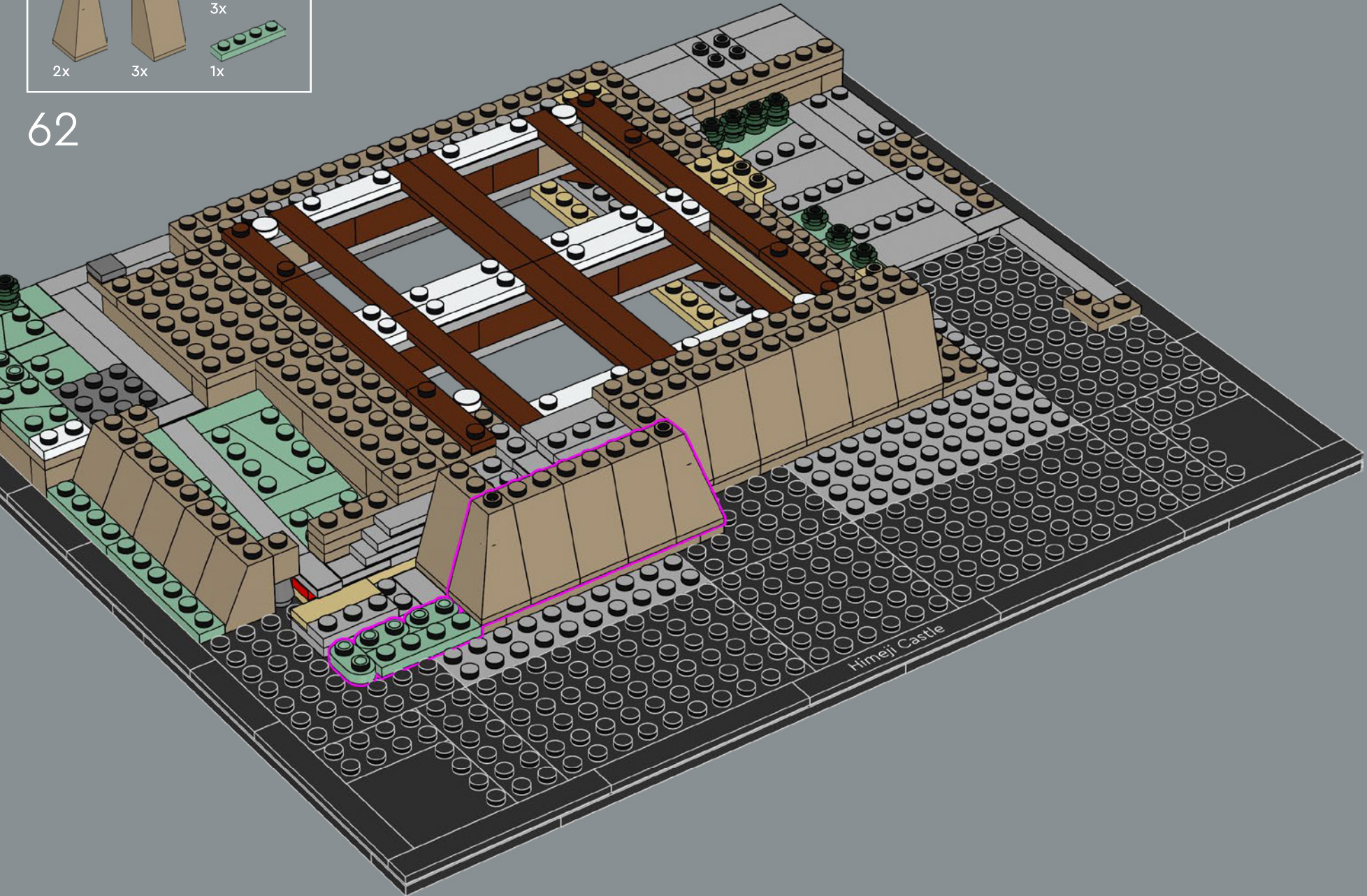

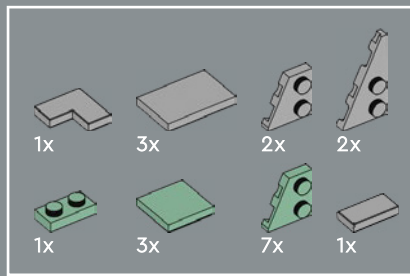

63

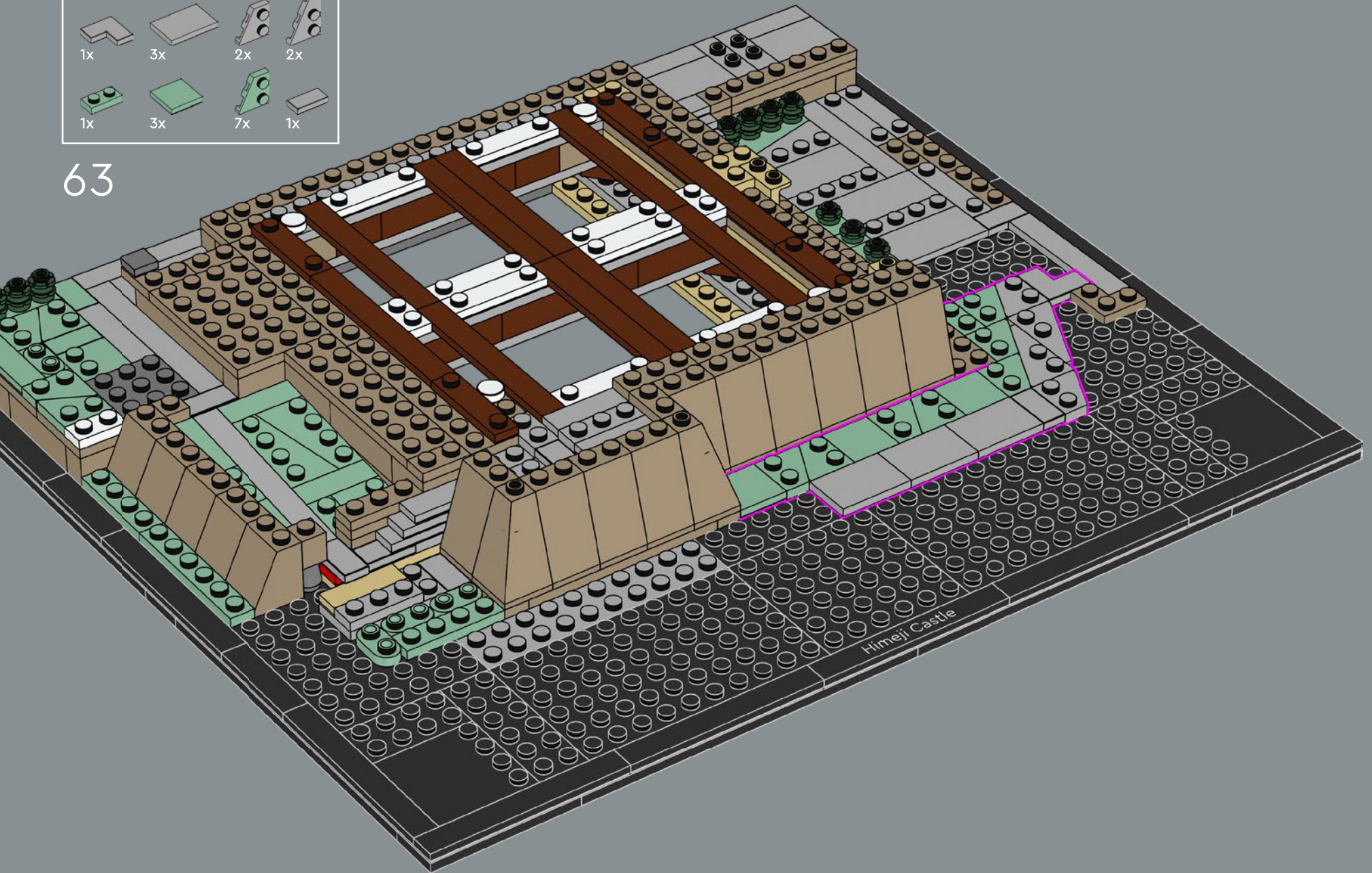

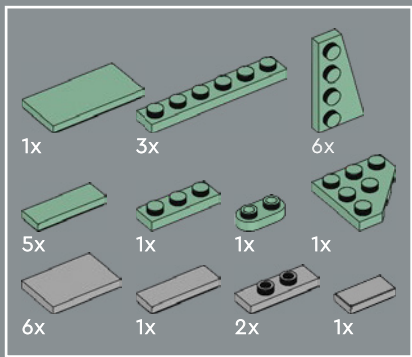

64

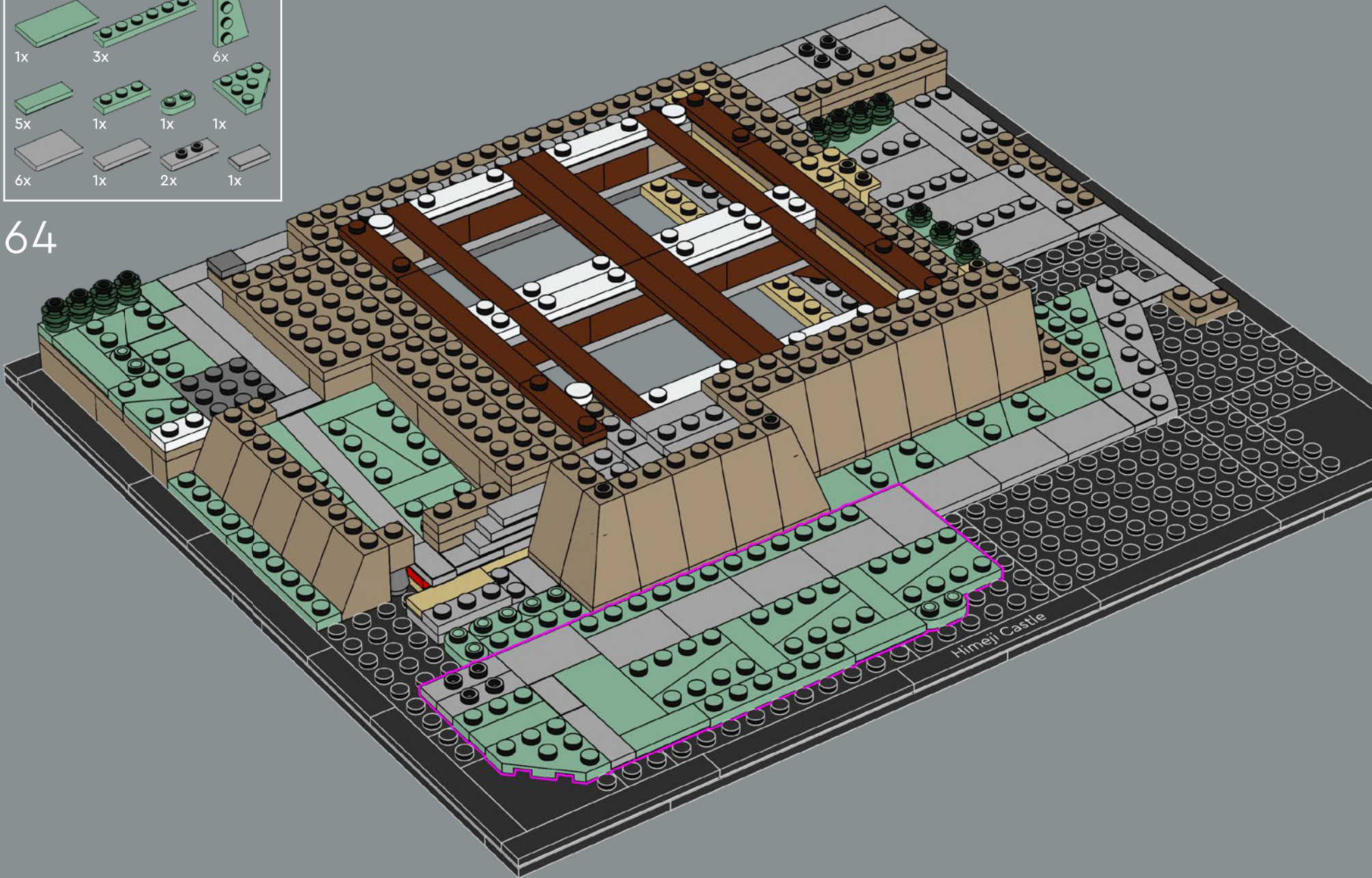

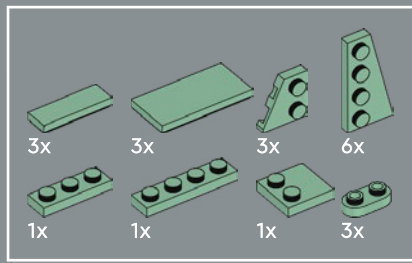

65

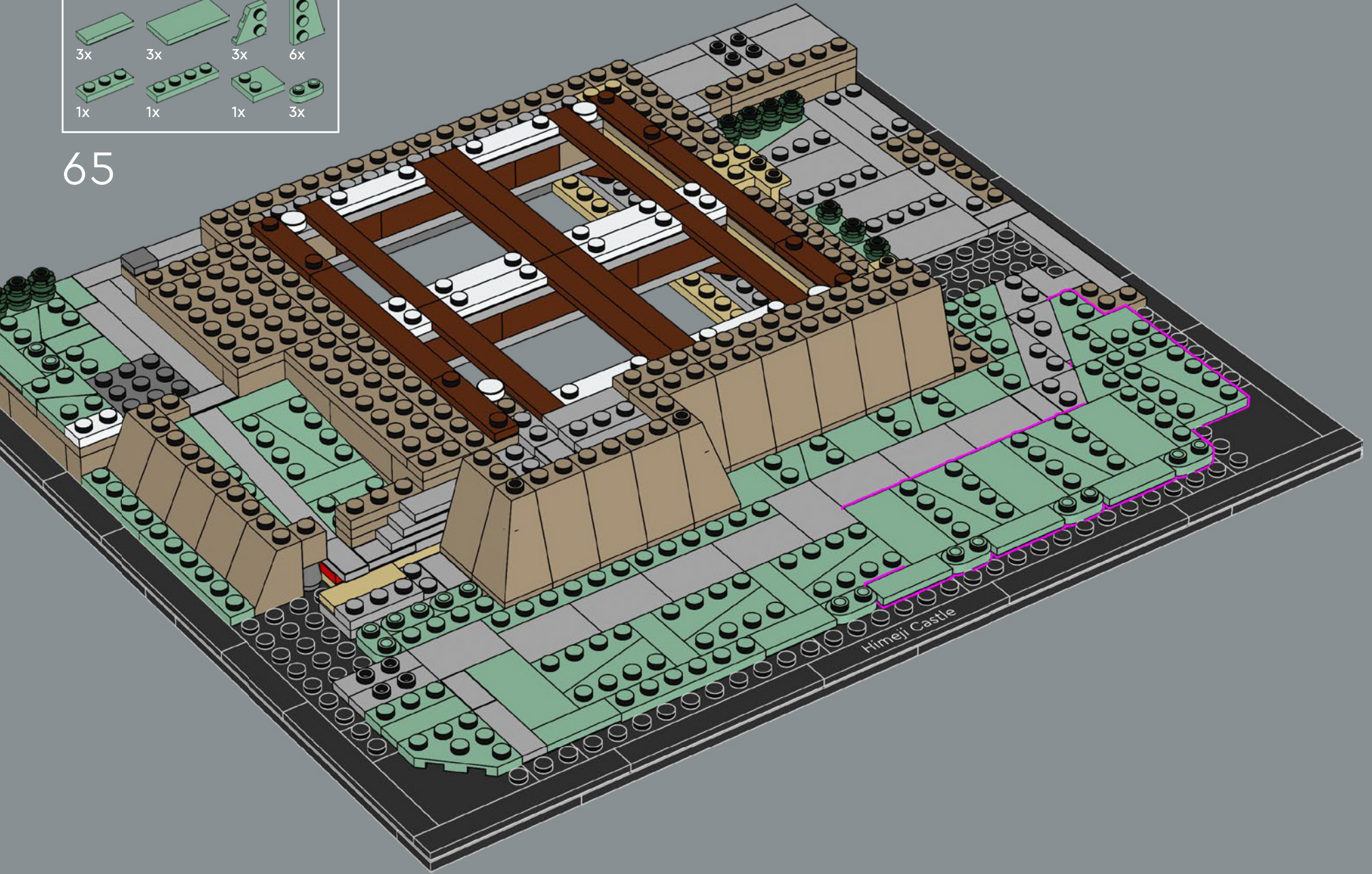

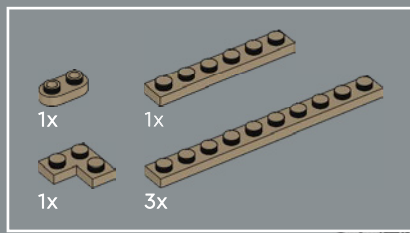

66

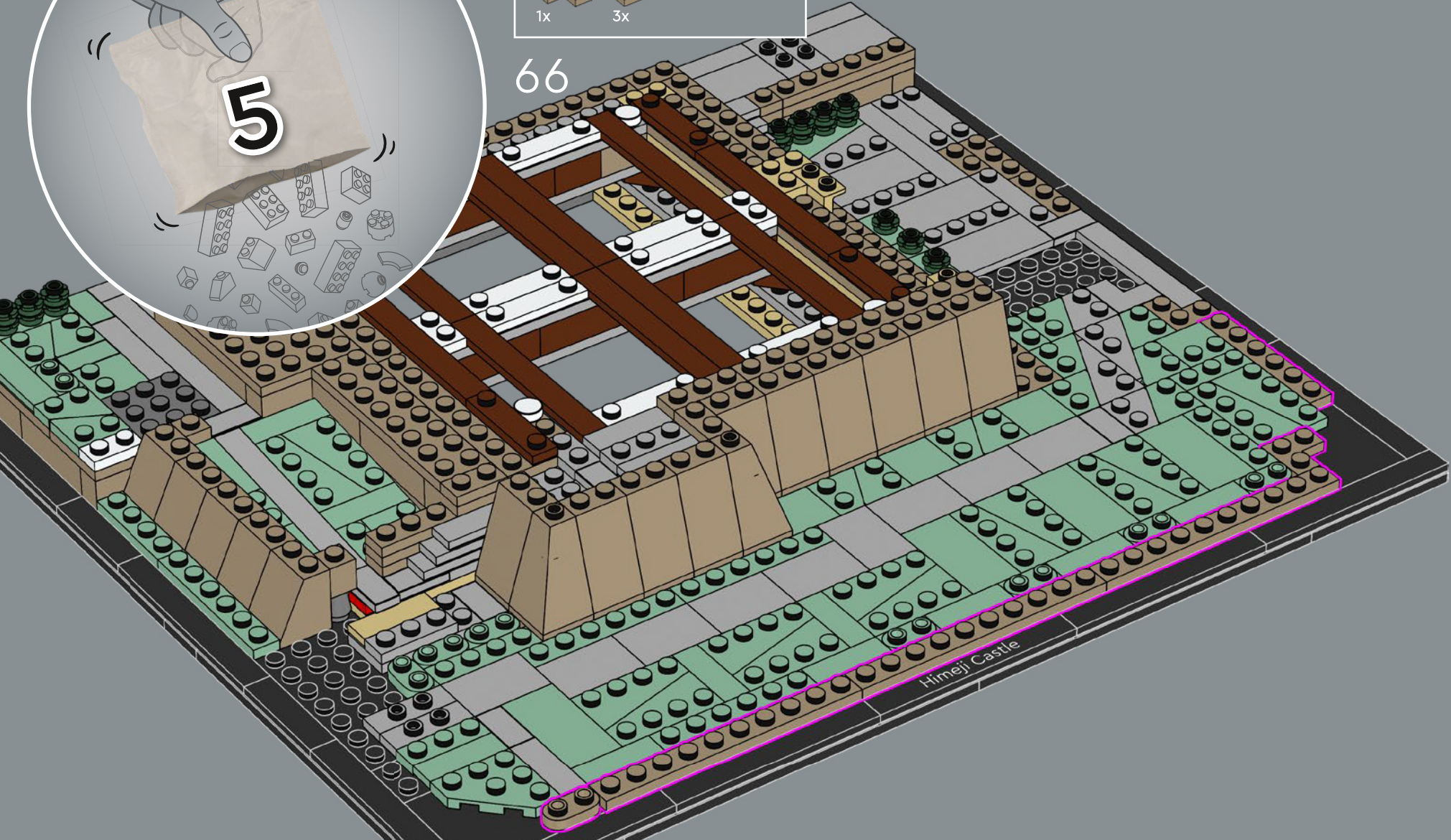

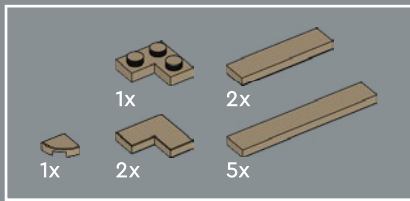

67

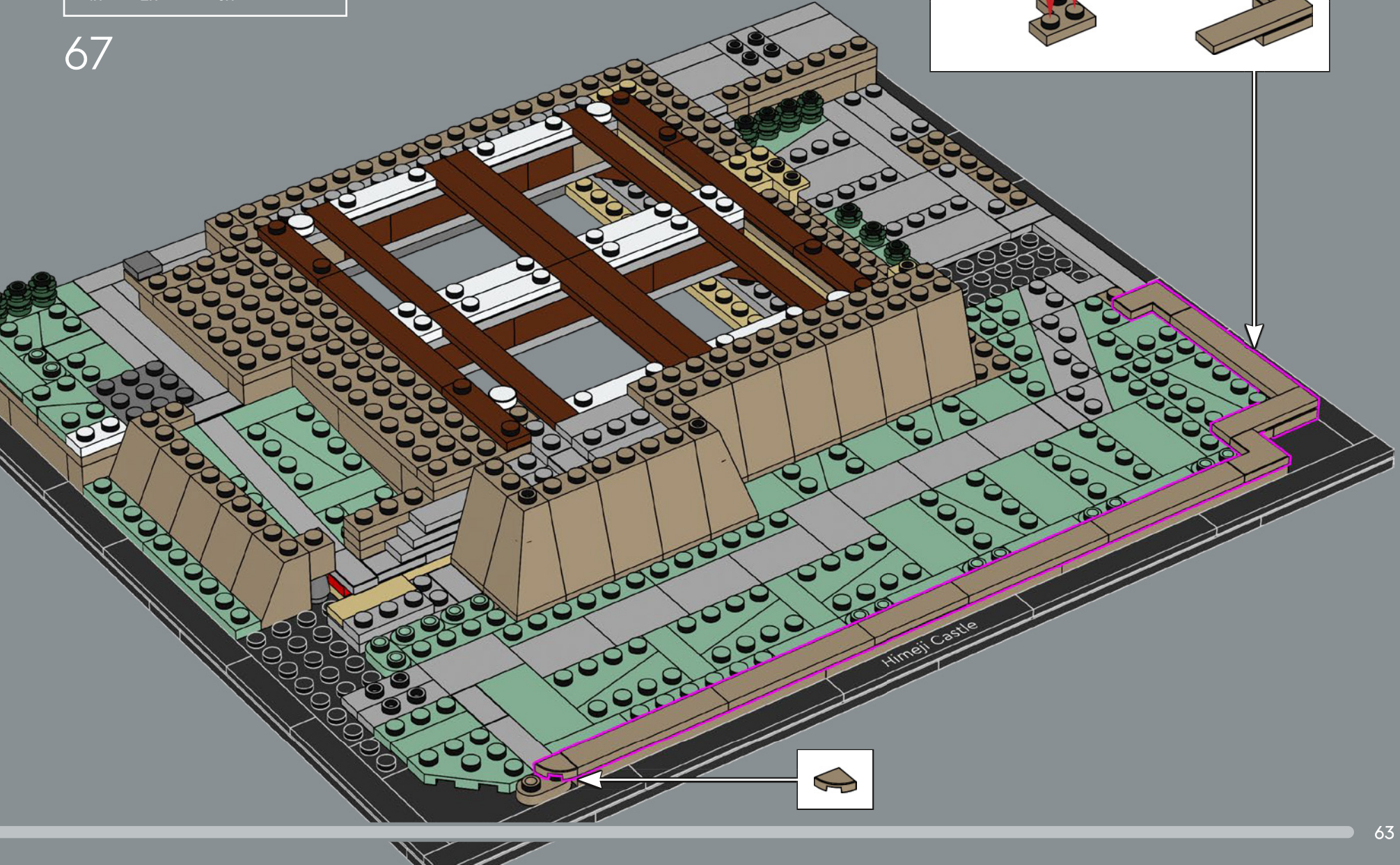
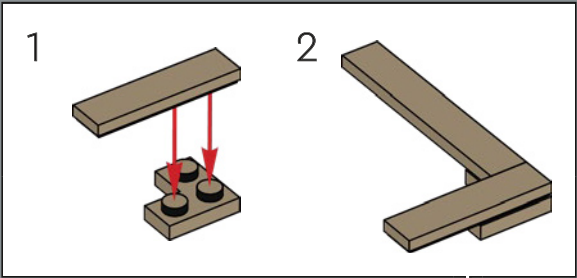

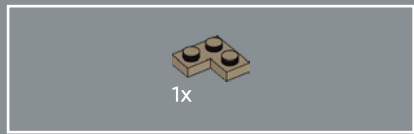

68

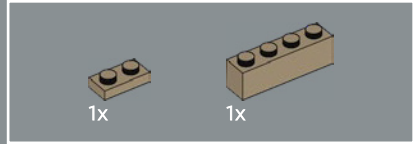

69

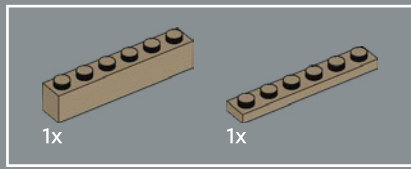
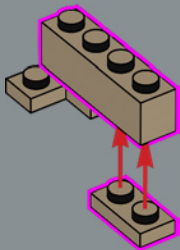

70

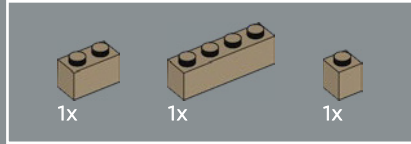
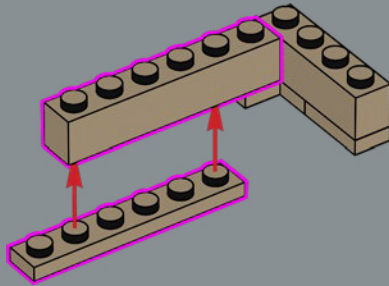

71

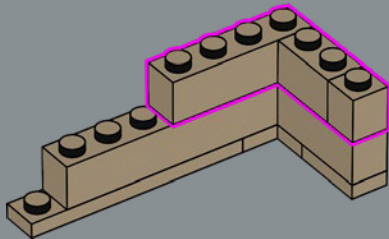

72

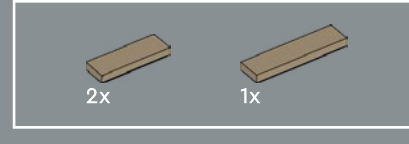
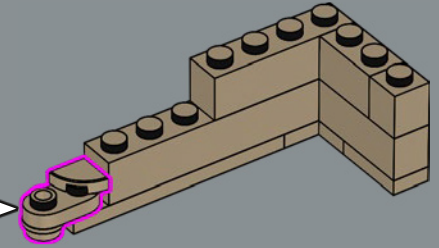
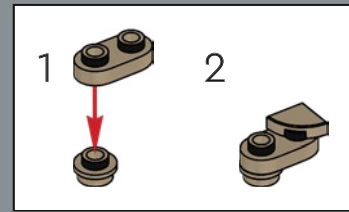

73

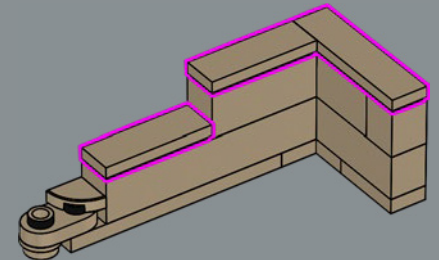

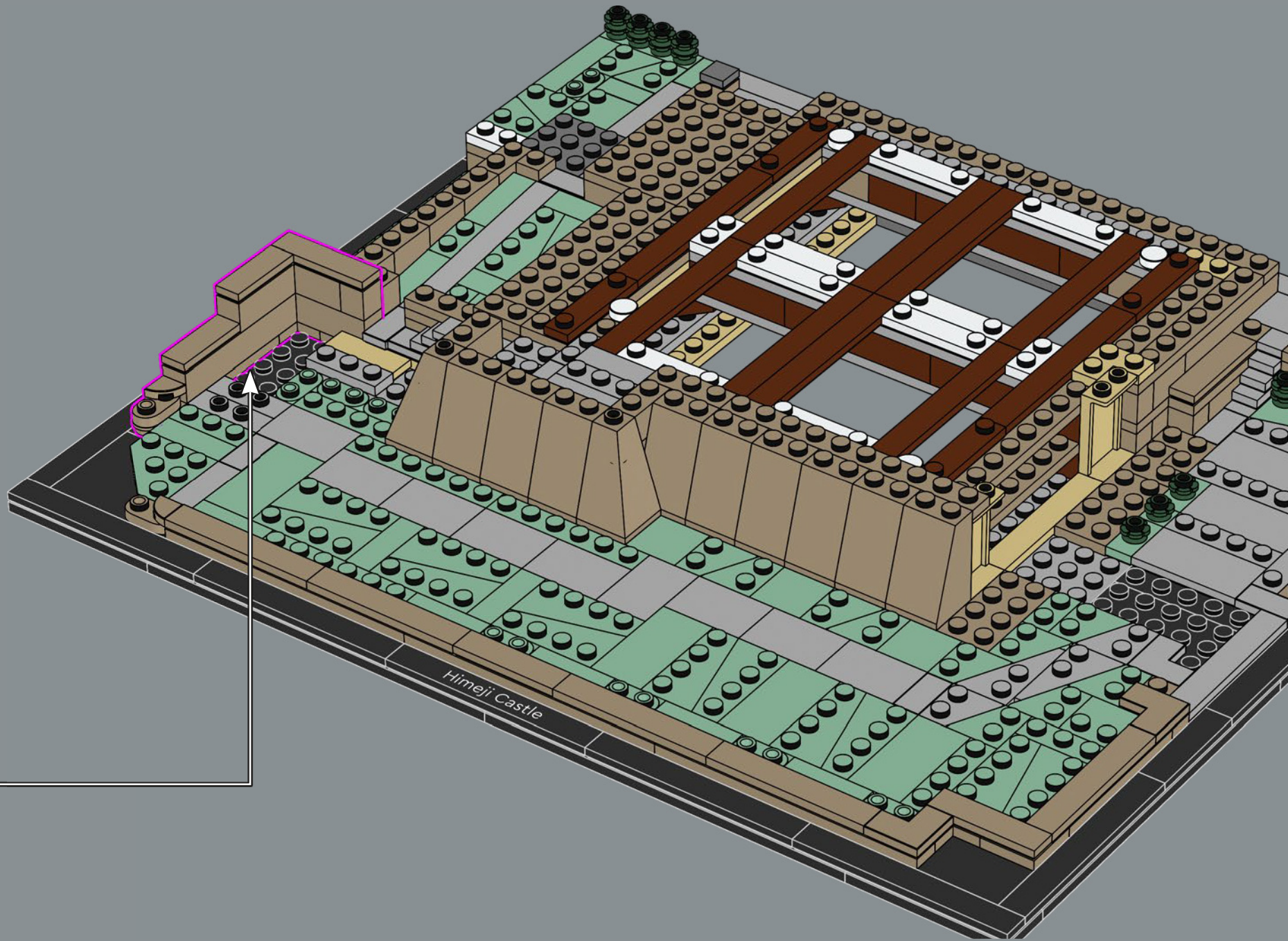

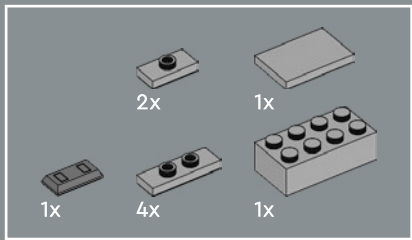

75

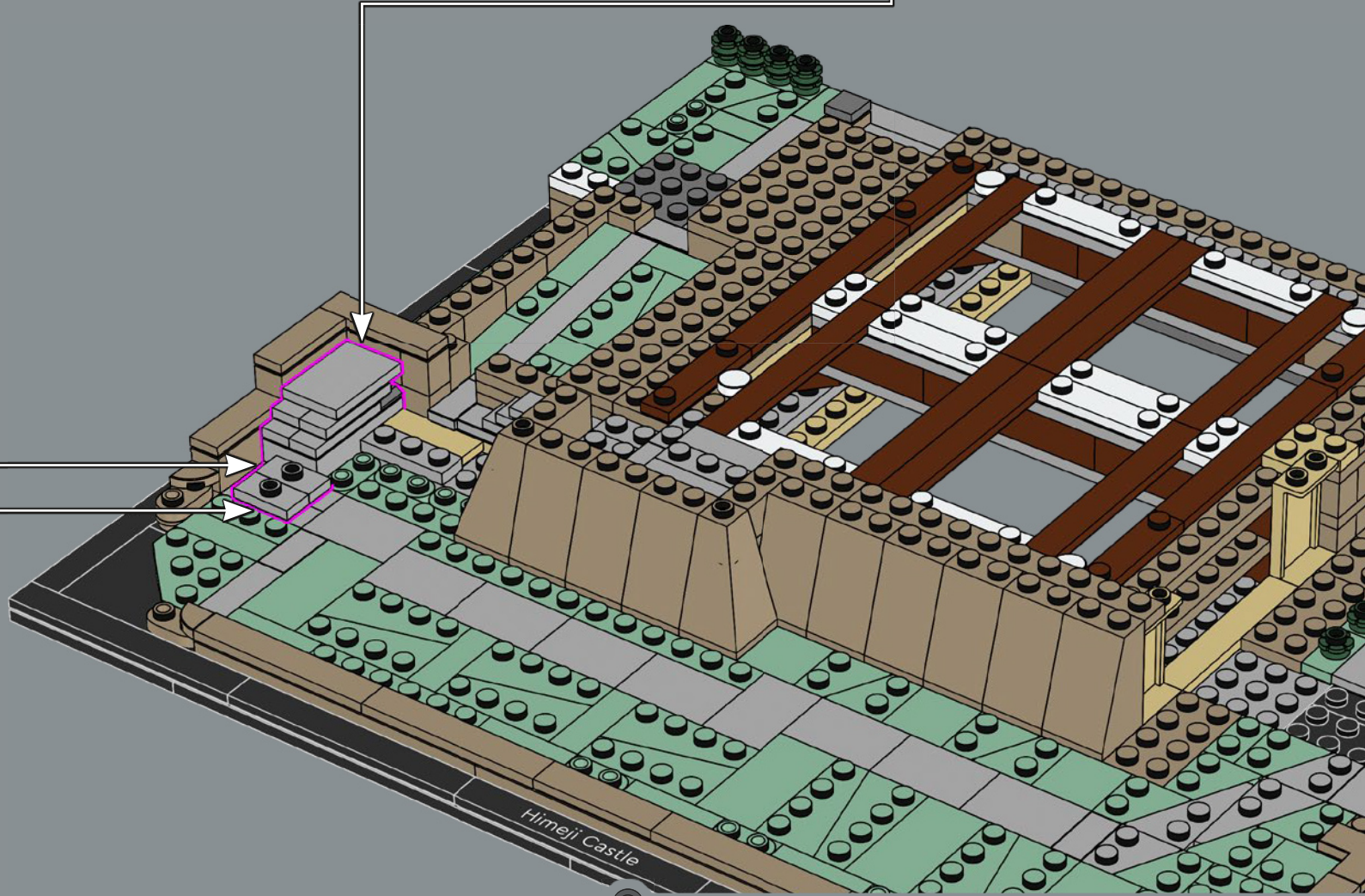
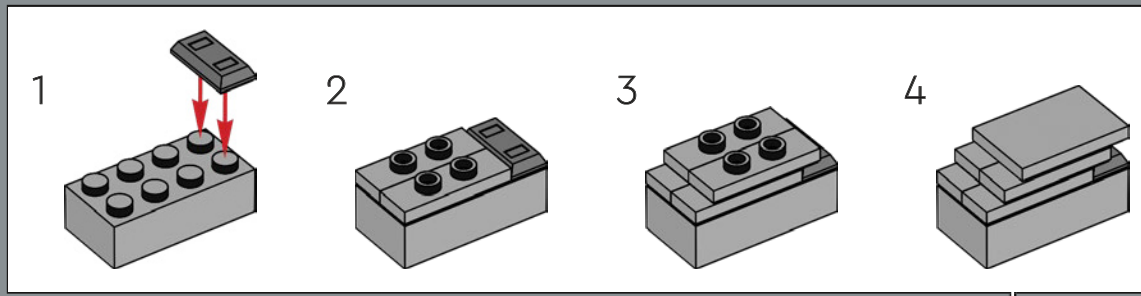

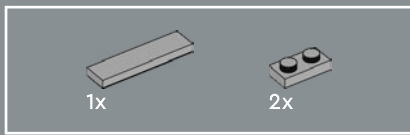

76

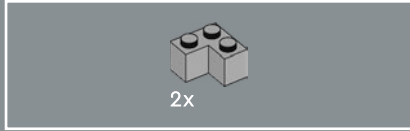
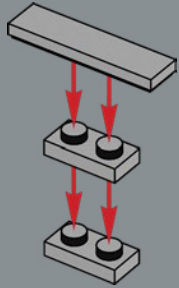

77

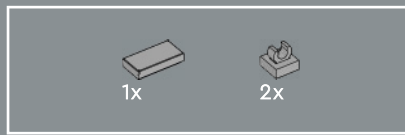
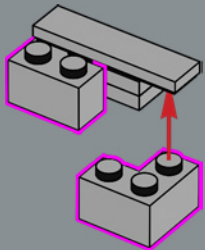

78

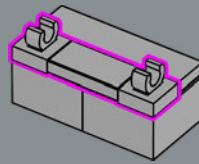

79

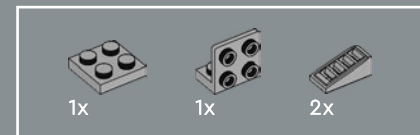
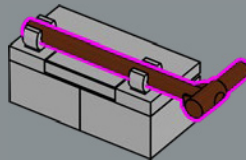

80

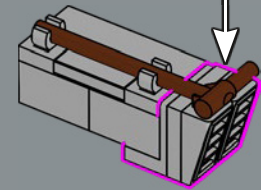
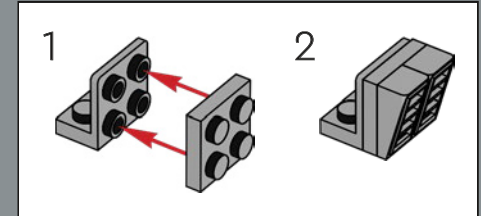

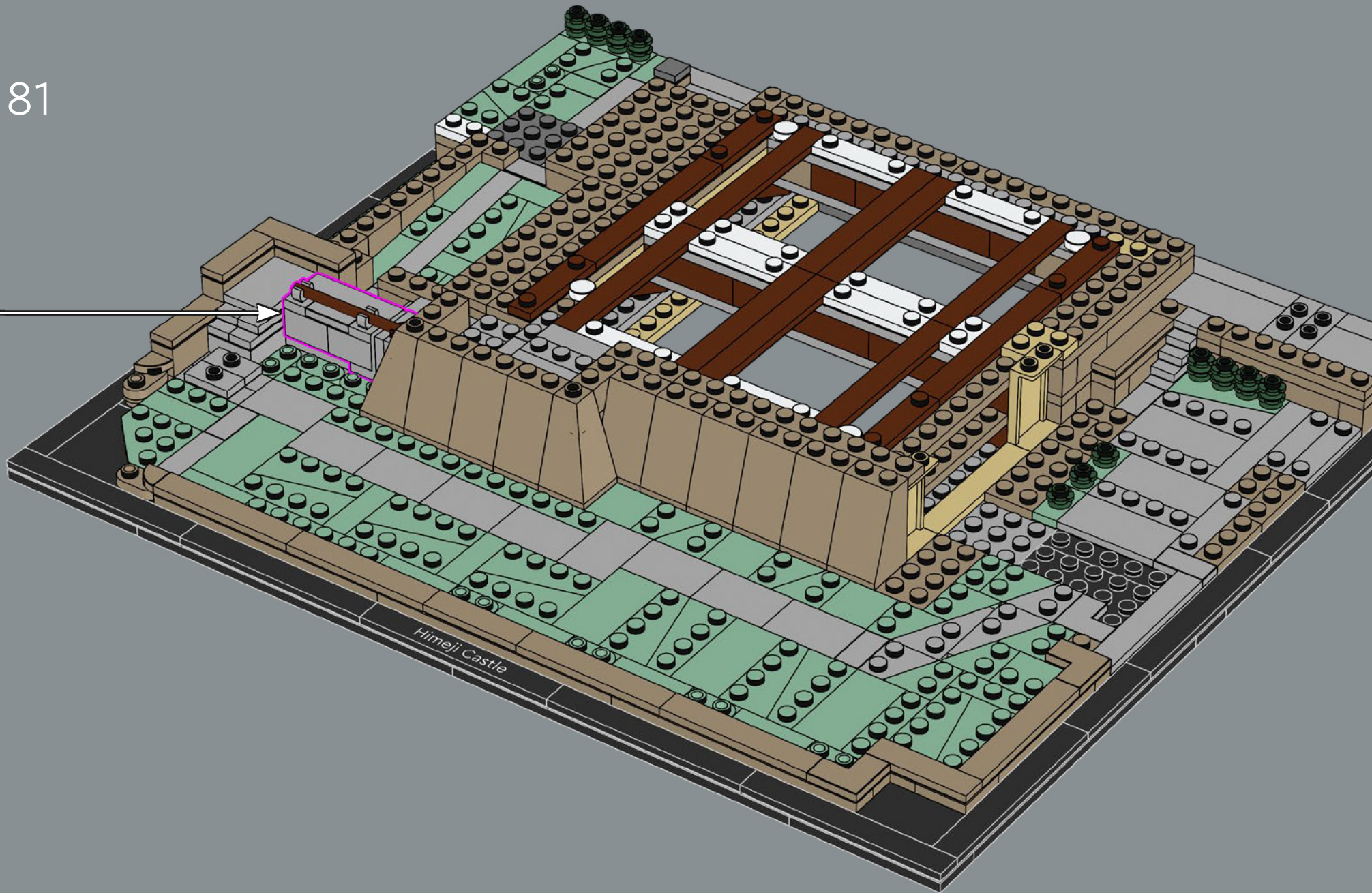

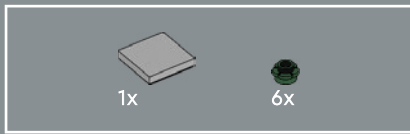

82

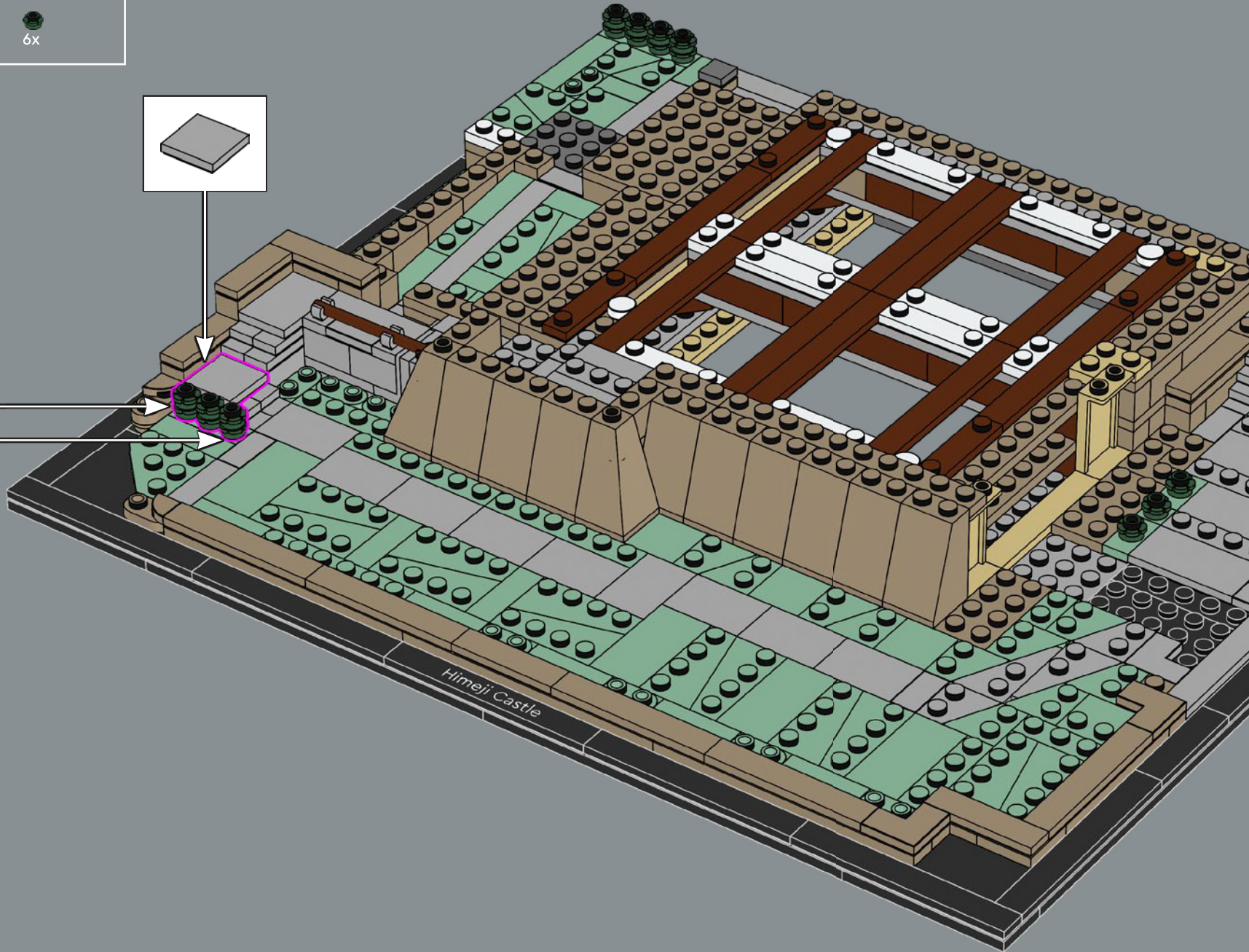
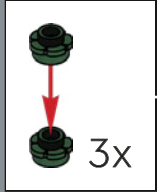
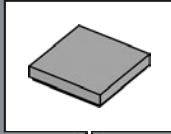

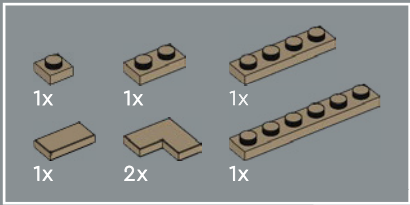

83

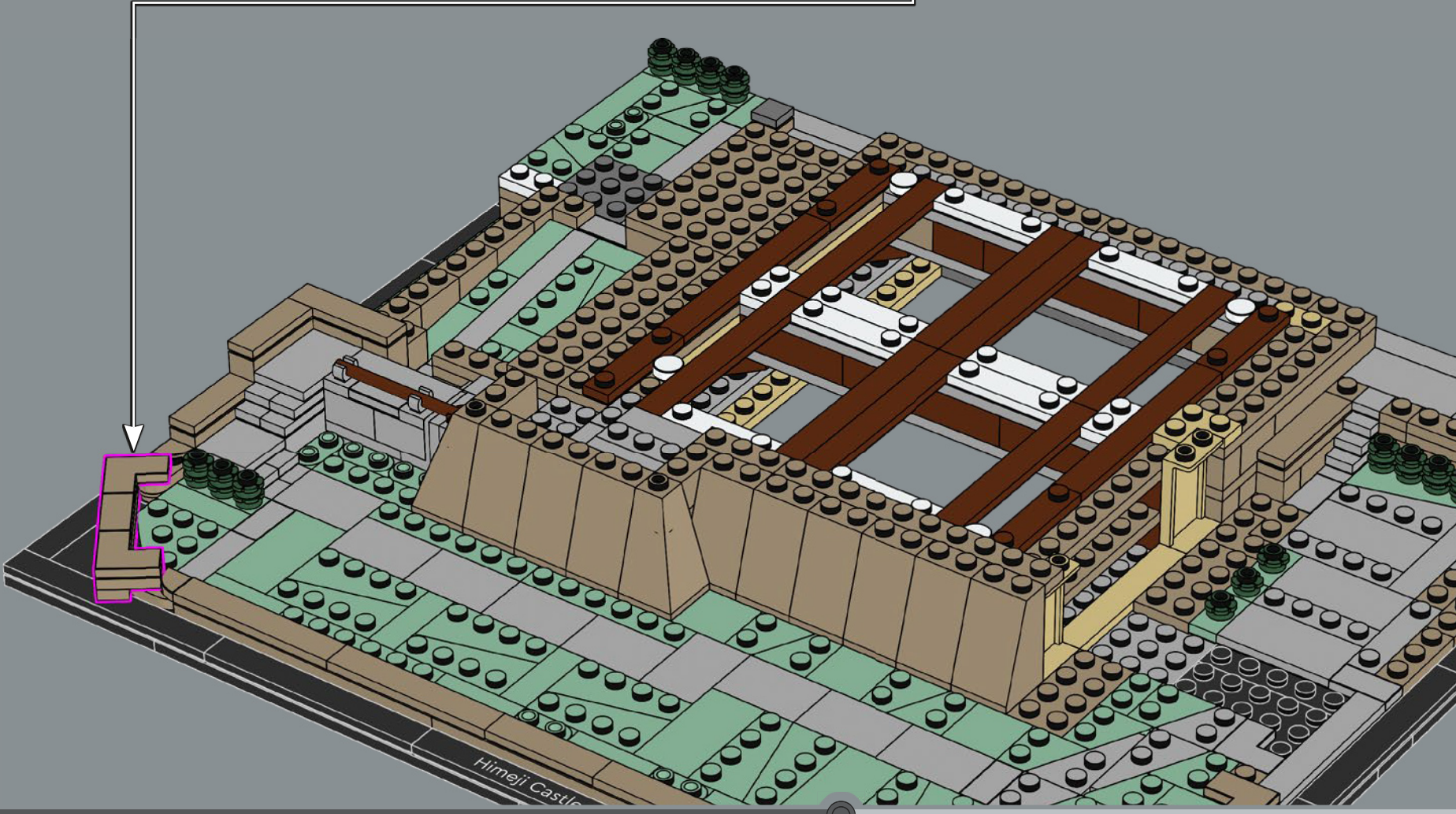
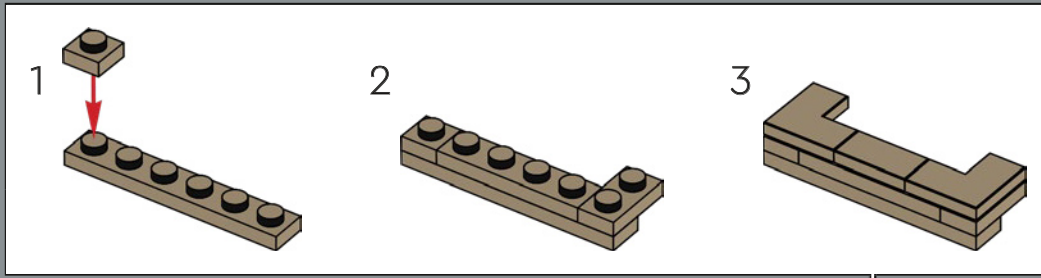

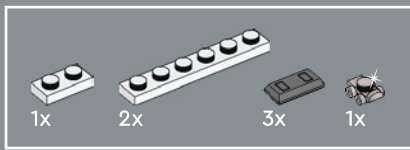

84

1

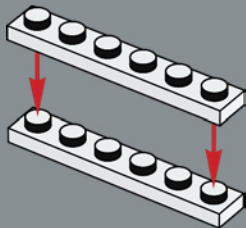

2

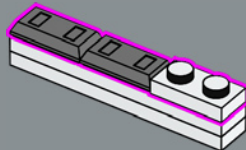

3

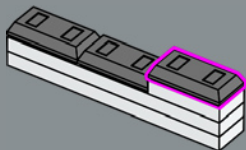

4



1:1

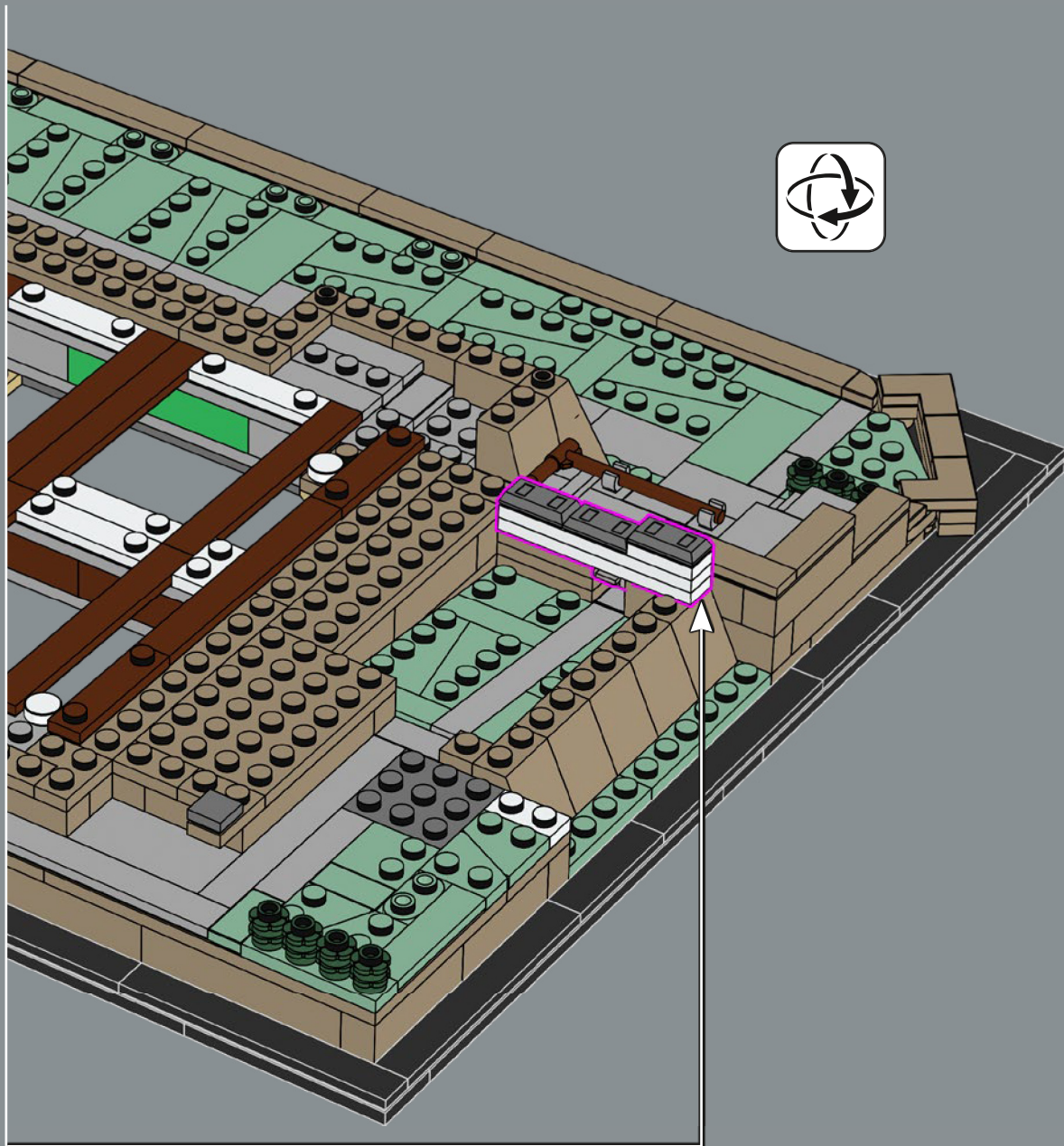

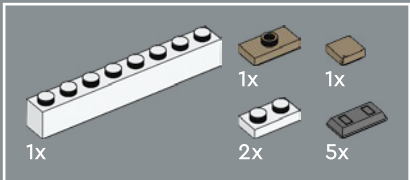

85

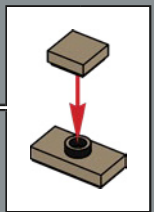
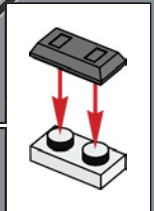
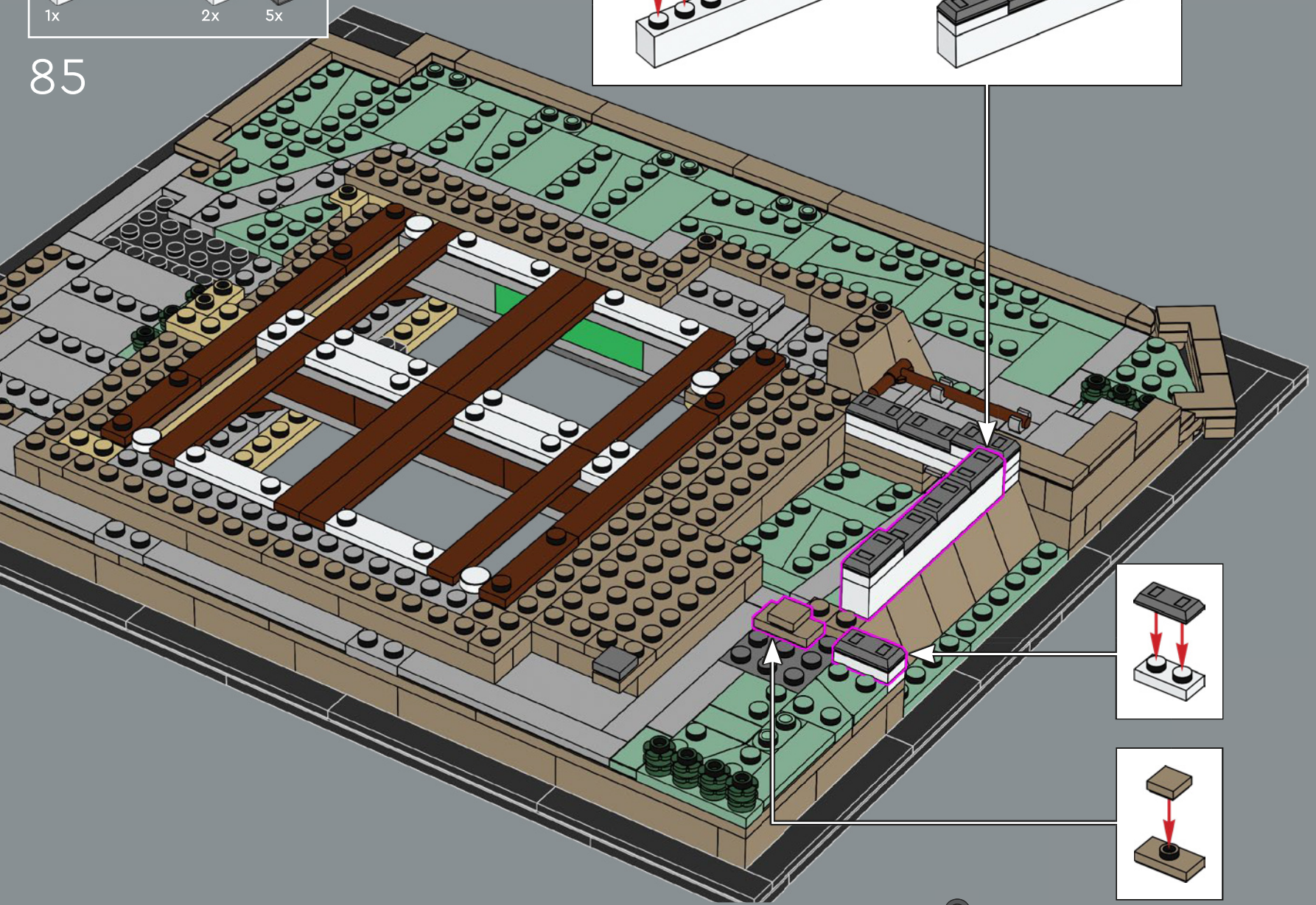
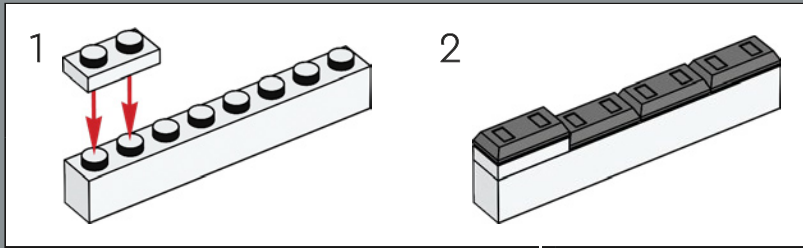

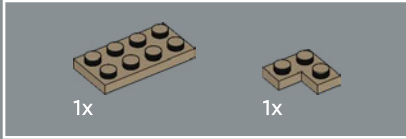
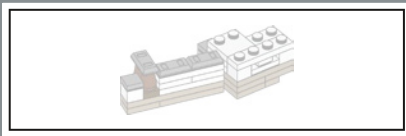

86

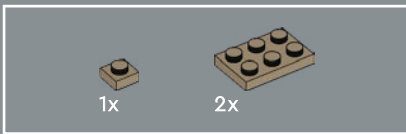
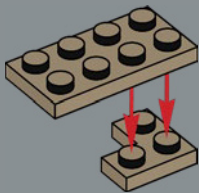

87

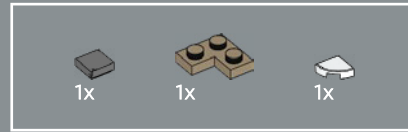
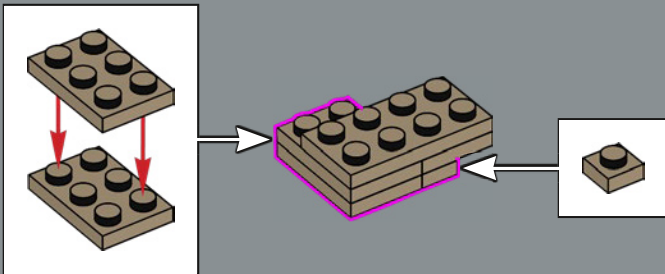

88

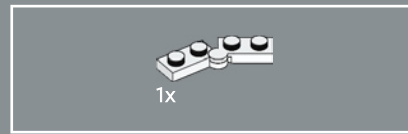
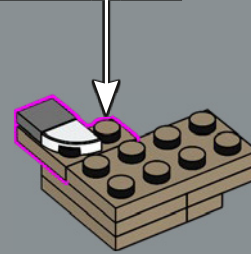
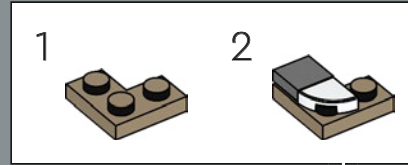

89

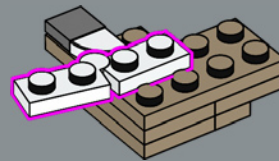

90

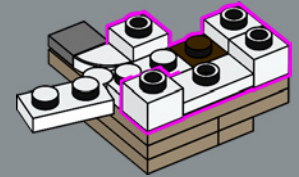

91

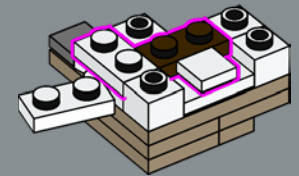

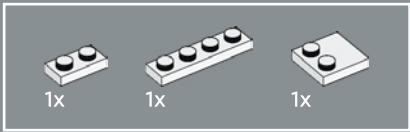

92

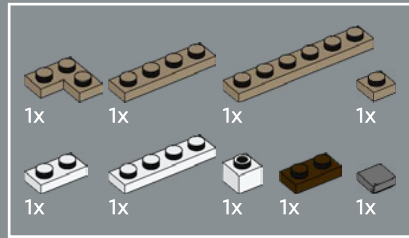
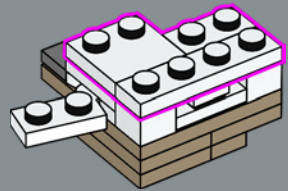

93

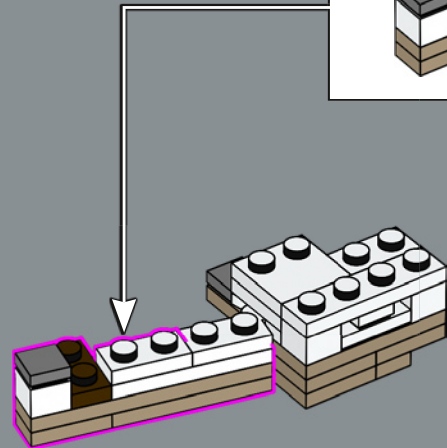
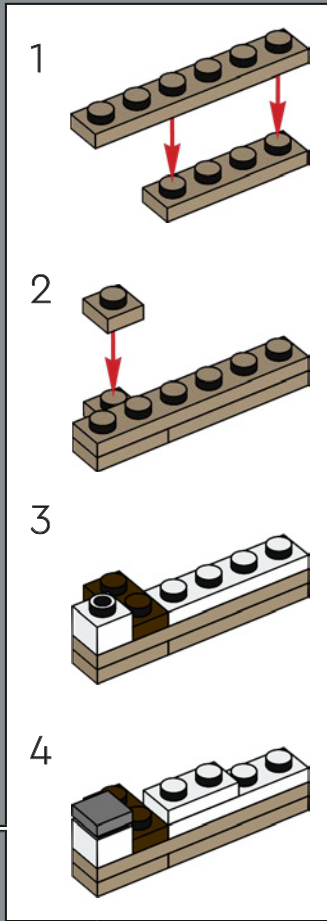

94

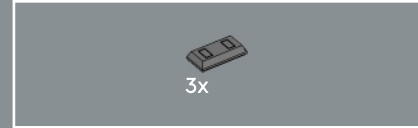
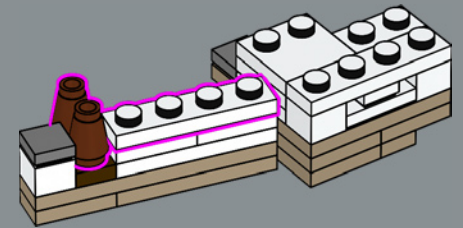

95

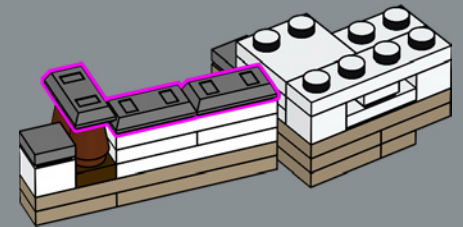

Una delle caratteristiche che rendono l'architettura del castello così interessante è che molte delle mura, delle torri e dei percorsi sono disposti ad angoli irregolari.

96

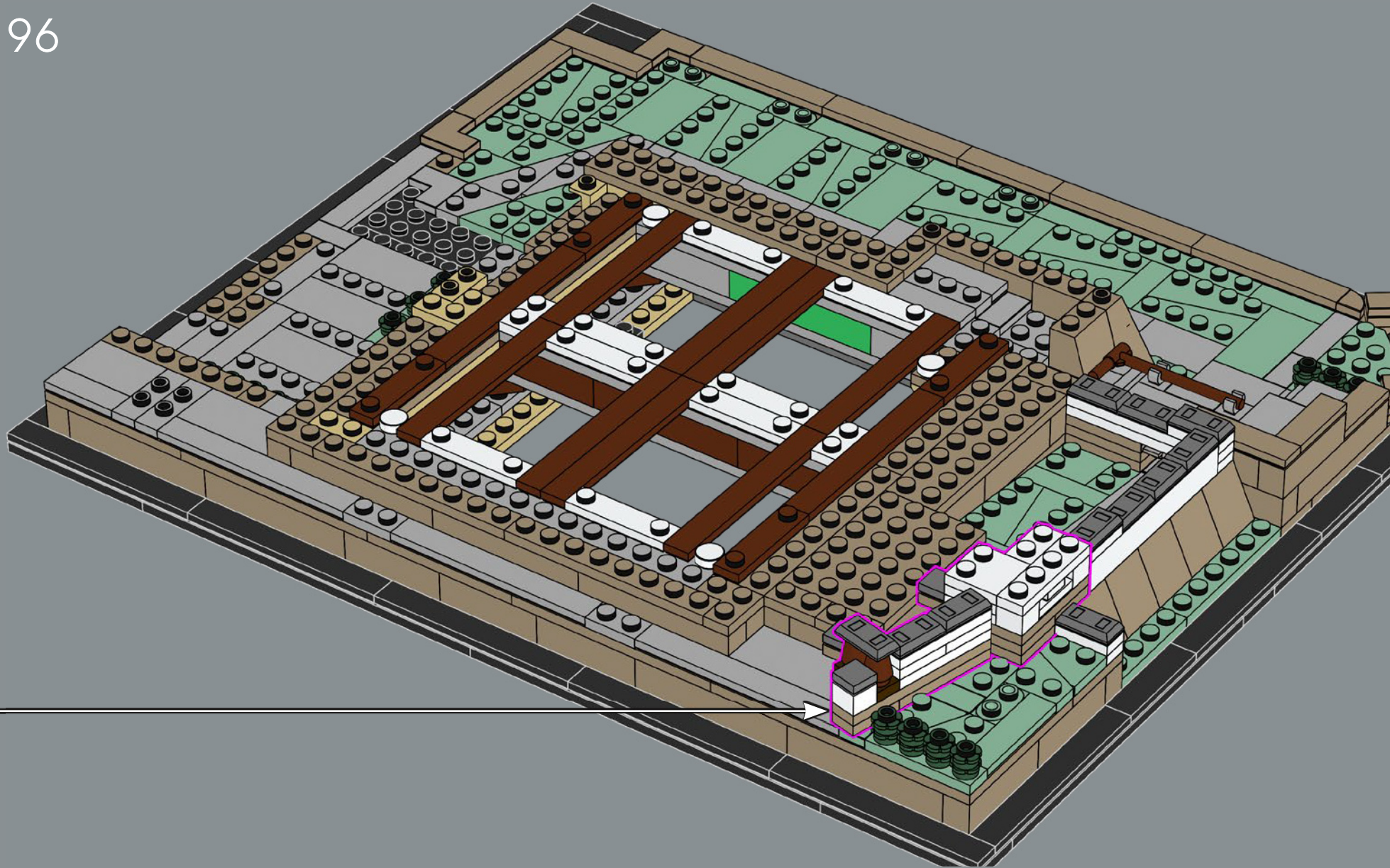

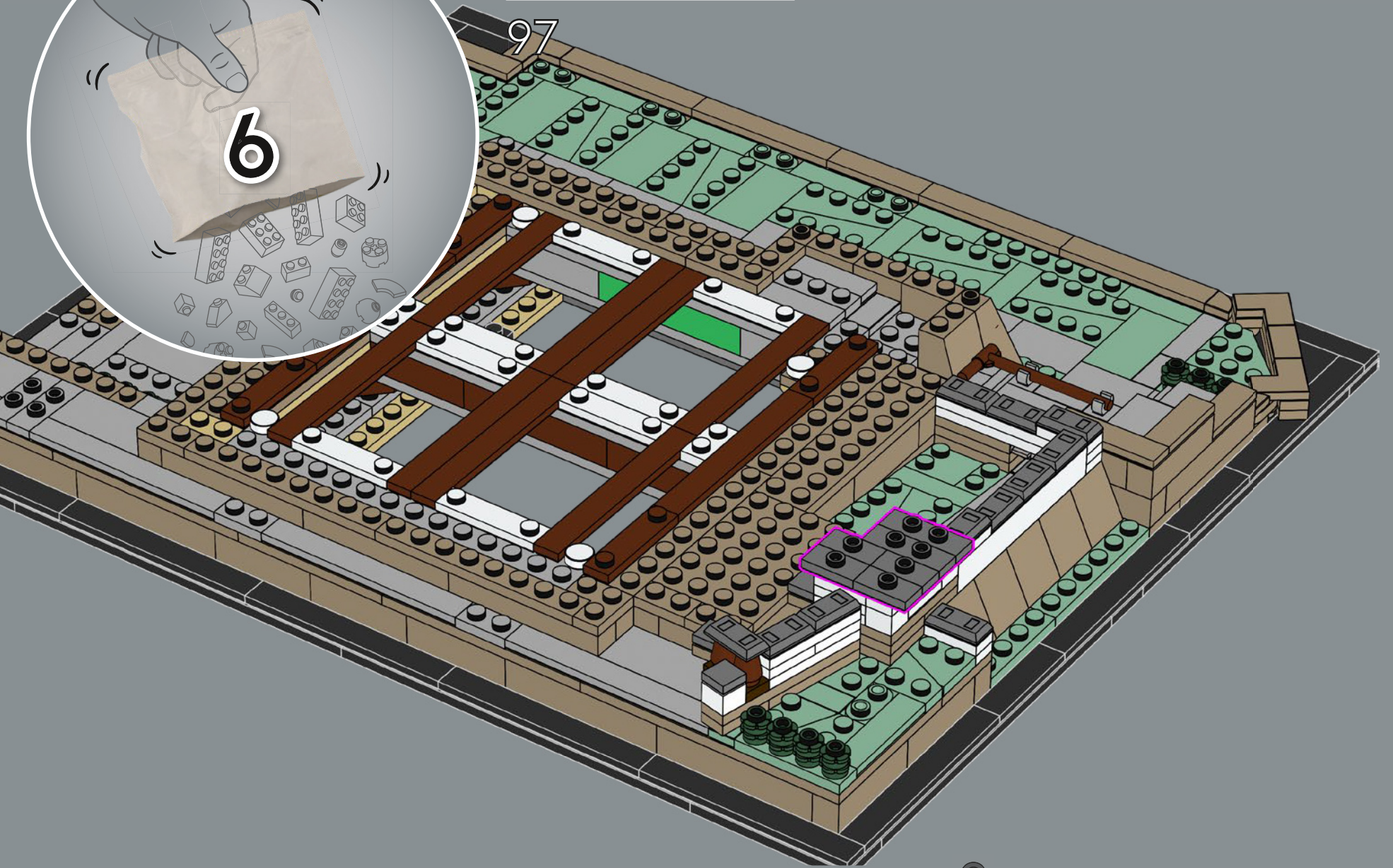
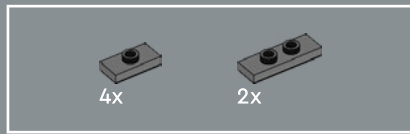

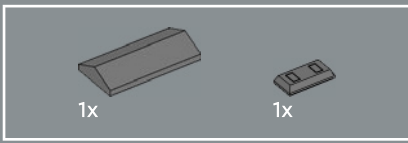

98

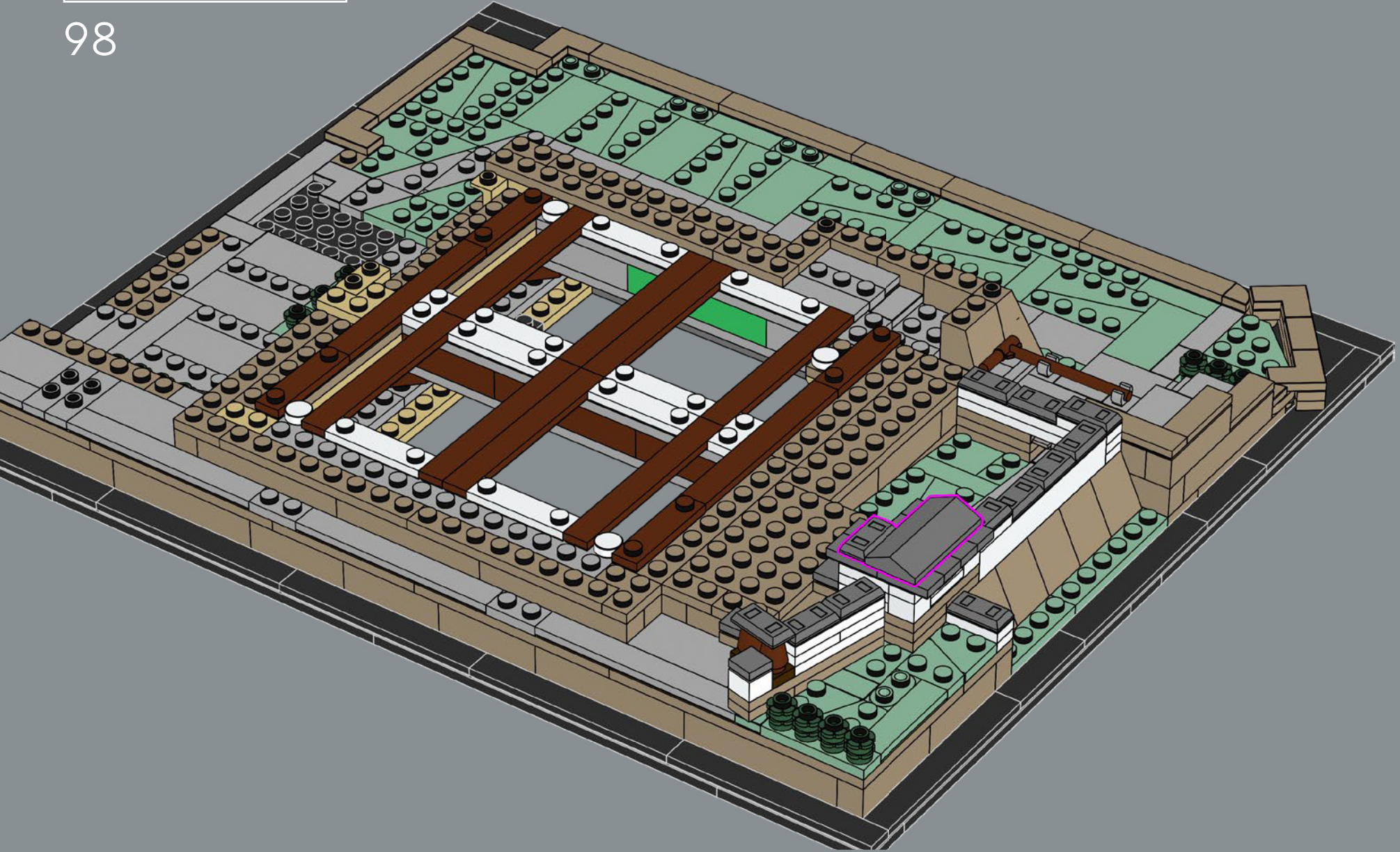

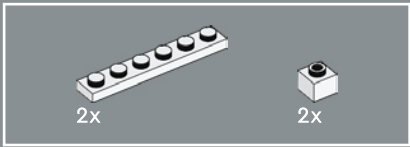

99

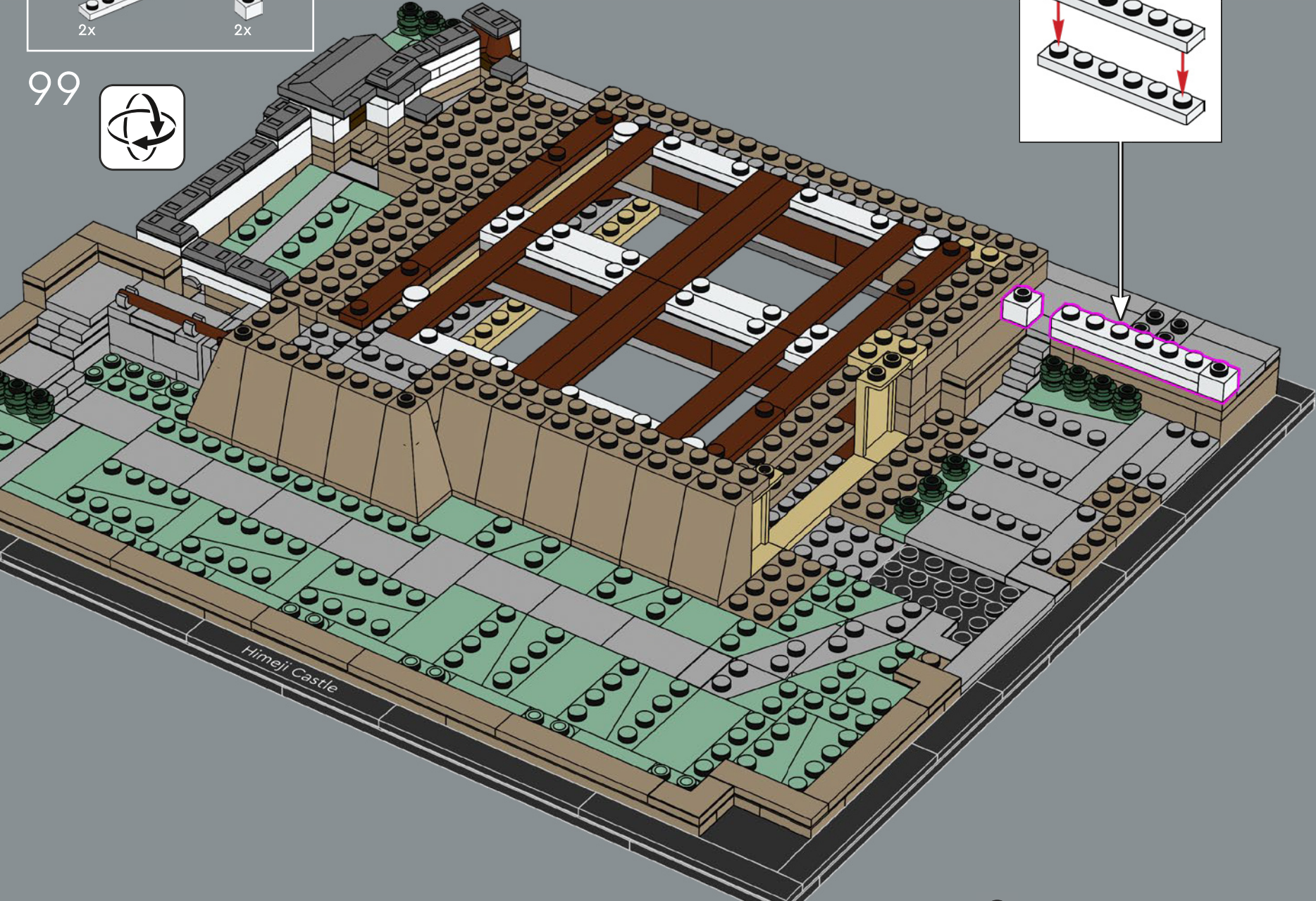
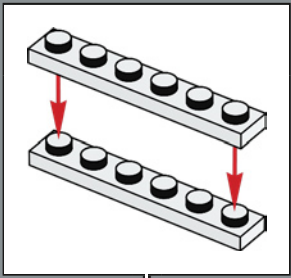

Himeji Castle



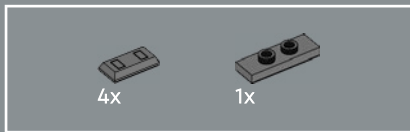

100

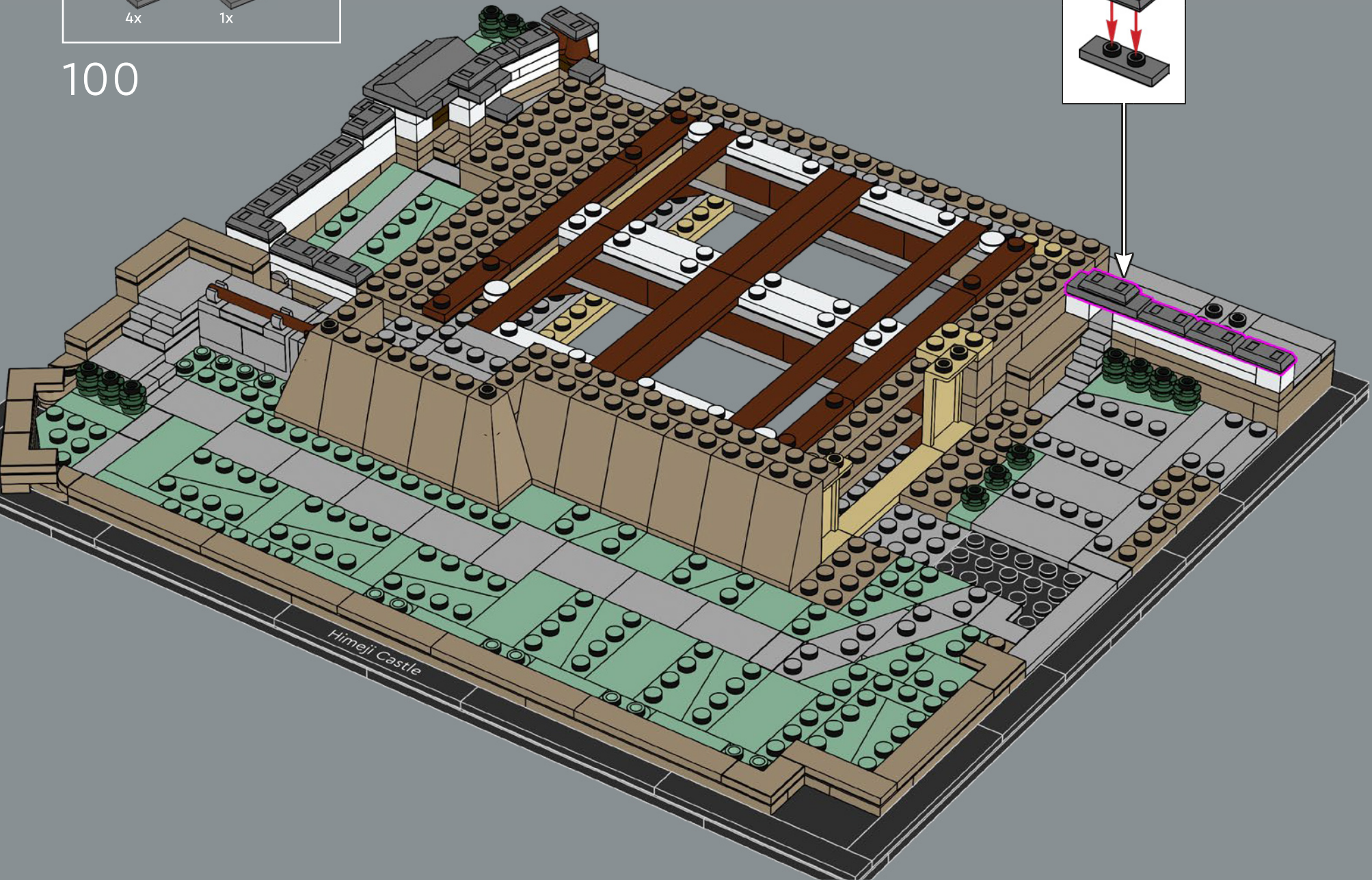
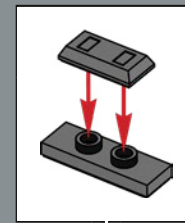

Himeji Castle

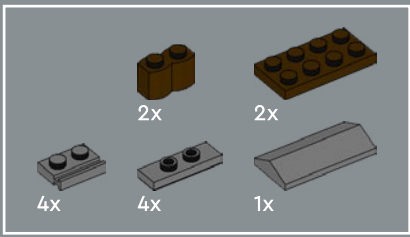

101

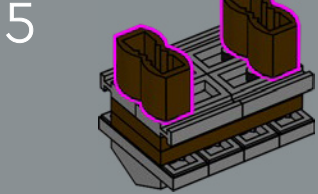
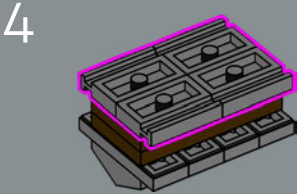
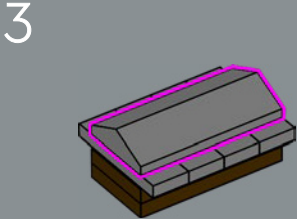
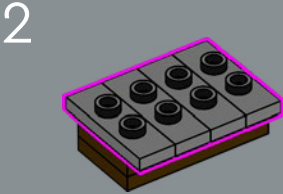
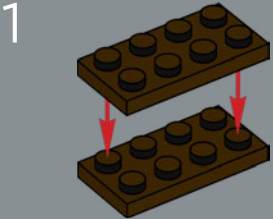

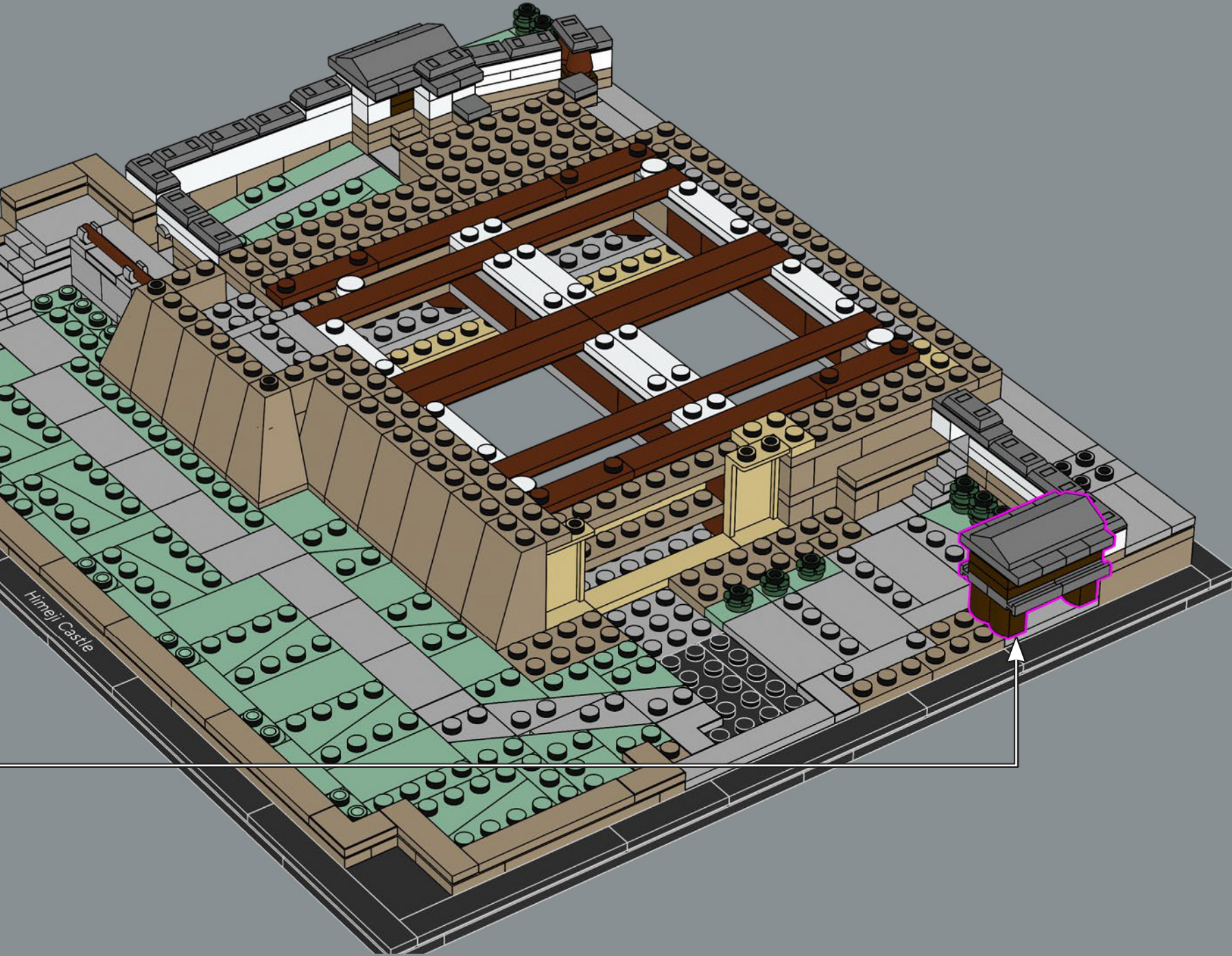

Himeji Castle

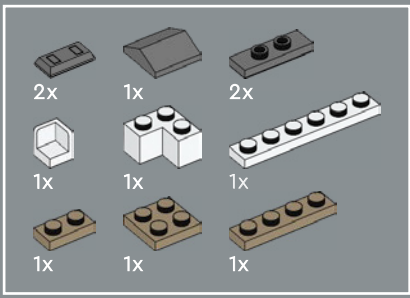

102

1

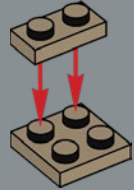

2

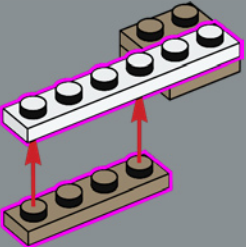

3

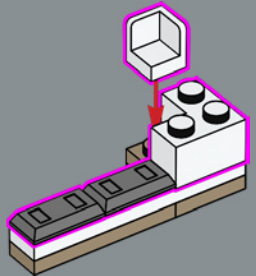

4

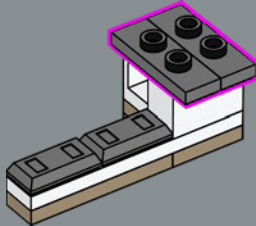

5

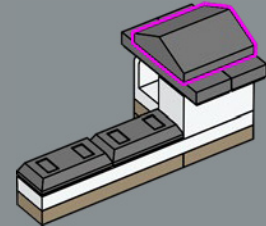

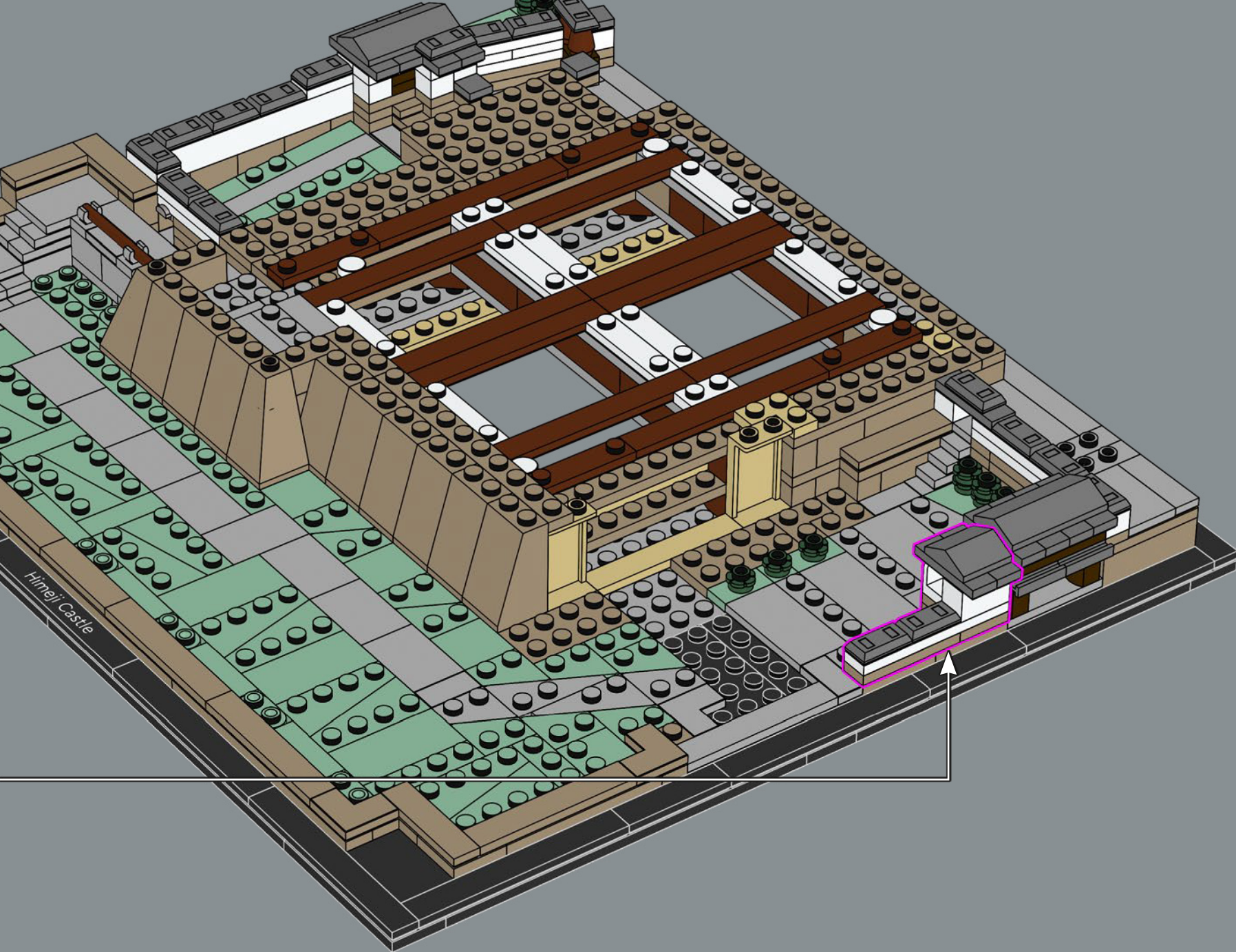

1x 2x 1x

103

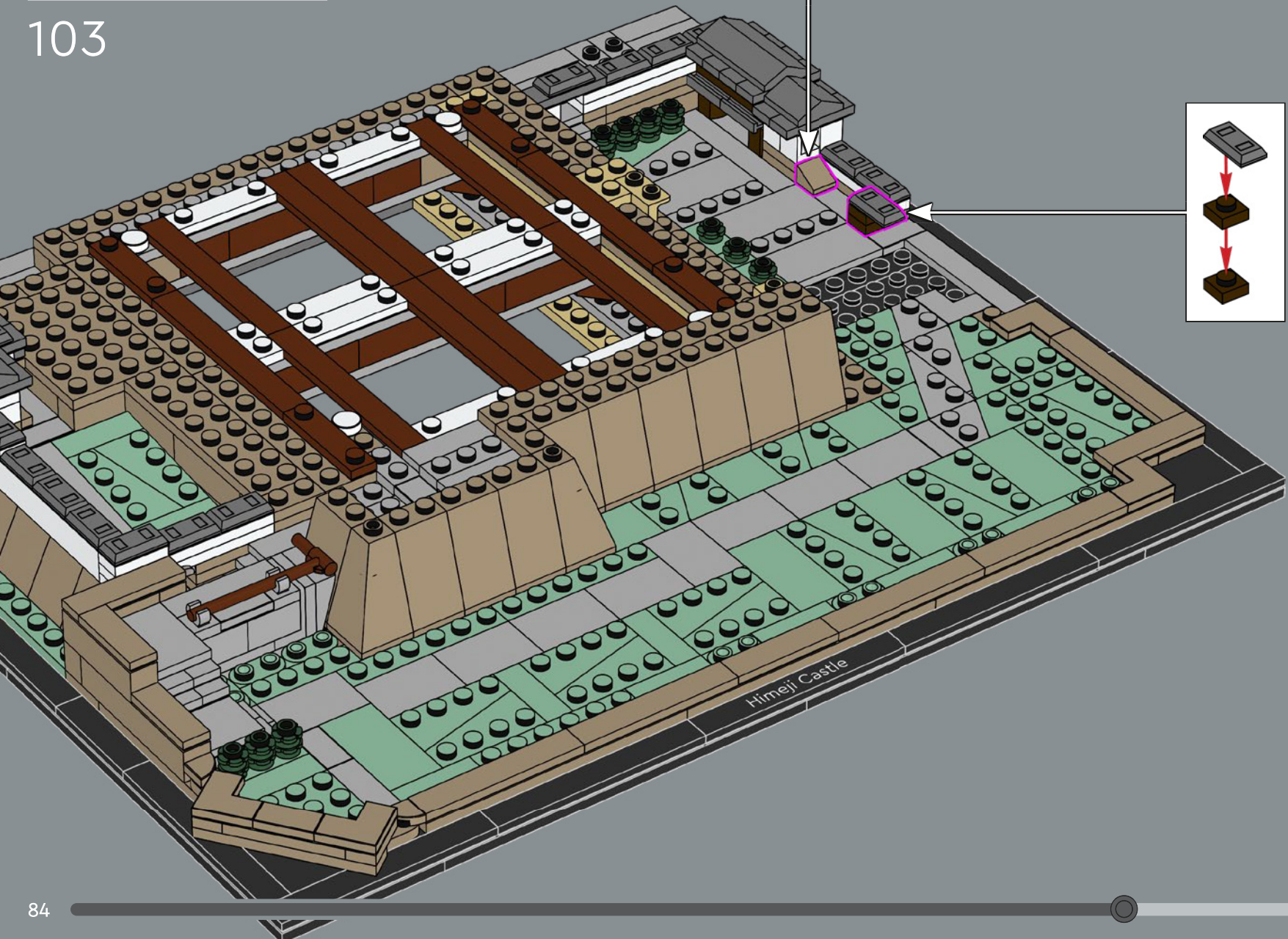
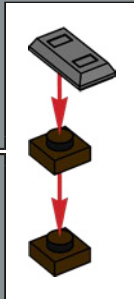

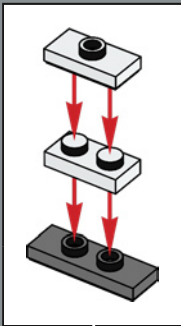
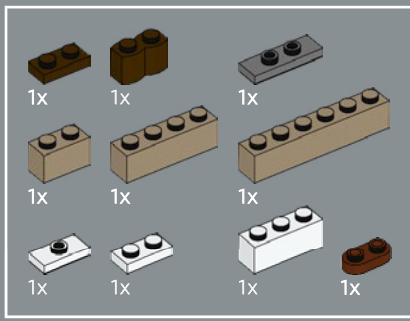

104

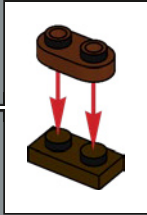
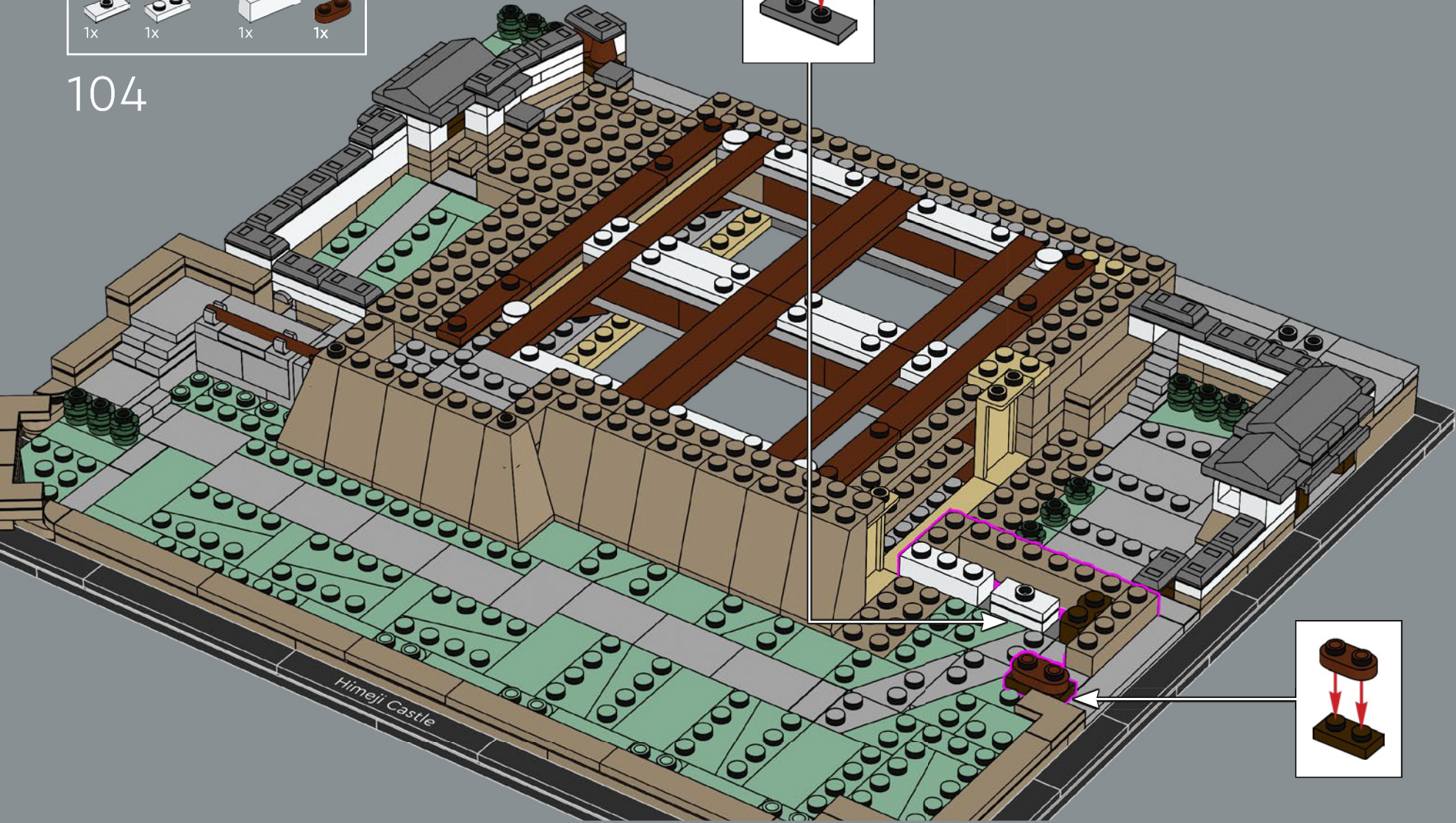

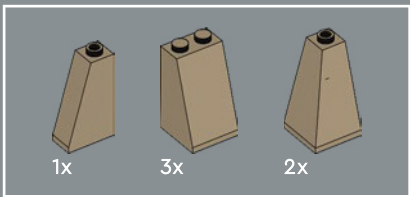

105

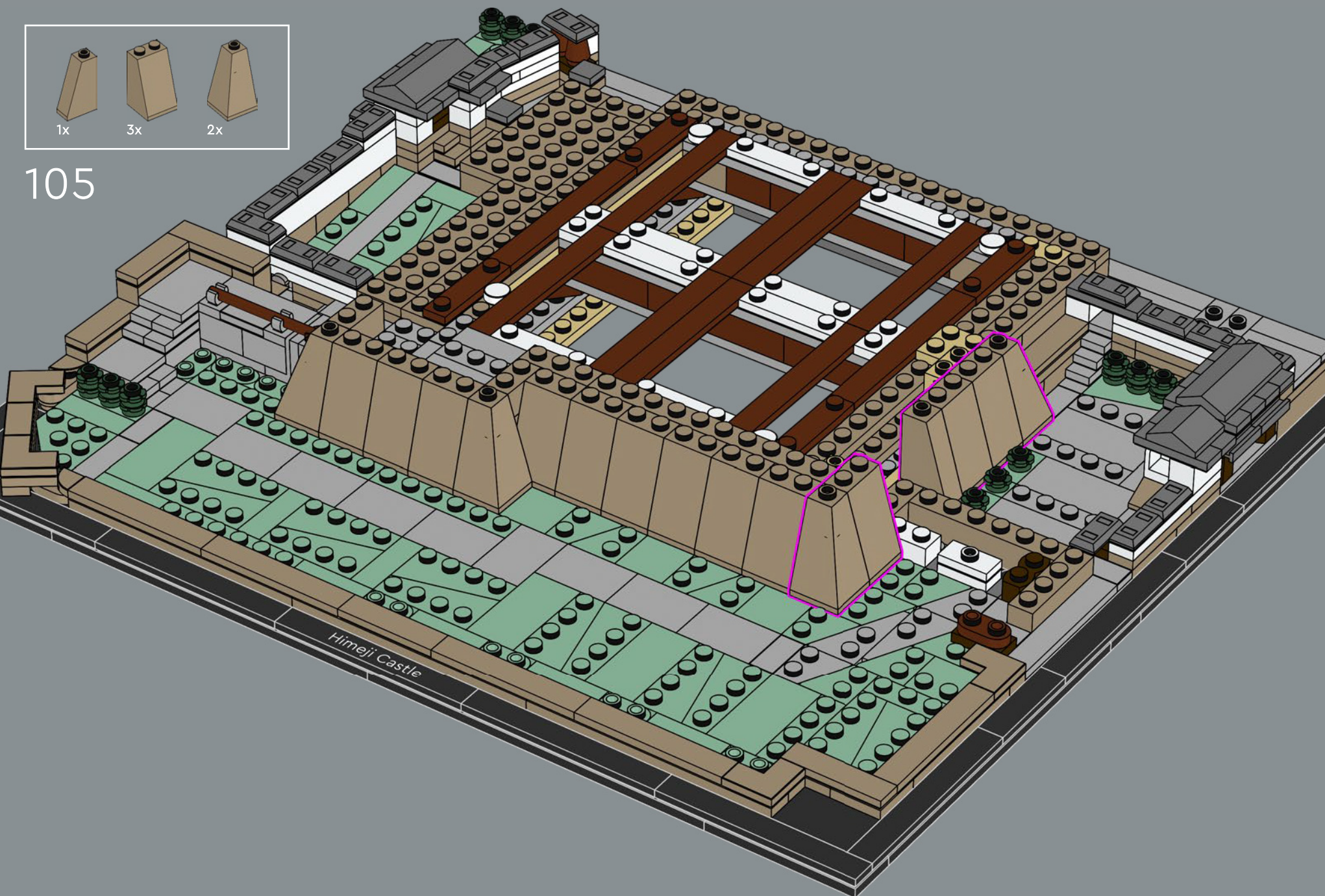

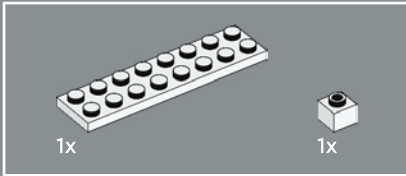
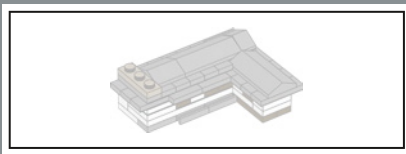

106

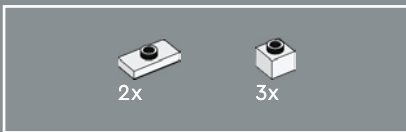
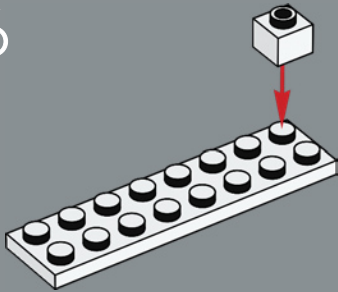

107

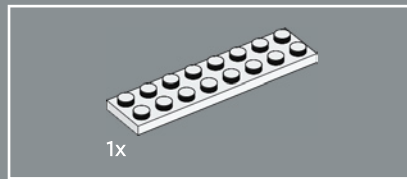
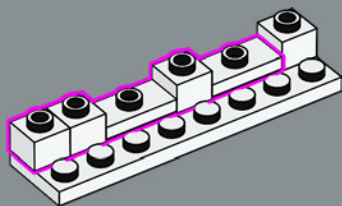

108

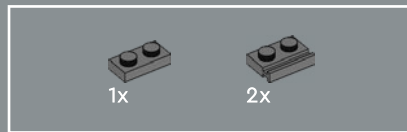
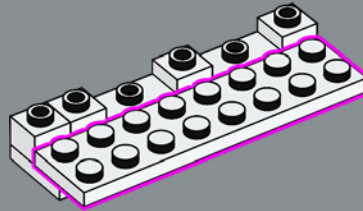

109

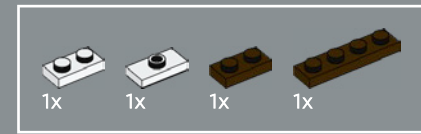
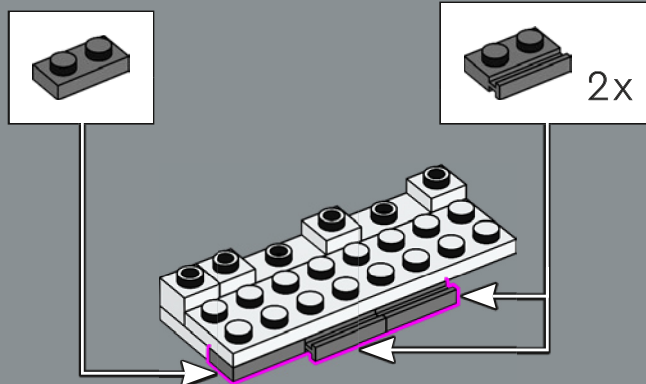

110

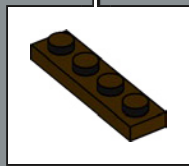
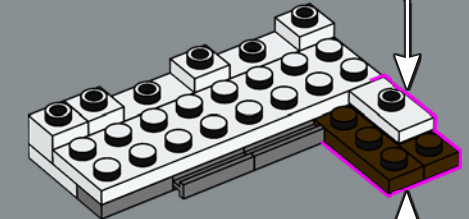
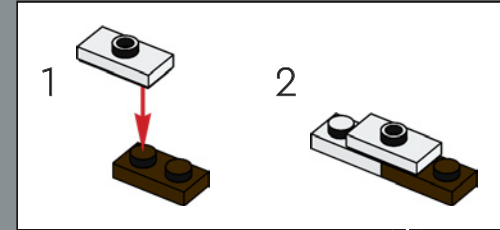

111

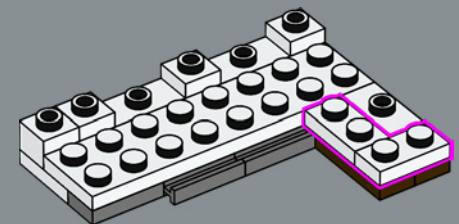

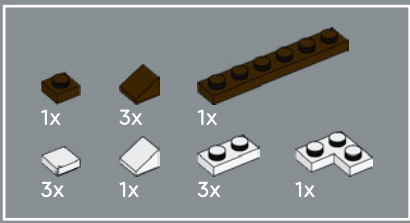

112

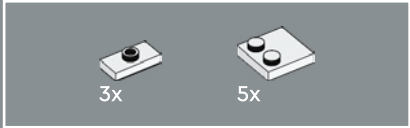
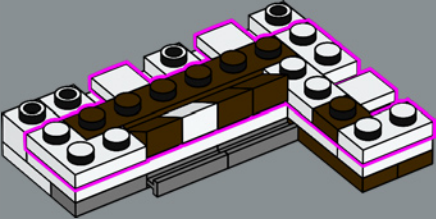

113

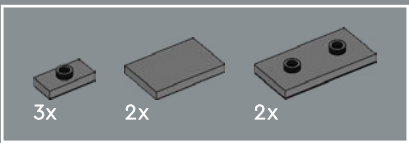
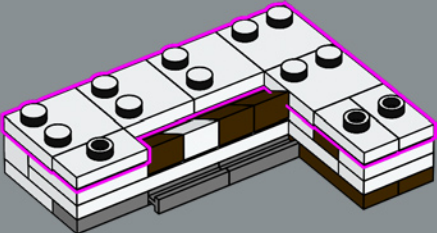

114

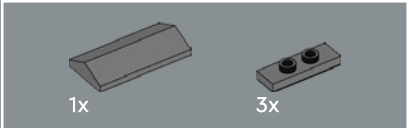
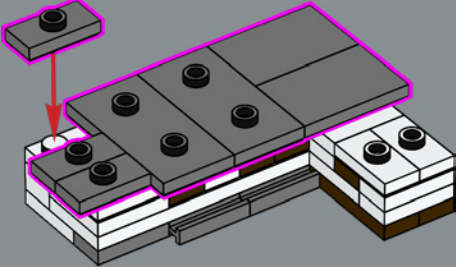

115

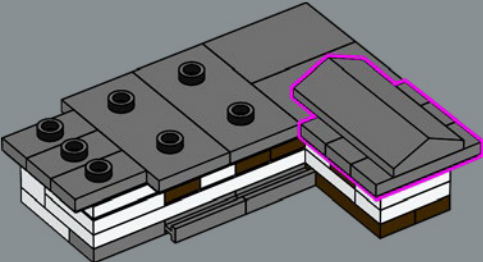
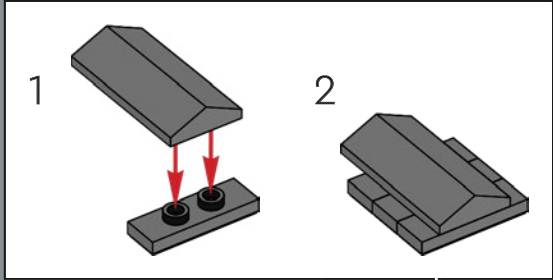

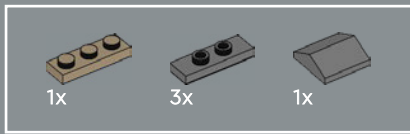

116

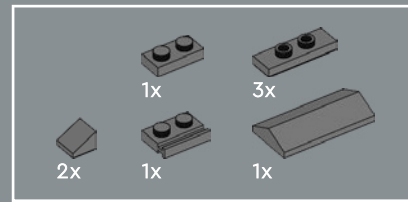
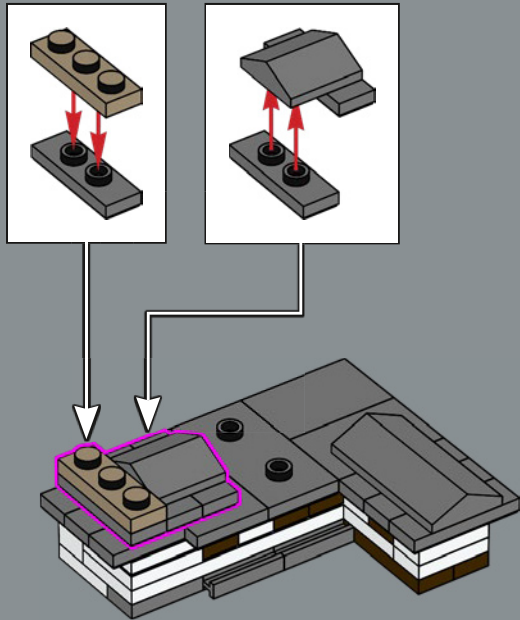

117

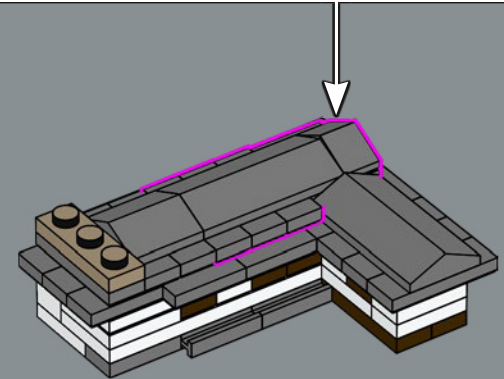
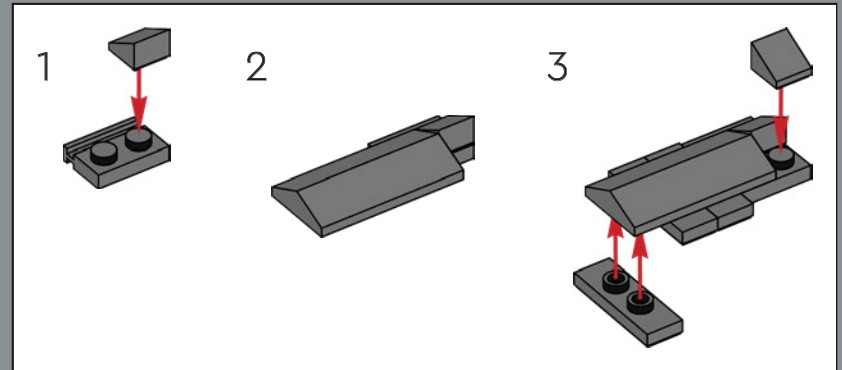

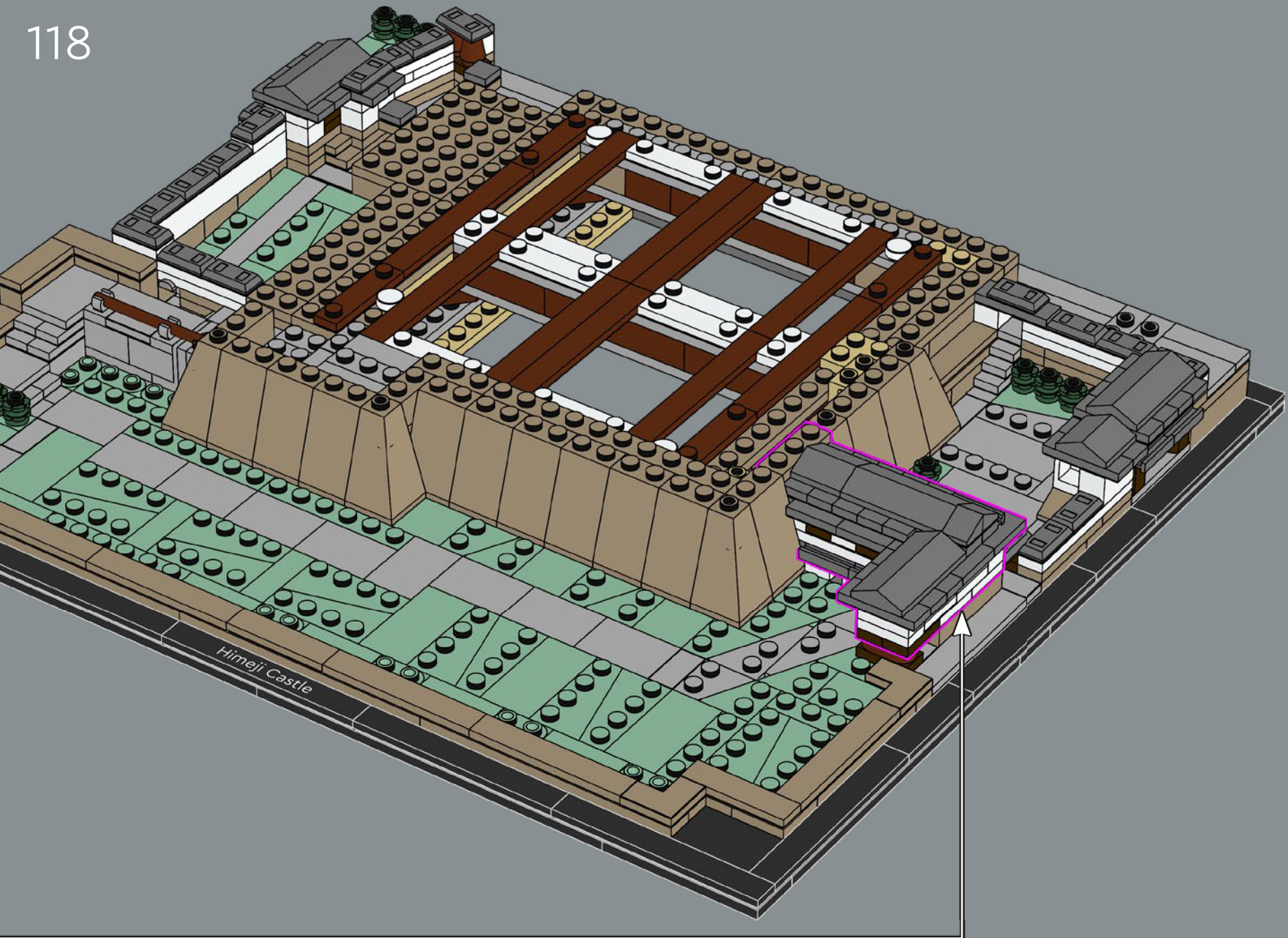

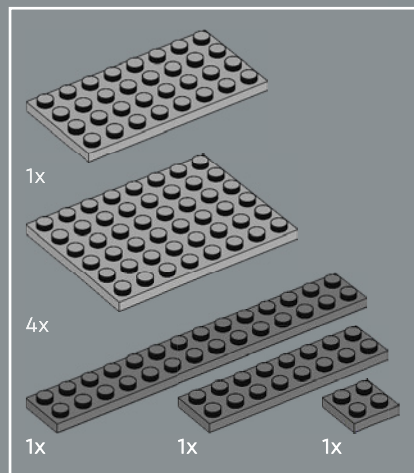

119

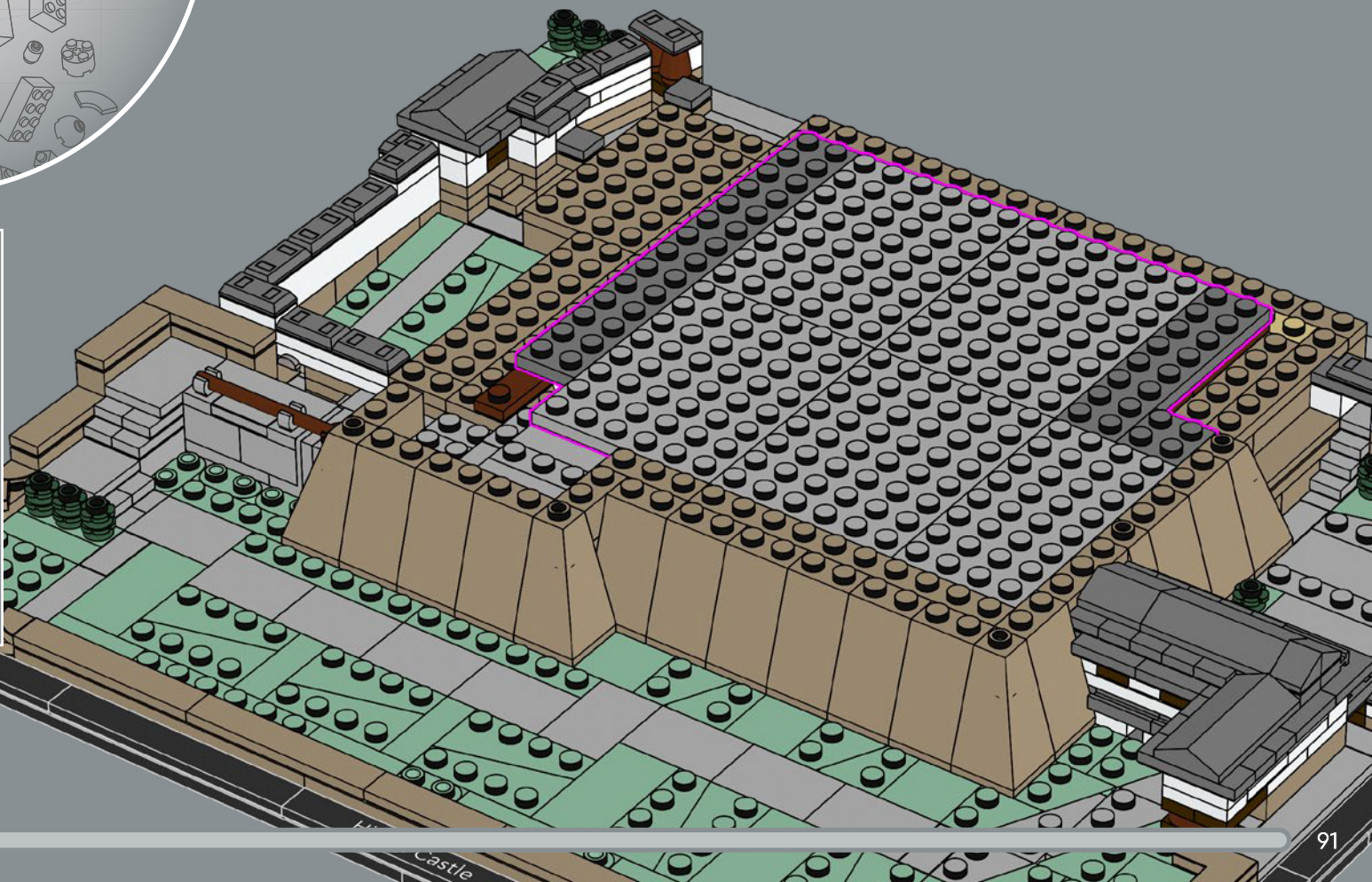

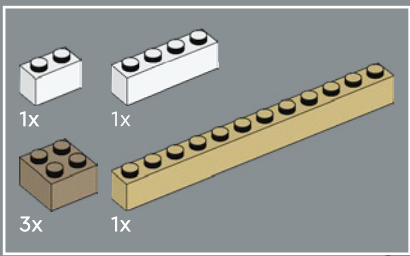

120

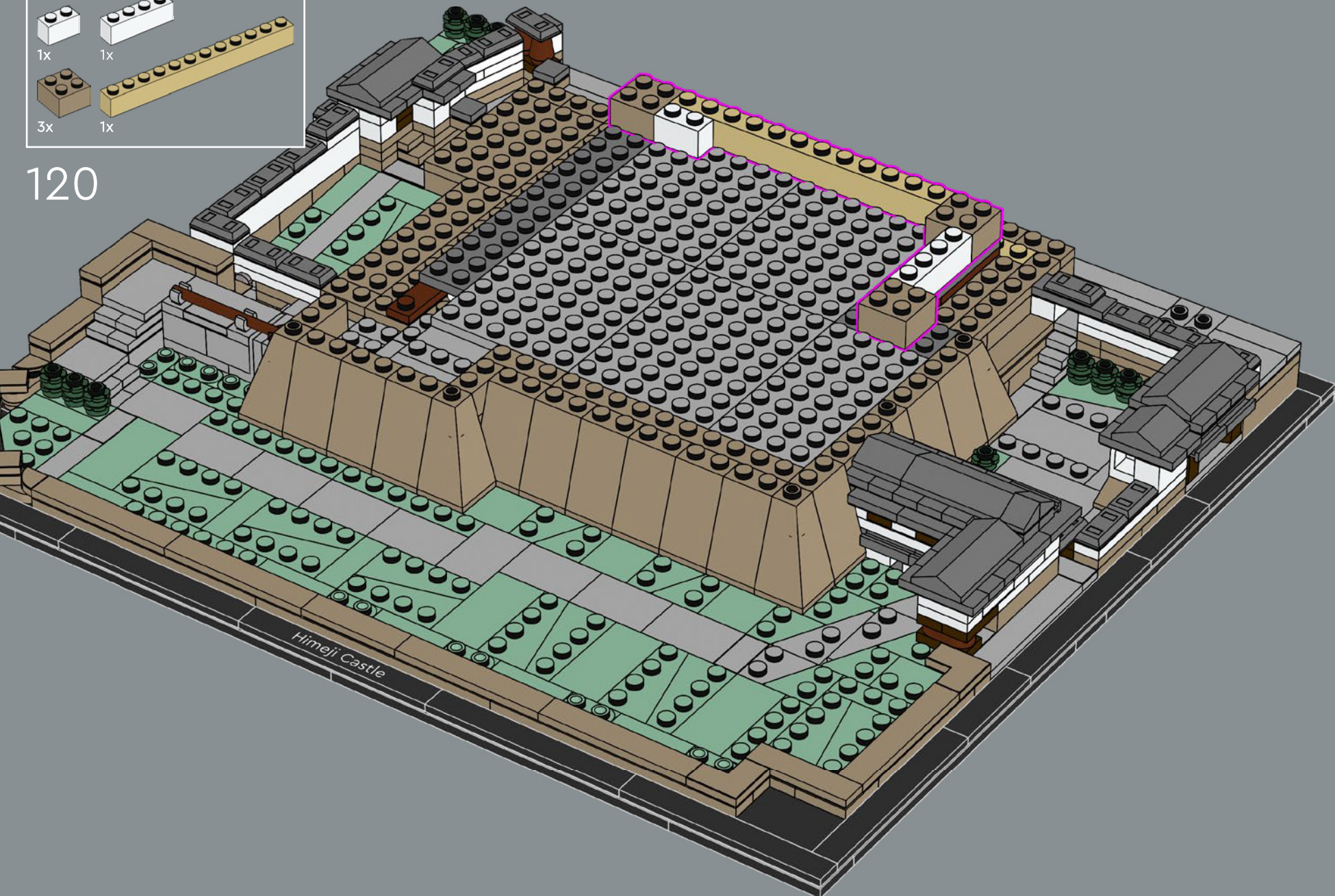

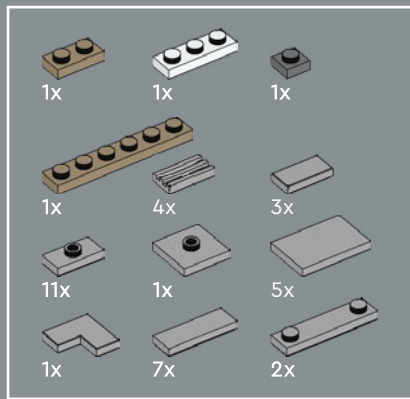

121

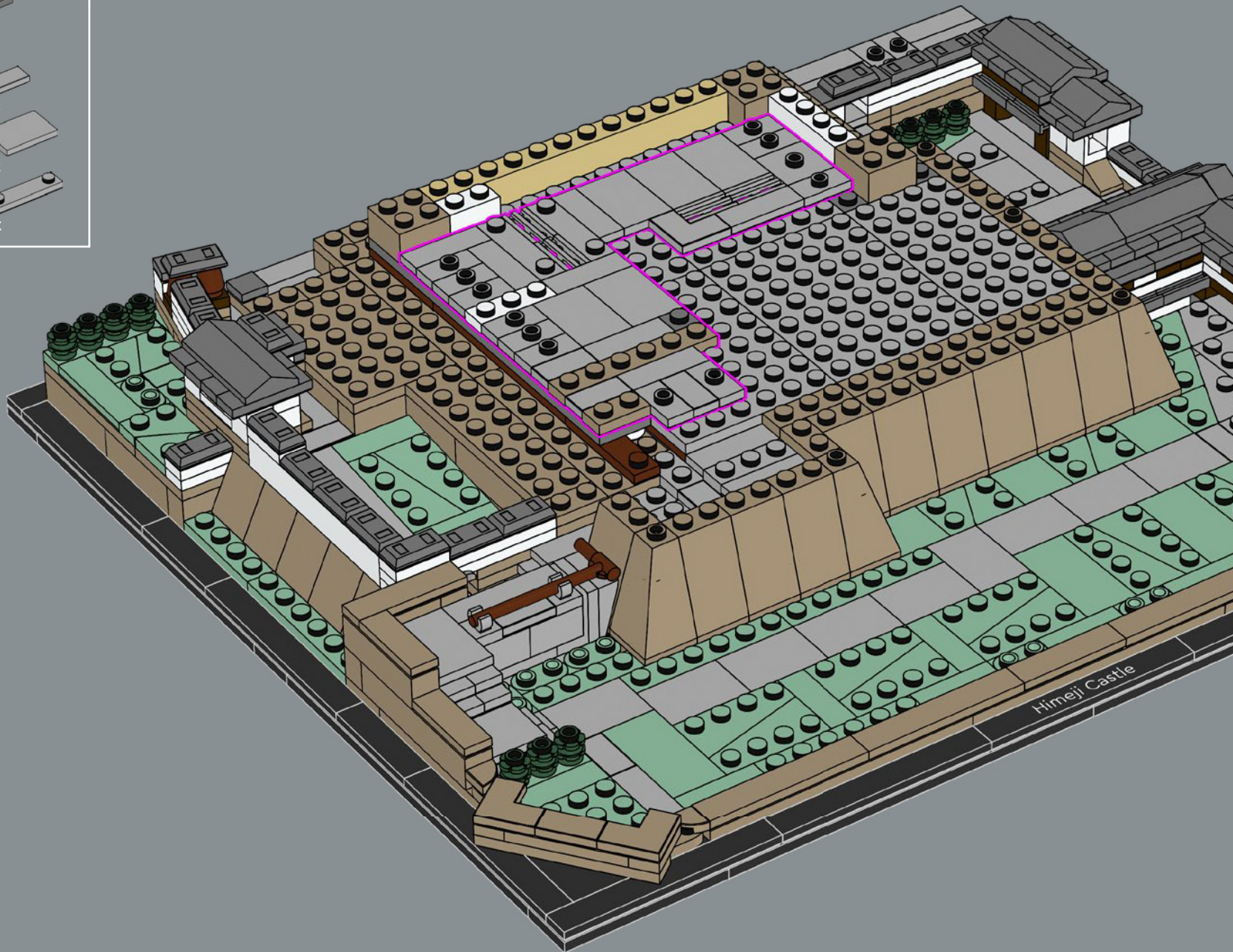

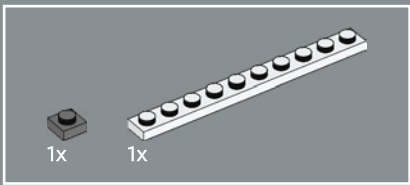

122

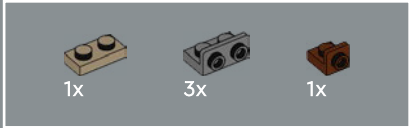
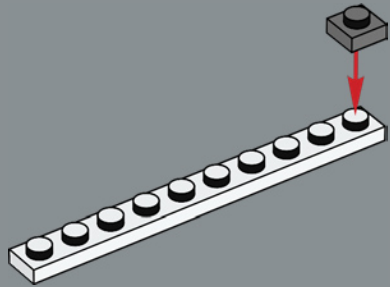

123

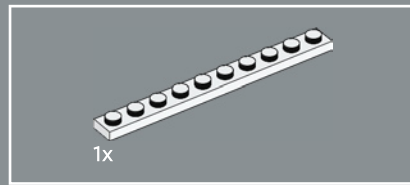
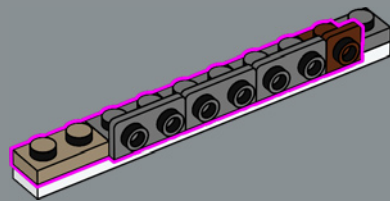

124

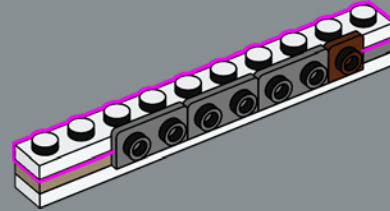

125

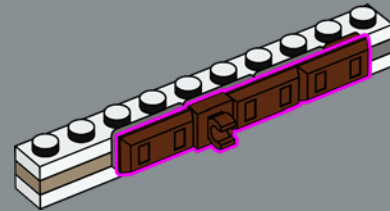

126

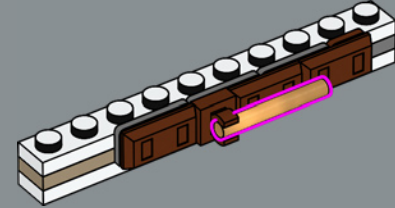

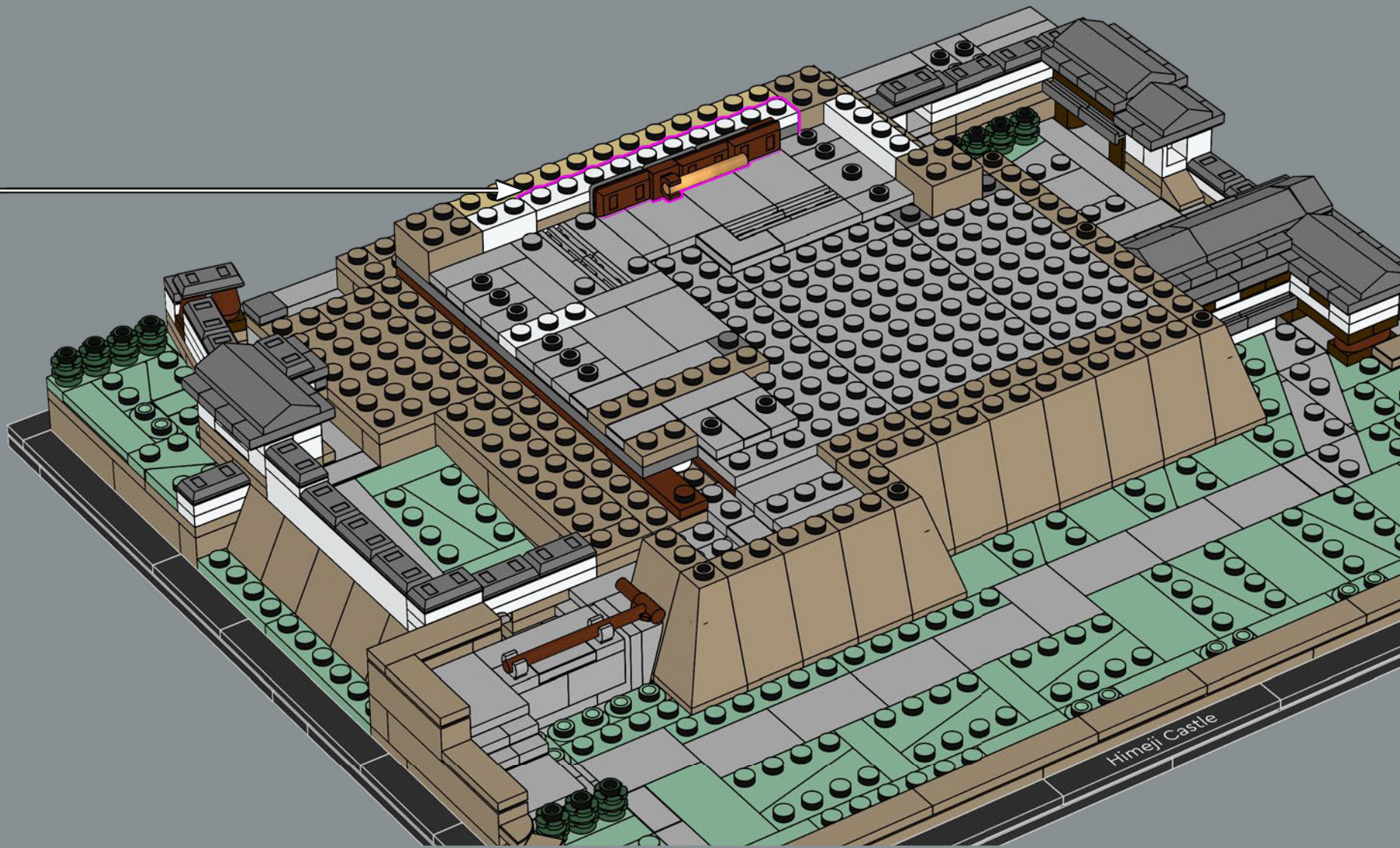

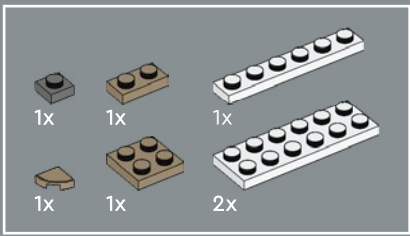

128

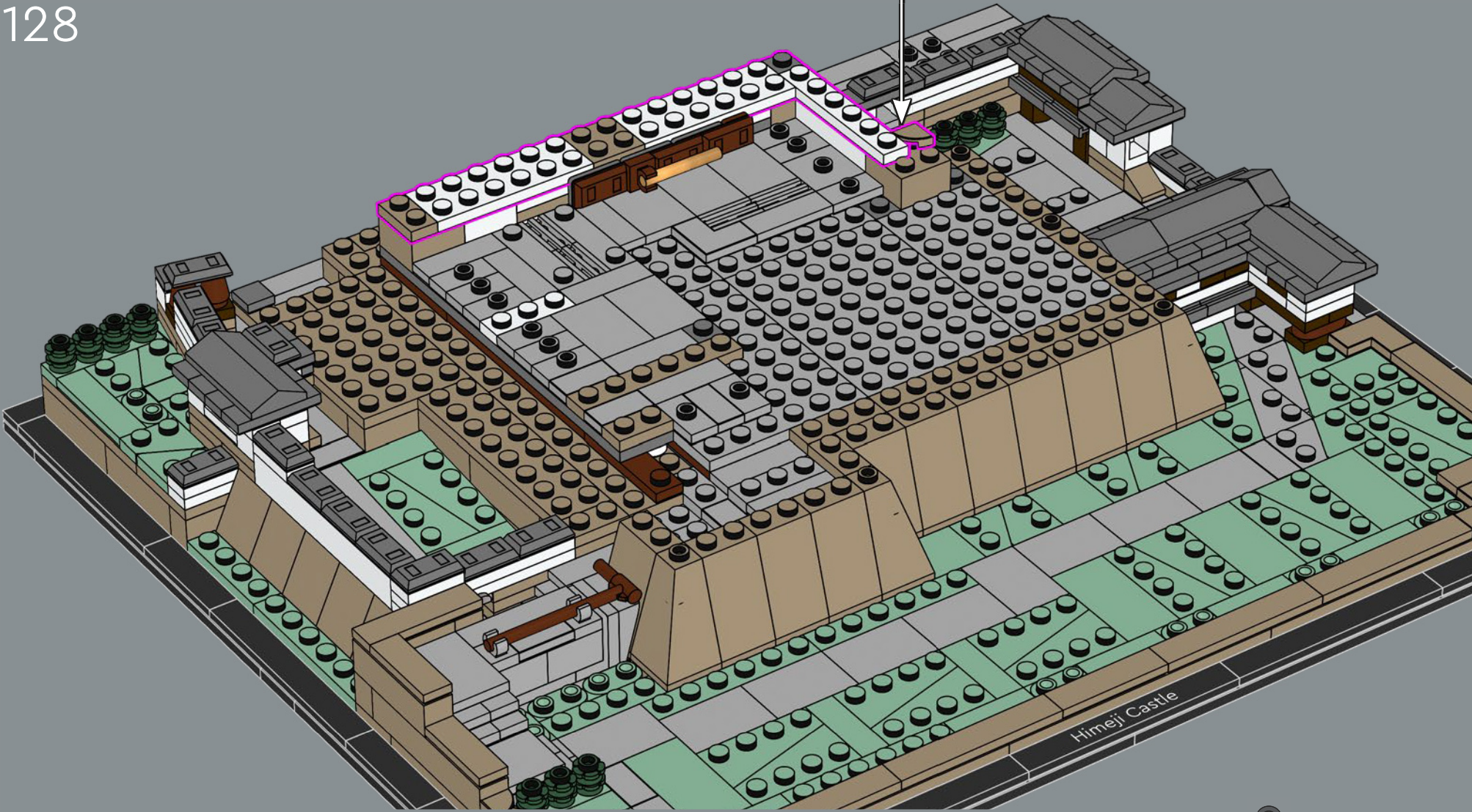

Himeji Castle

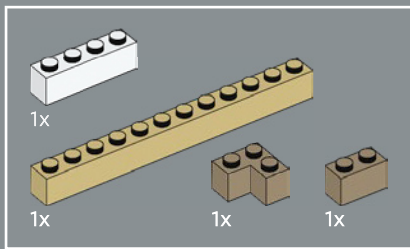

129

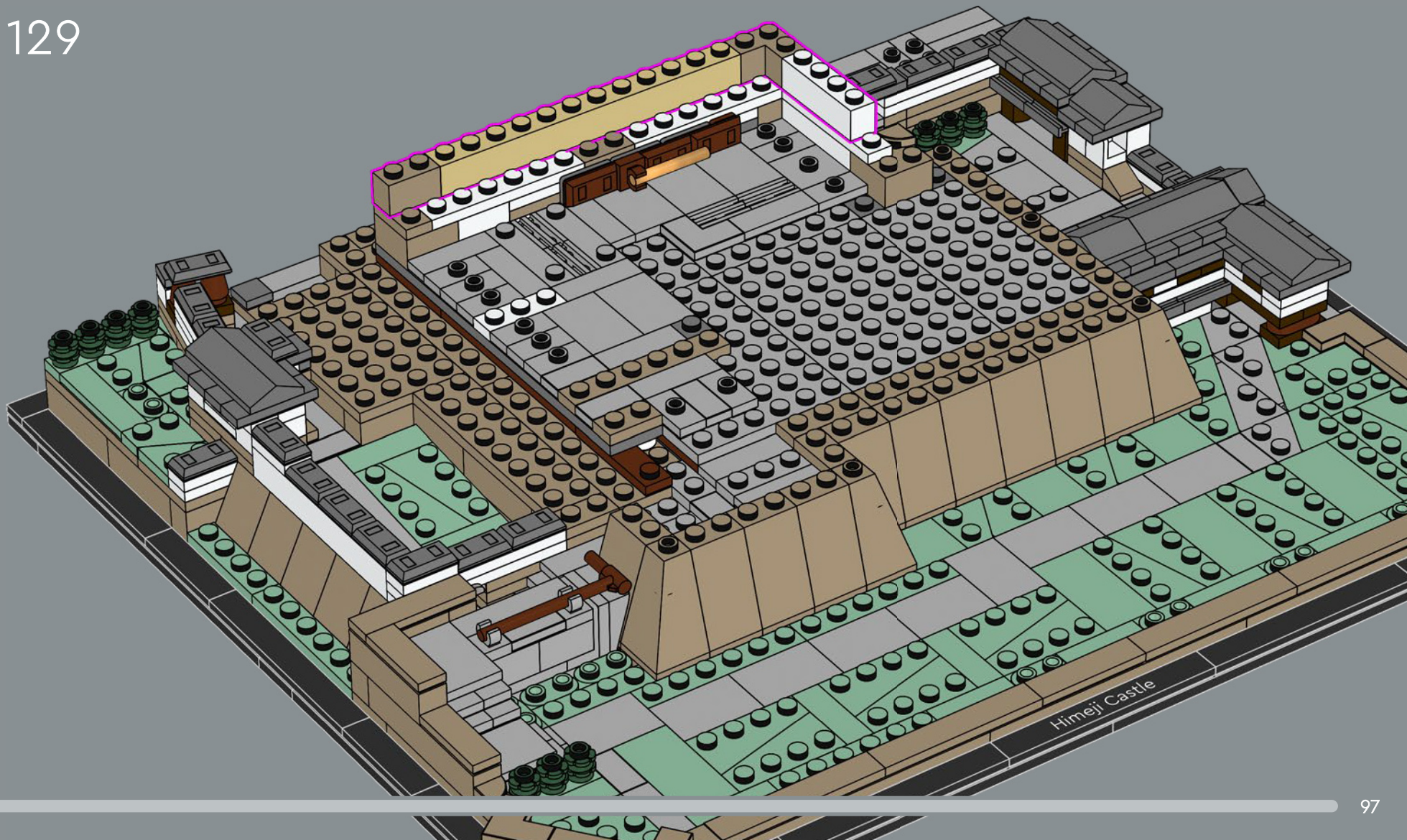

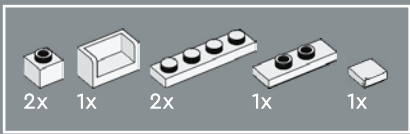

130

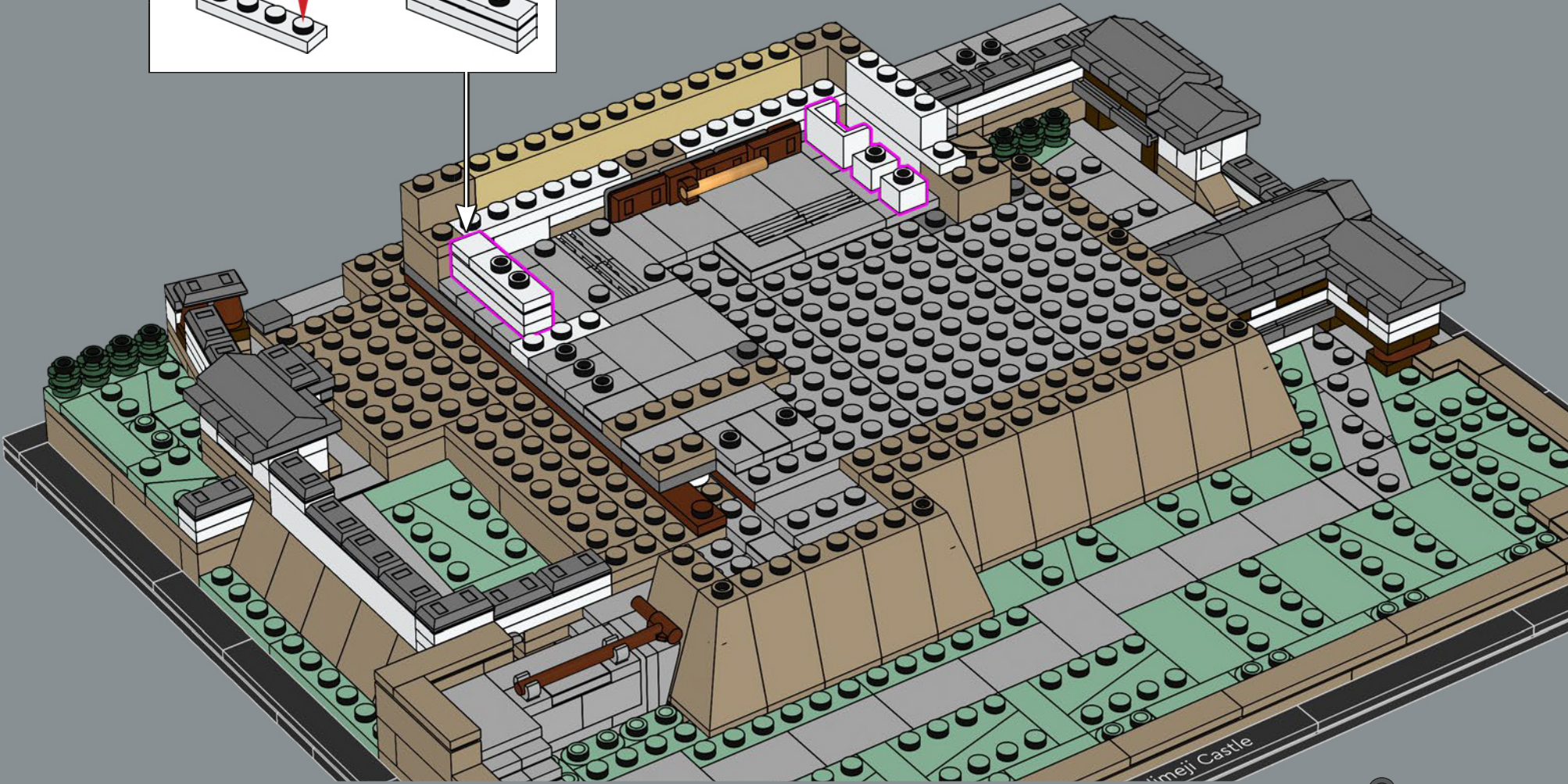
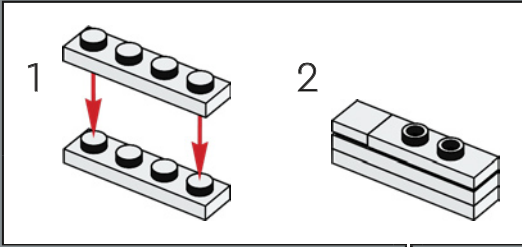

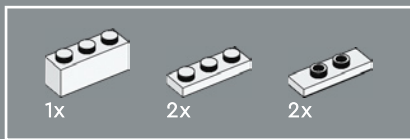

131

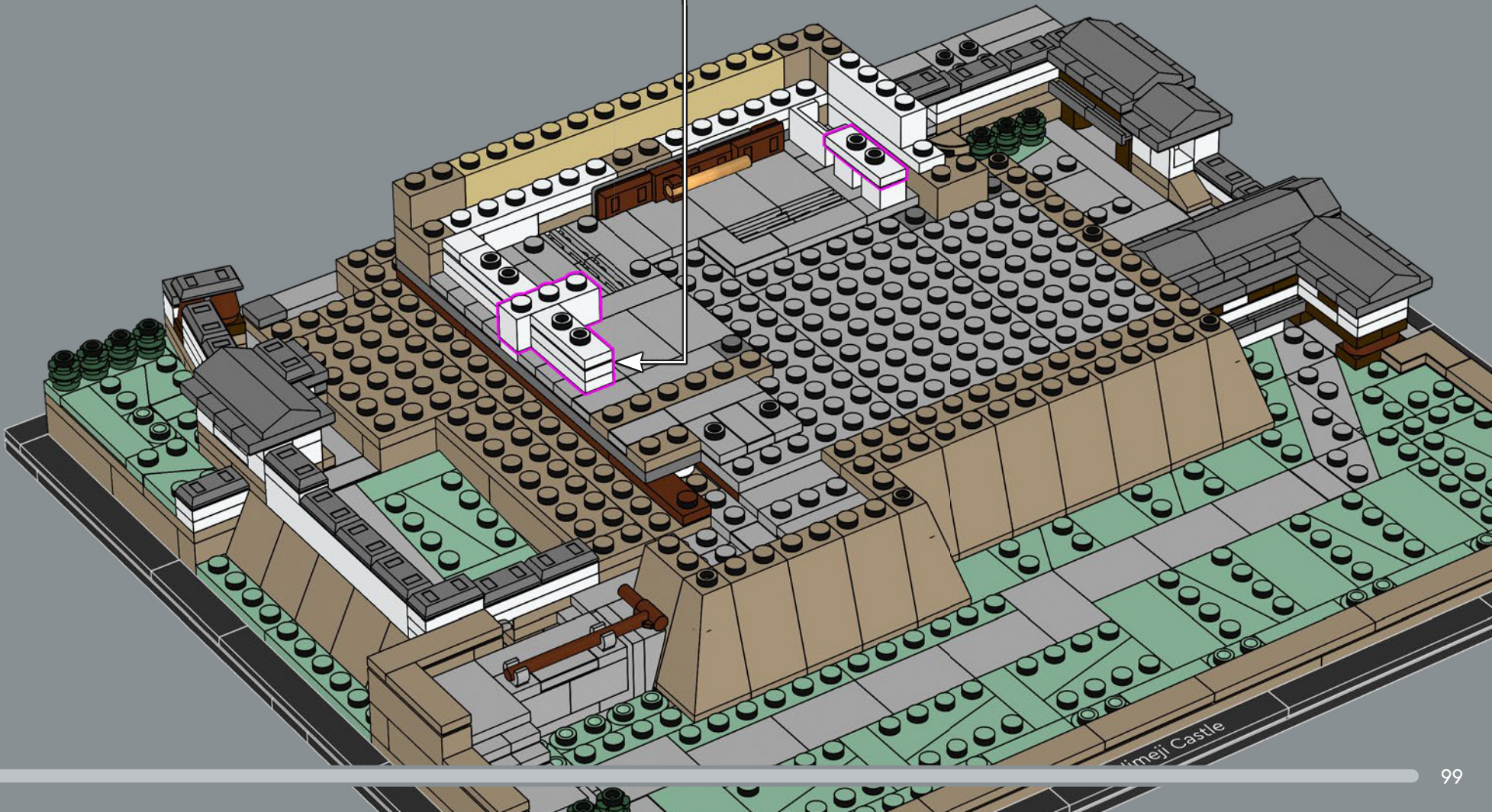
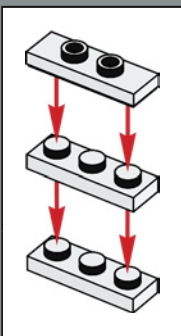

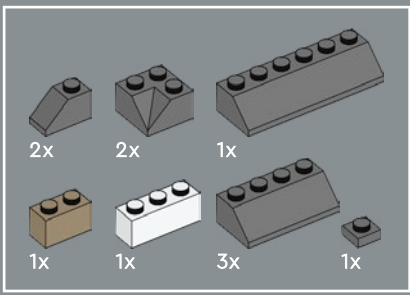

132

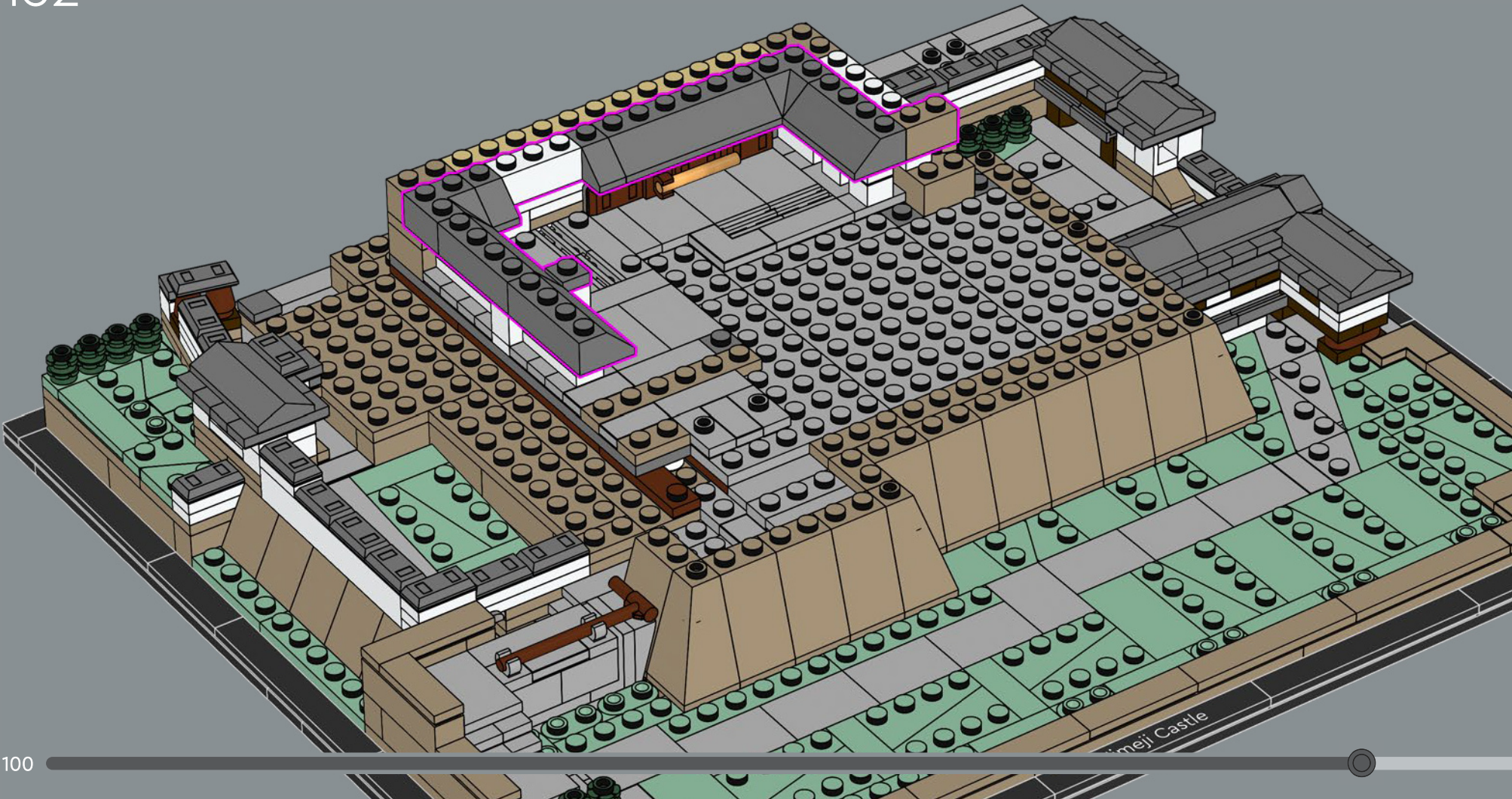

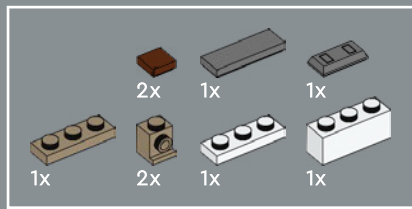

133

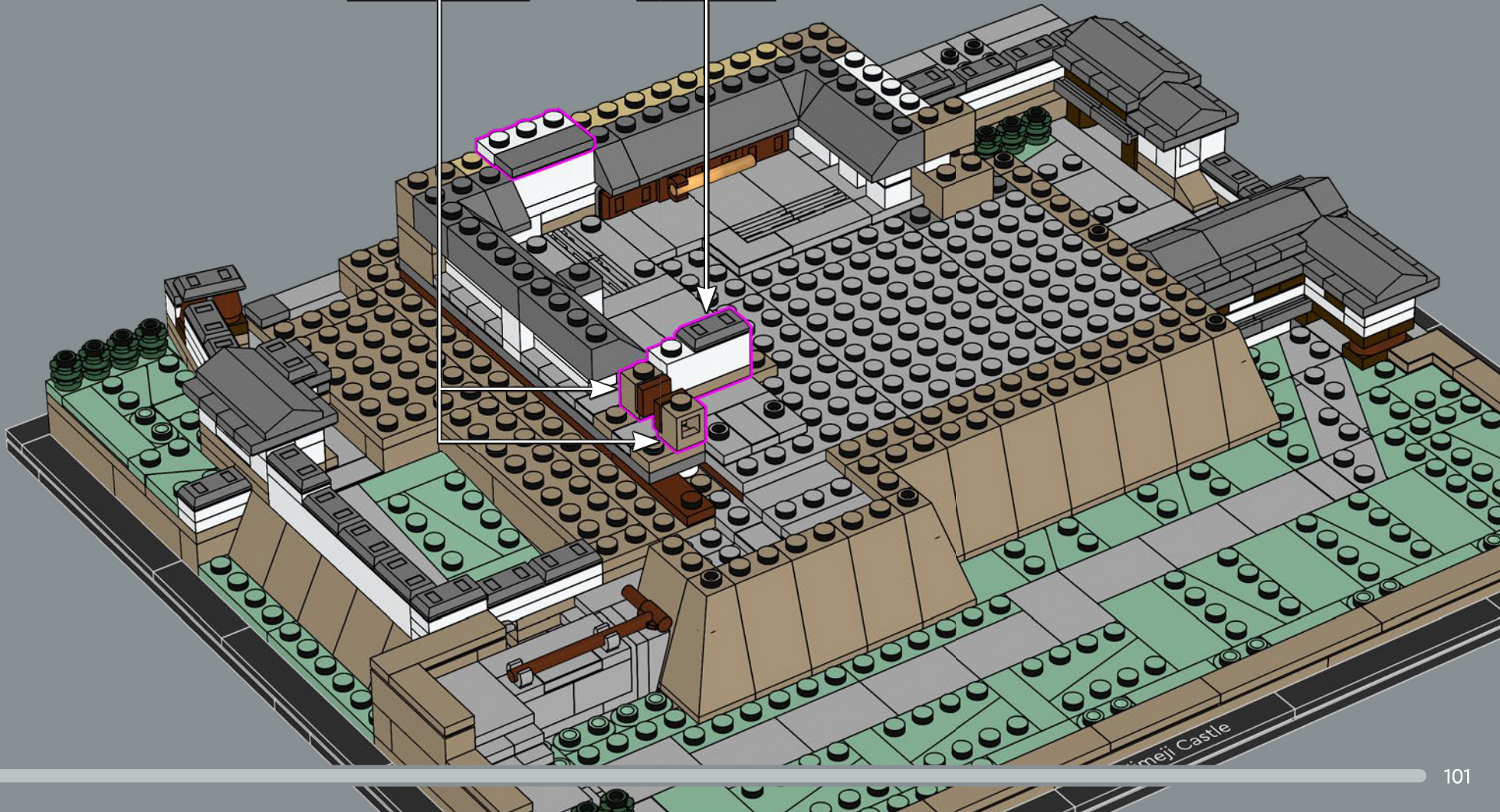
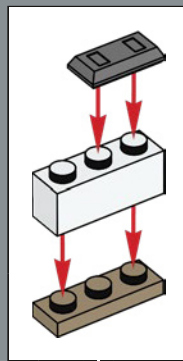
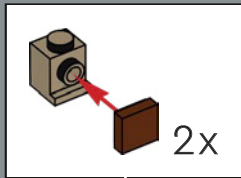

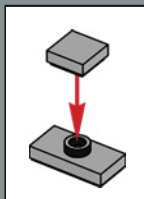
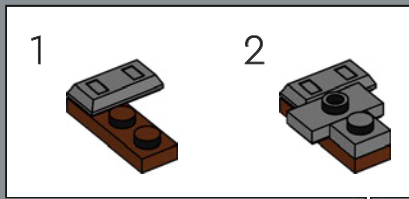
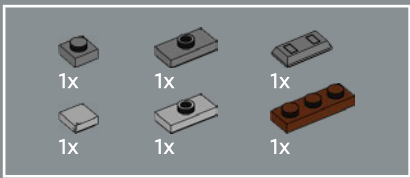

134

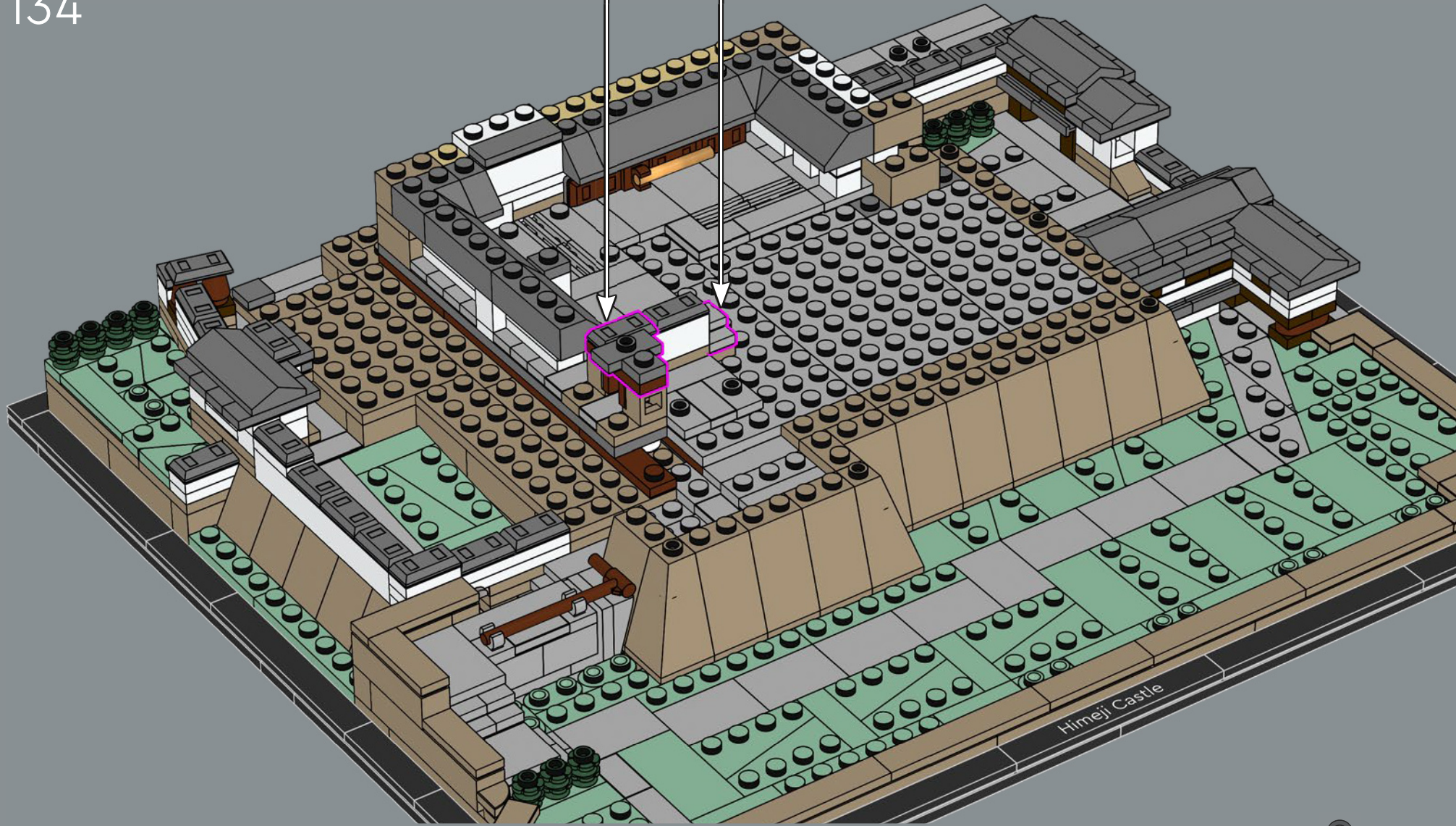

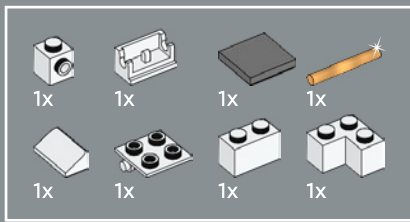

135

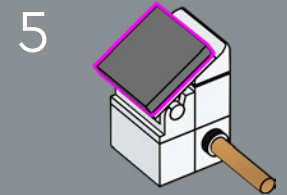
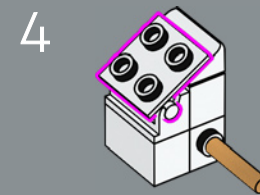
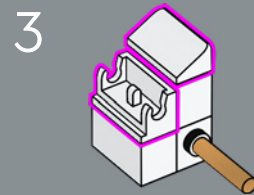
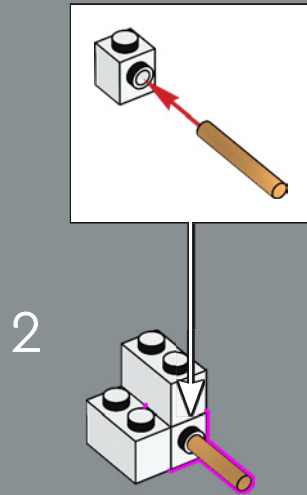
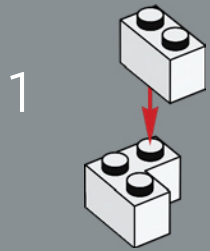

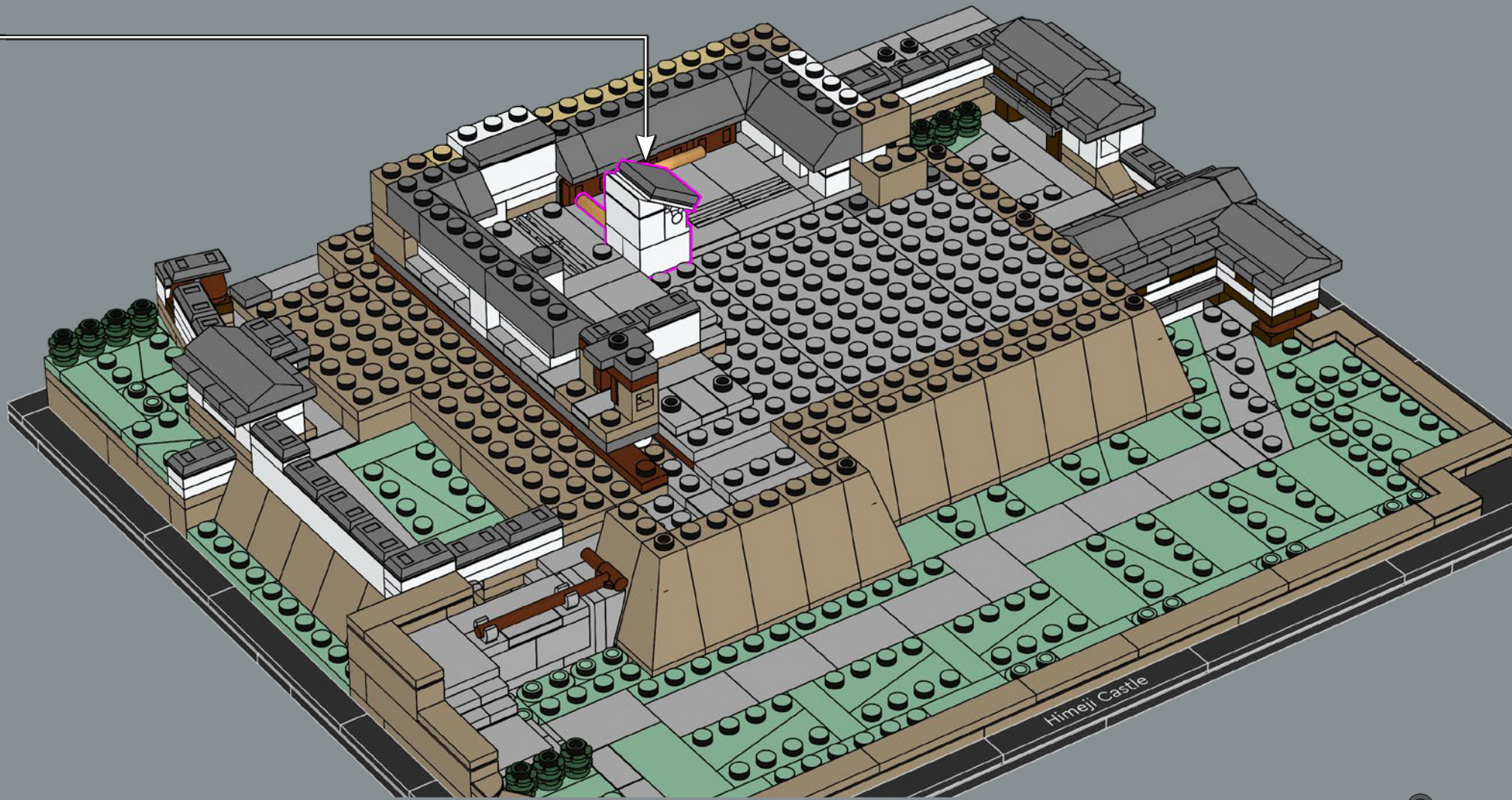

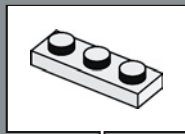
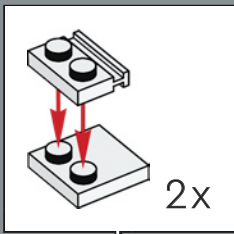
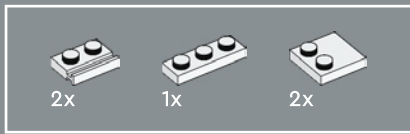

136



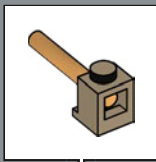
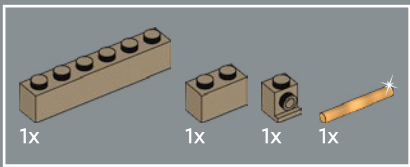

137

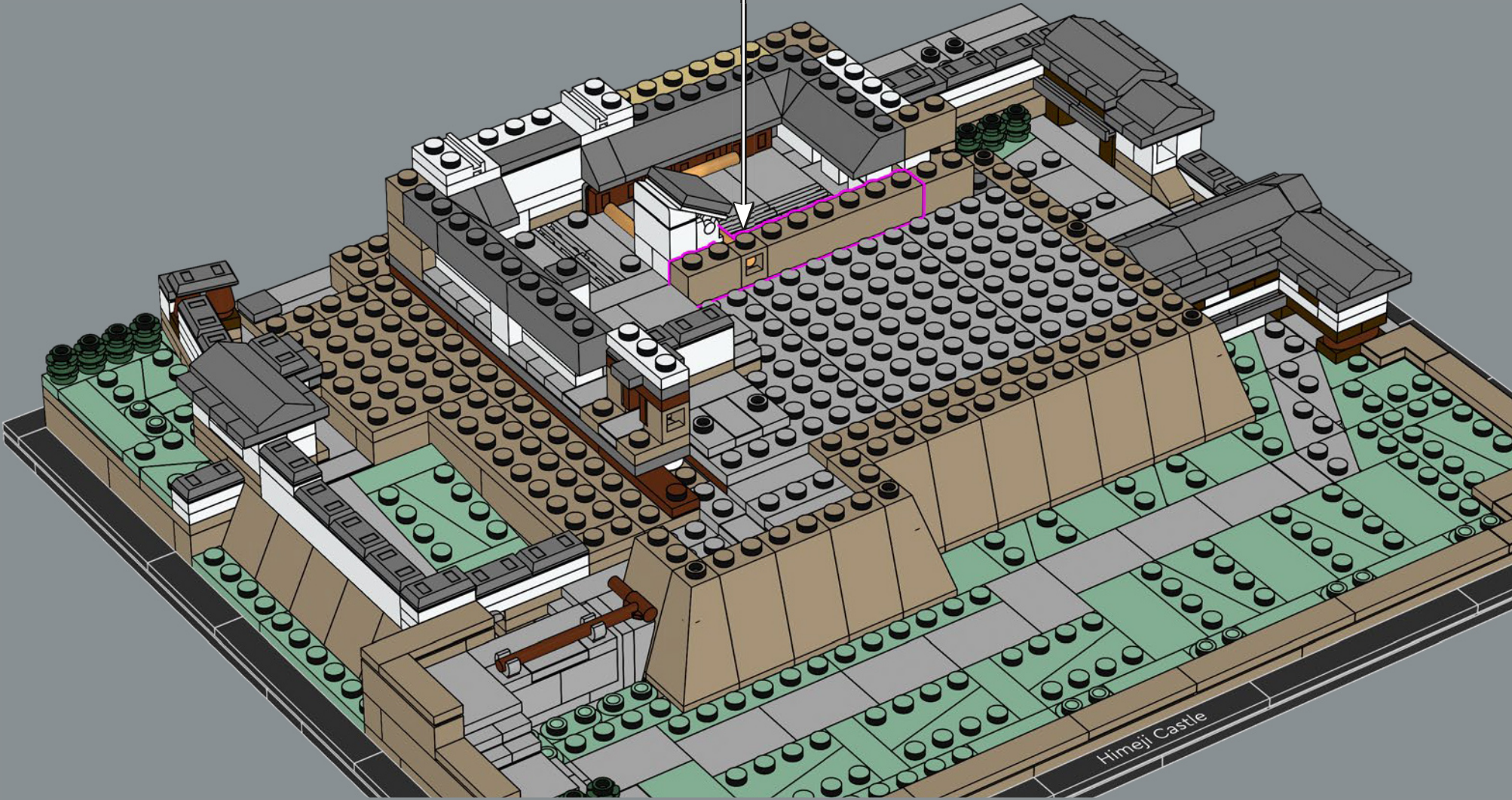

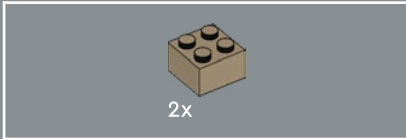
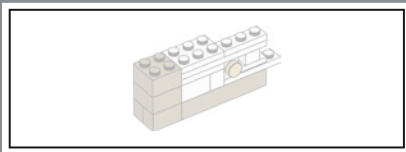

138

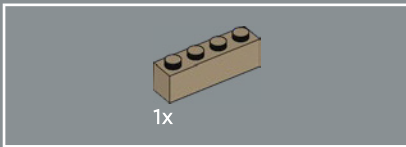
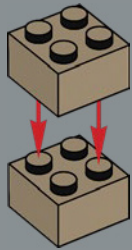

139

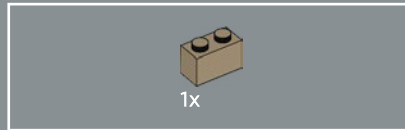
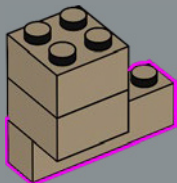

140

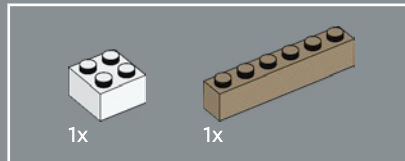
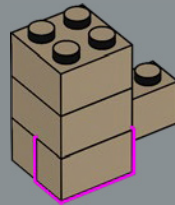

141

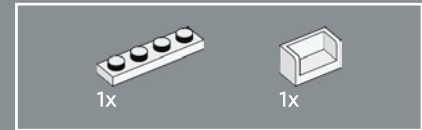
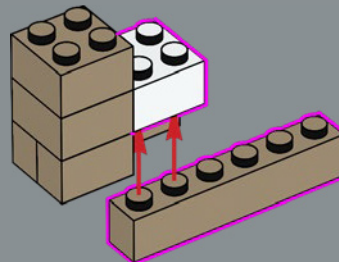

142

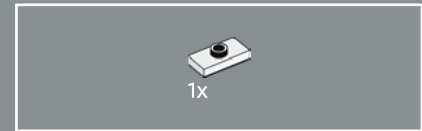
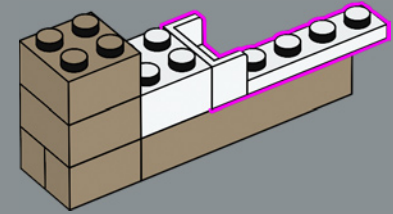

143

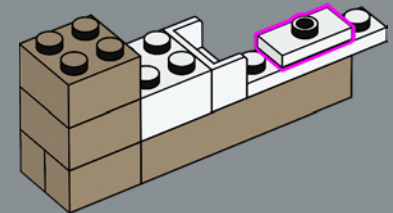

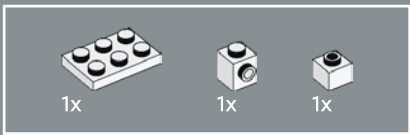

144

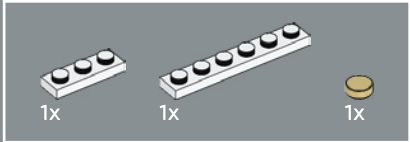
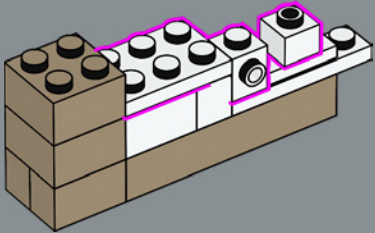

145

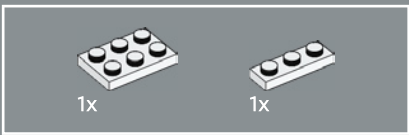
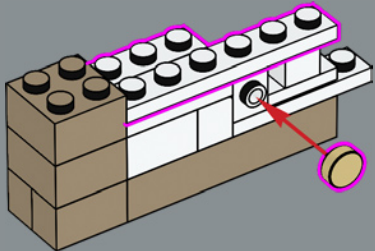

146

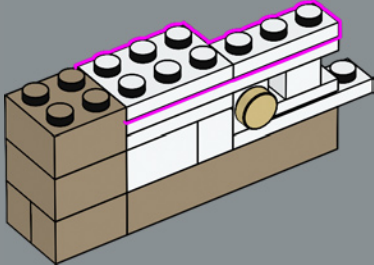

147

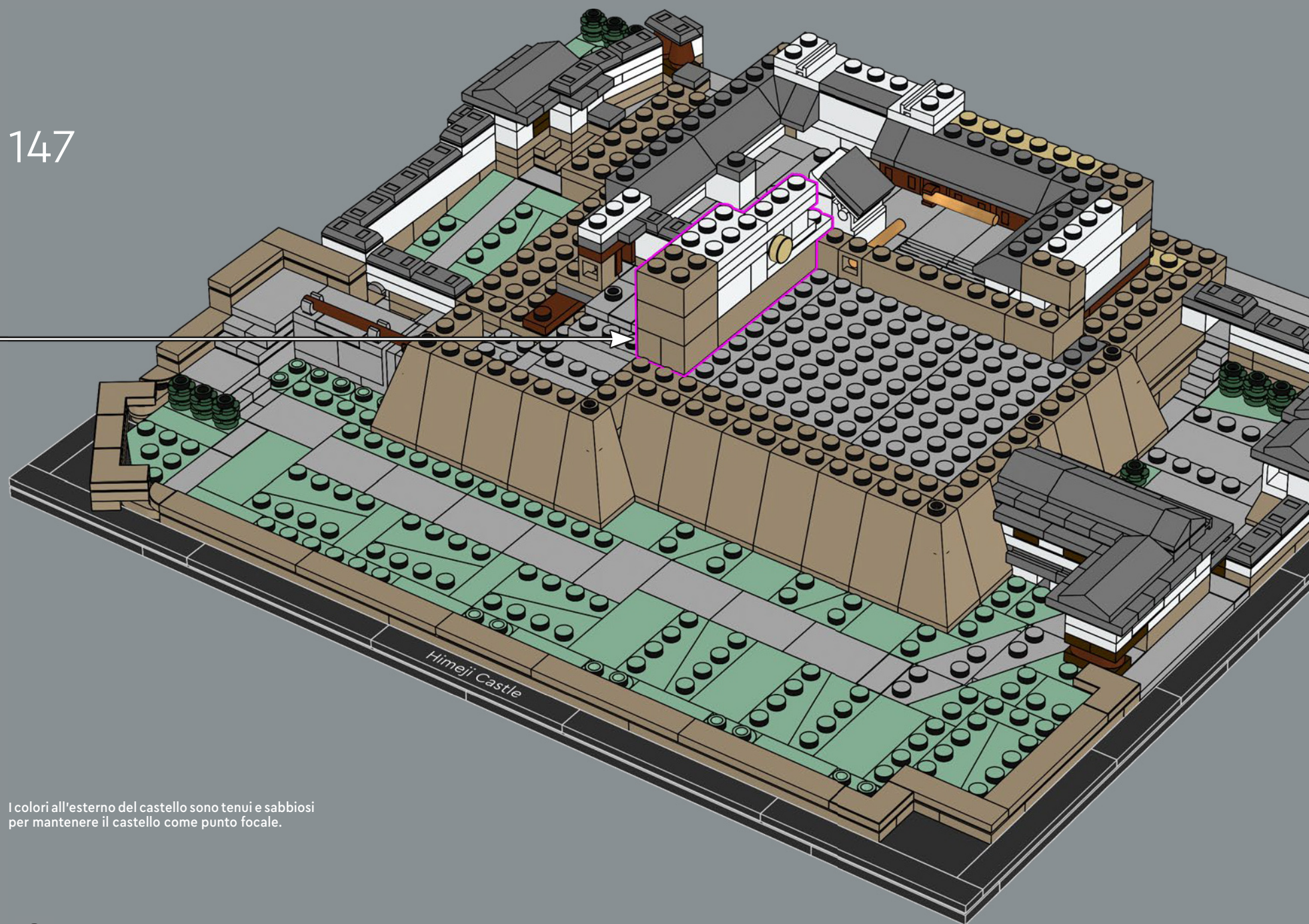

I colori all'esterno del castello sono tenui e sabbiosi per mantenere il castello come punto focale.

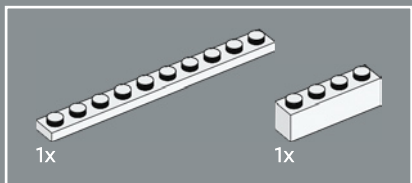

148

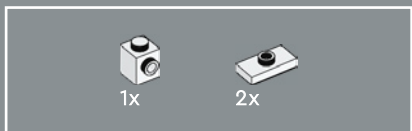
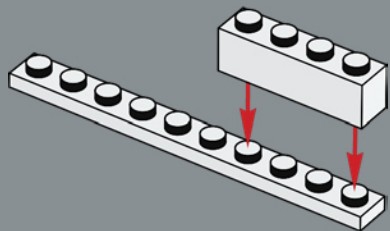

149

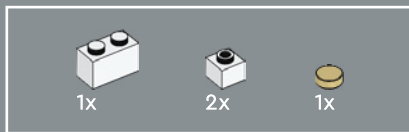
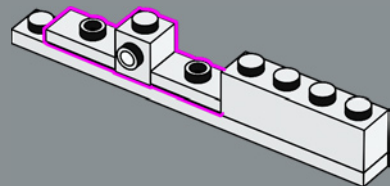

150

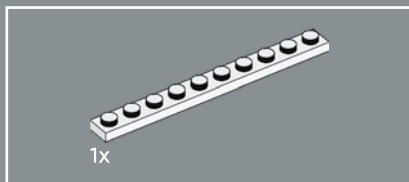
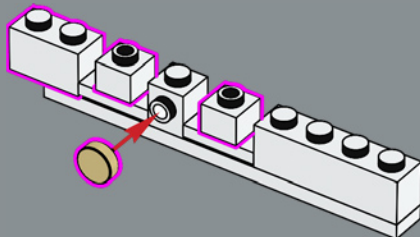

151

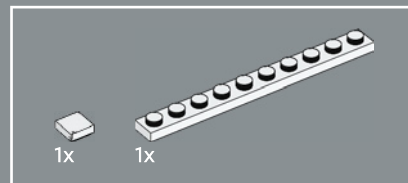
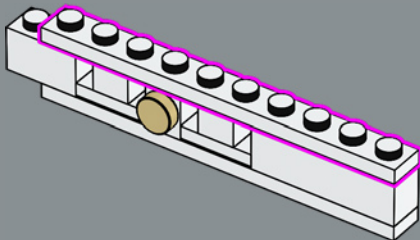

152

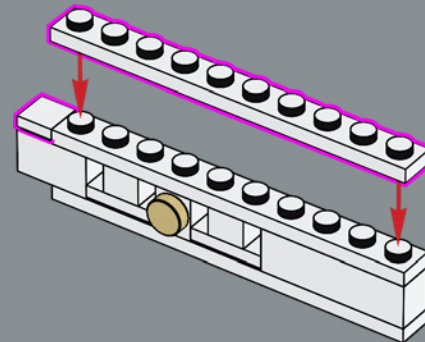

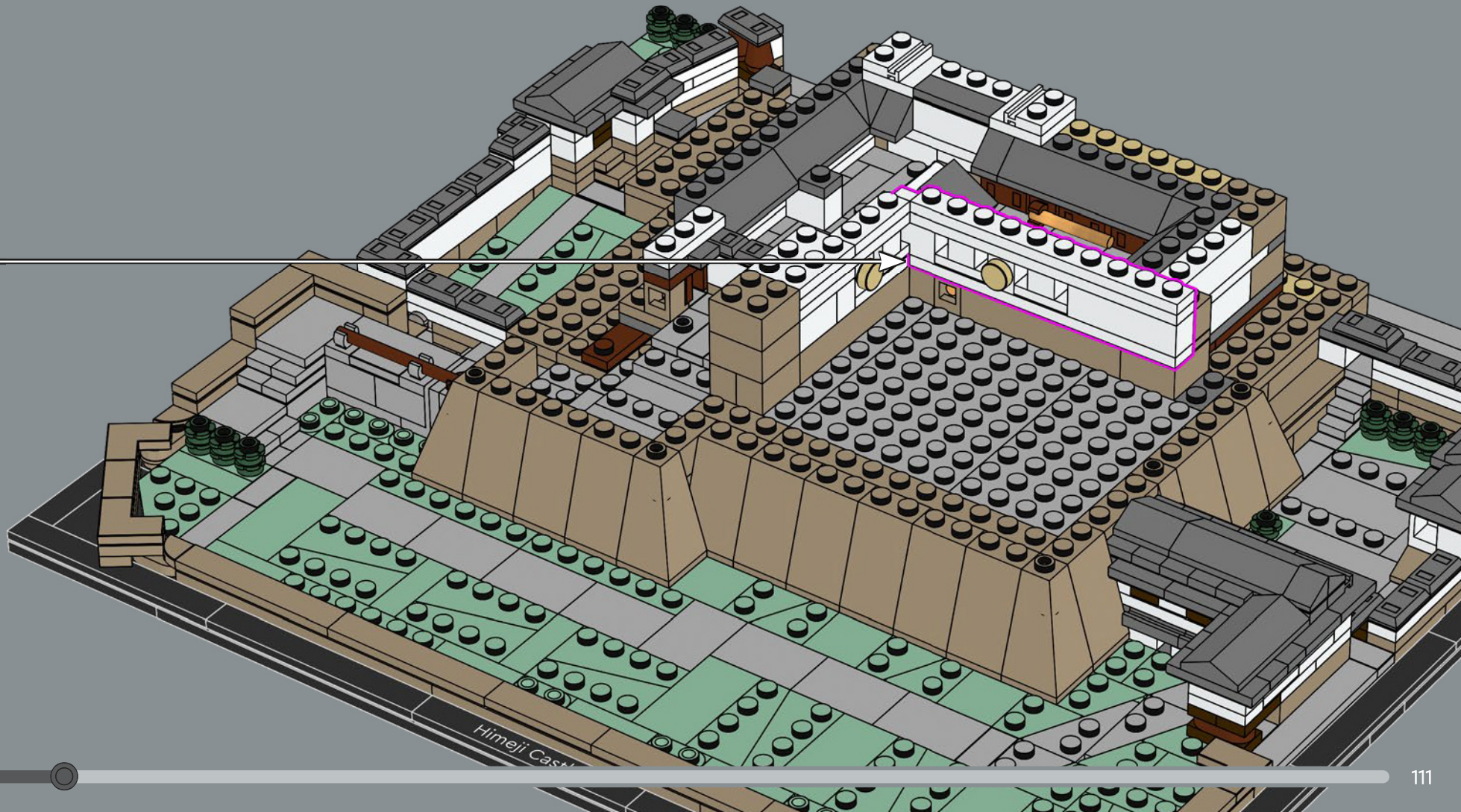

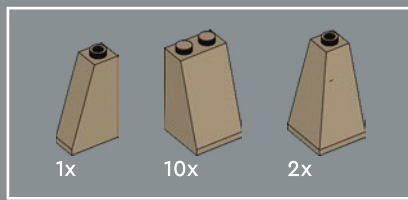

154

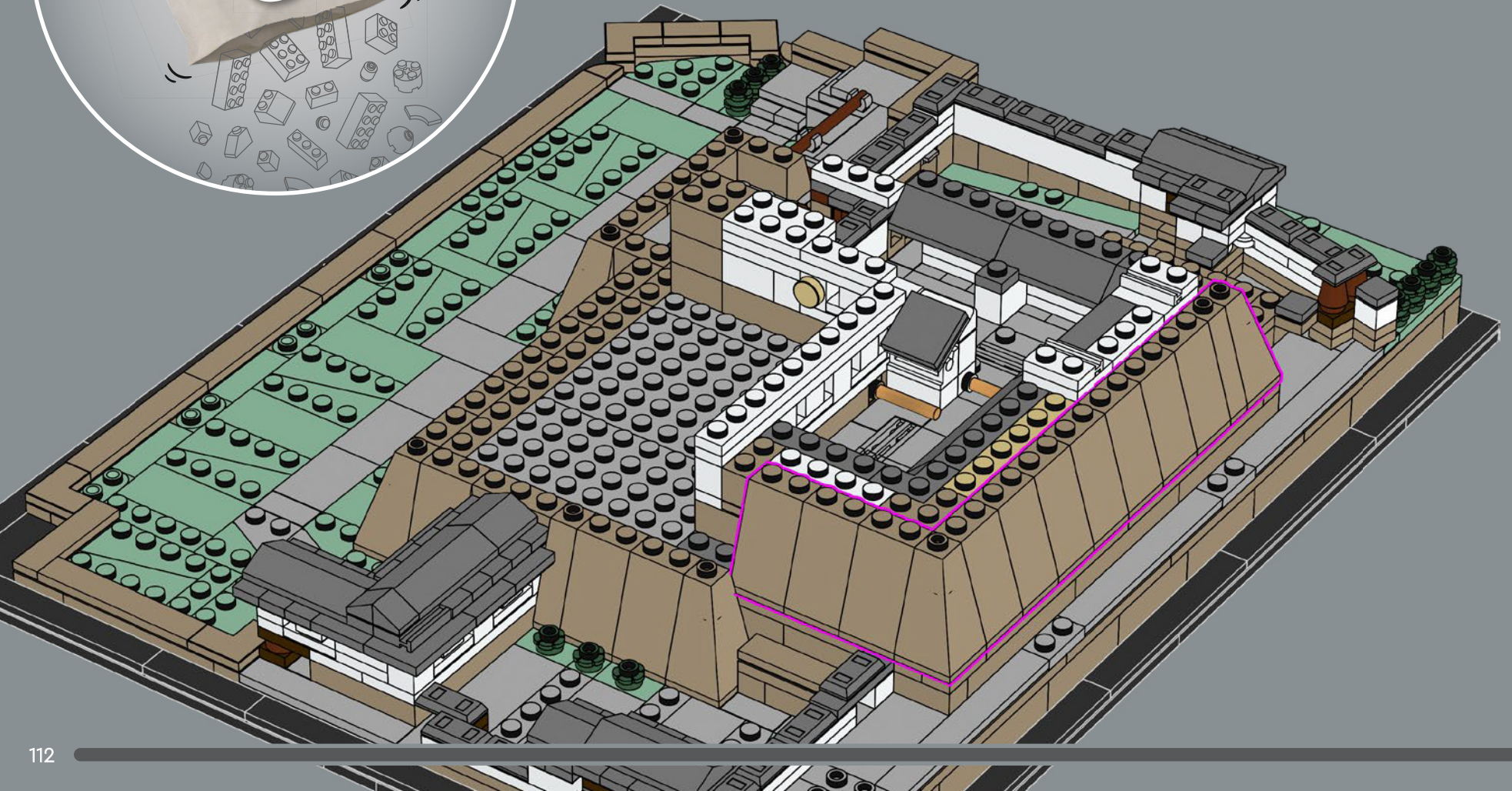

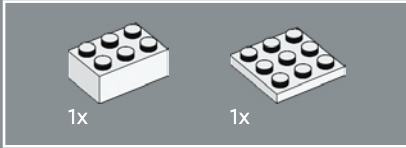

155

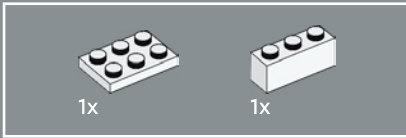
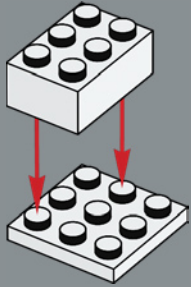

156

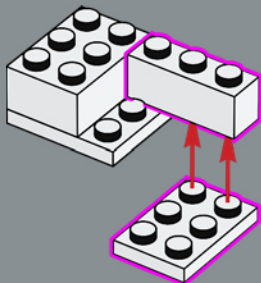

157

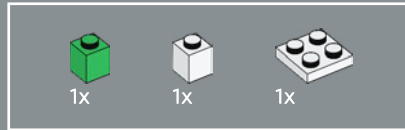
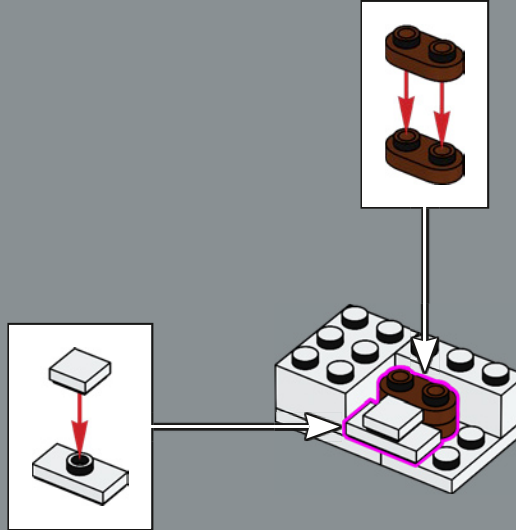

158

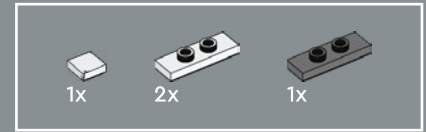
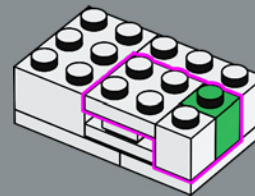

159

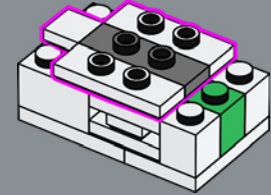

160

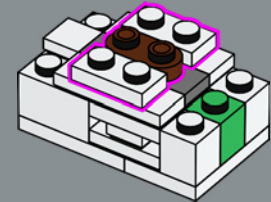

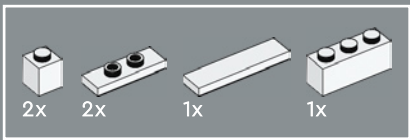

161

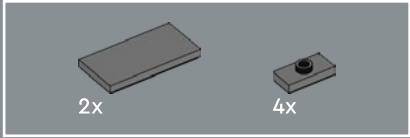
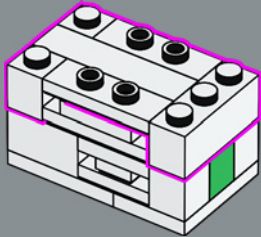

162

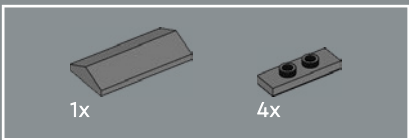
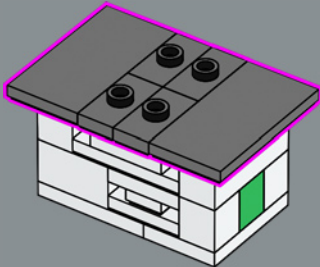

163

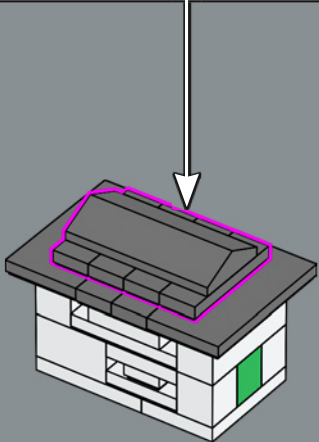
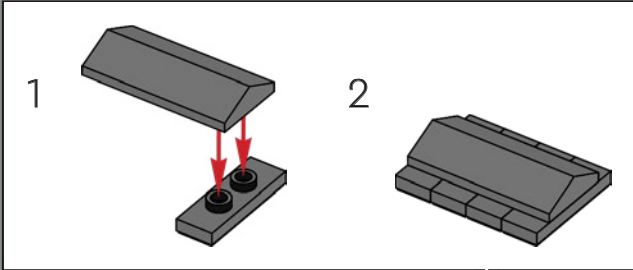

164

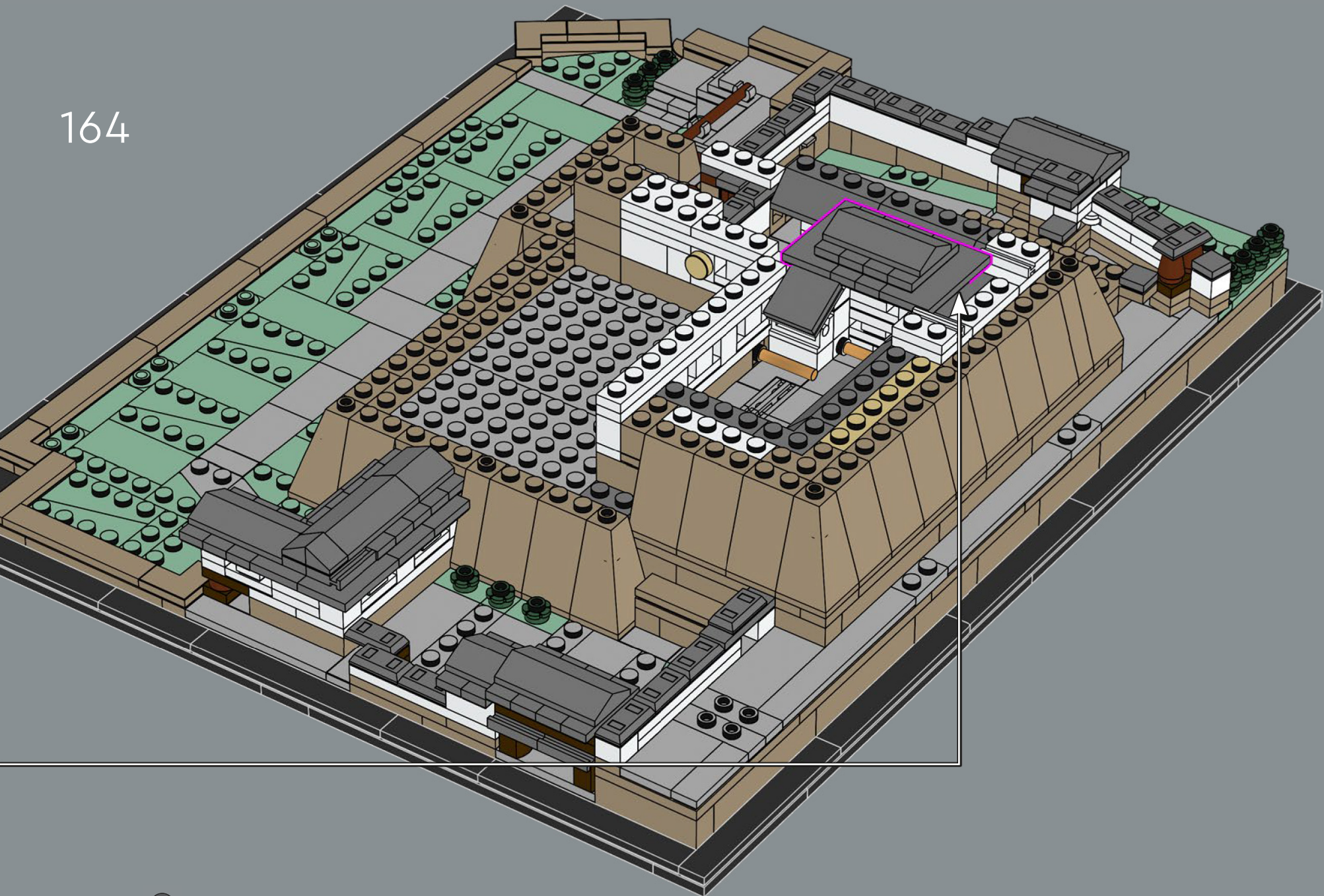

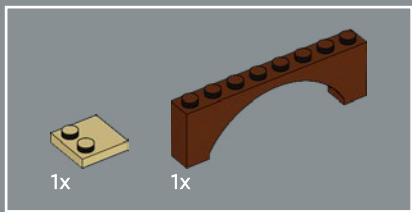

165

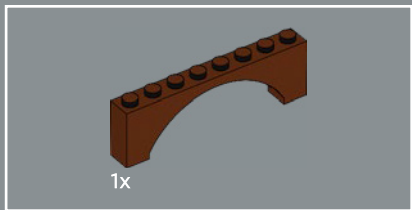
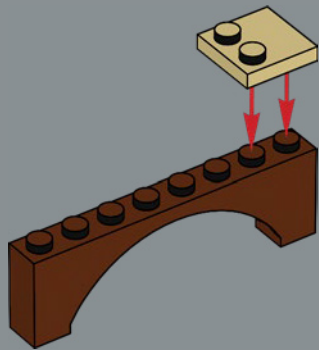

166

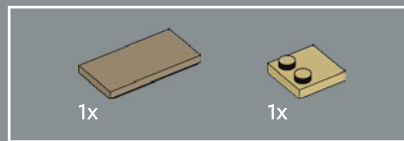
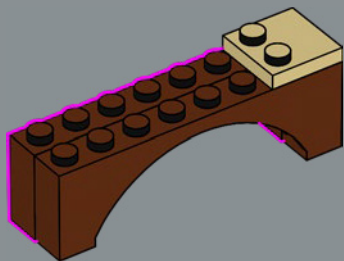

167

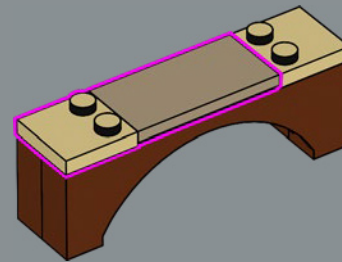

168

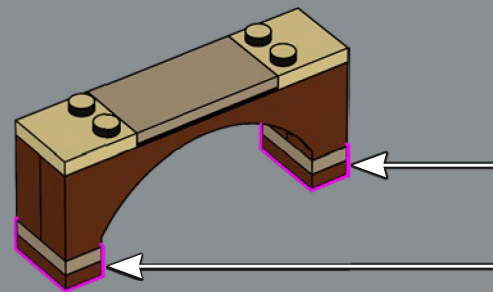
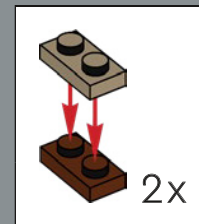

169

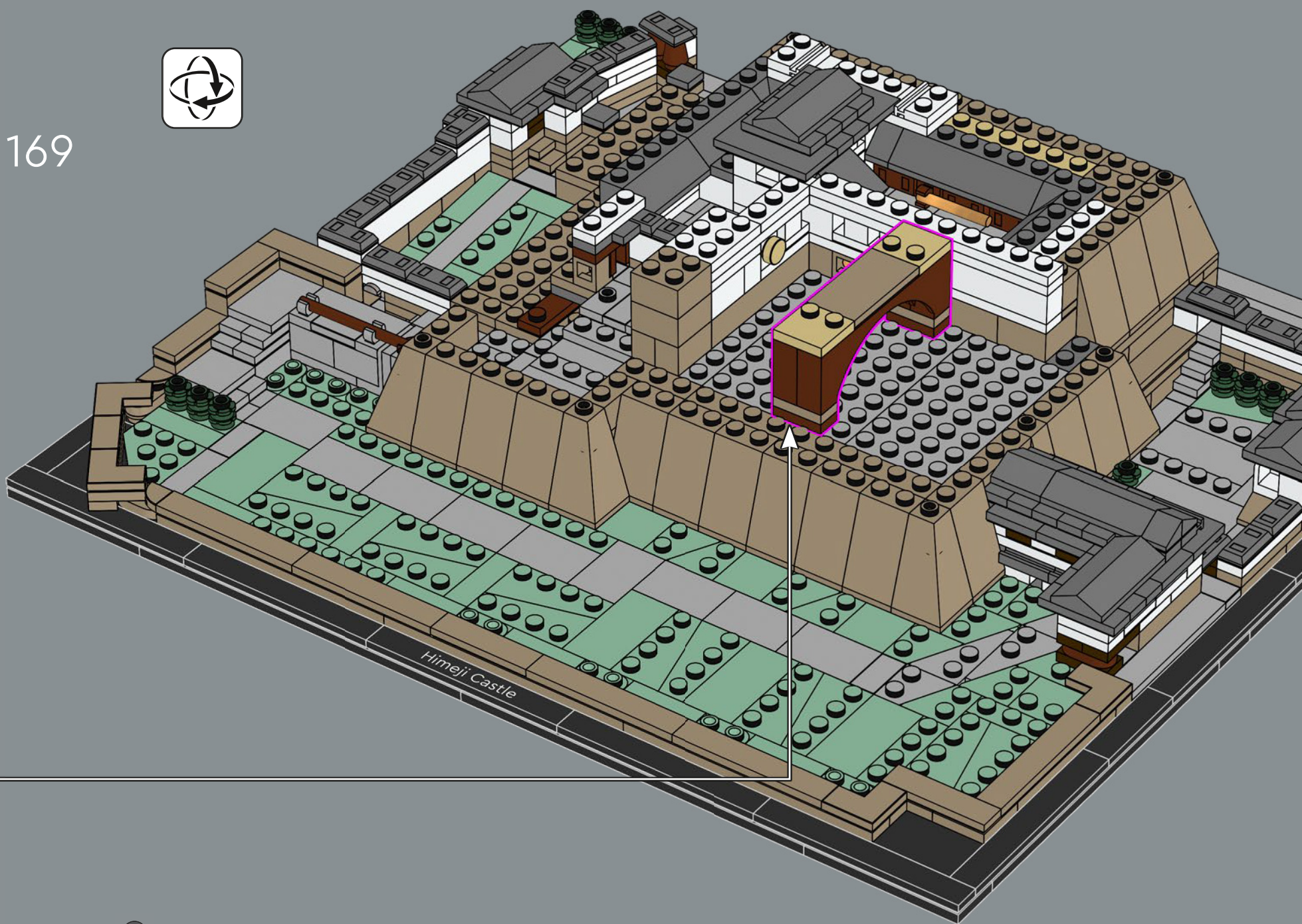

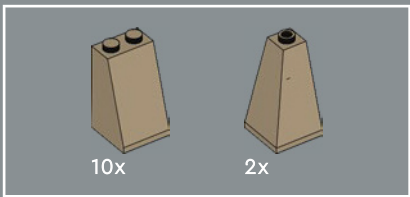

170

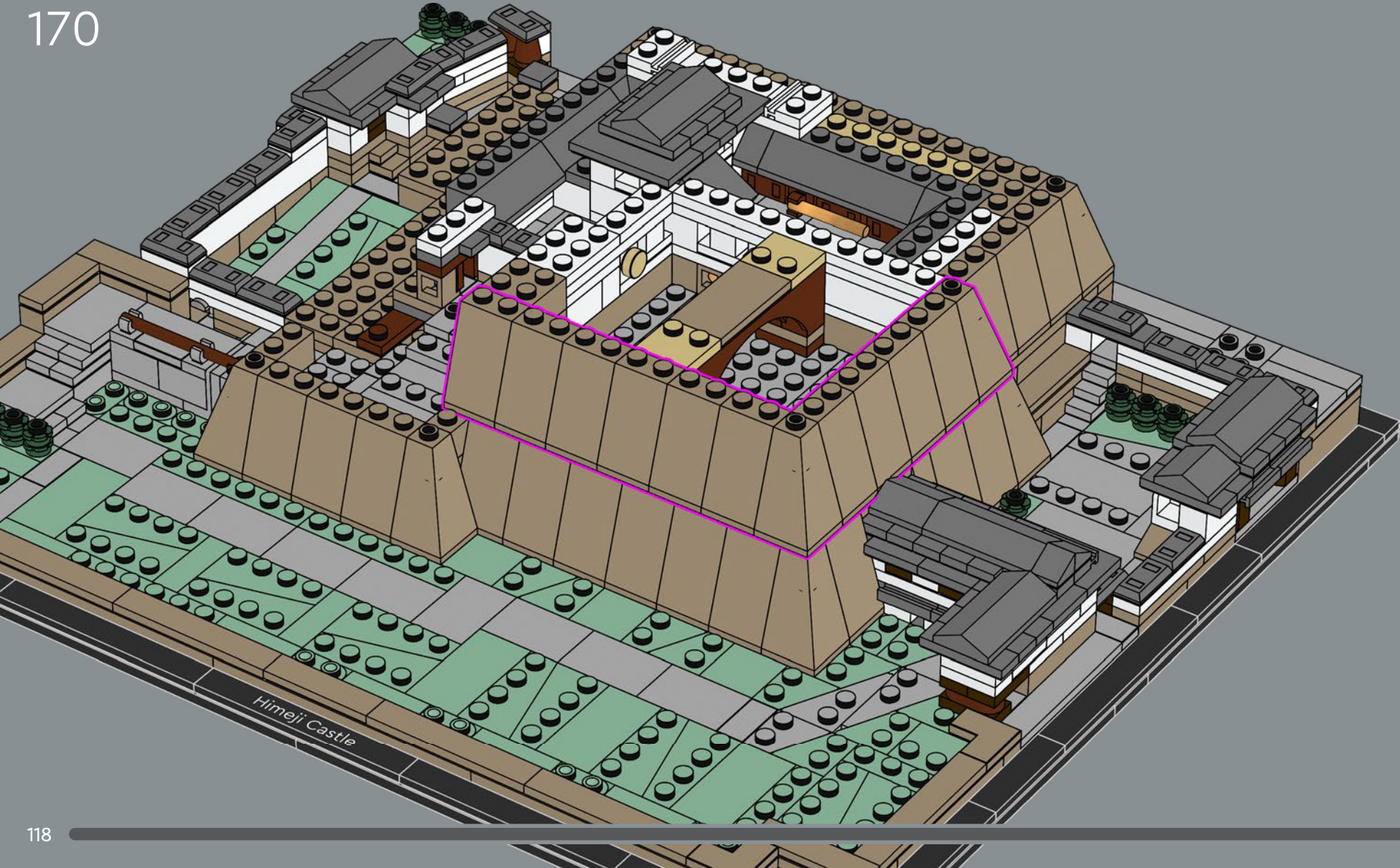

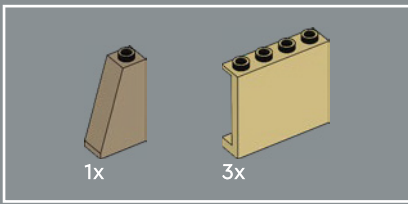

171



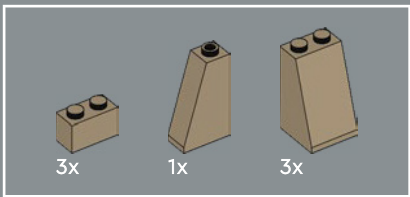

172

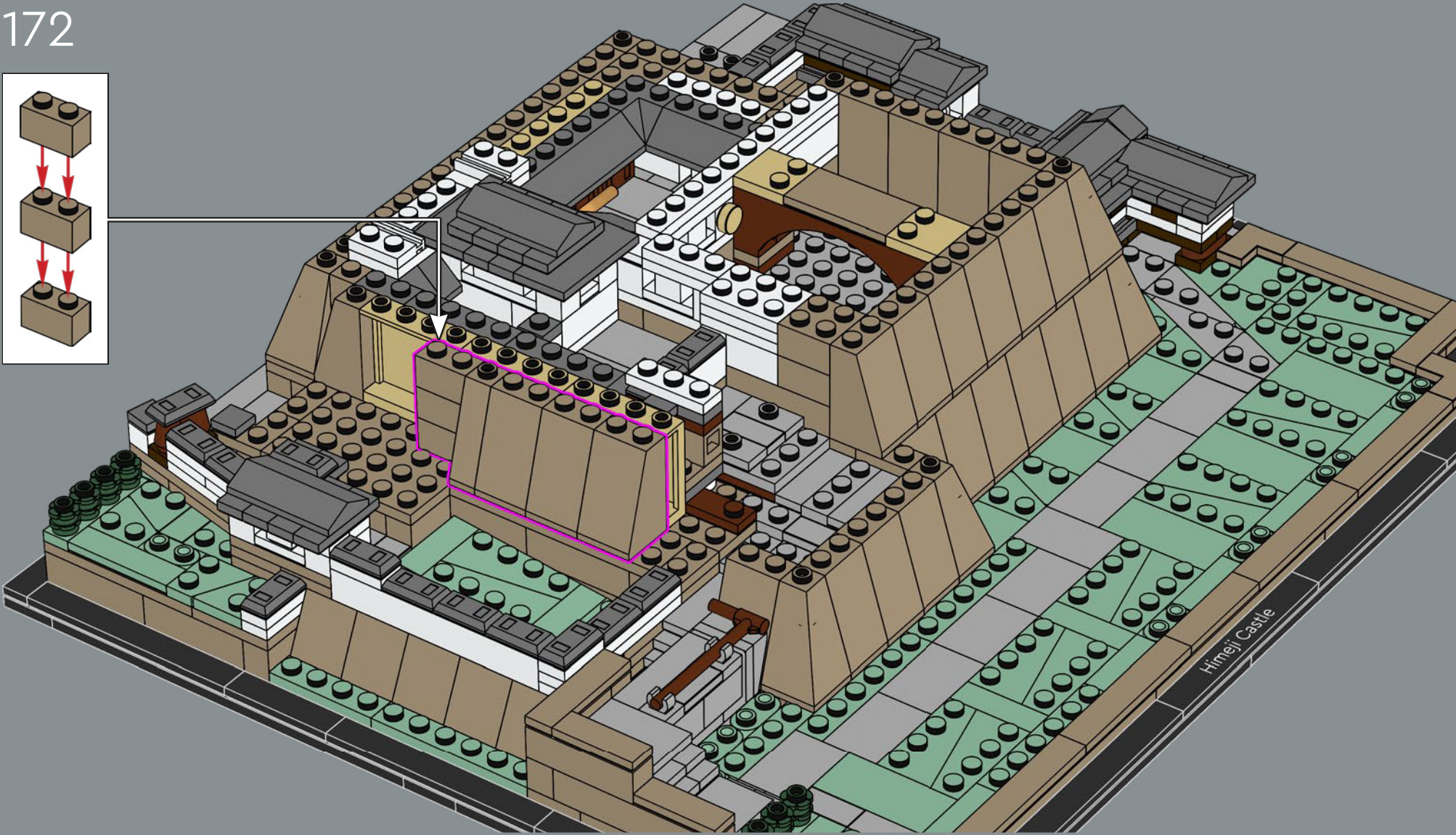
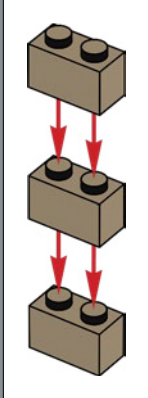

Himeji Castle

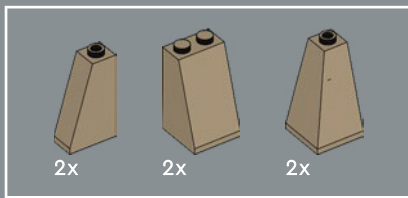

173



Himeji Castle

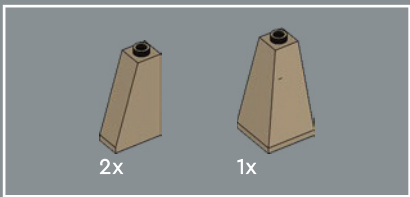

174

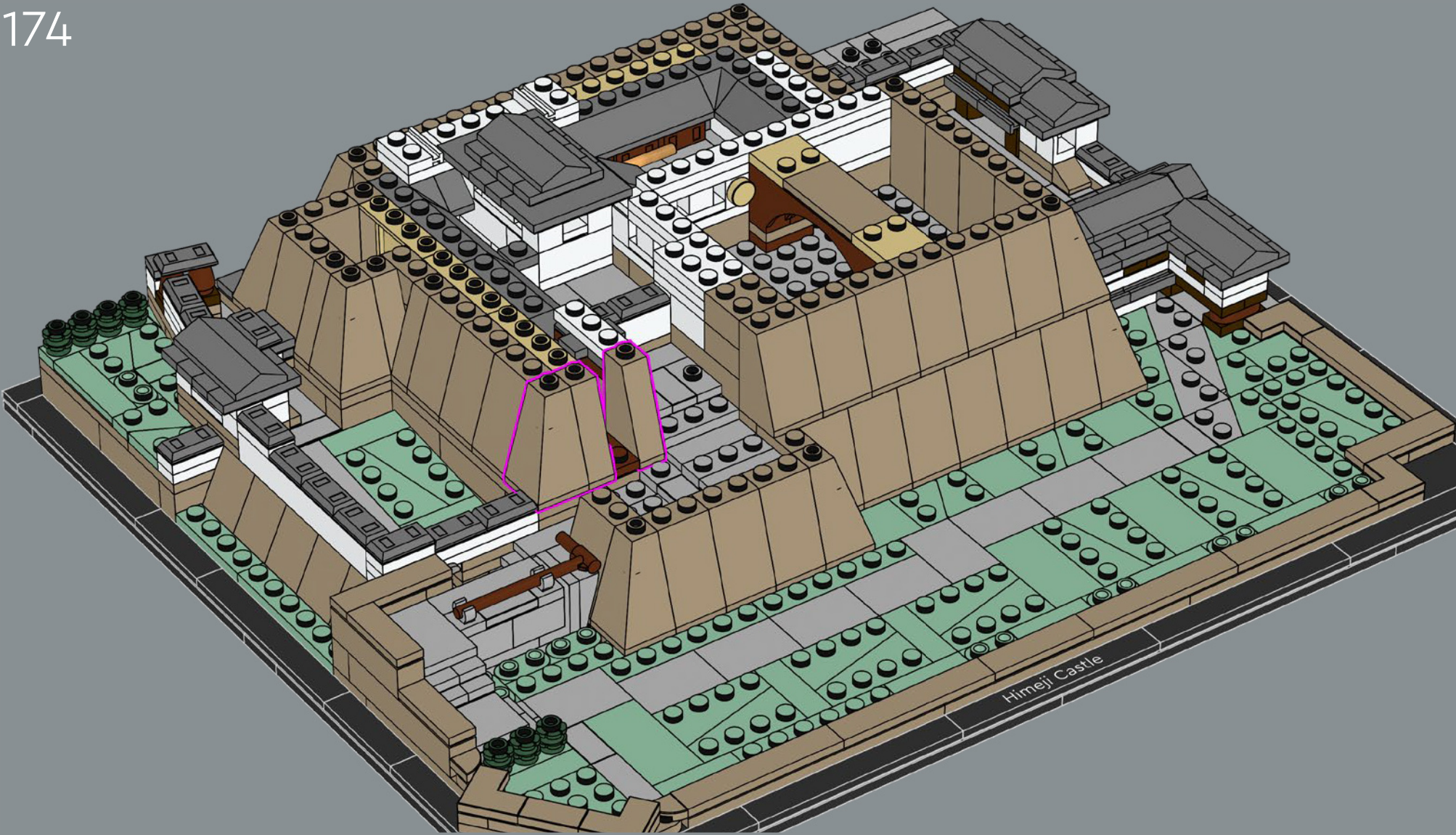

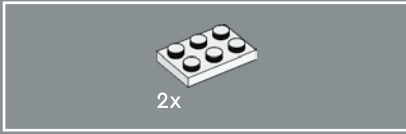
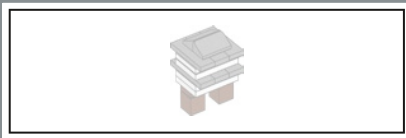

175

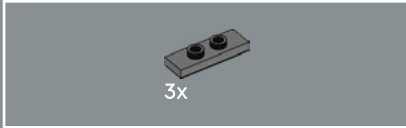
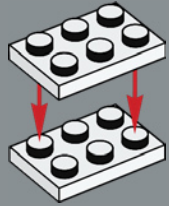

176

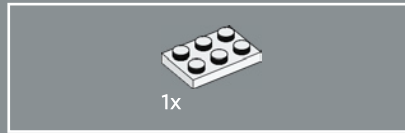

177

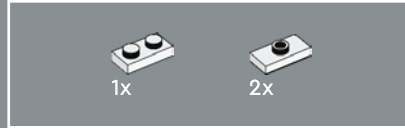
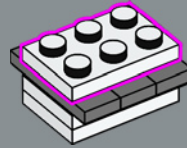

178

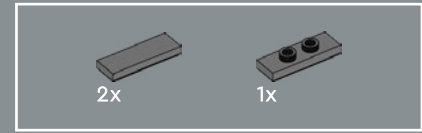
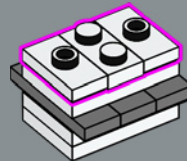

179

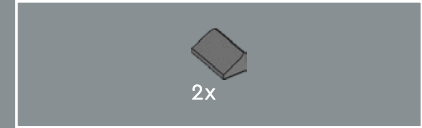
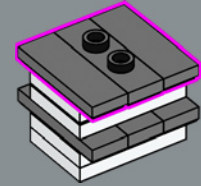

180

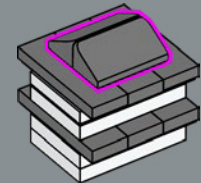

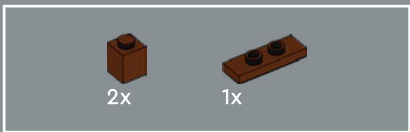

181

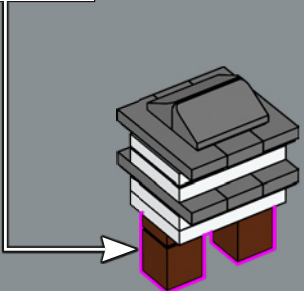
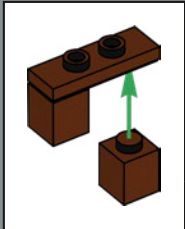

182



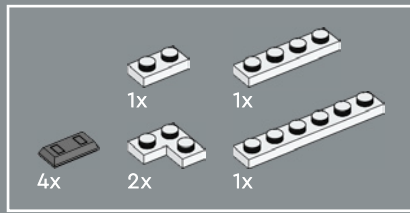

183

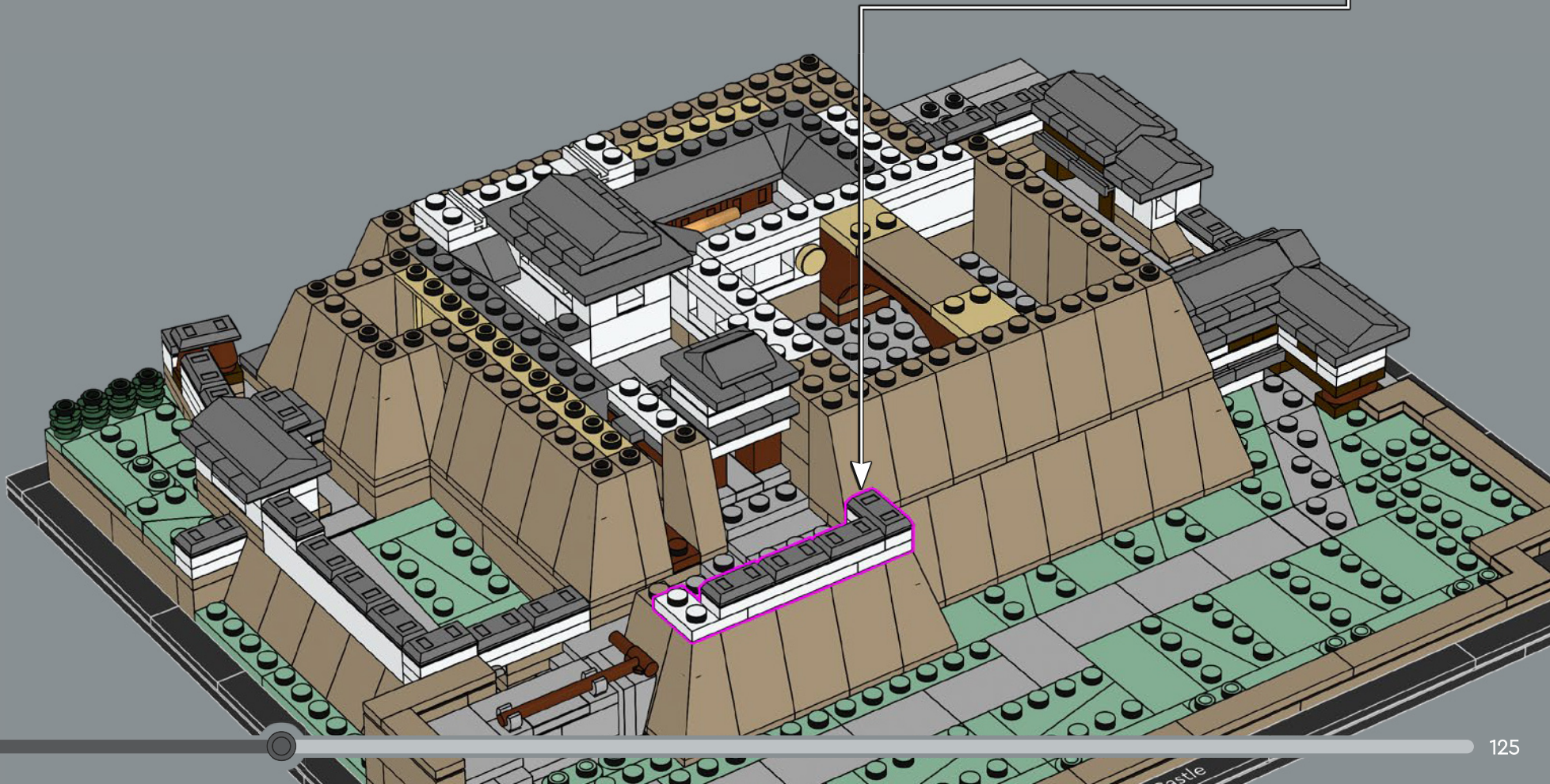
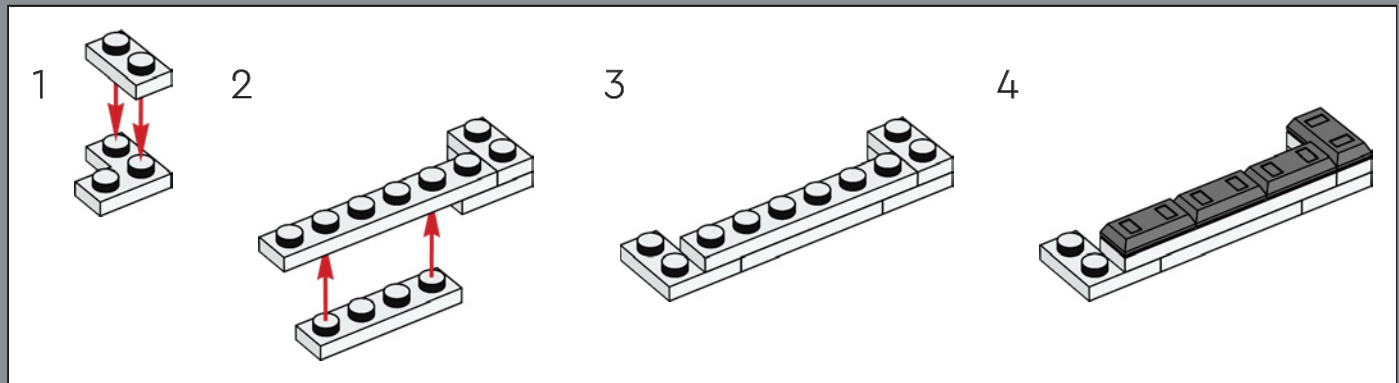

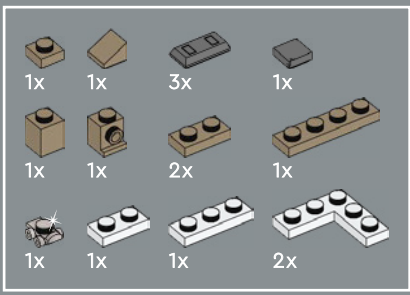

184

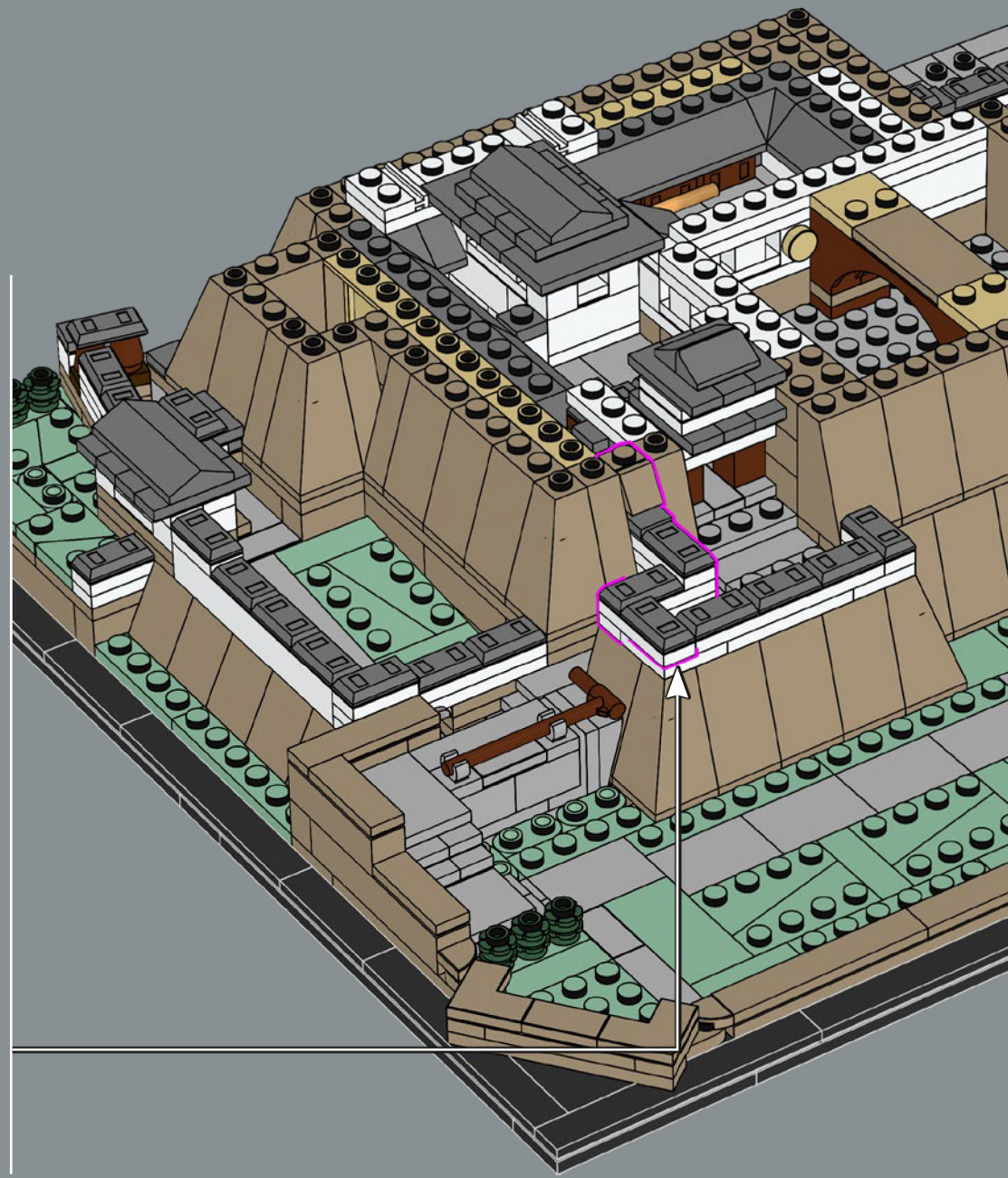
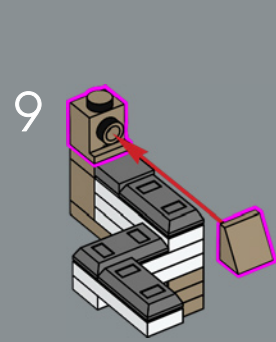
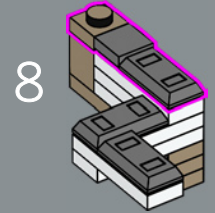
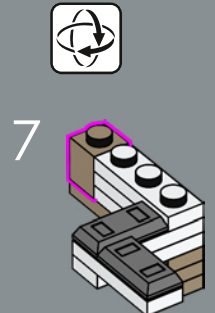
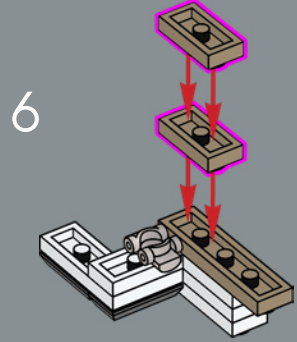
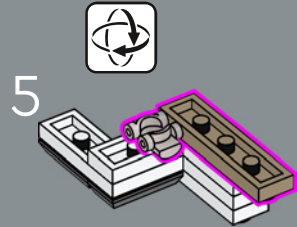
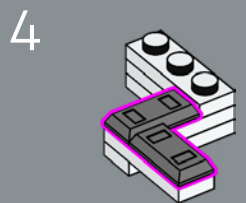
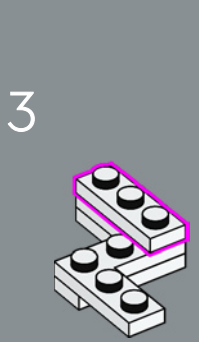
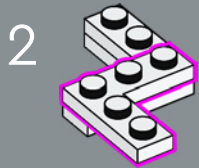
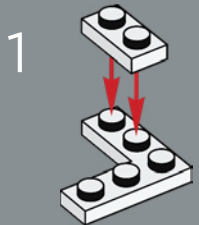

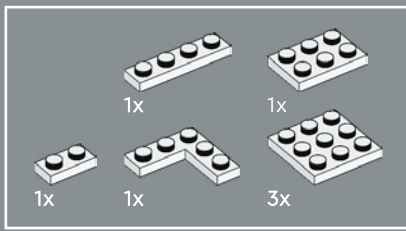

185

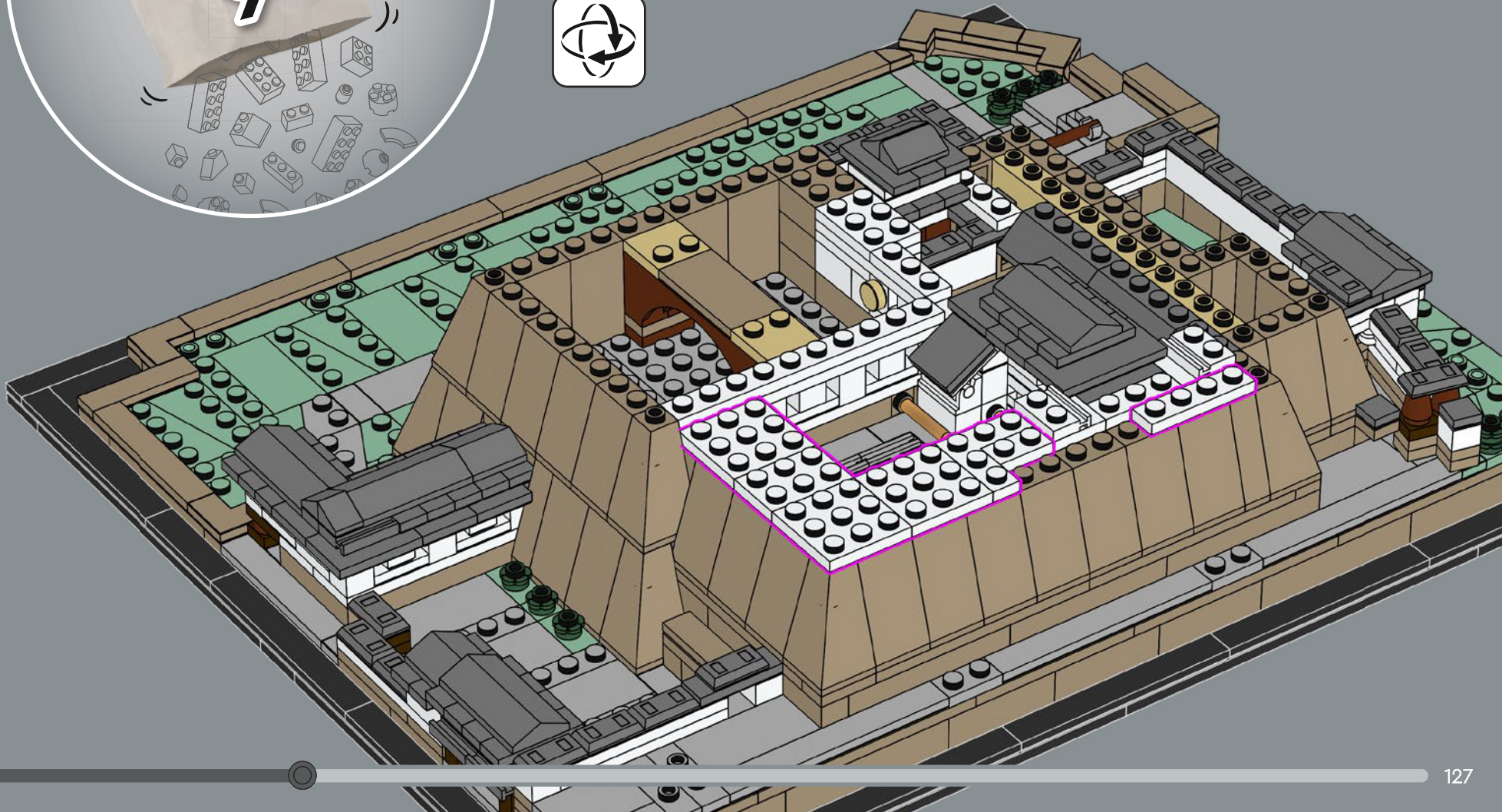

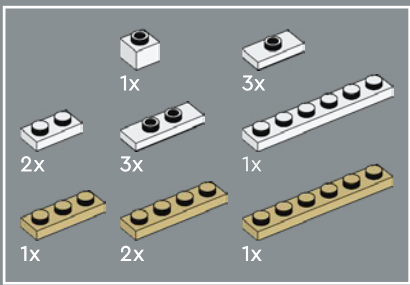

186

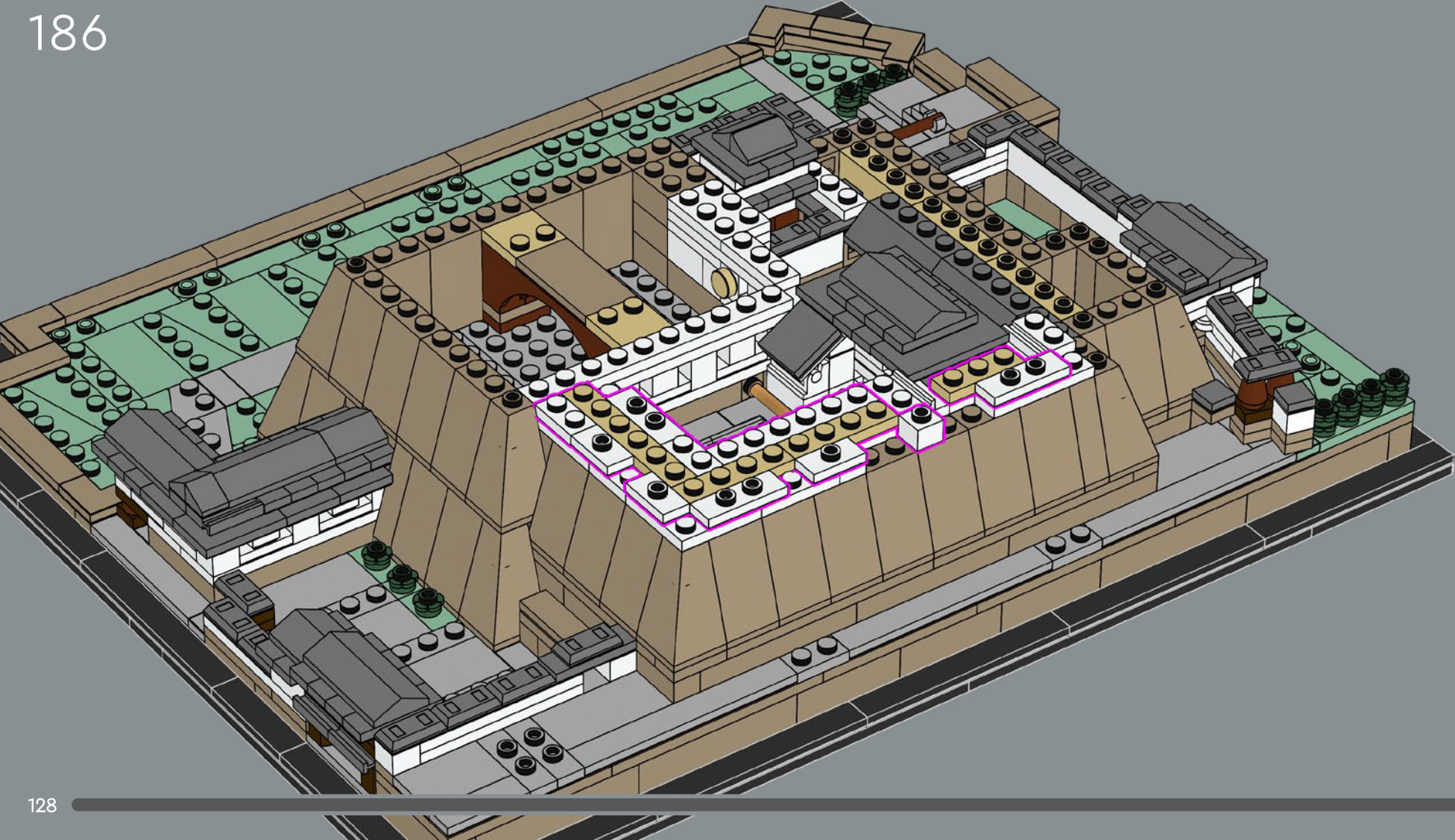

Durante i lavori di ristrutturazione del 2009-2015, diversi lati delle impalcature esterne furono dotati di disegni lineari del castello per garantire la visibilità dell'iconico punto di riferimento nella skyline di Himeji.

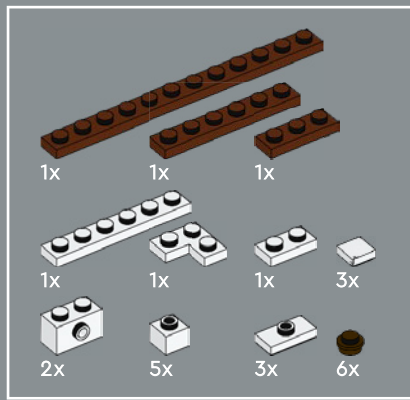

187



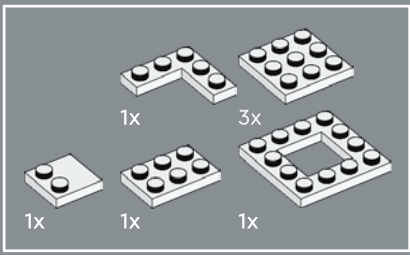

188

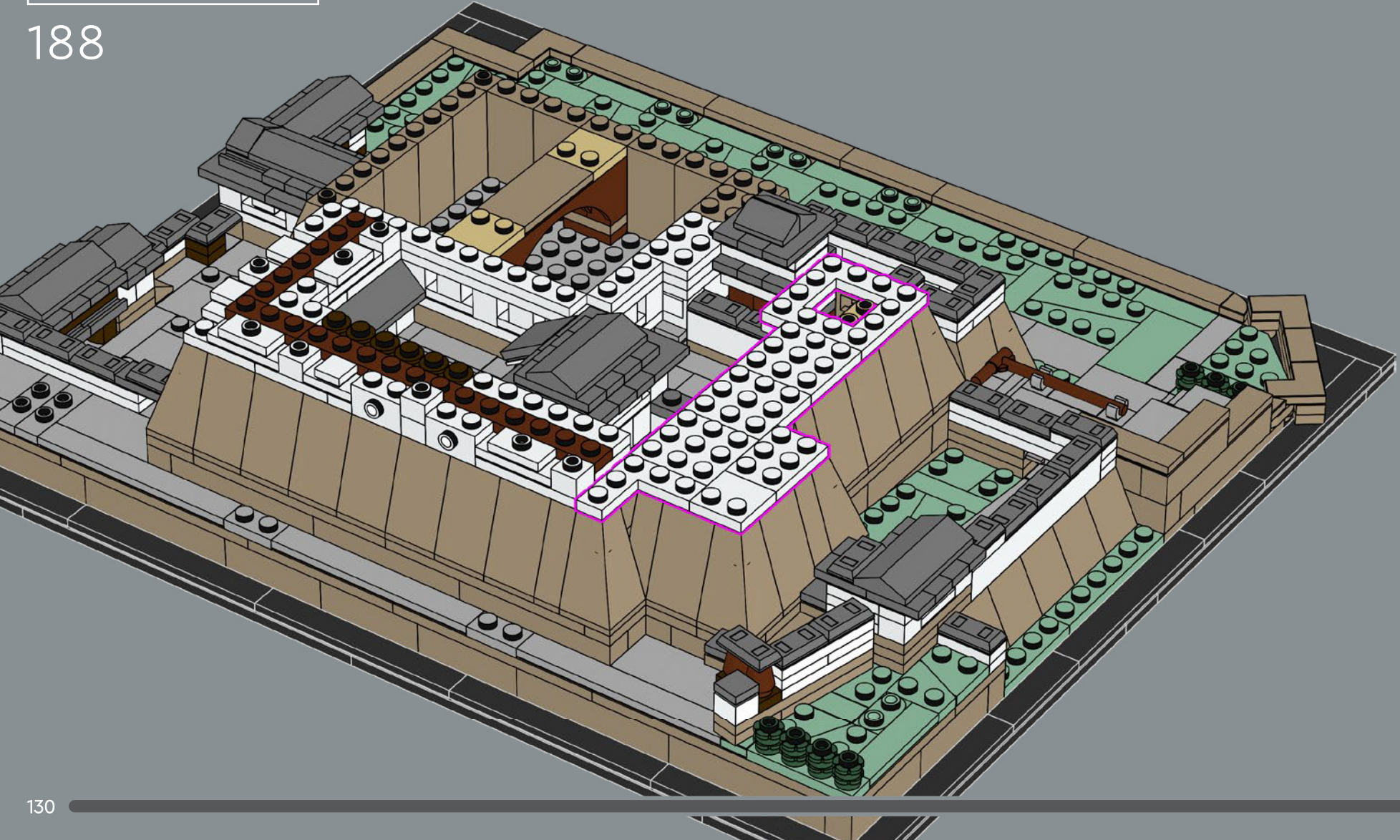

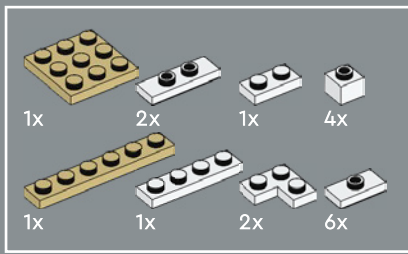

189

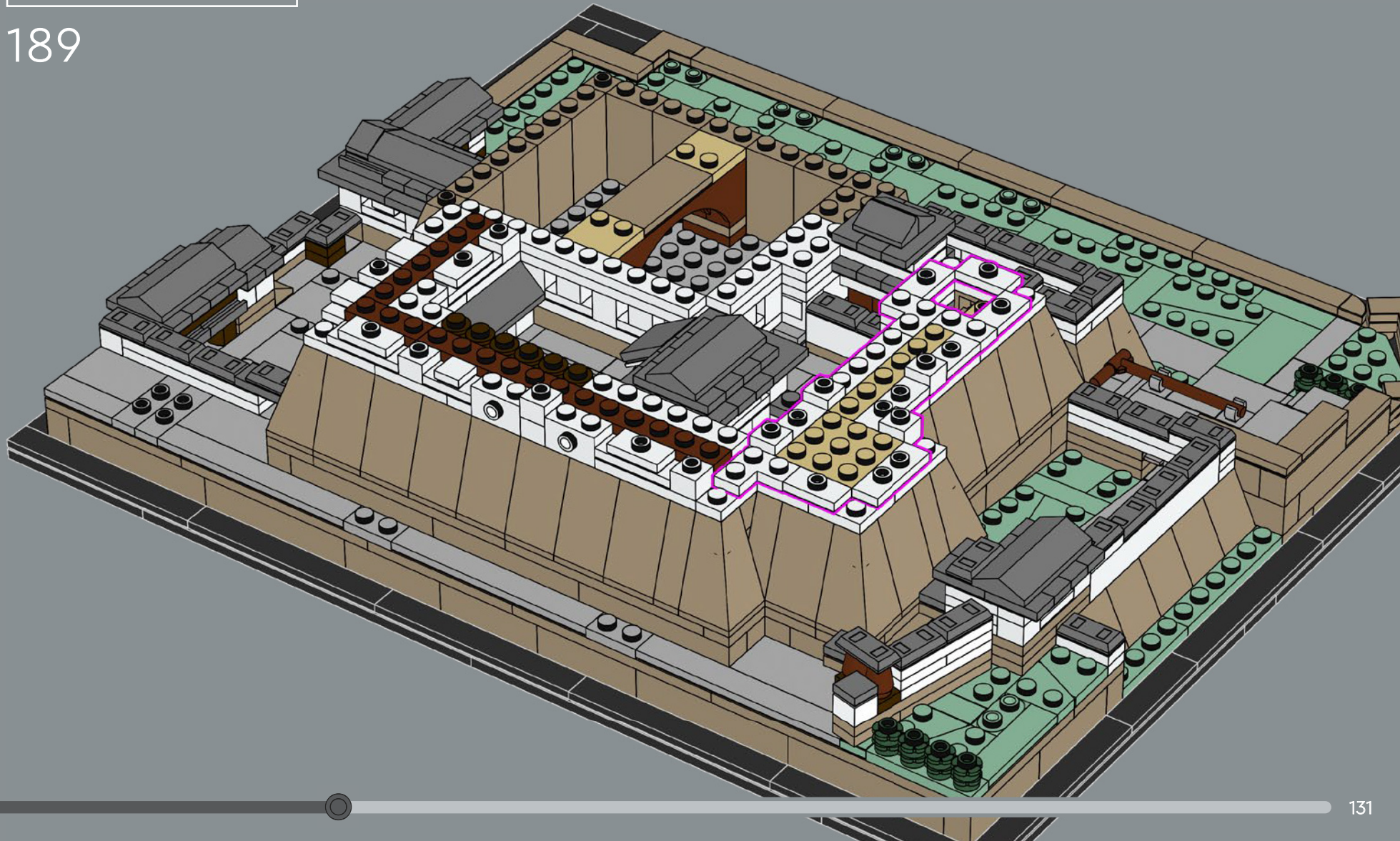

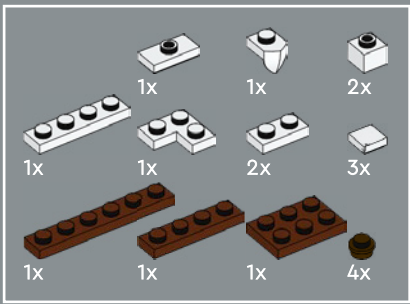

190



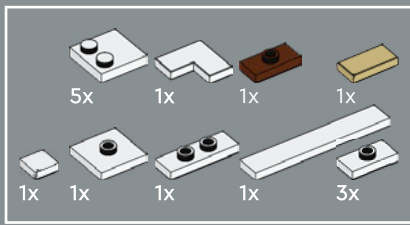

191

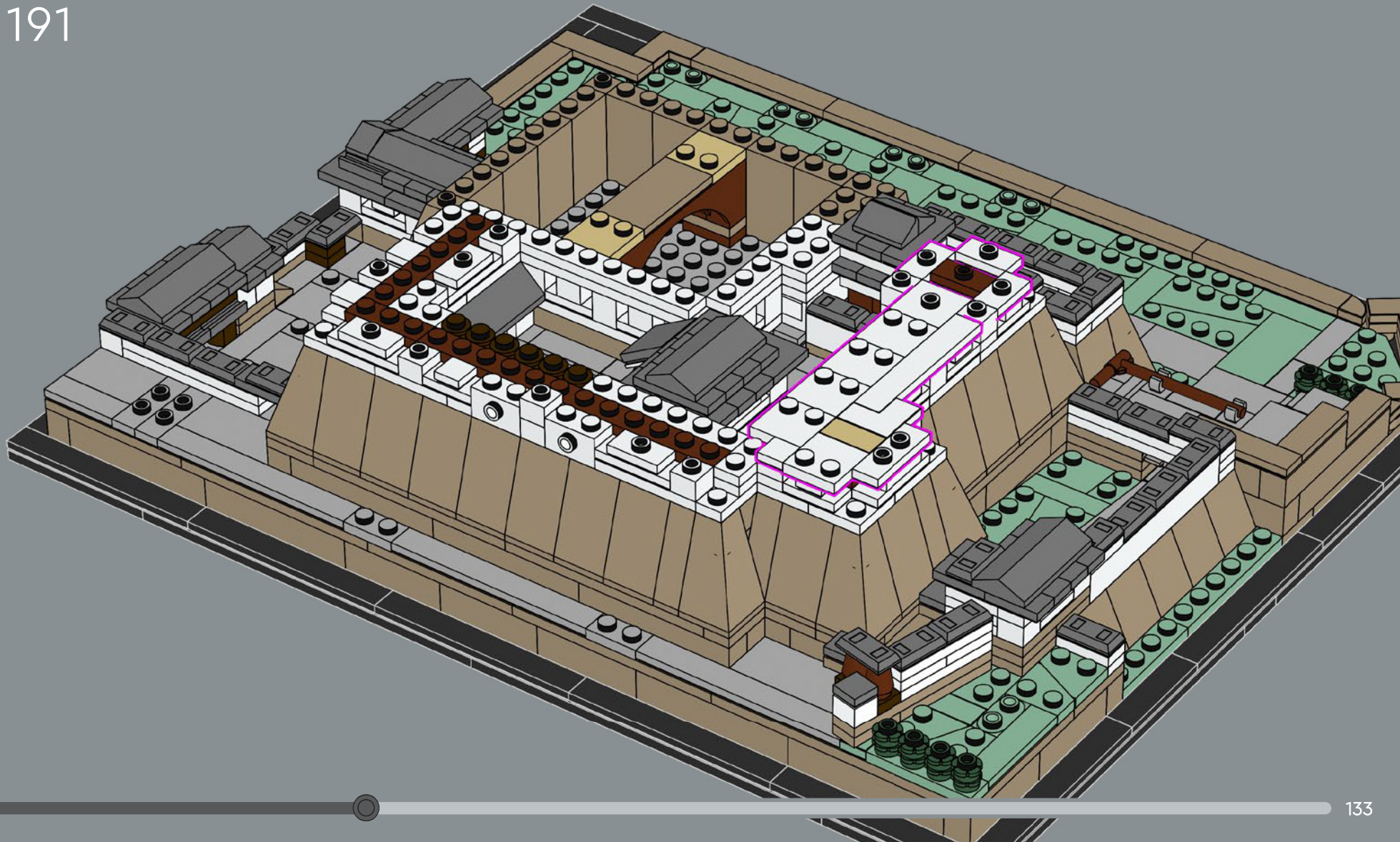

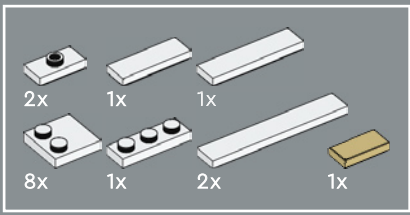

192

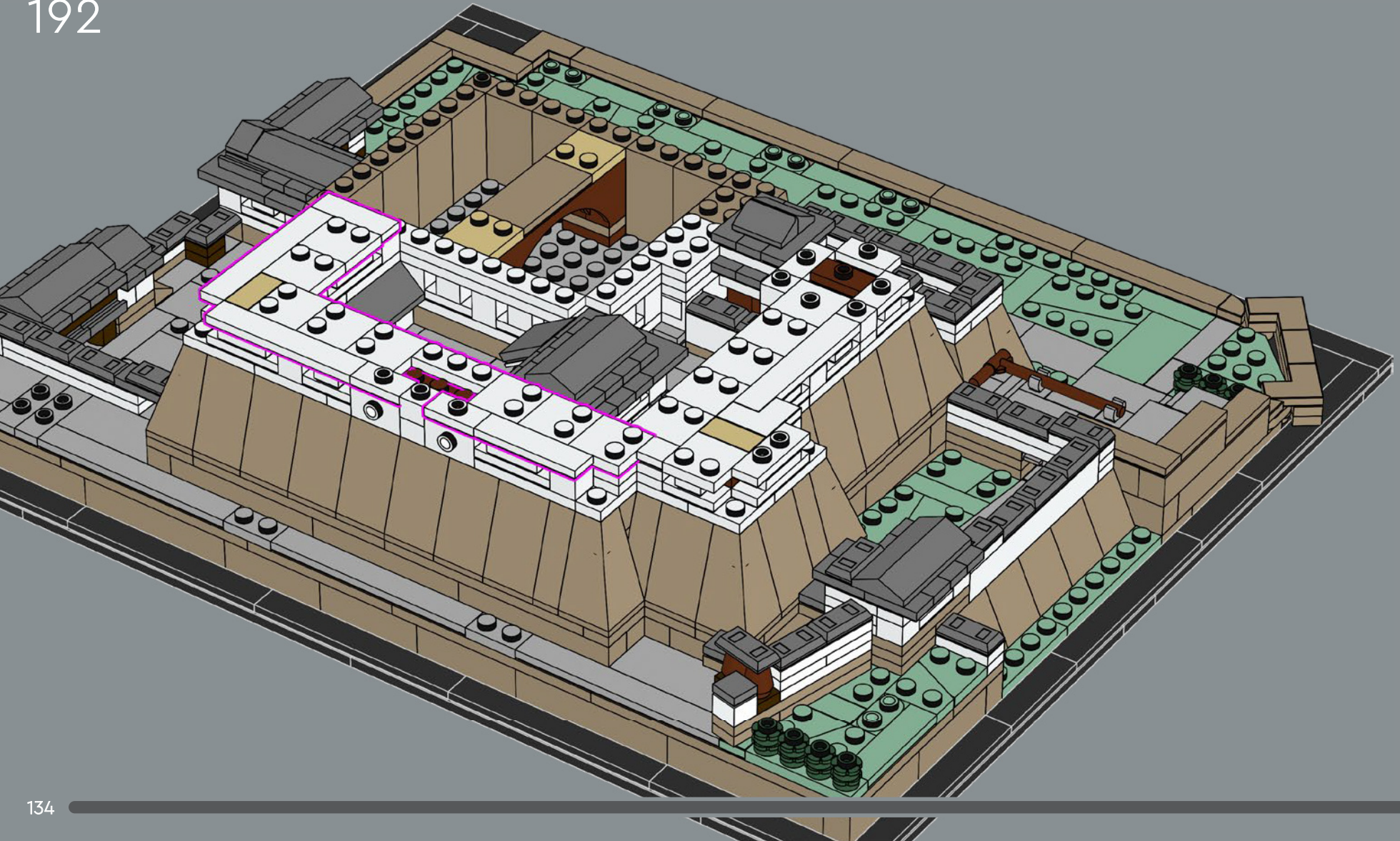

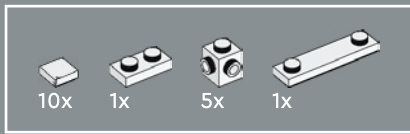

193

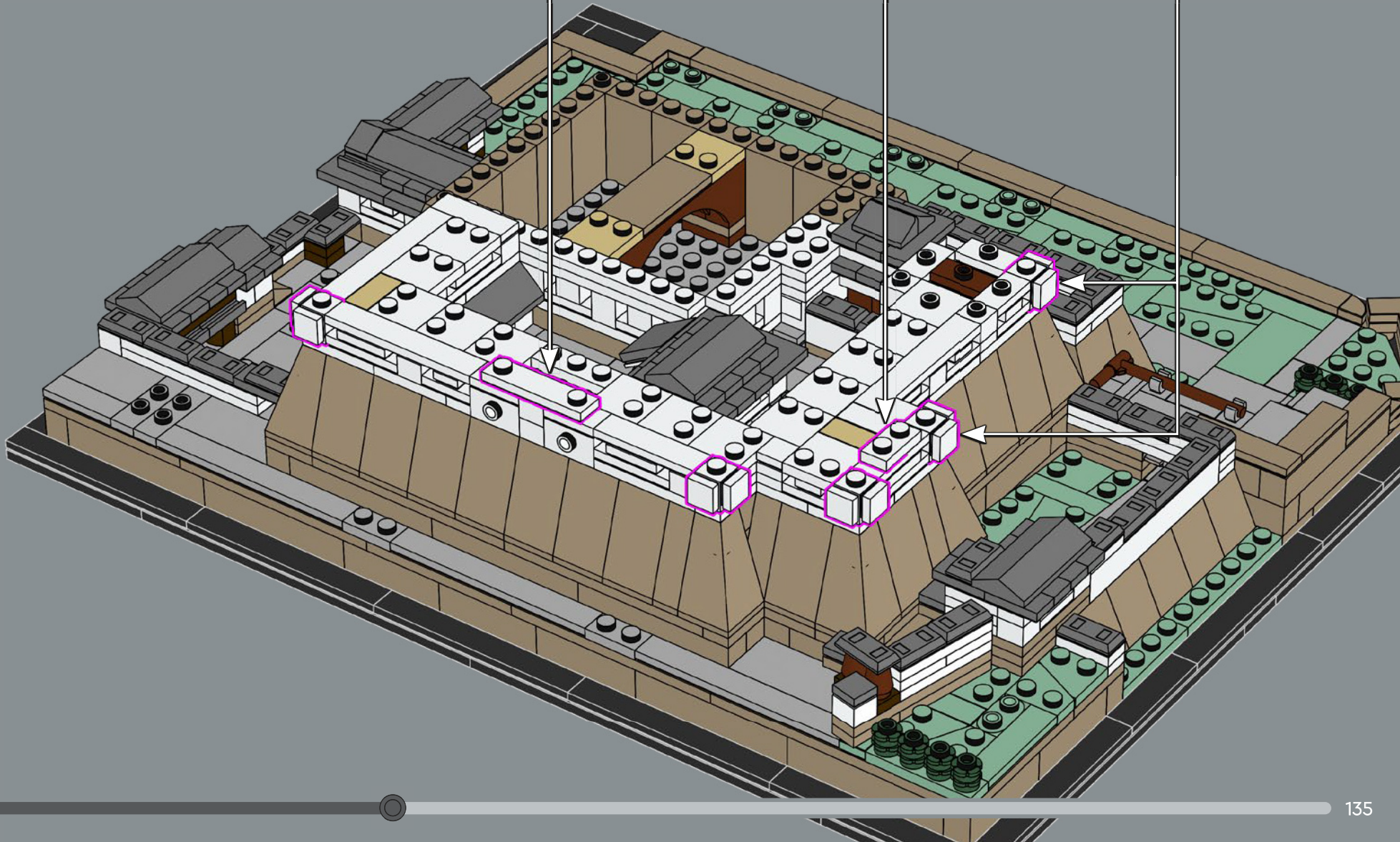
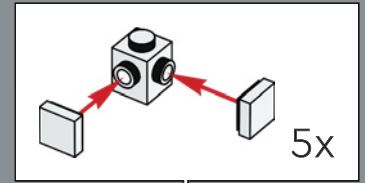
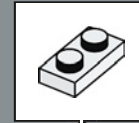
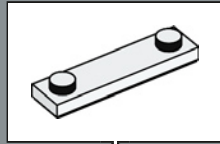

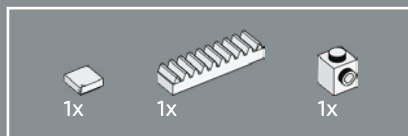

194

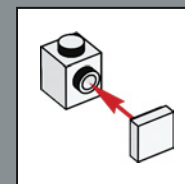
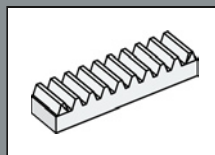

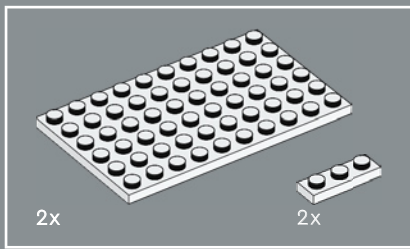

195

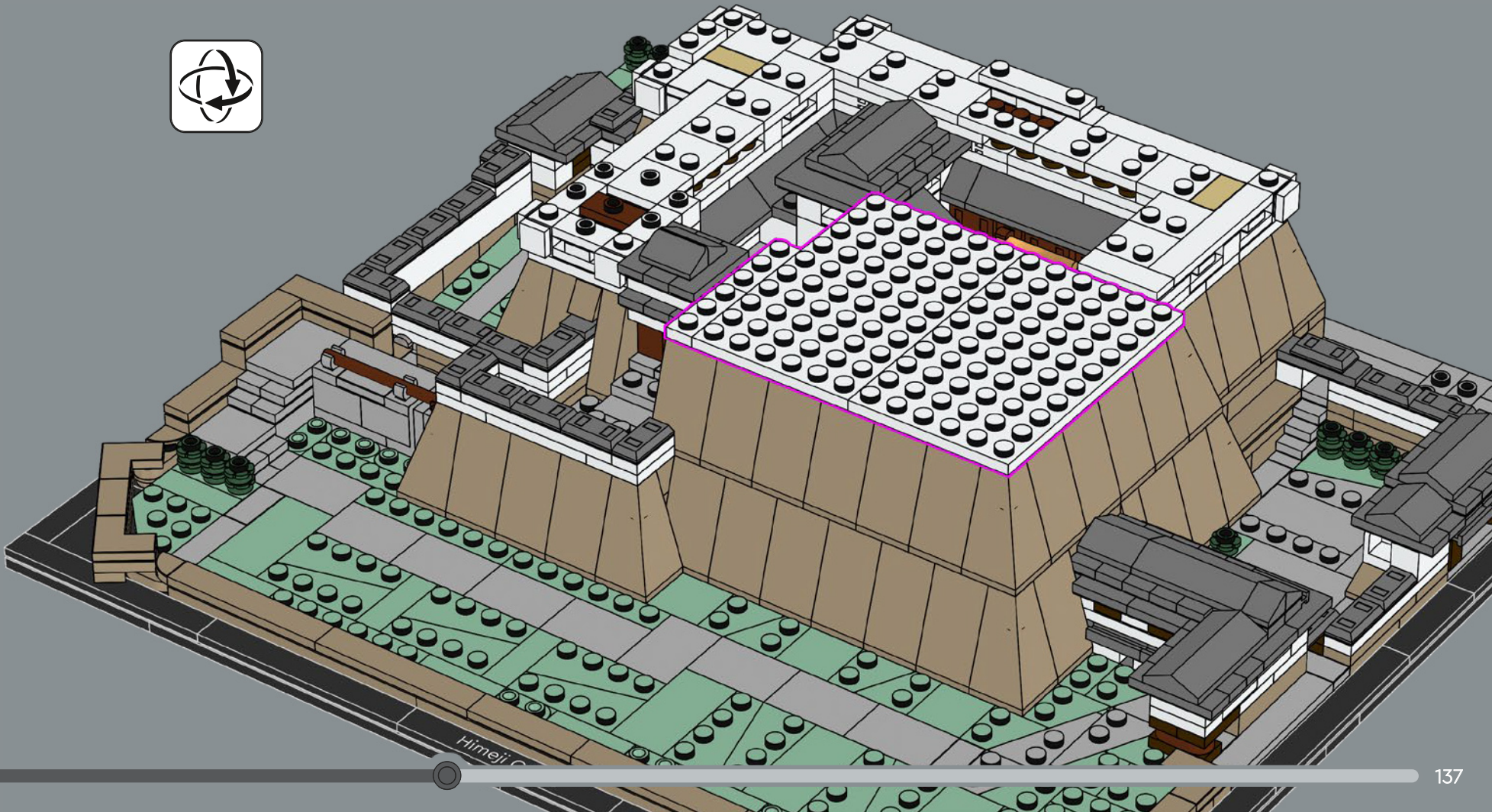

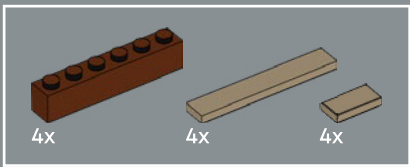

196

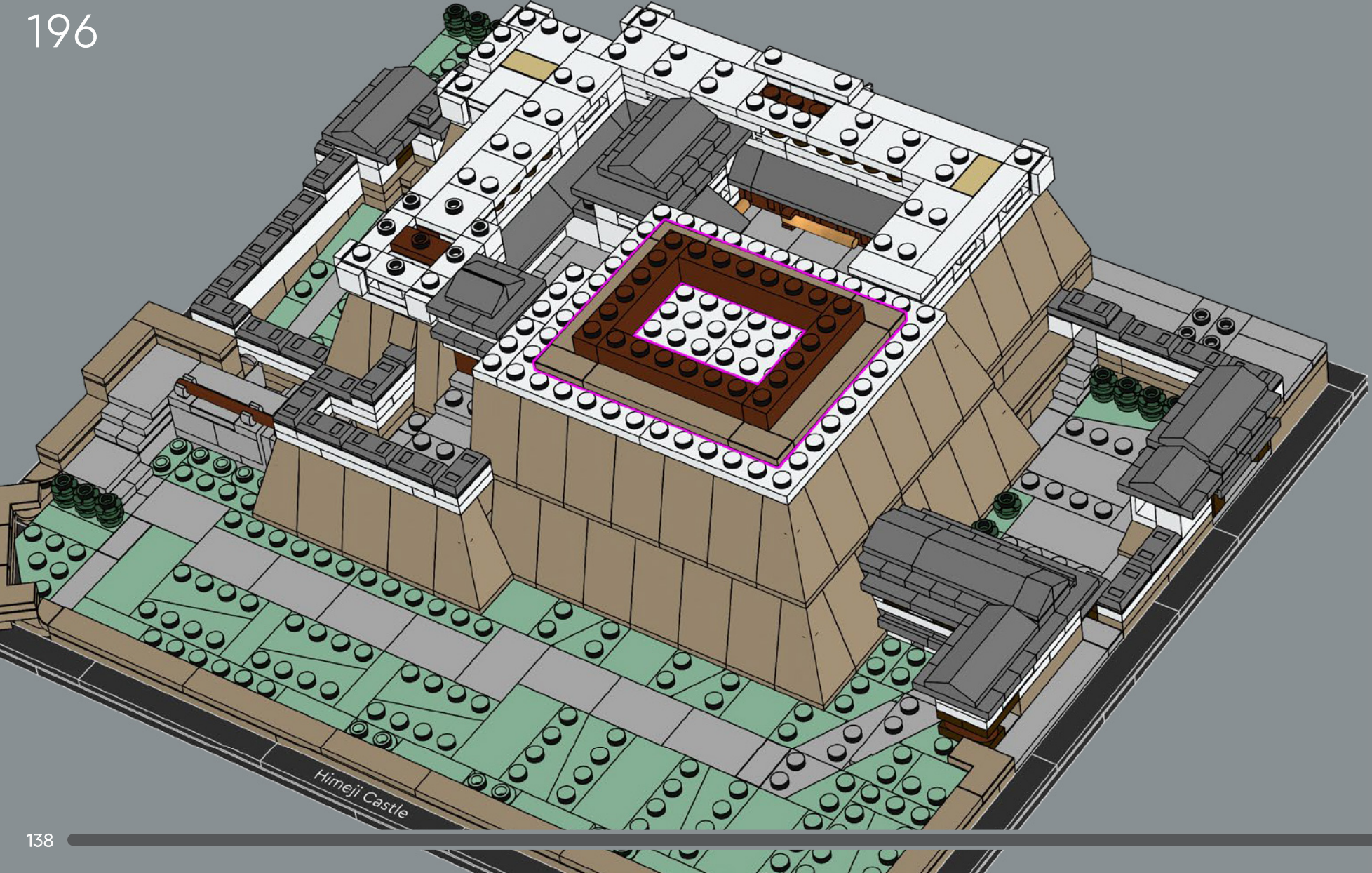

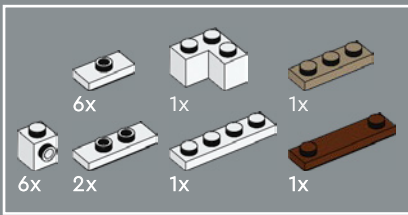

197

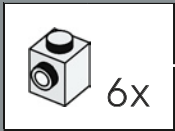
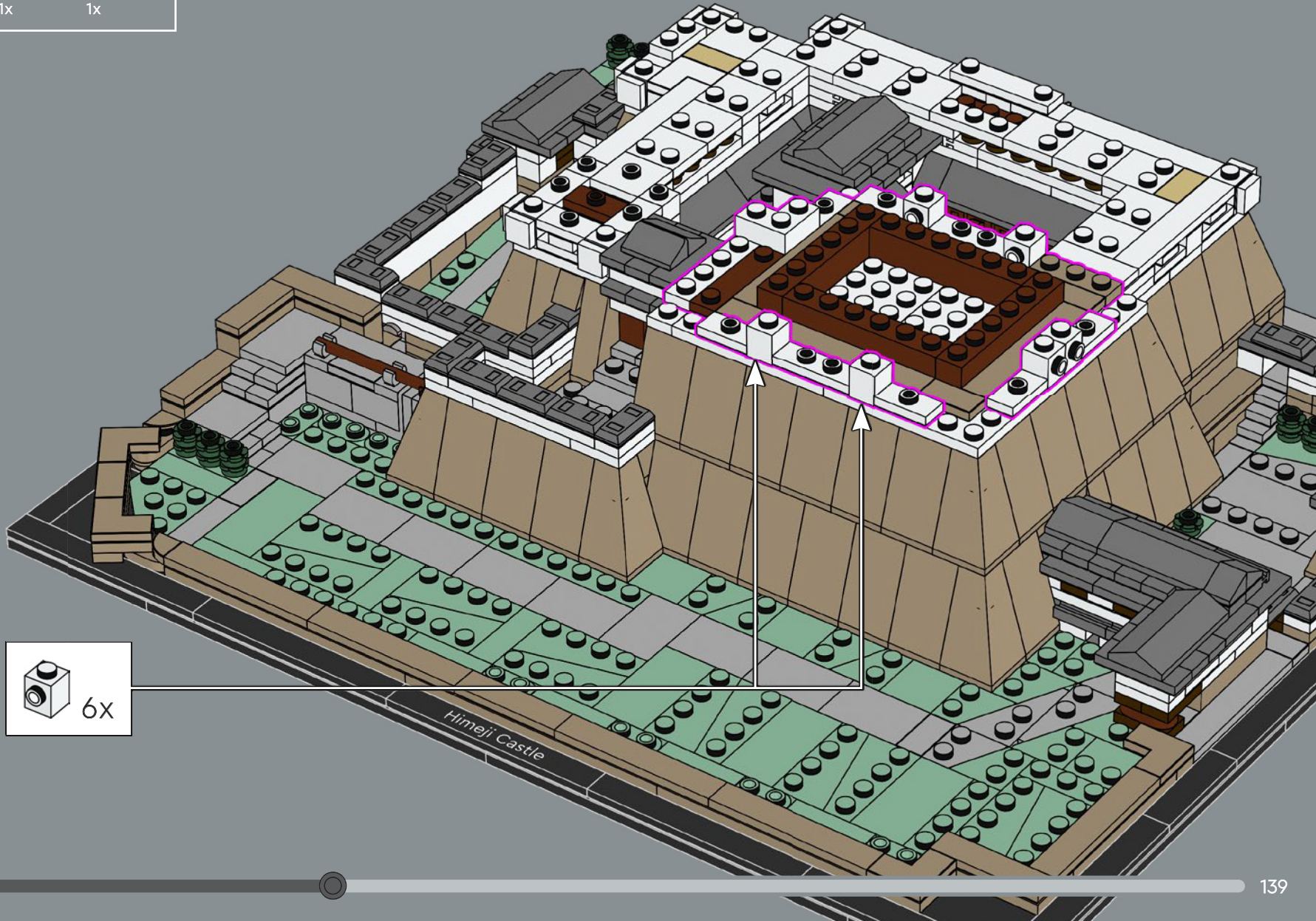

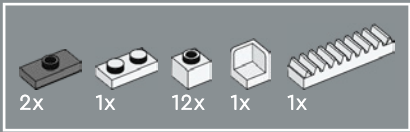

198

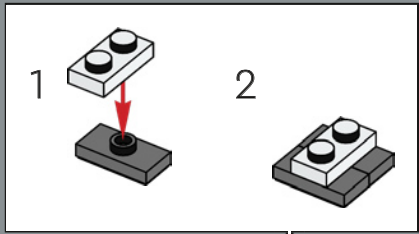

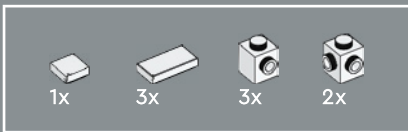

199

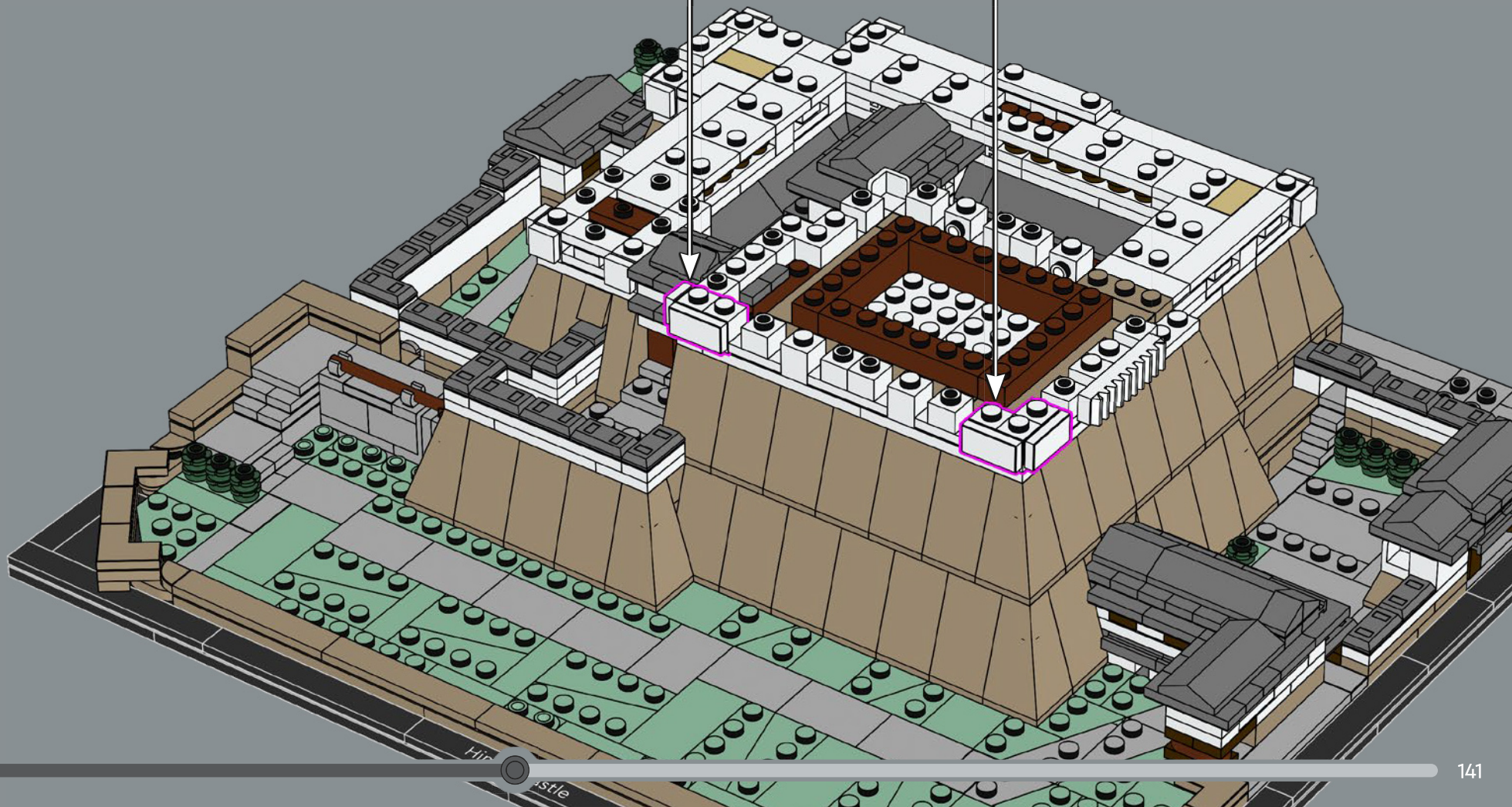
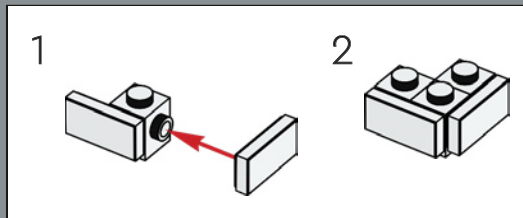
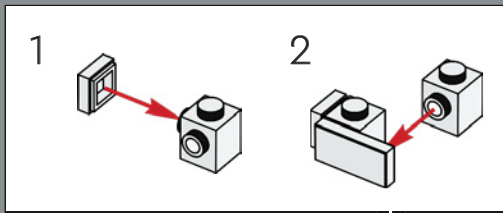

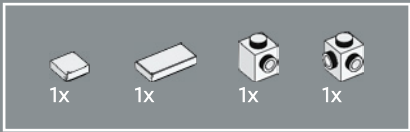

200

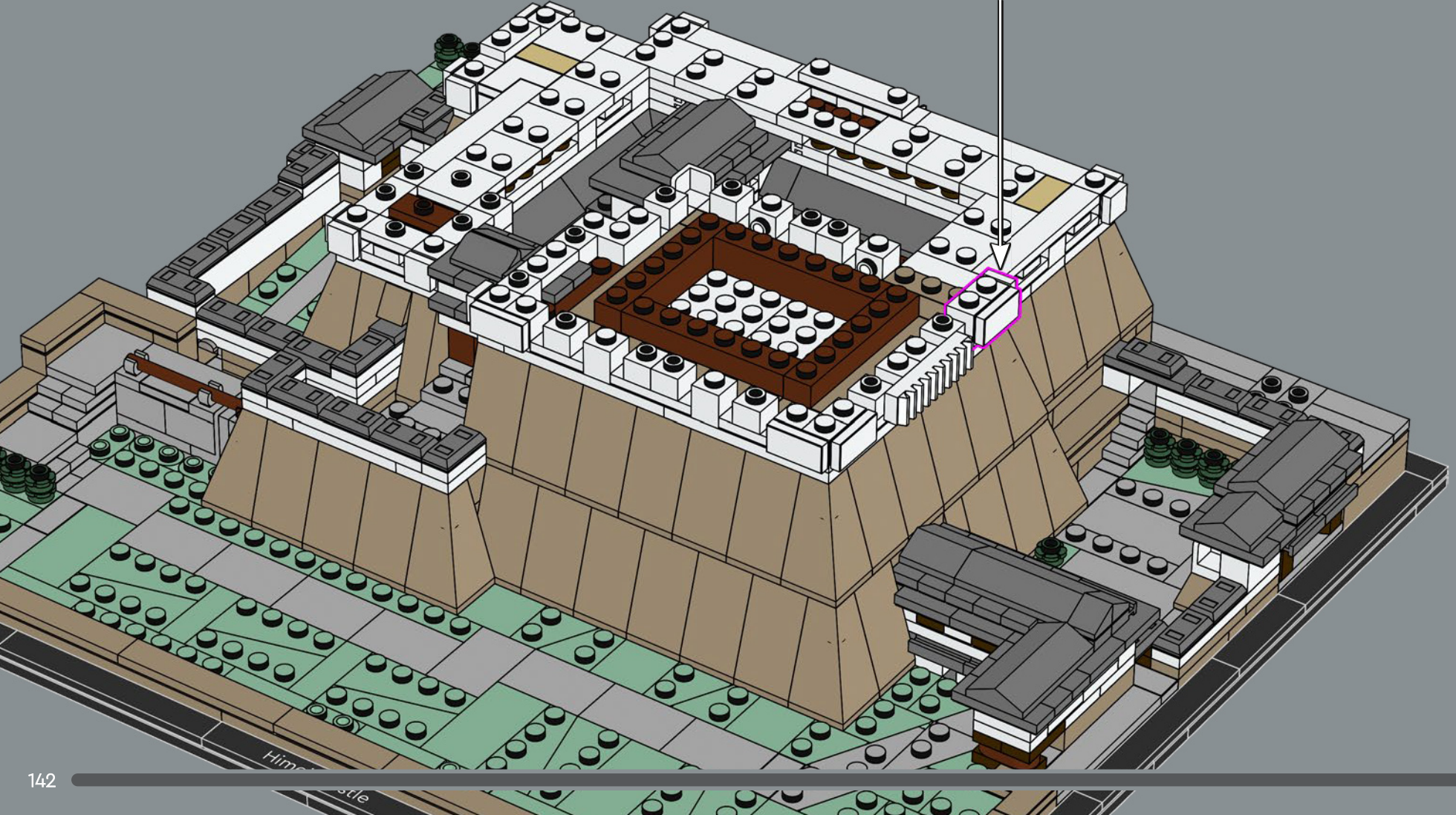
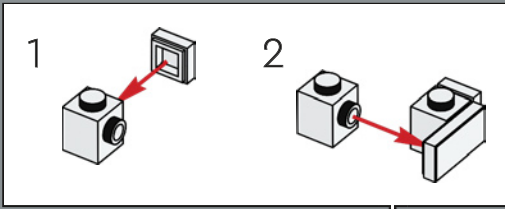

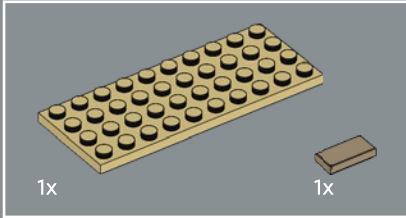
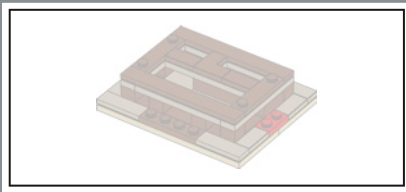

201

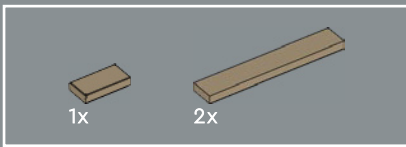
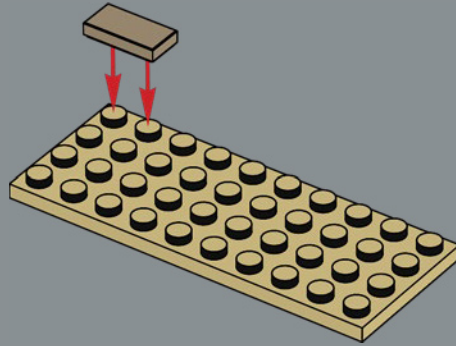

202

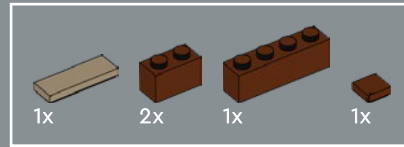
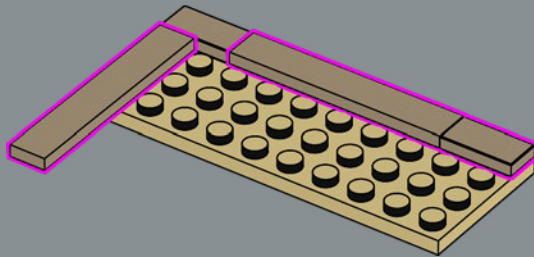

203

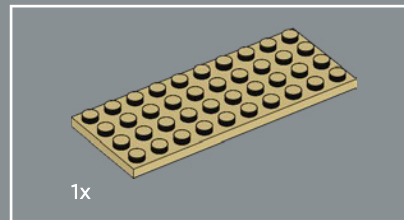
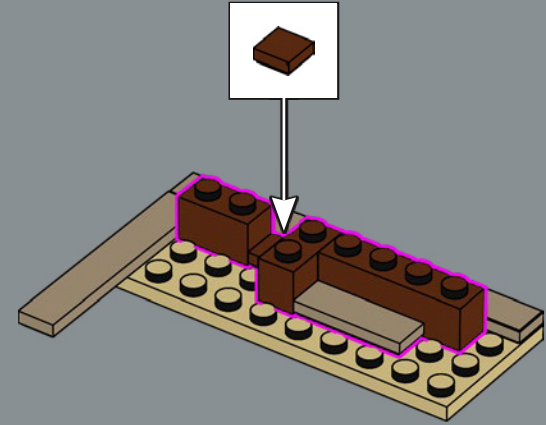

204

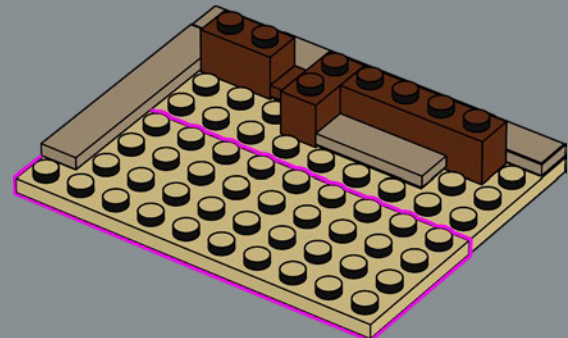

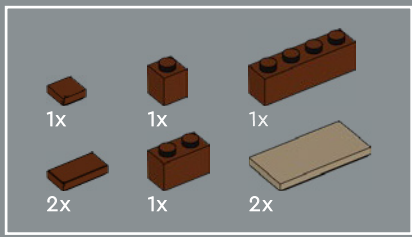

205

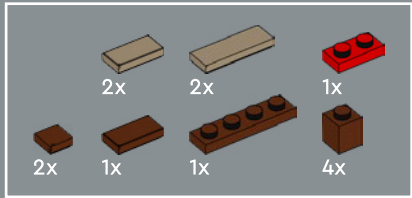
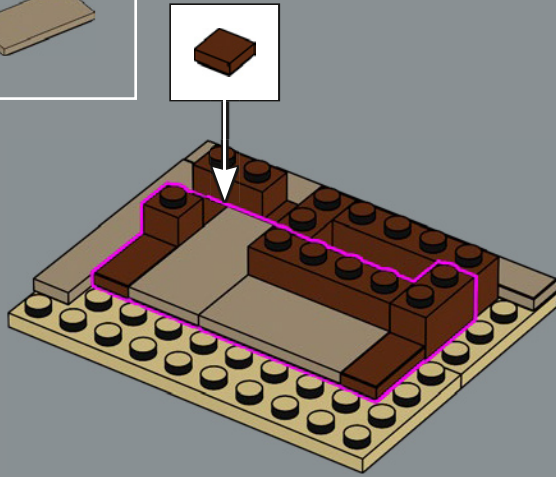

206

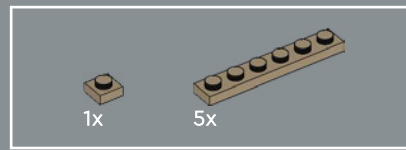
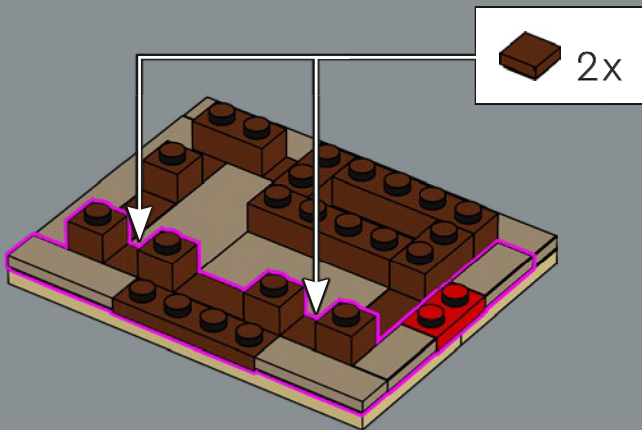

207

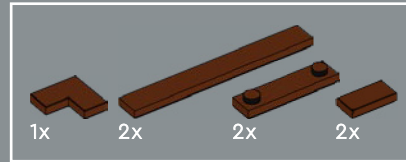
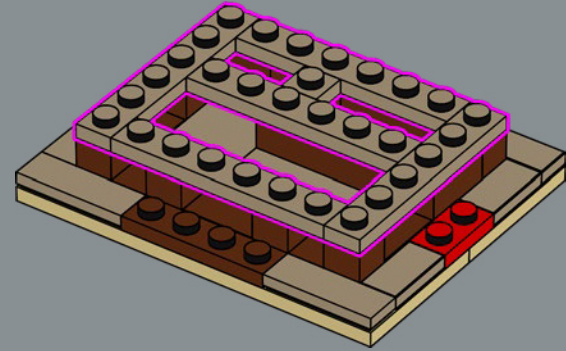

208

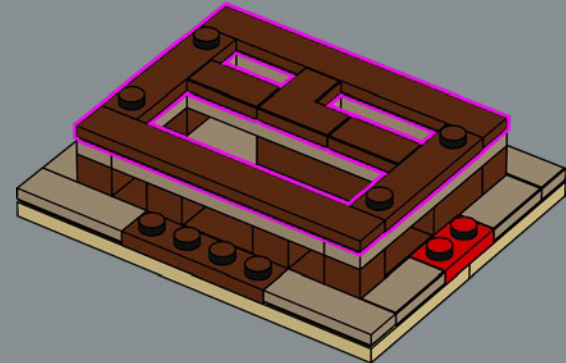

209

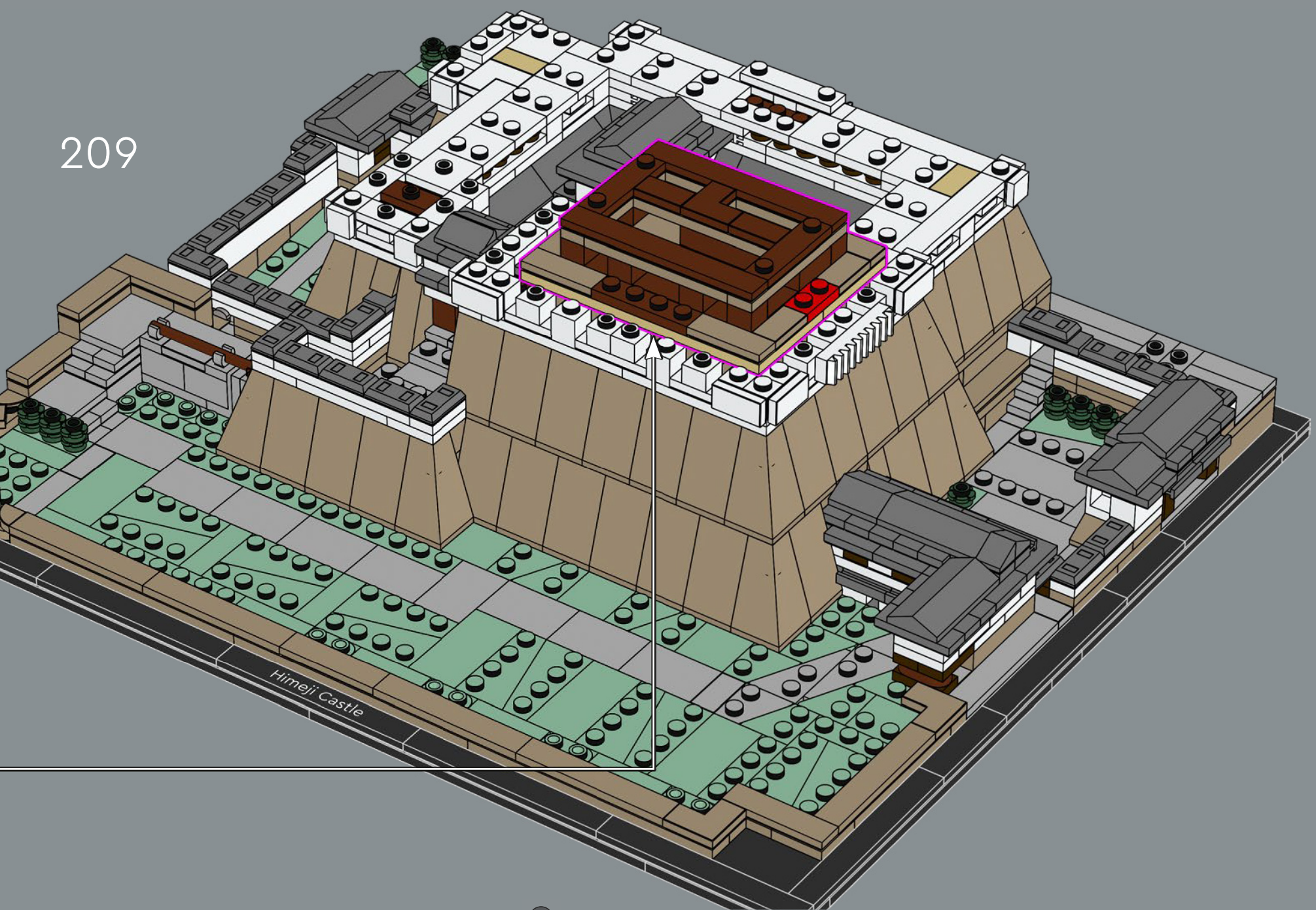

Himeji Castle

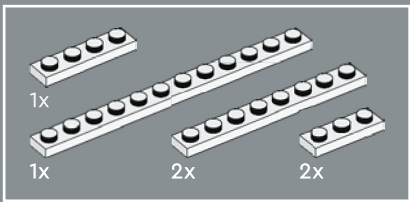

210

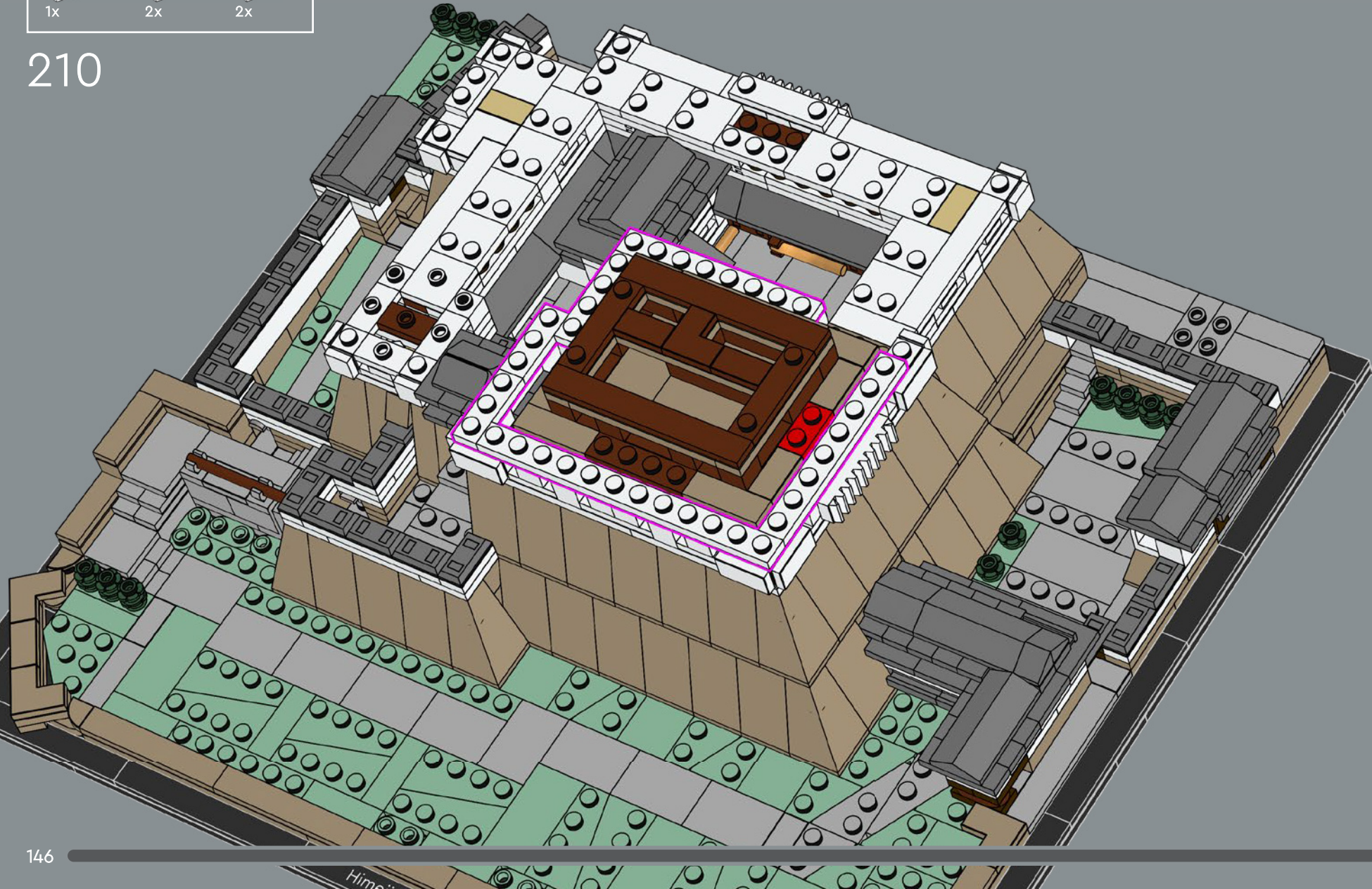

Anche se per questo set abbiamo dovuto rispettare angoli di 90 gradi o comunque gestibili, abbiamo mantenuto alcune linee asimmetriche per onorare il design del castello originale.

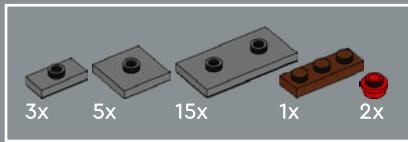

211

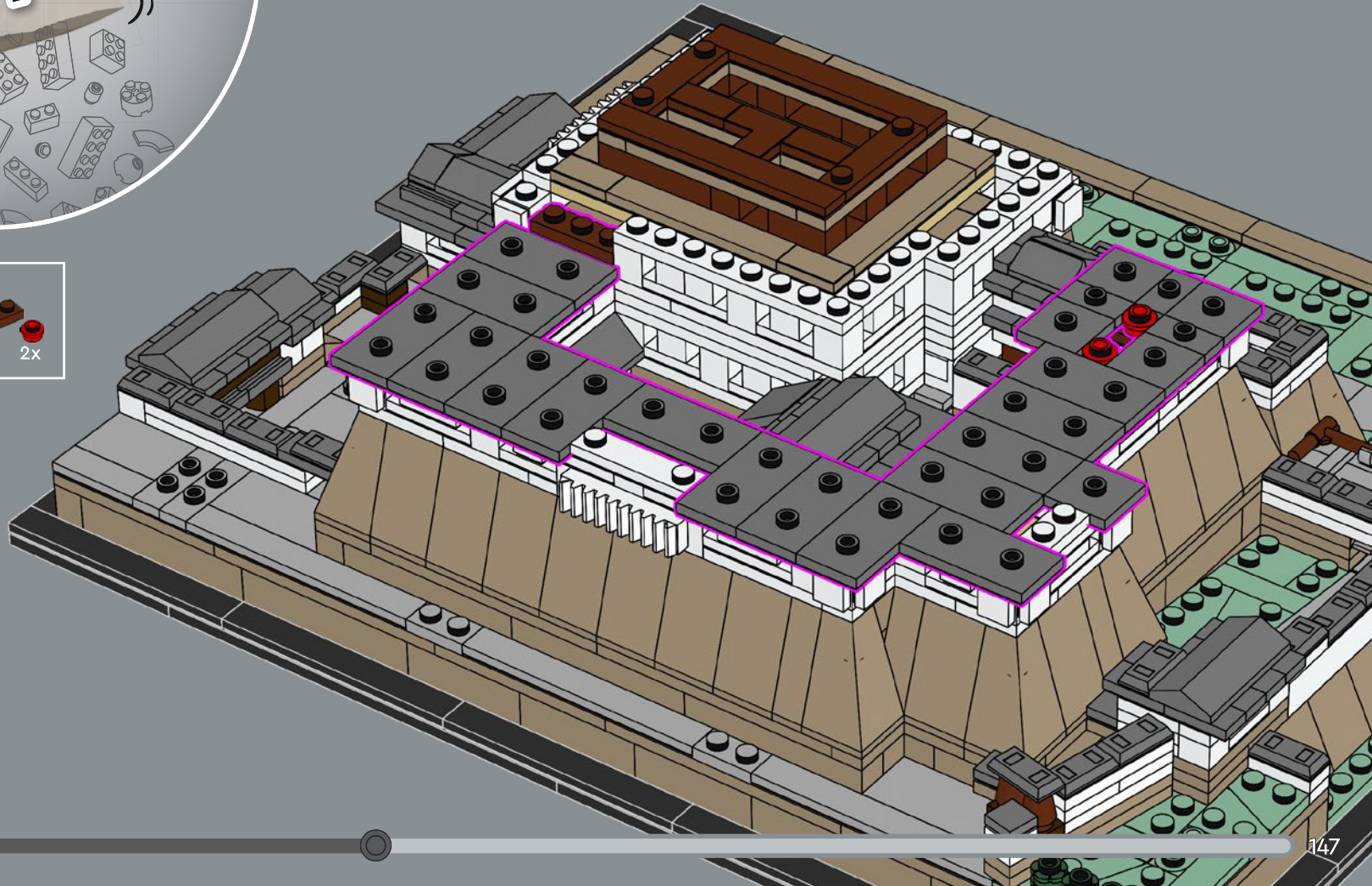

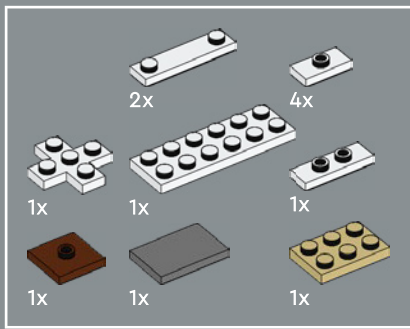

212

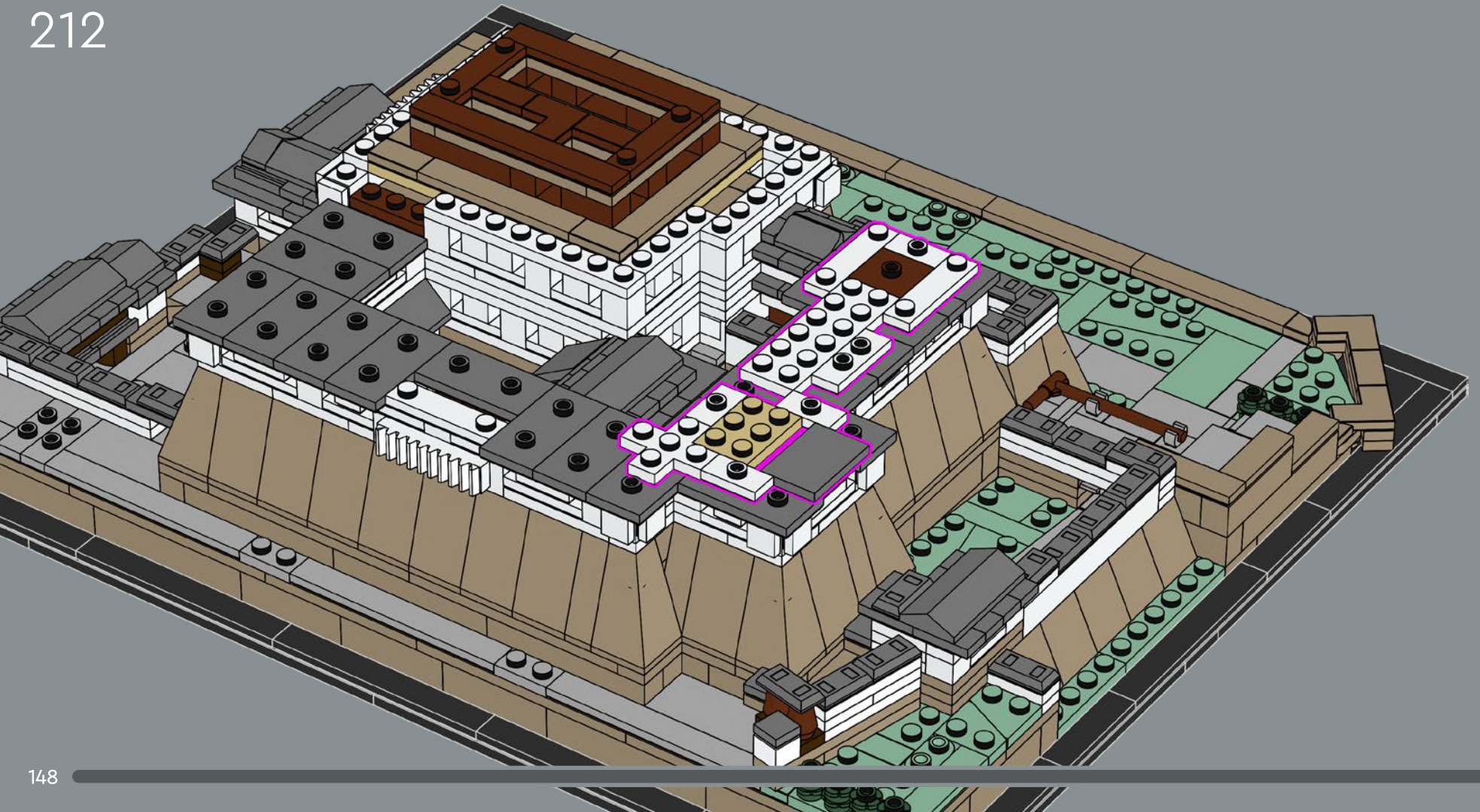

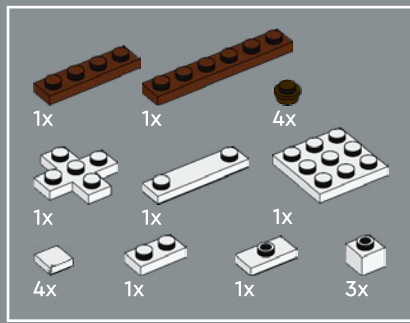

213

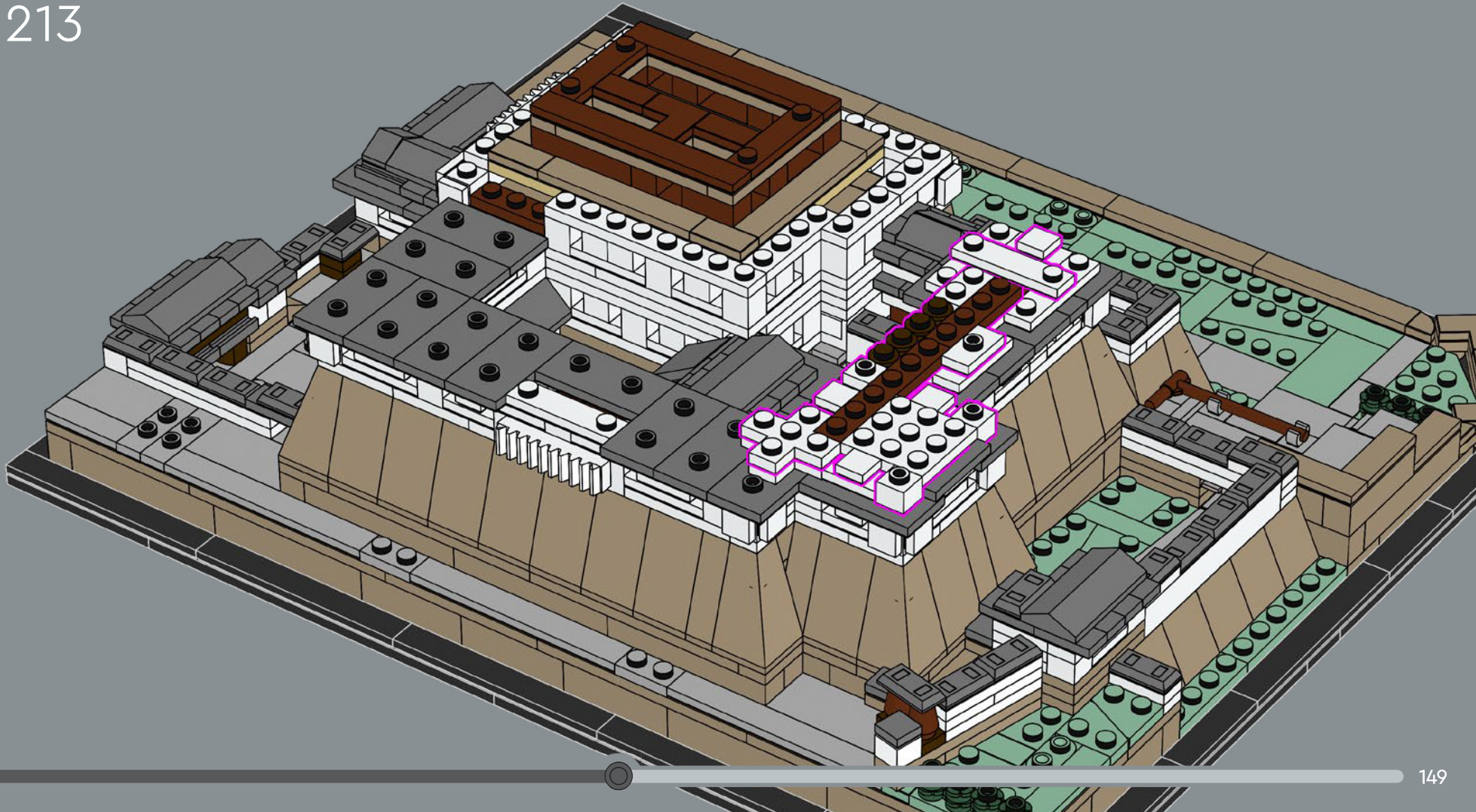

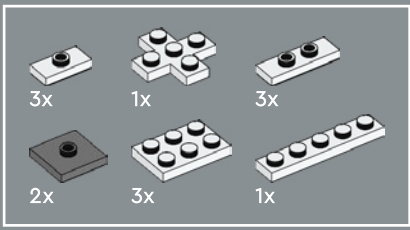

214

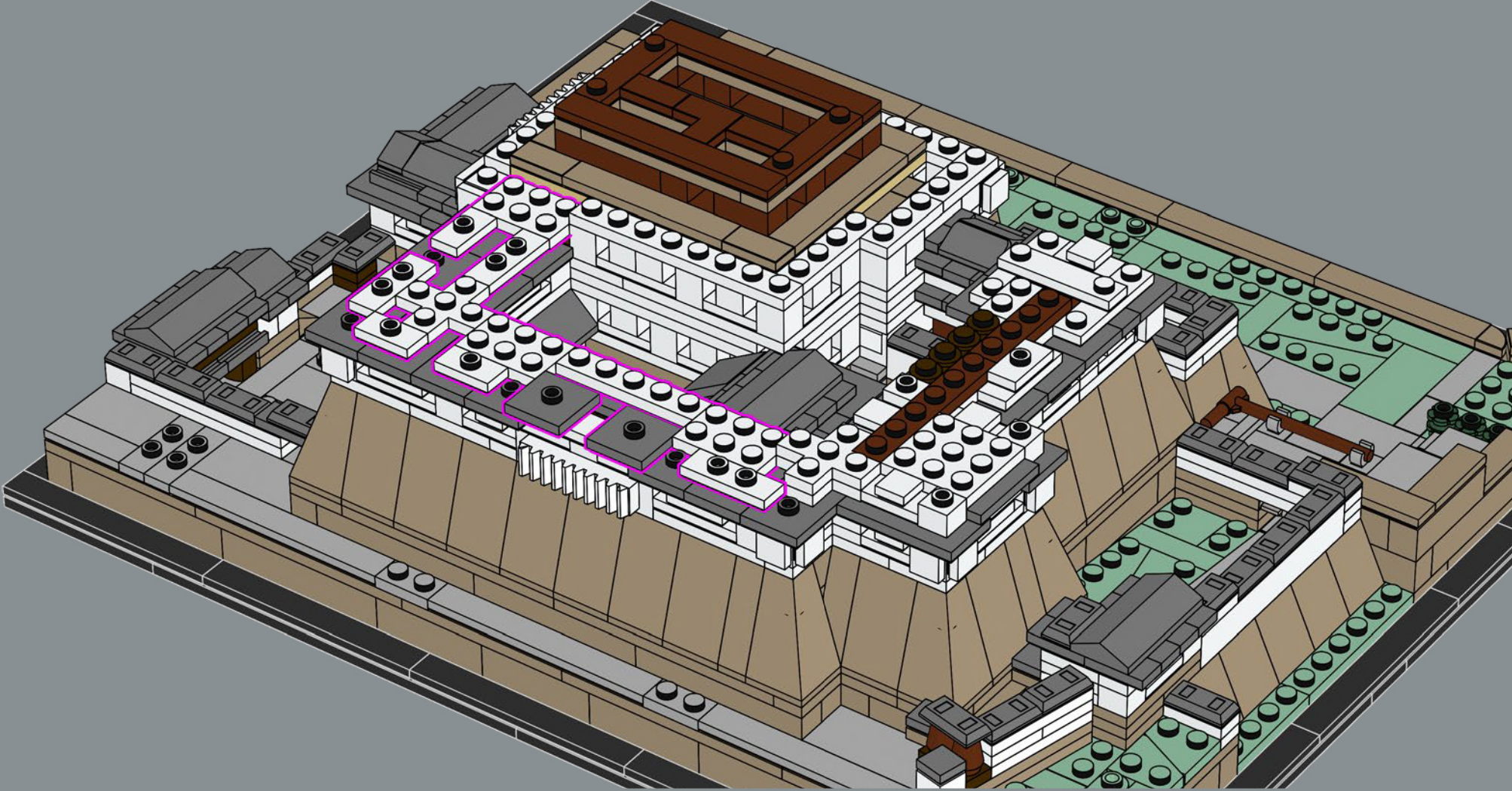

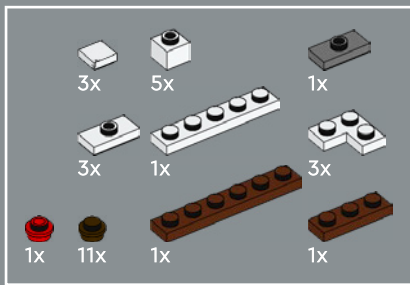

215

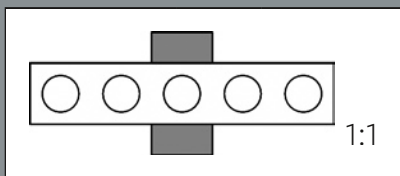
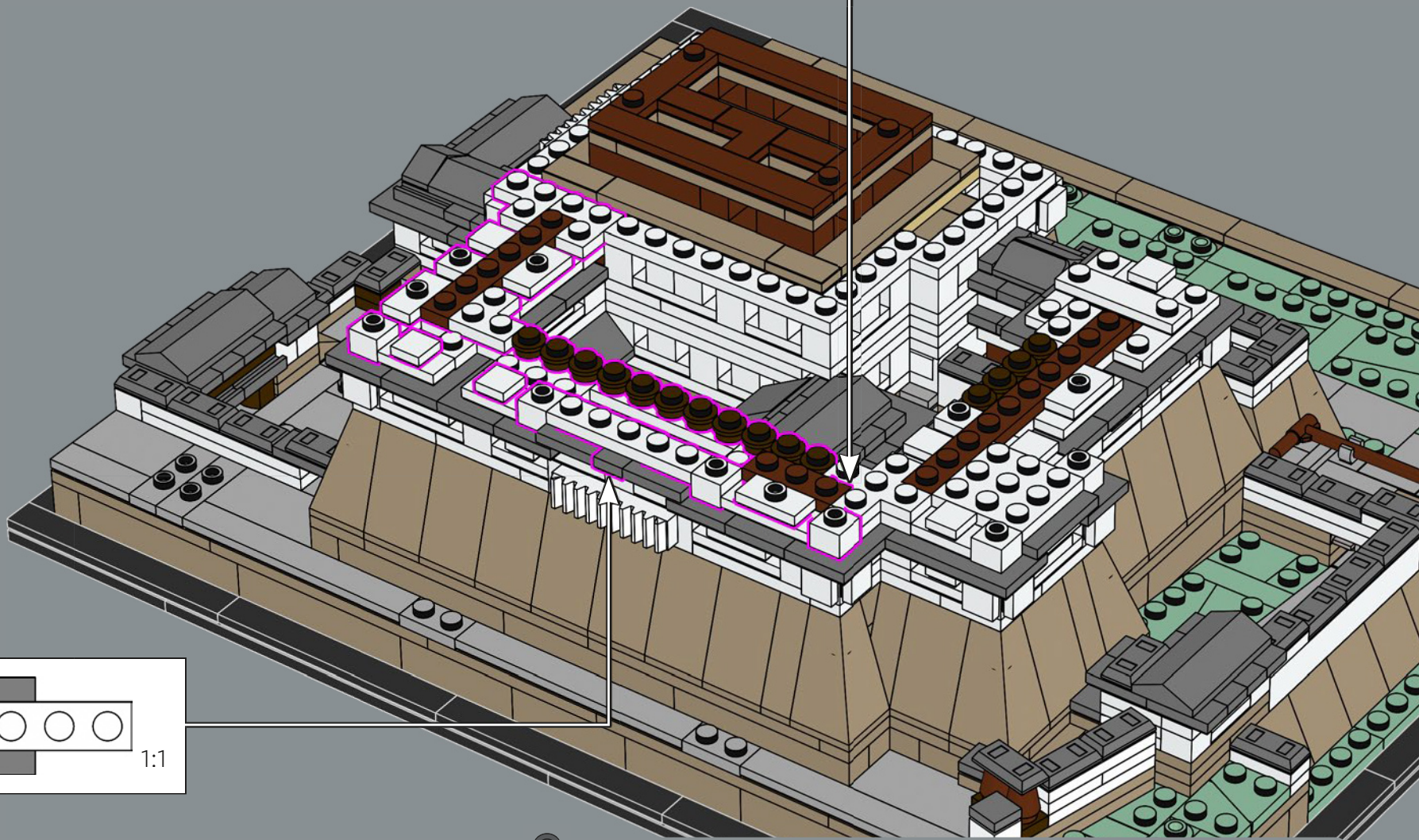
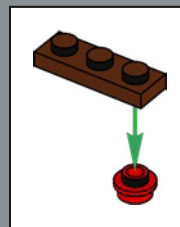

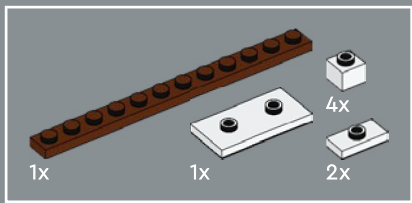

216

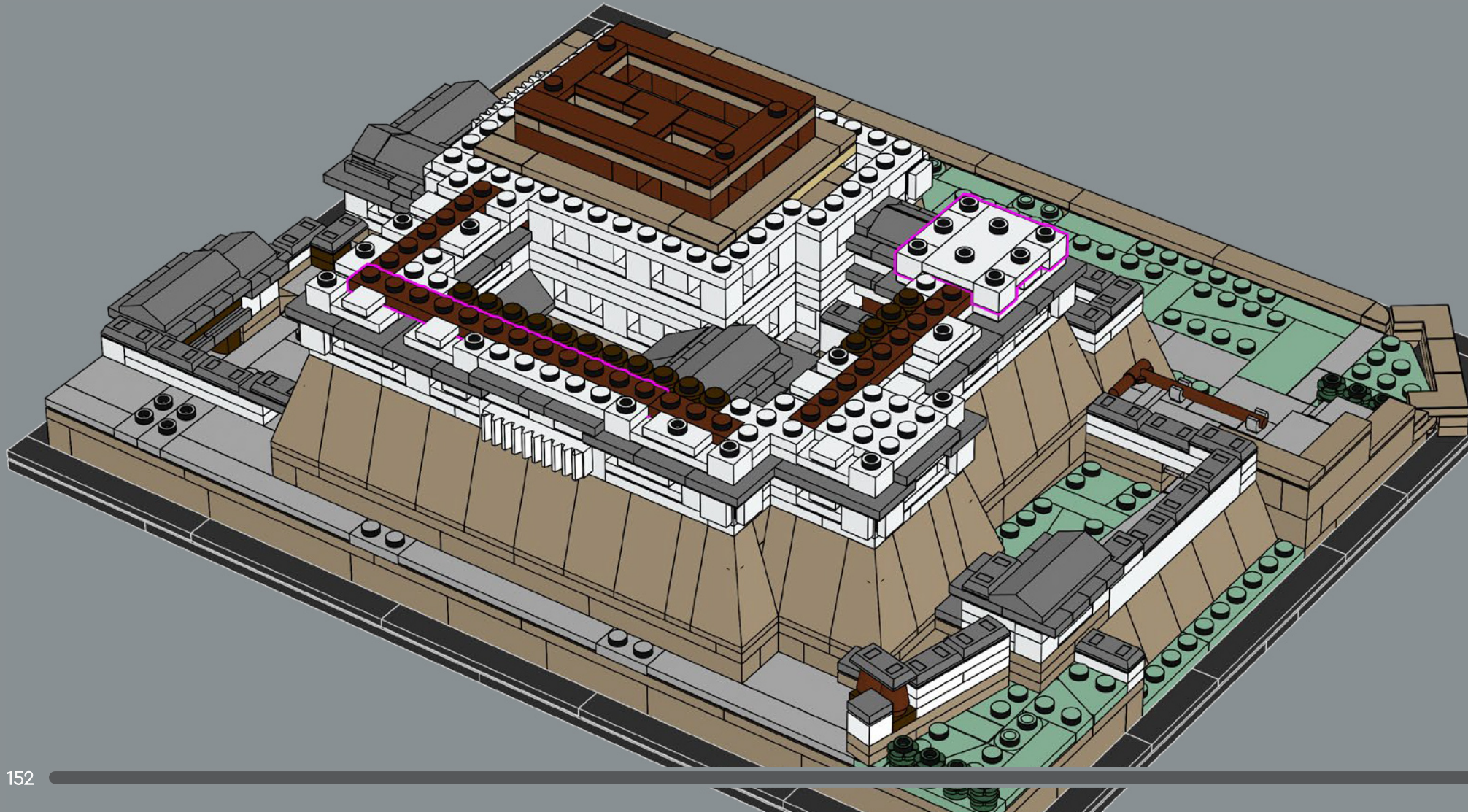

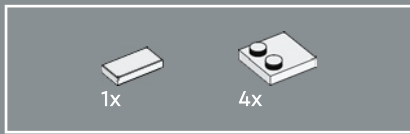

217

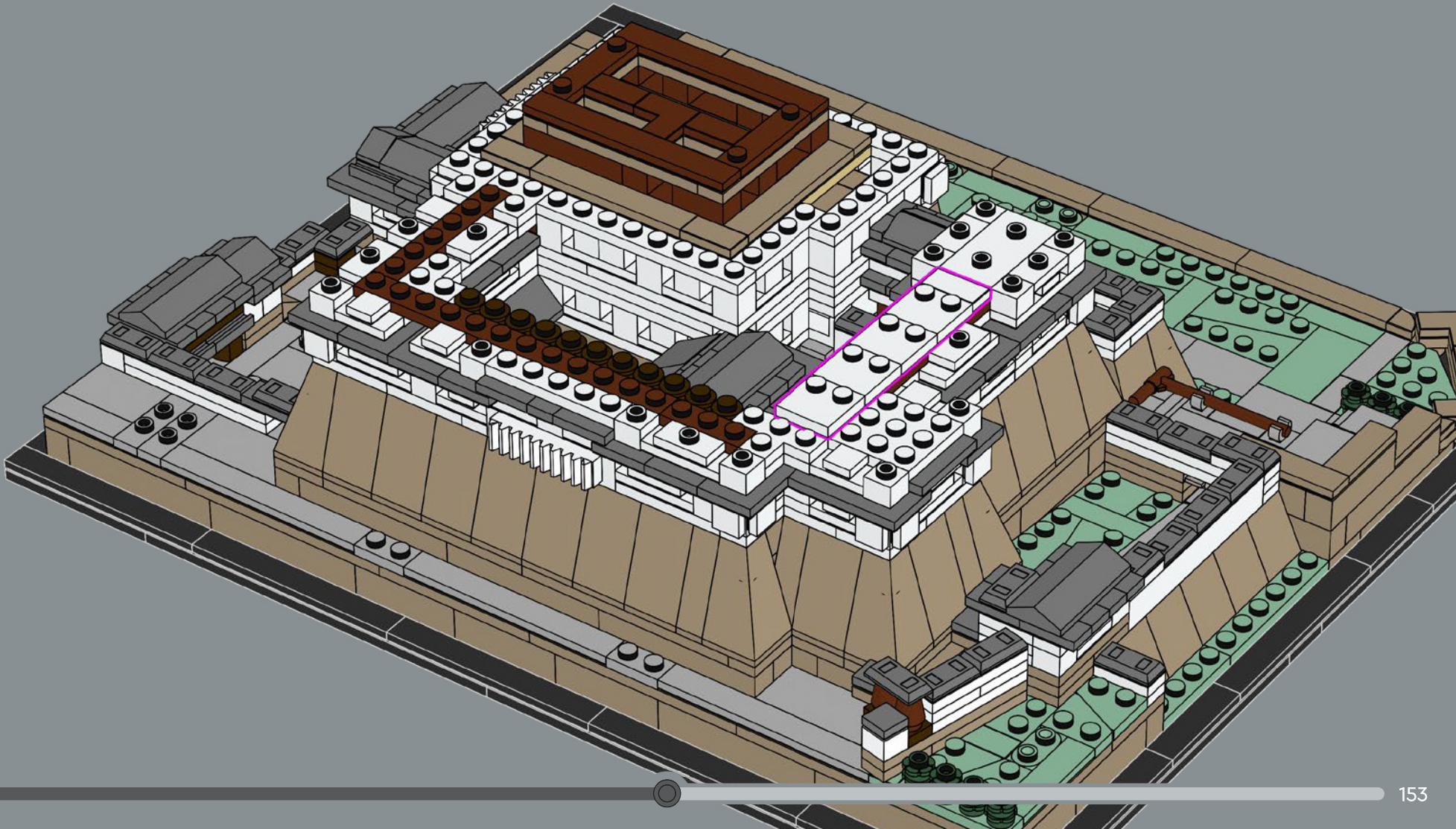

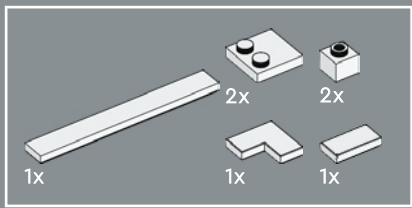

218

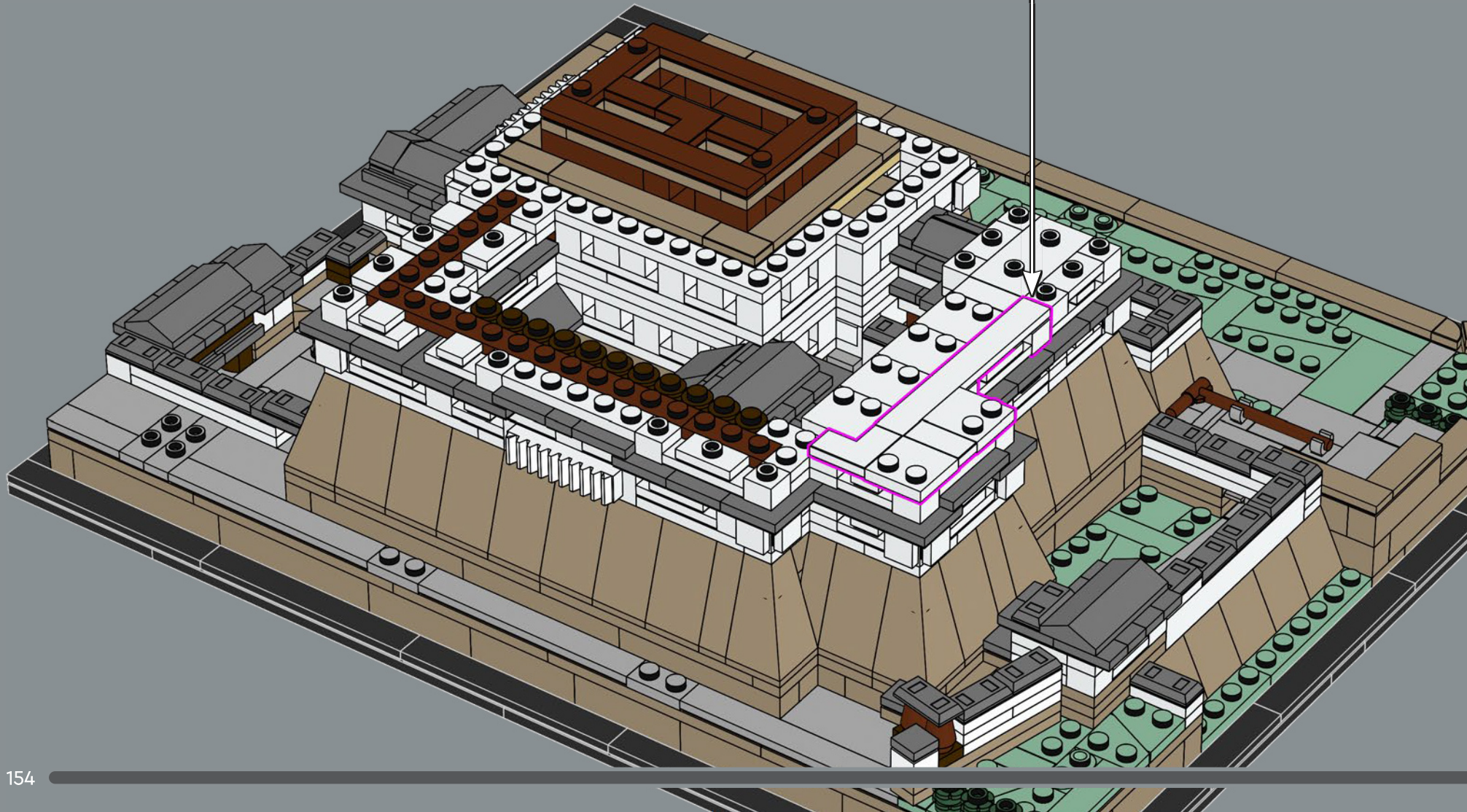
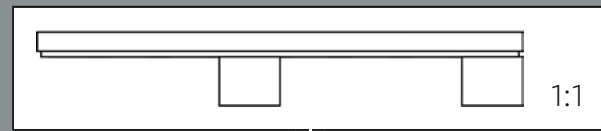

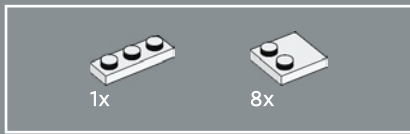

219

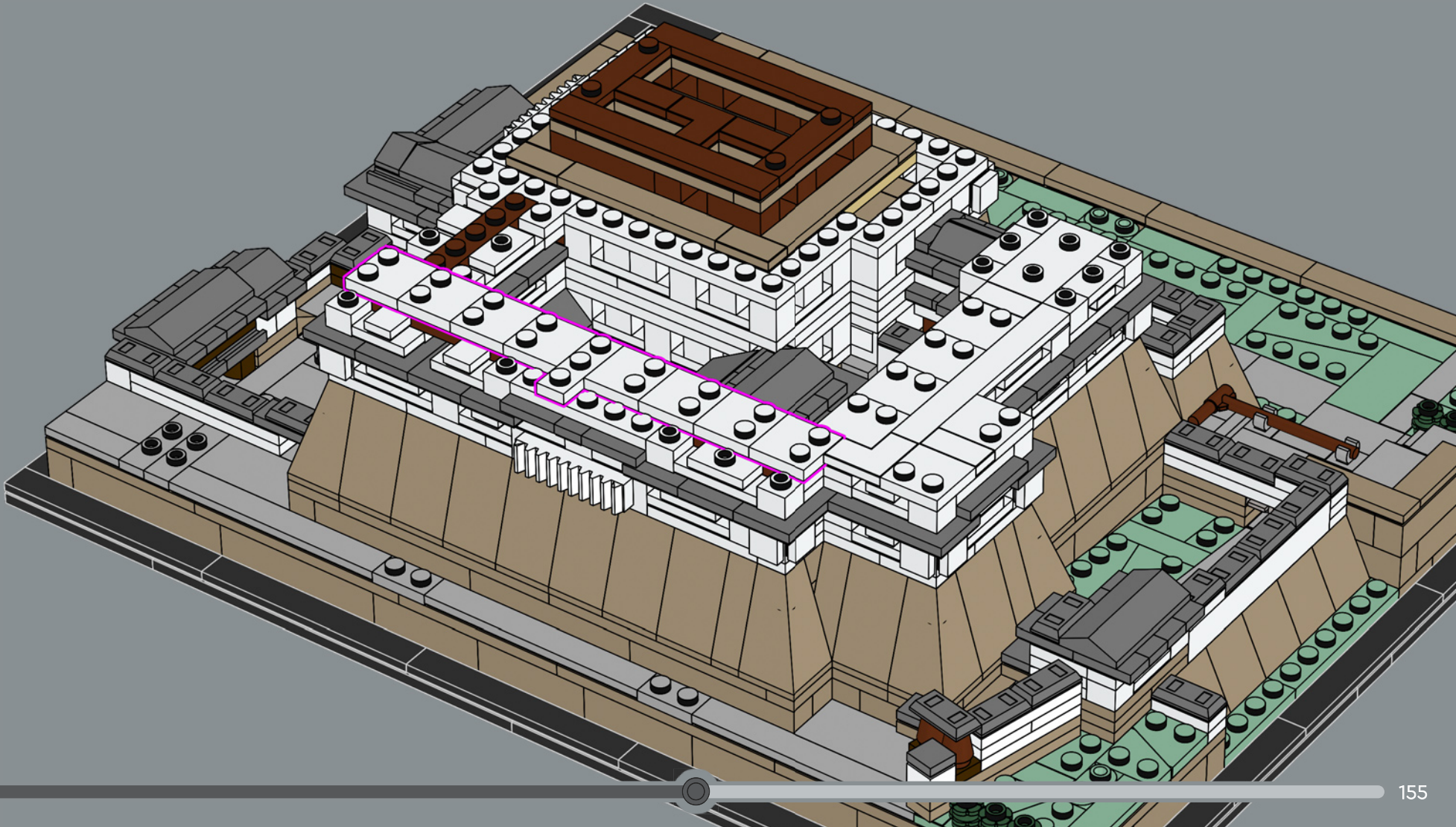

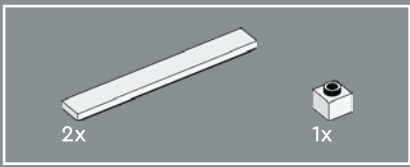

220

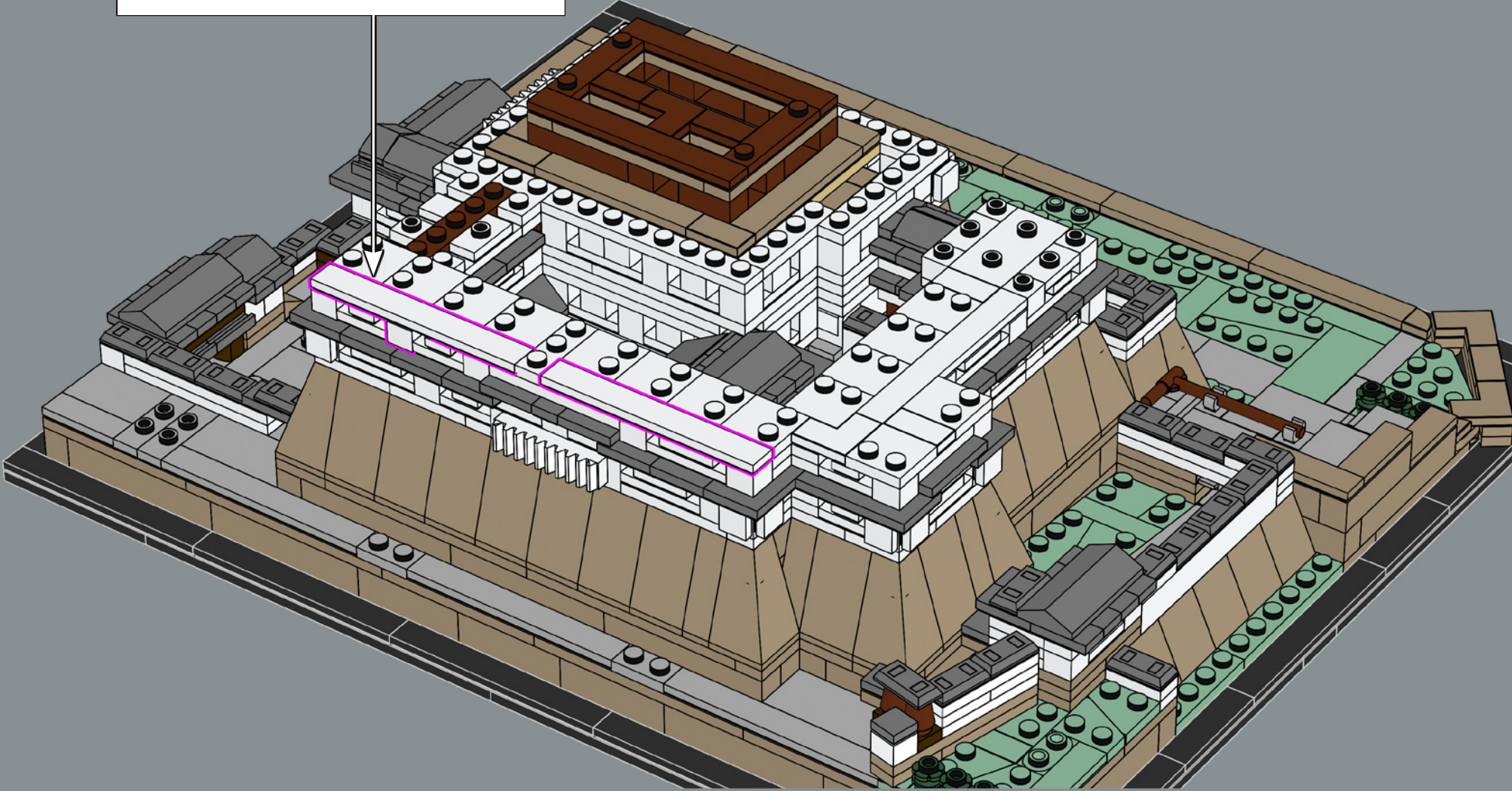

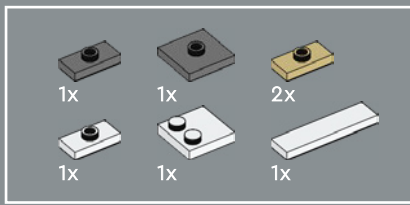

221

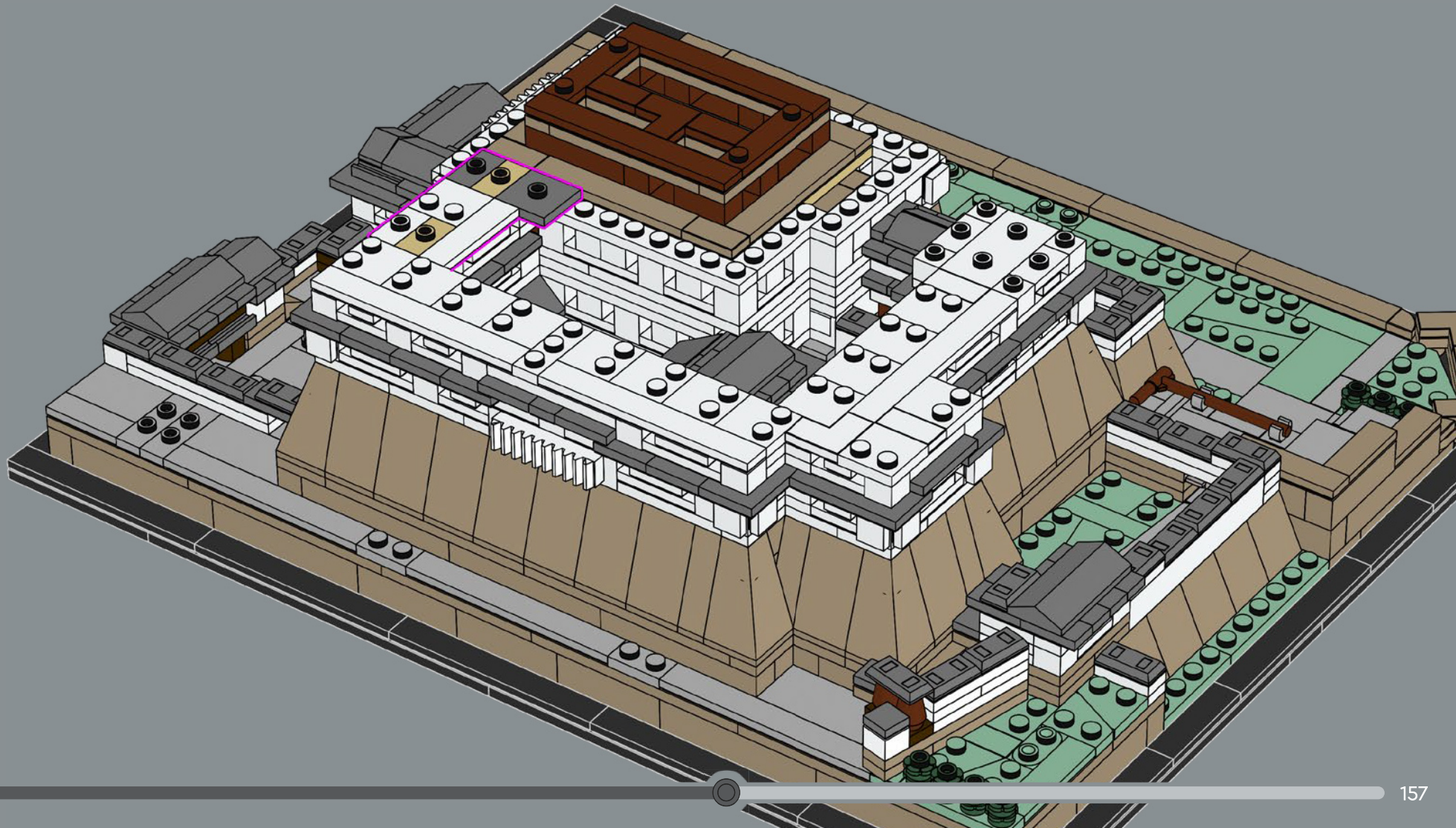

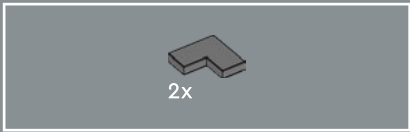

222

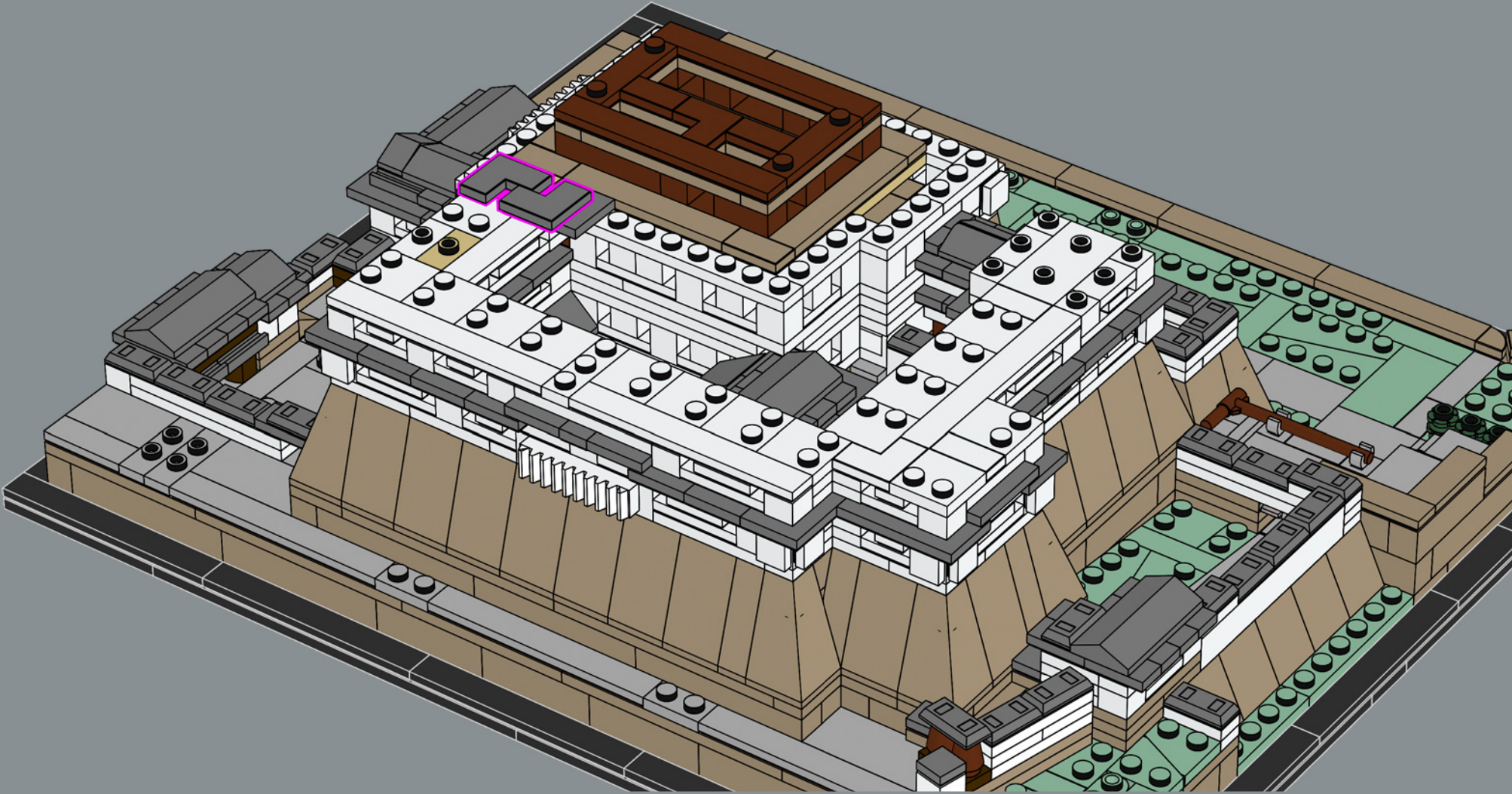

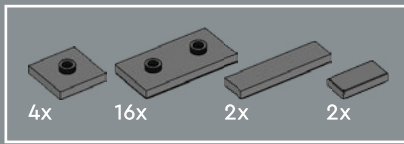

223

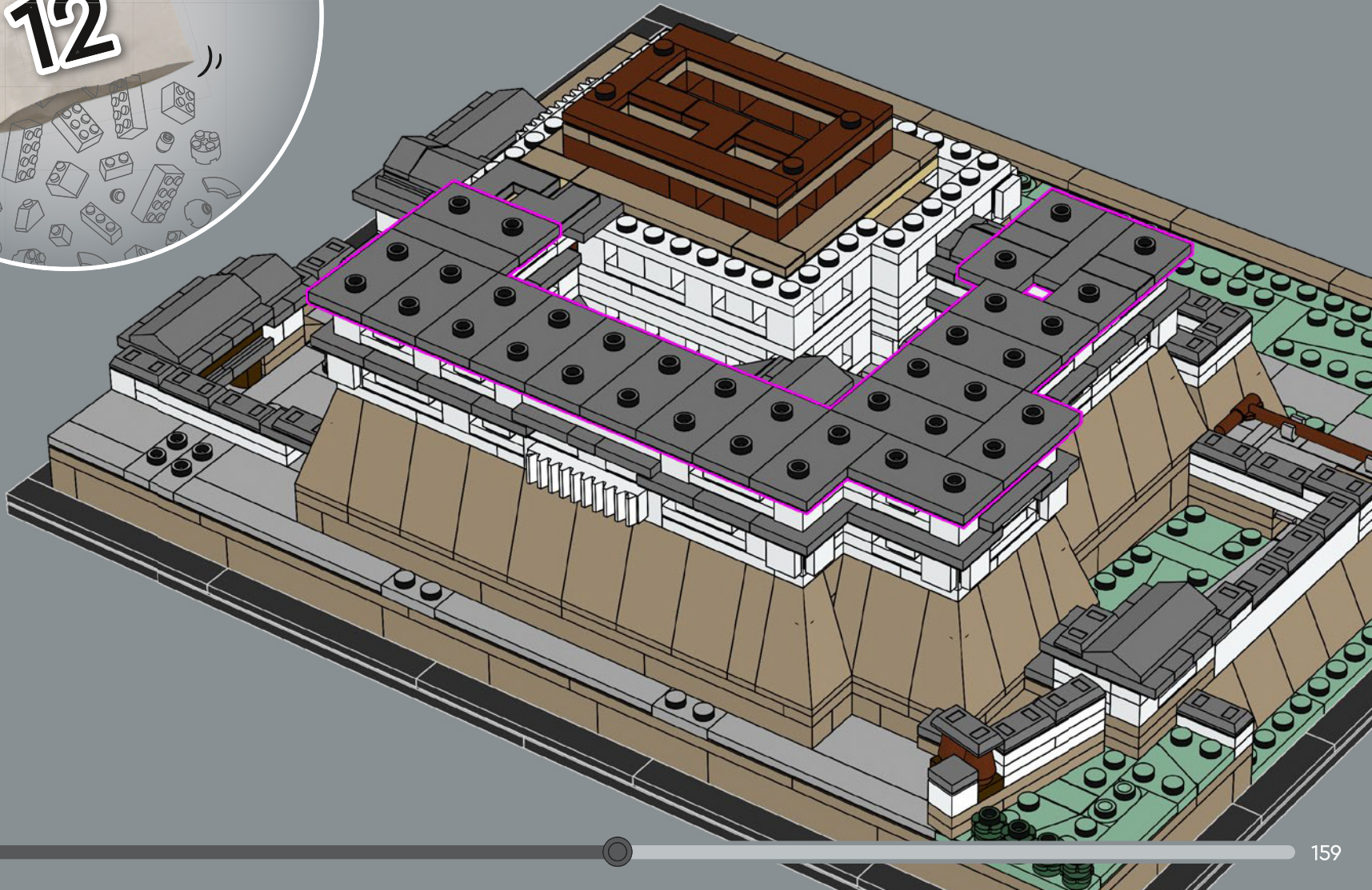

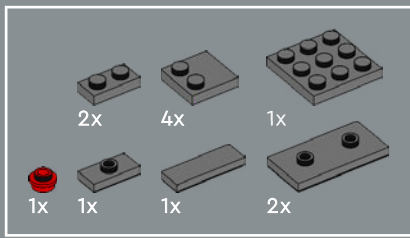

224

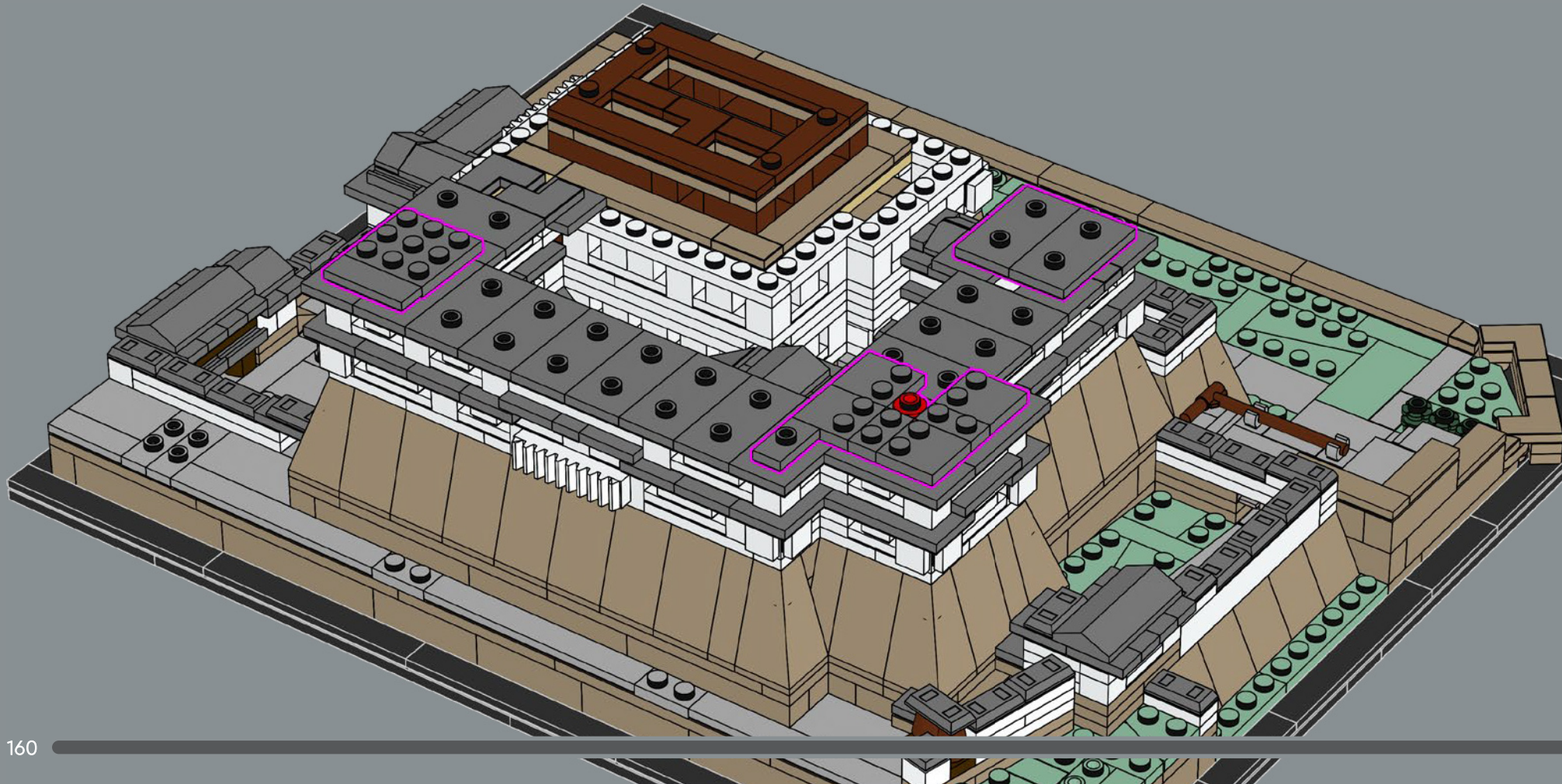

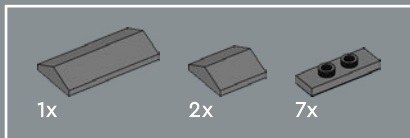

225

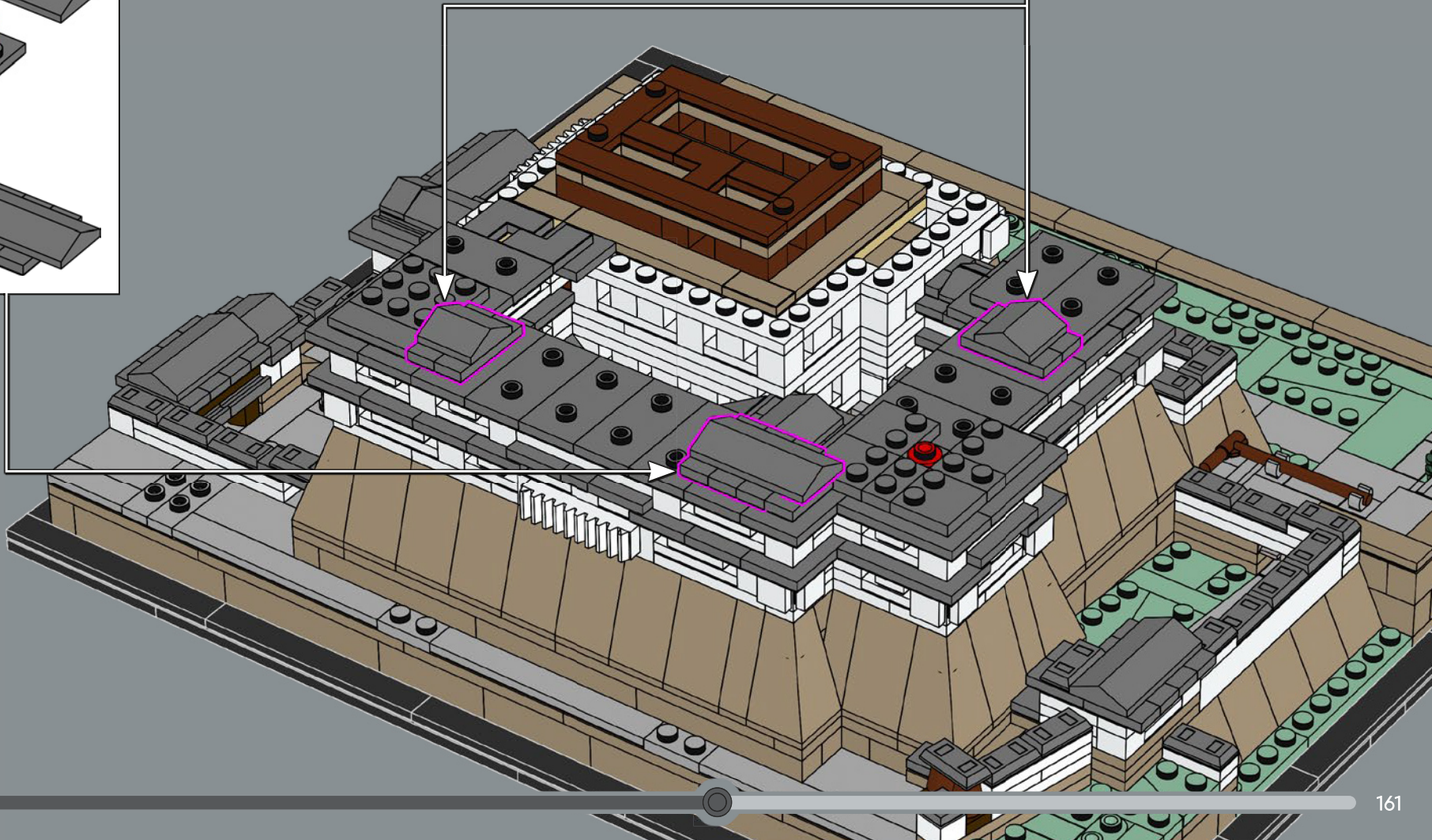
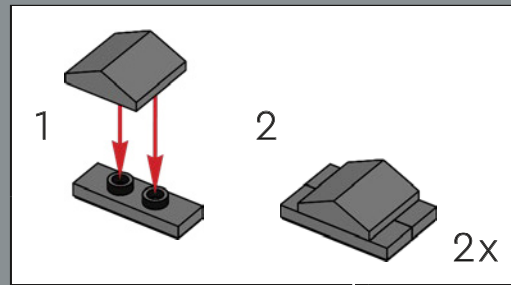
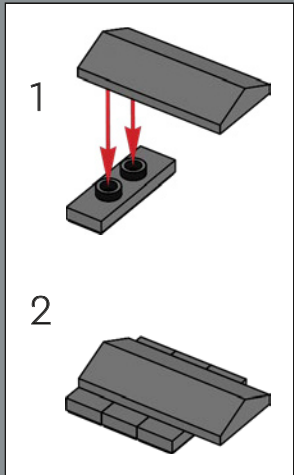

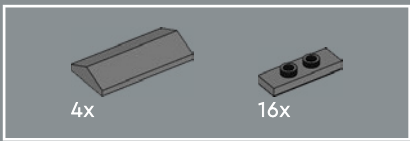

226

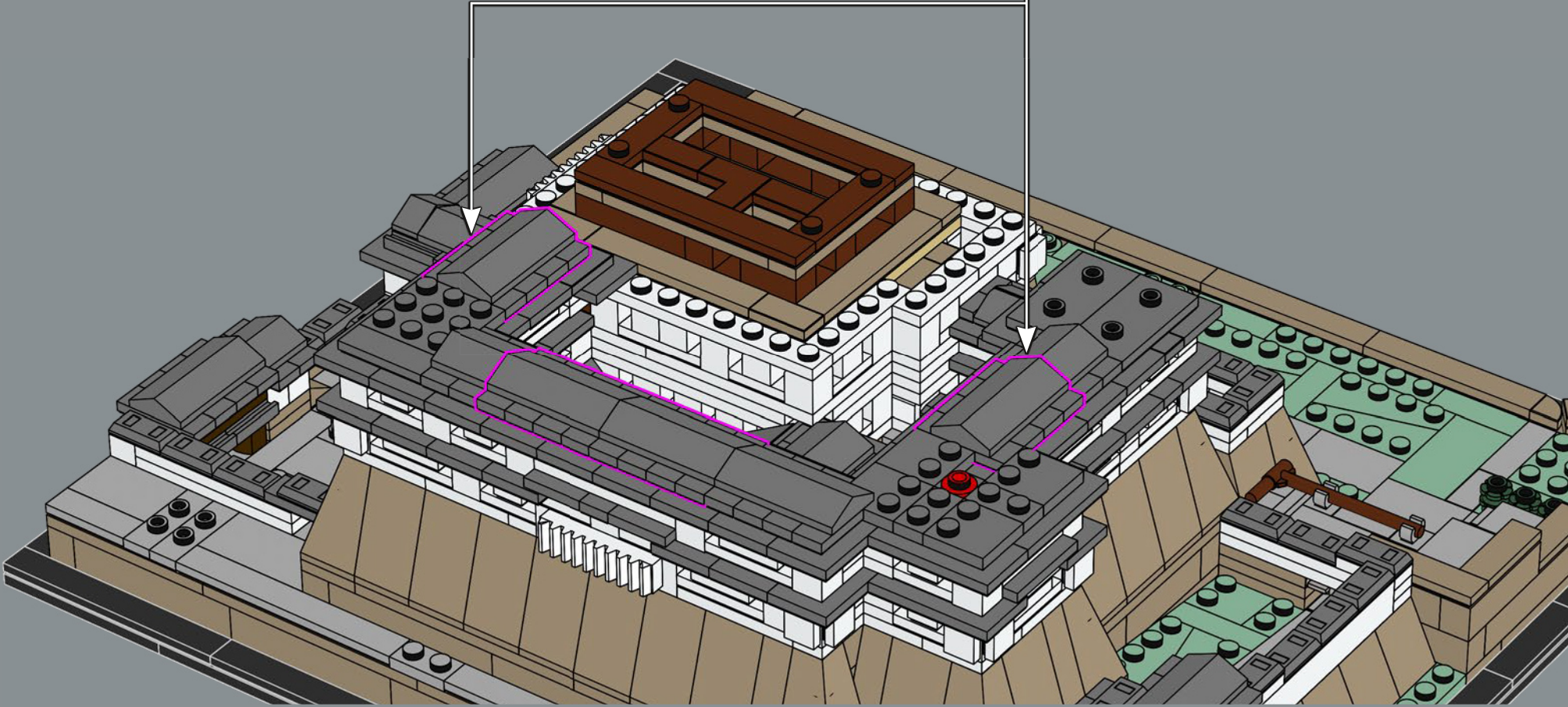
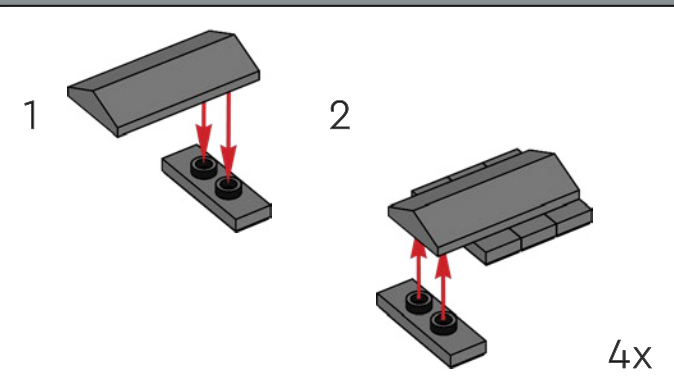

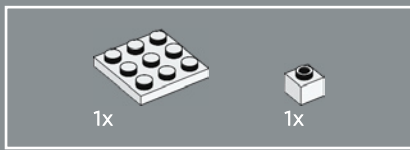

227

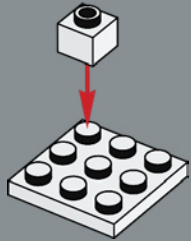

228

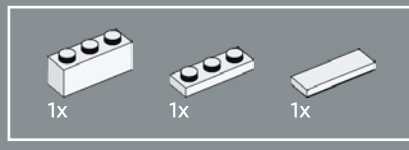
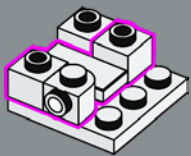

229

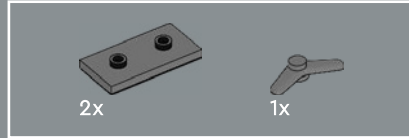
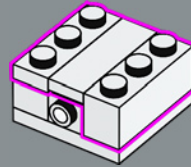

230

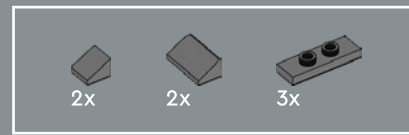
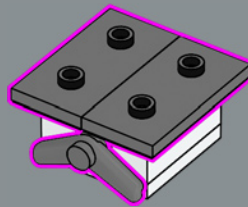

231

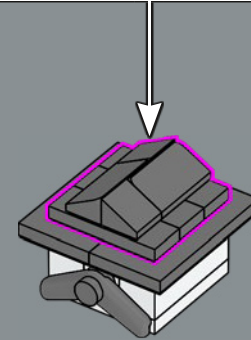
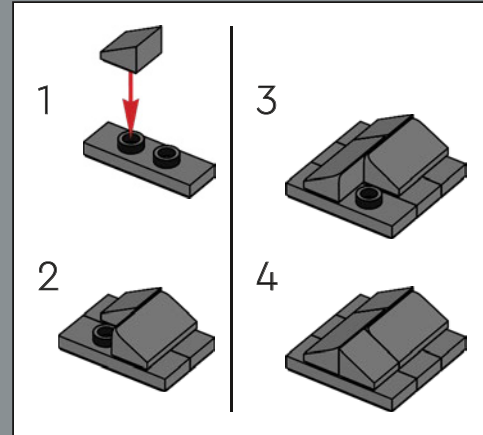

Dopo anni di esposizione, l'argilla bianca del tetto inizia a sporcarsi, cambiando lentamente l'aspetto e il colore del tetto.

232

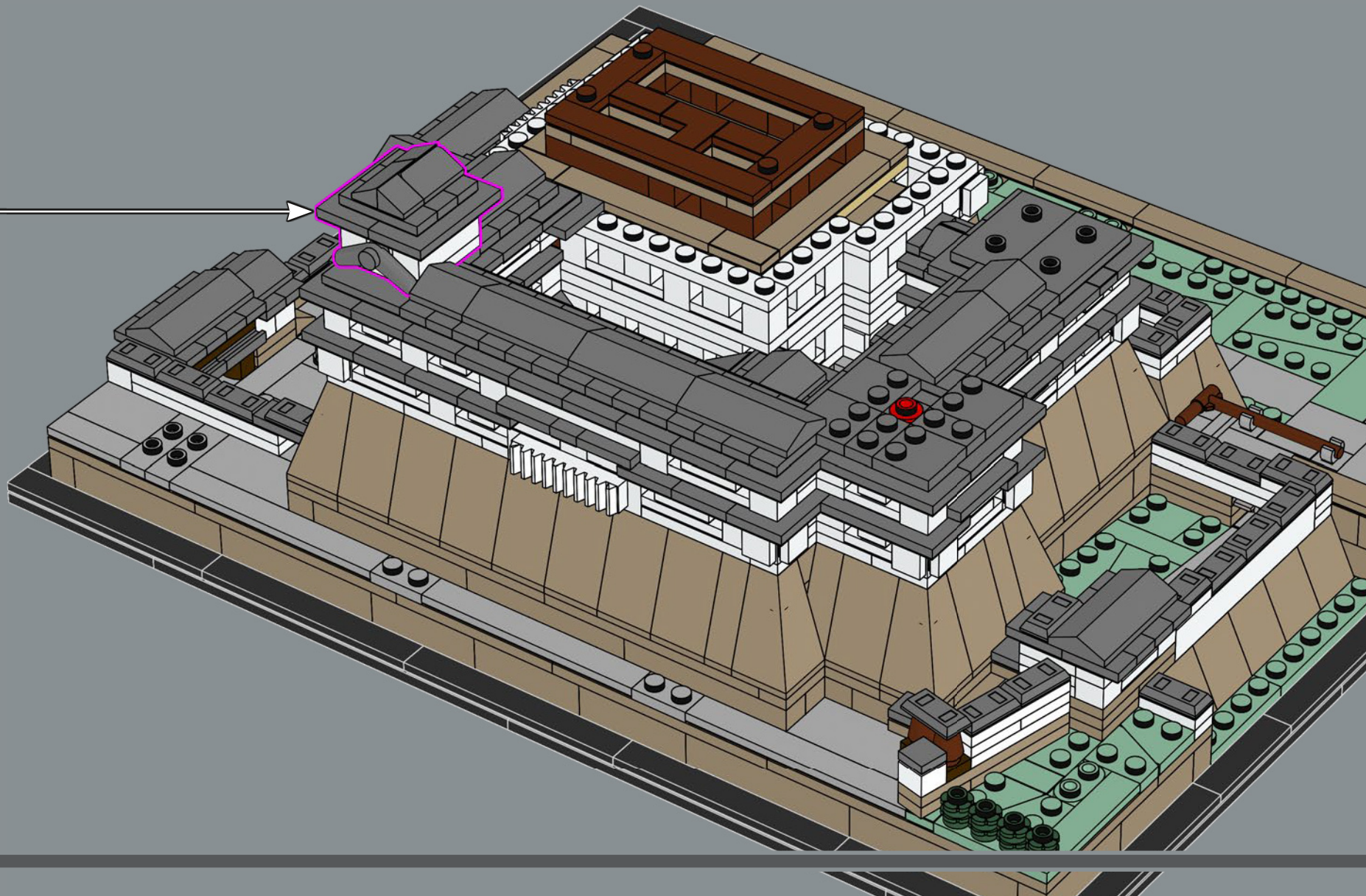

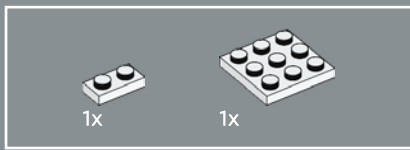

233

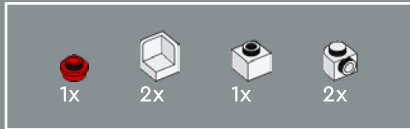
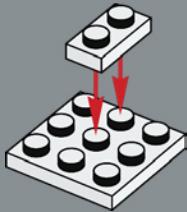

234

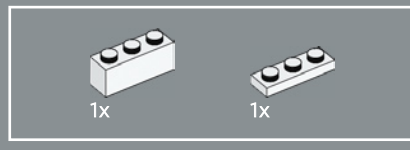
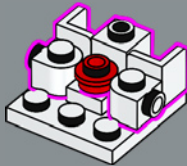

235

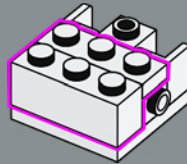

236

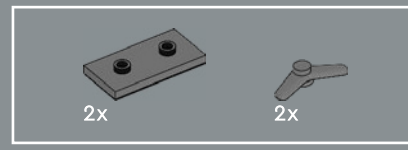
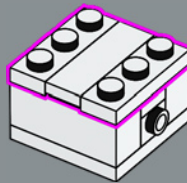

237

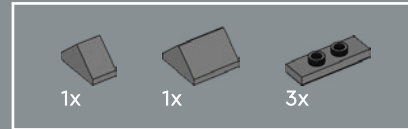
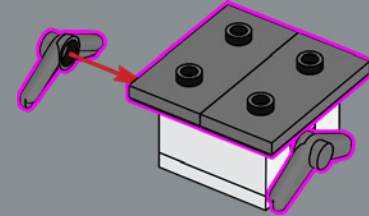

238

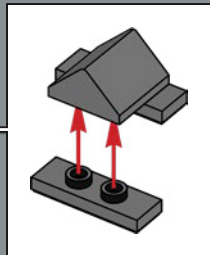
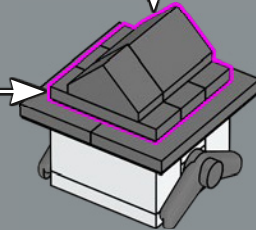
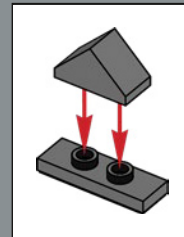

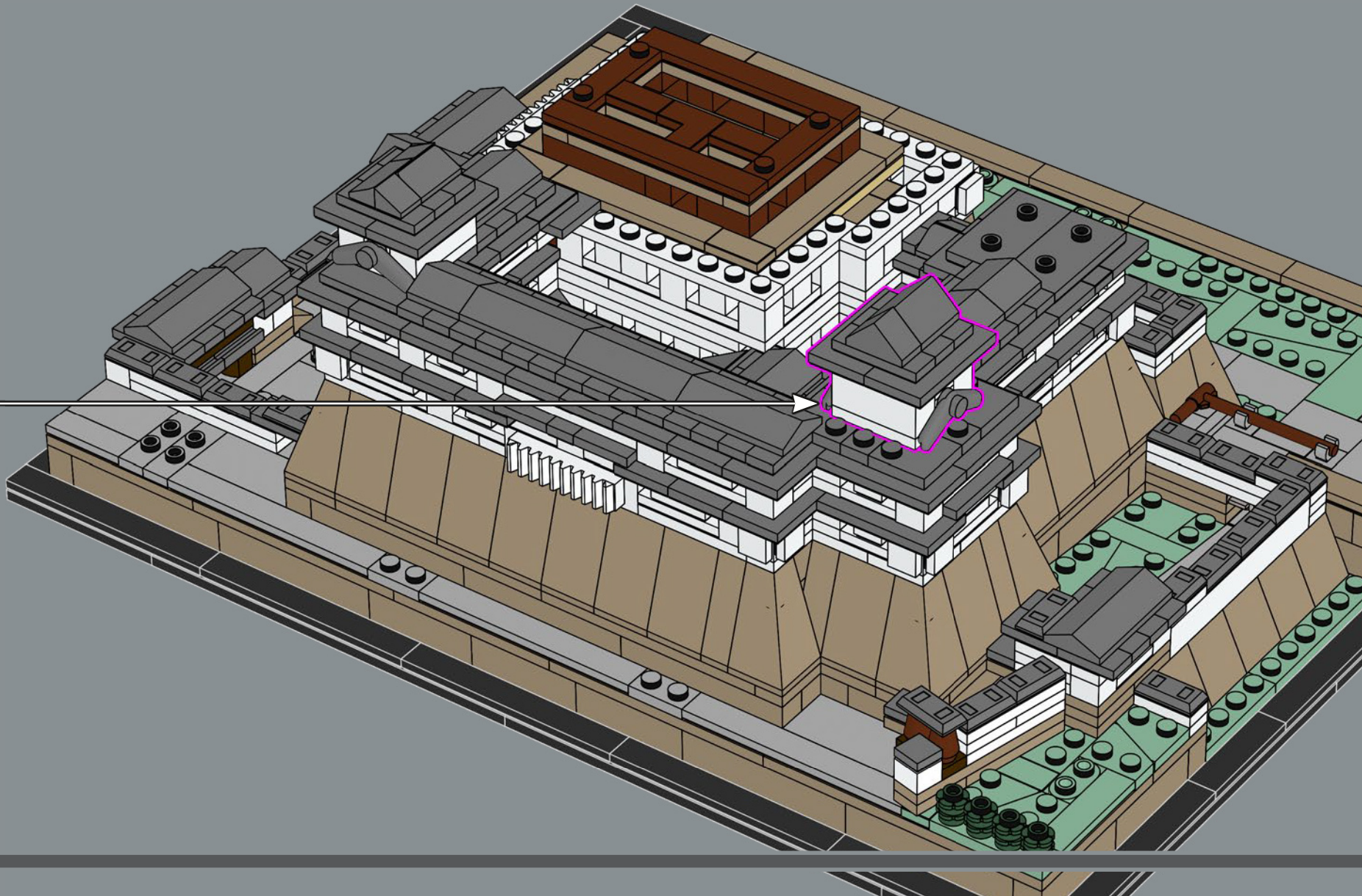



240

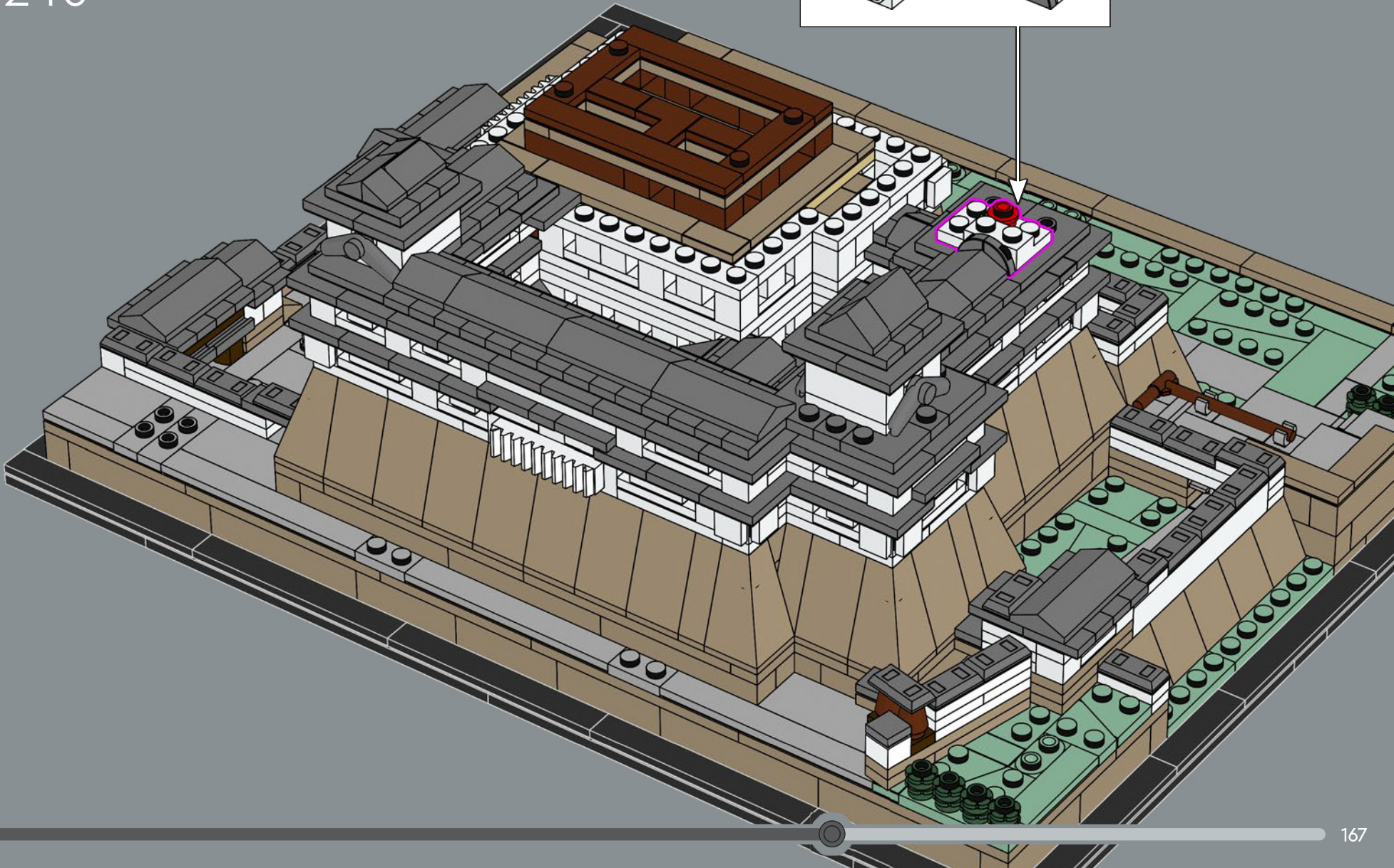
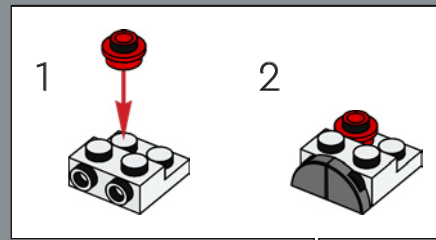

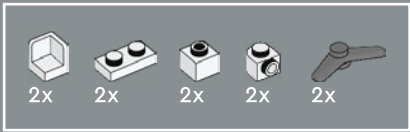

241

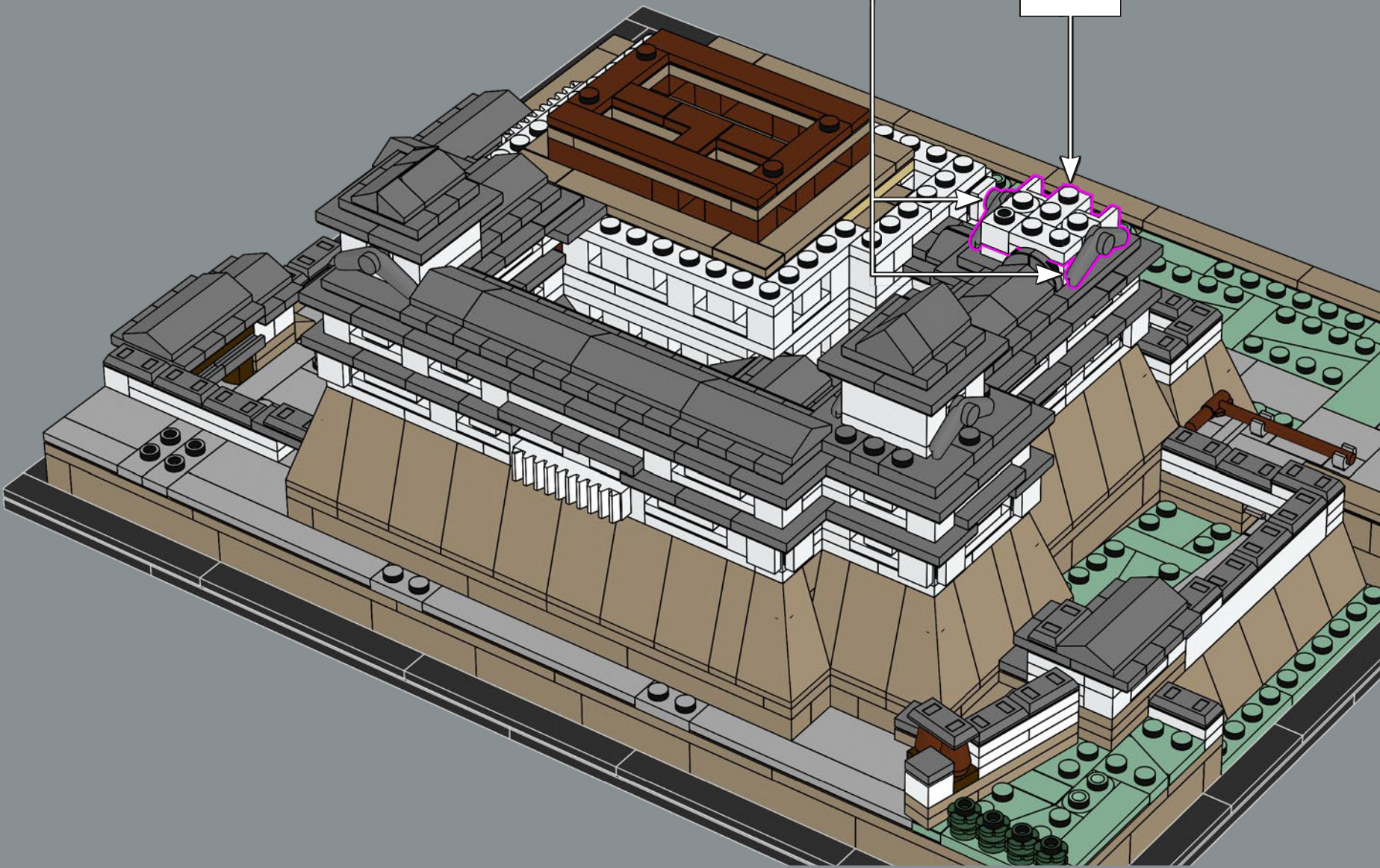
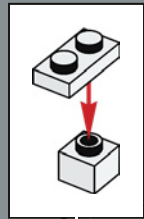
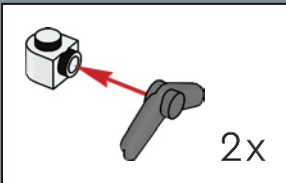

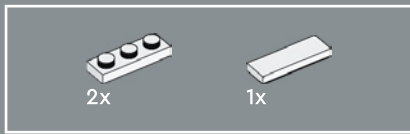

242

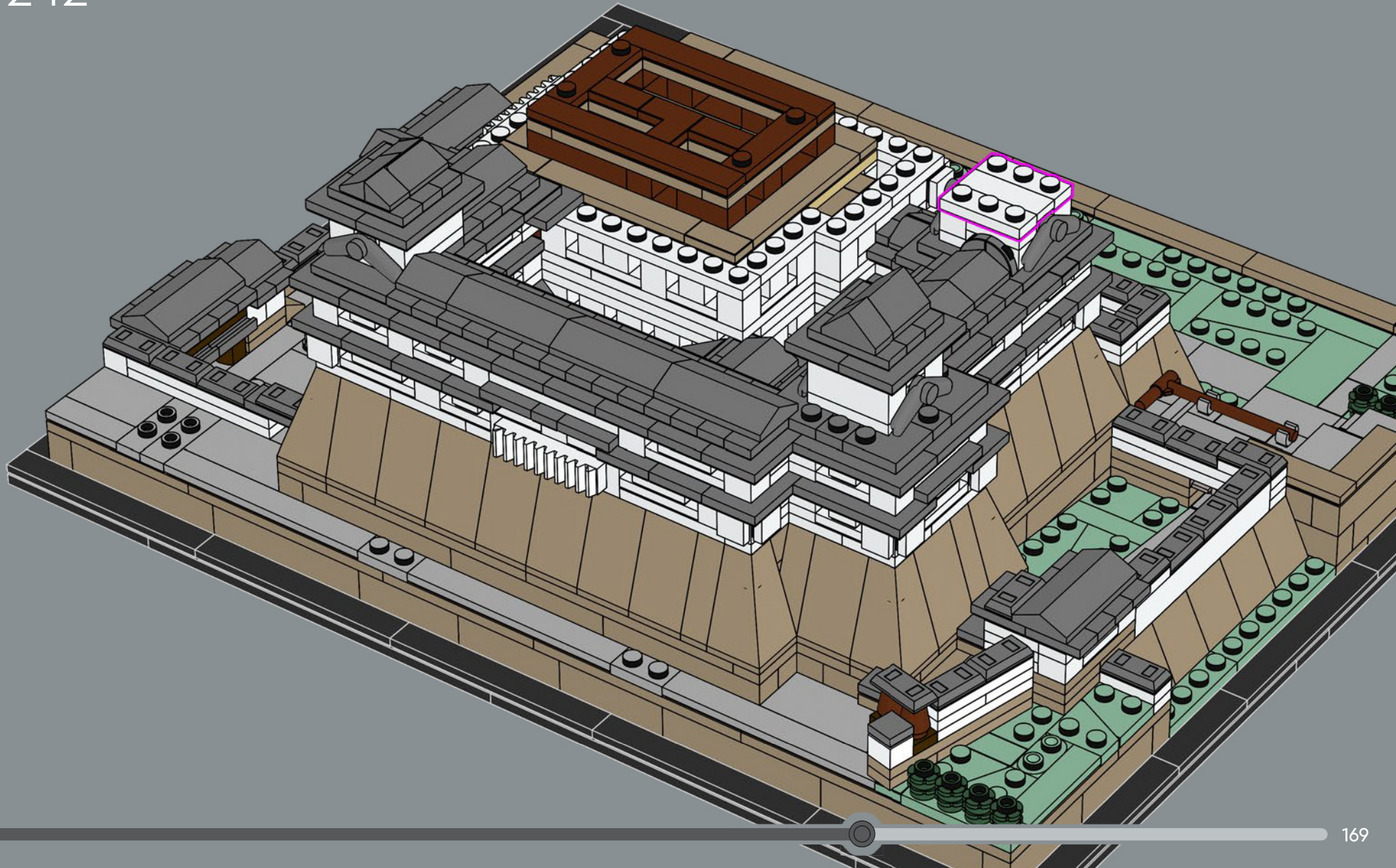

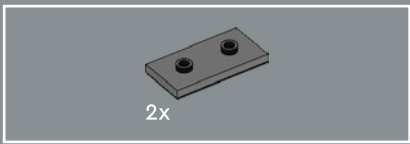

243

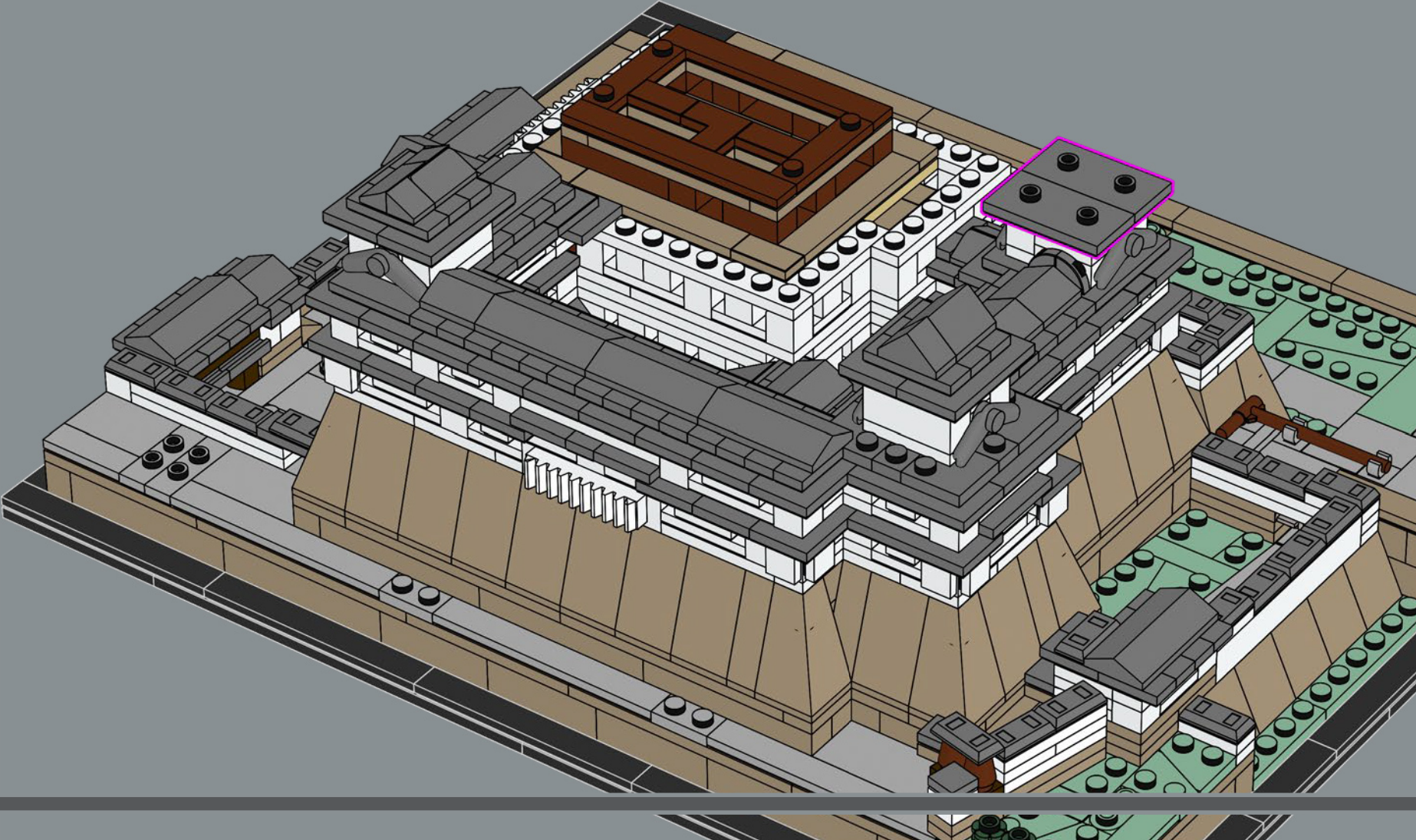

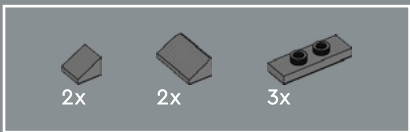

244

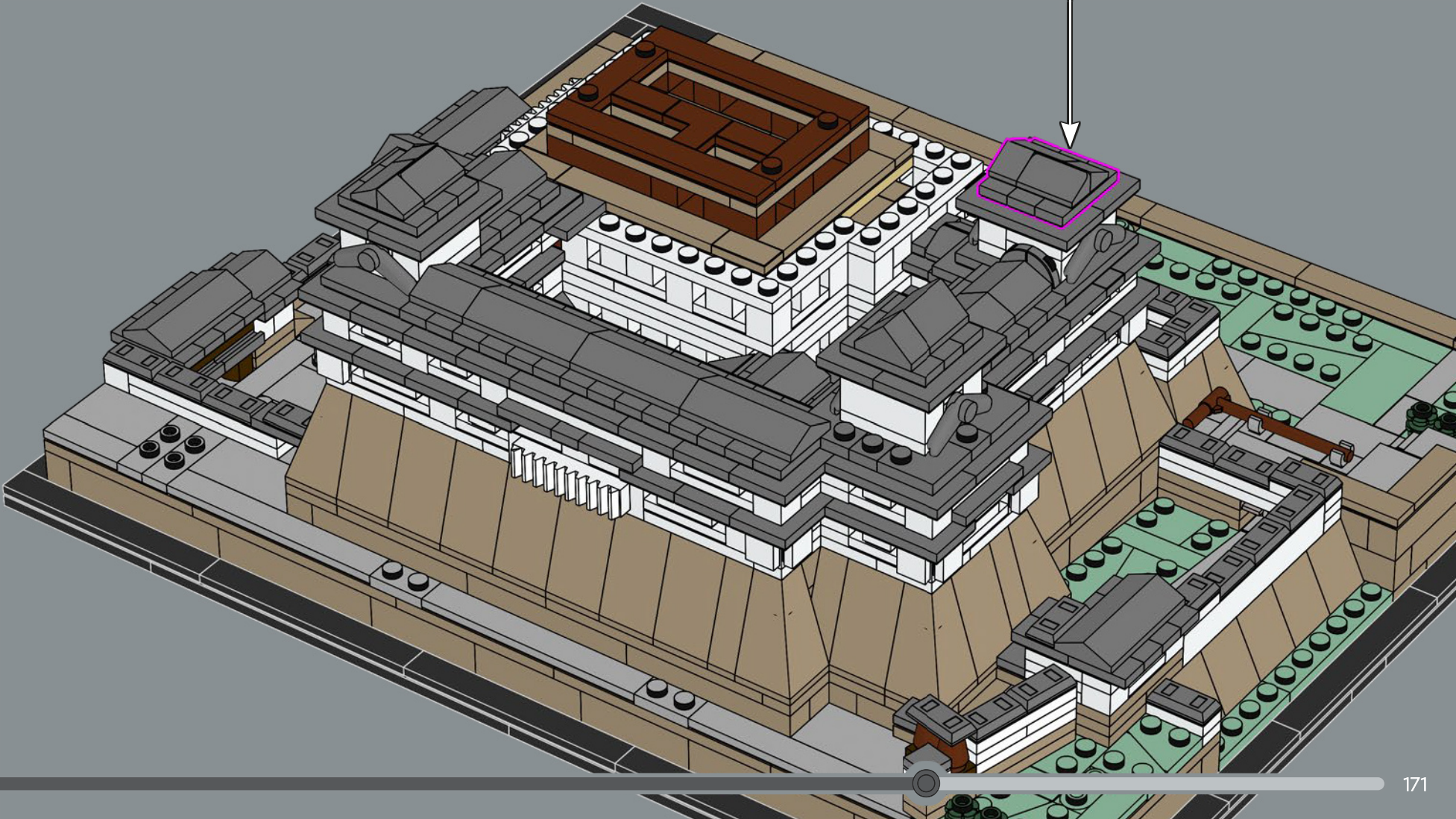
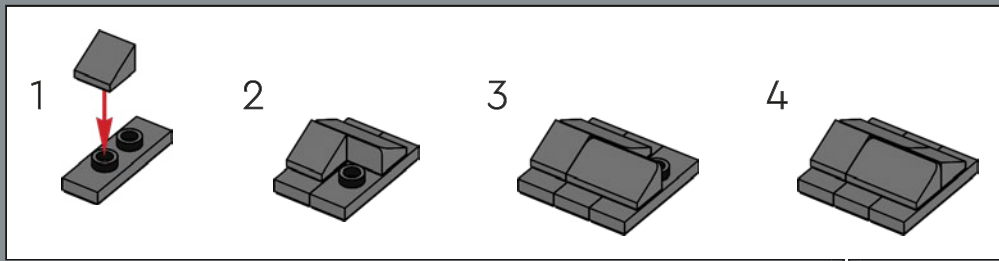

Il nuovo elemento angolare ad arco 2x2 è solo il secondo elemento NUOVO ad essere approvato per un set LEGO® Architecture. Il primo era un elemento simile, in formato 3x3, della Robie House 21010 (2011).

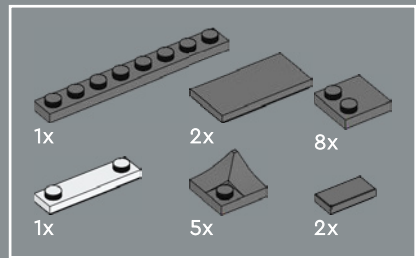

245

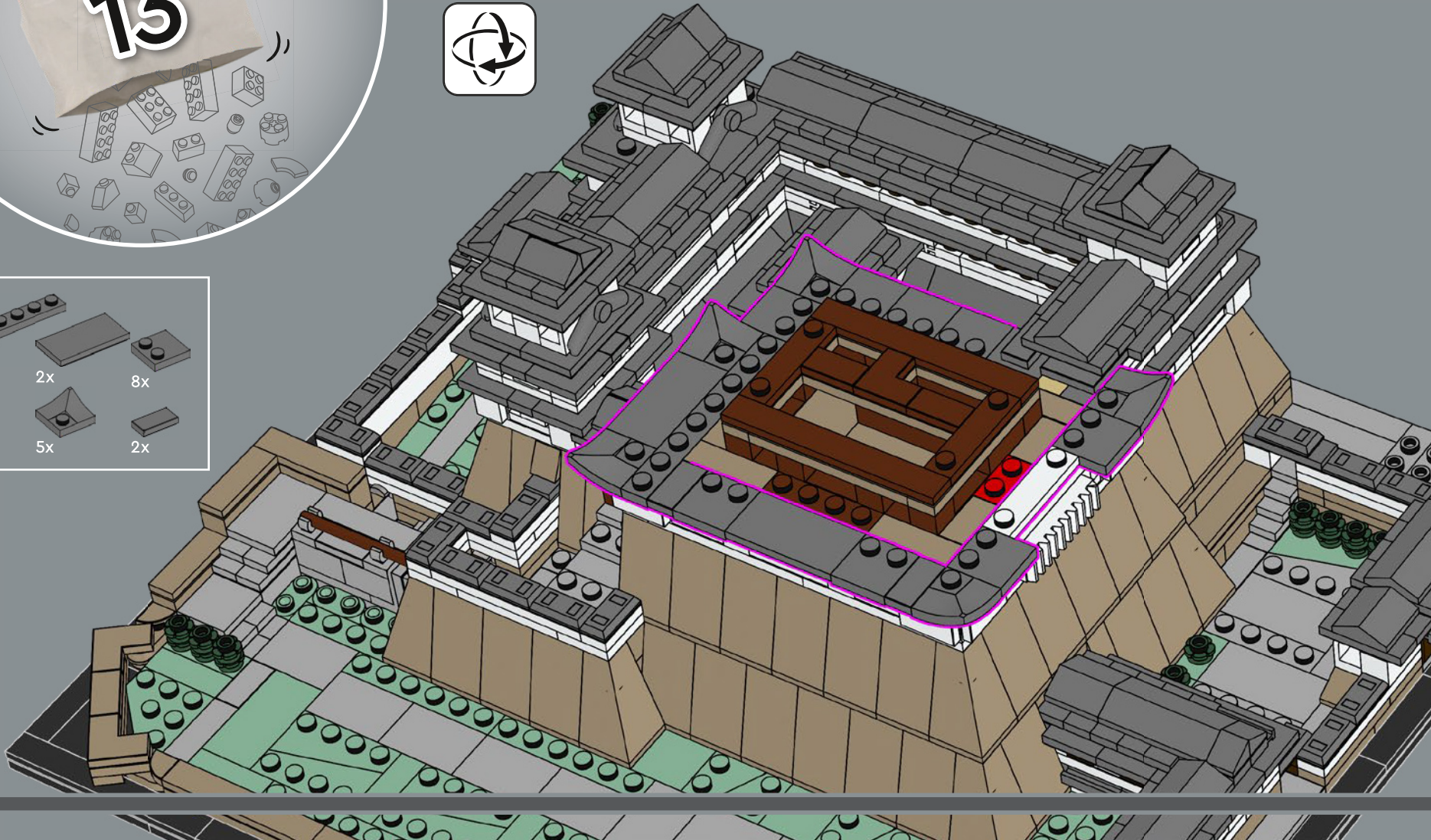

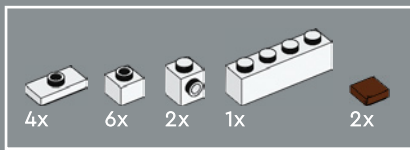

246

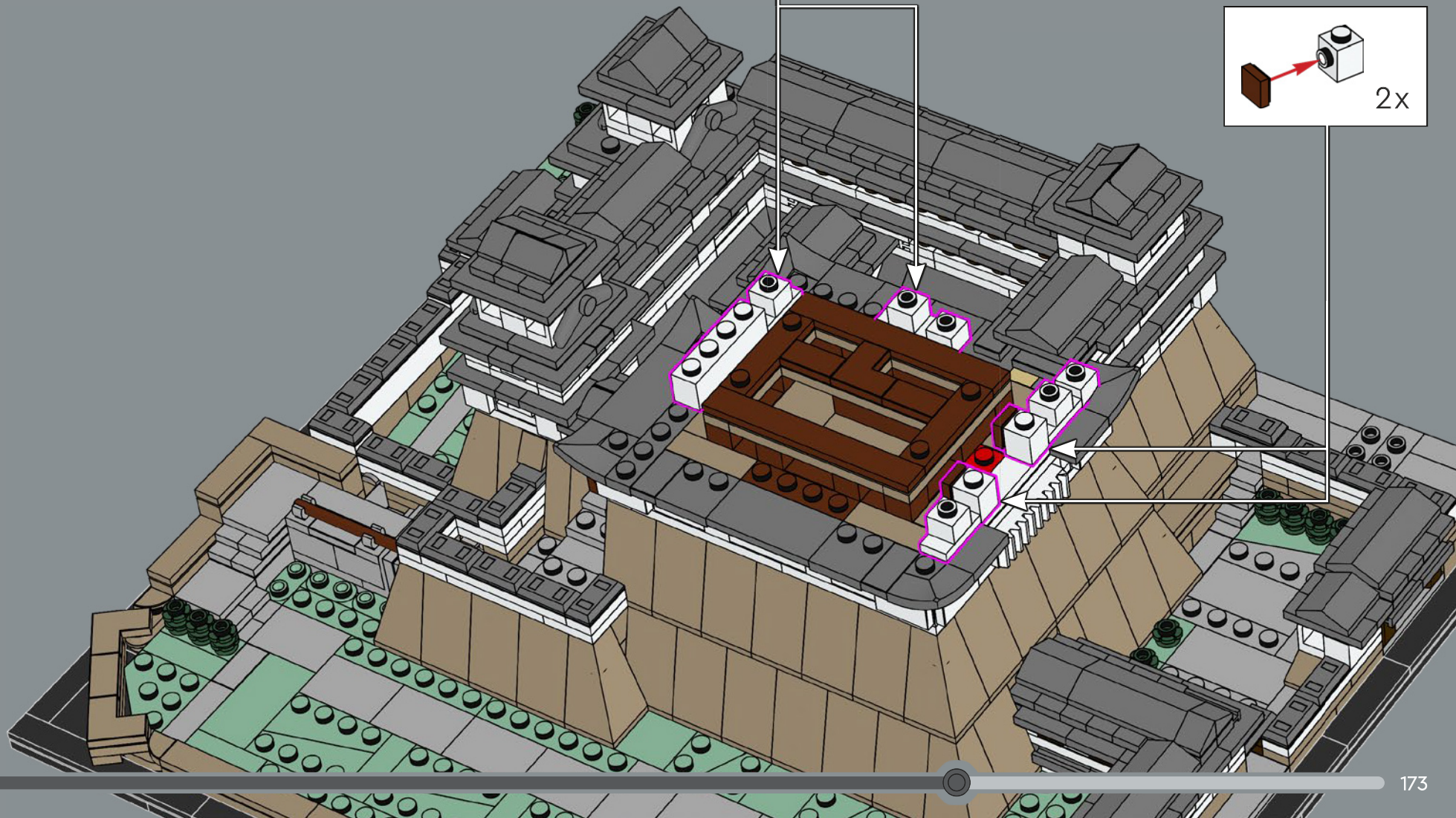
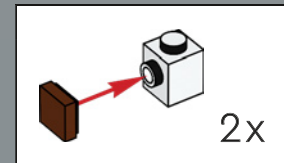
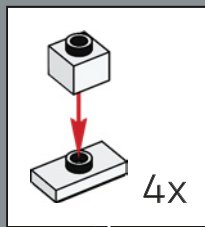

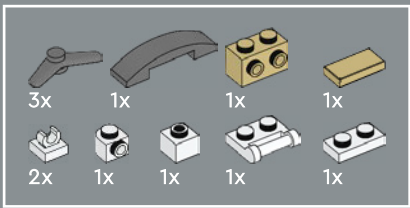

247

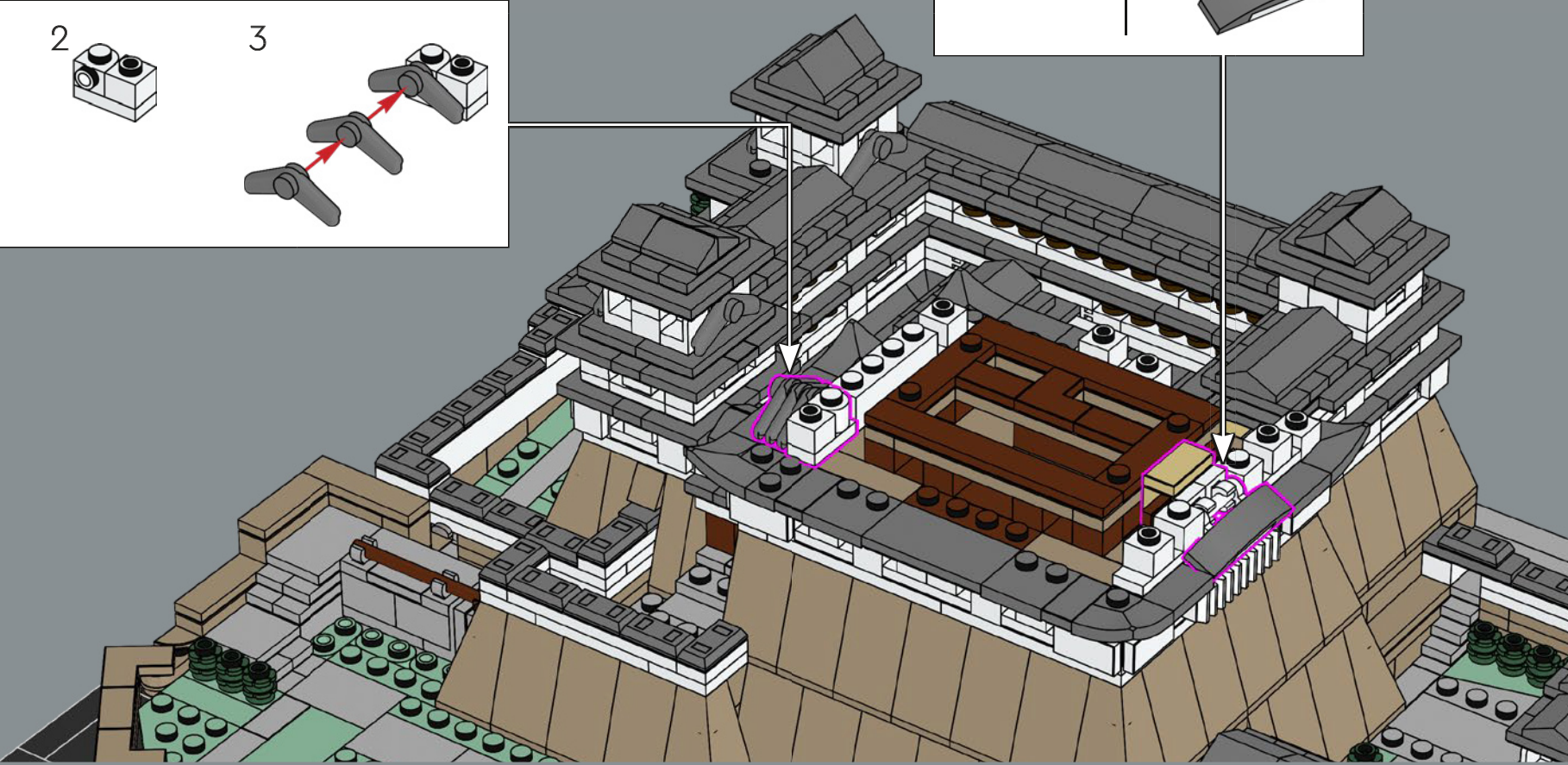
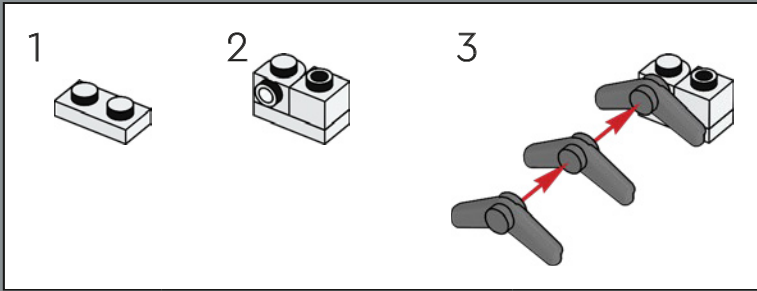
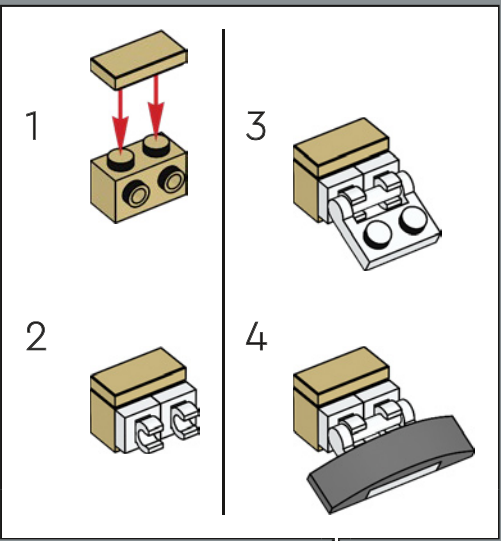

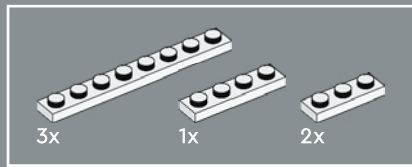

248

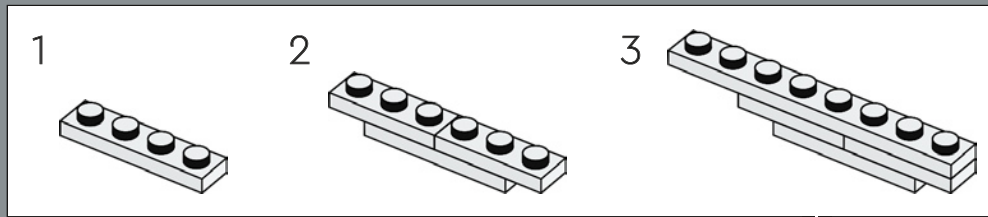

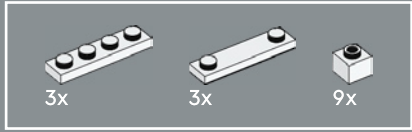
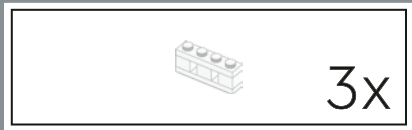

249

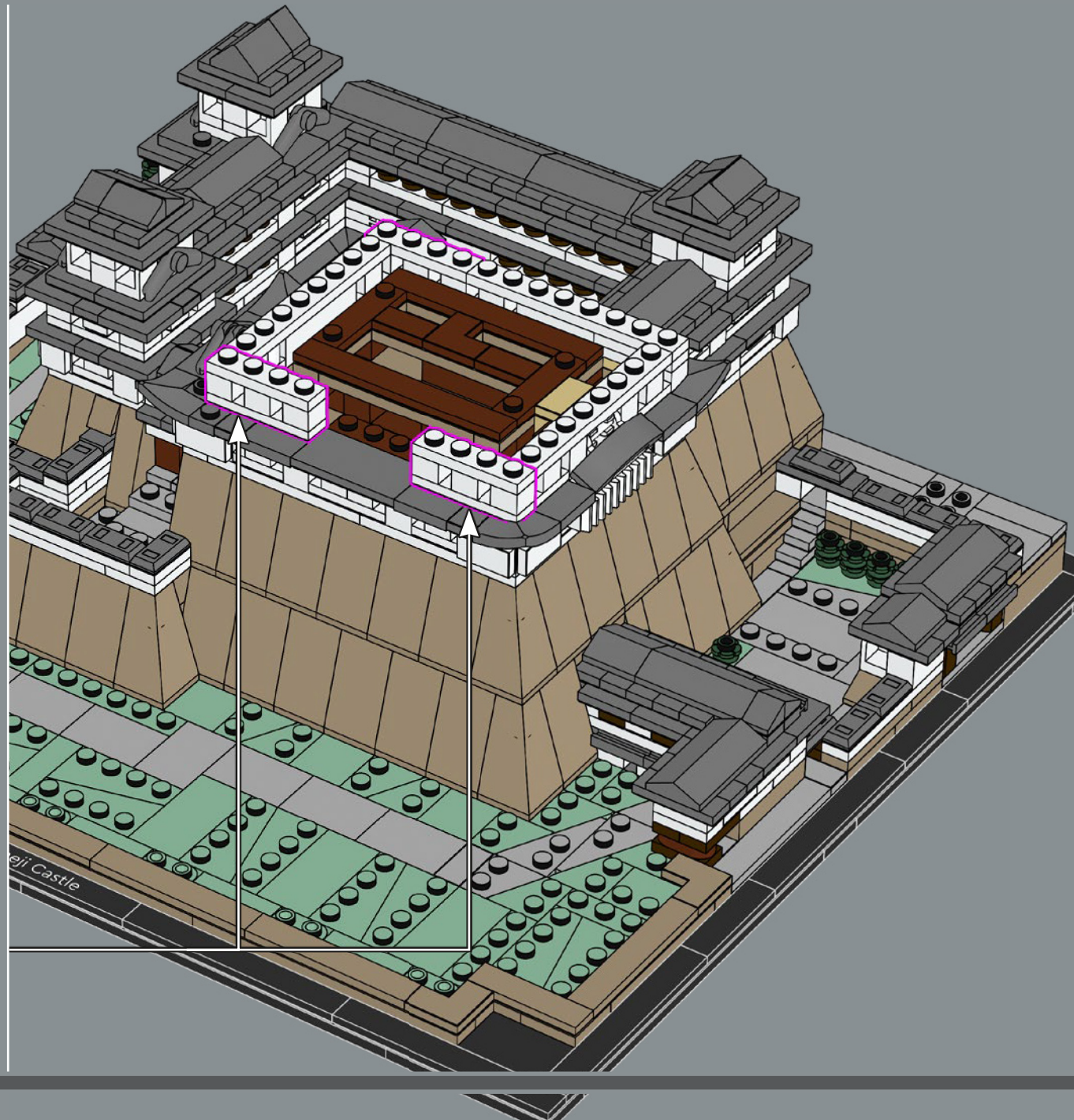
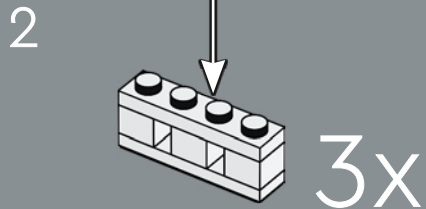
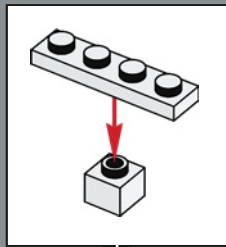
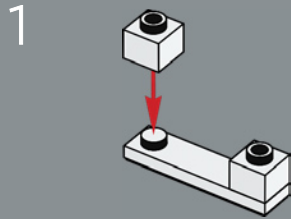

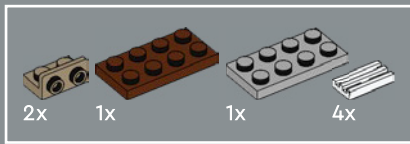

250

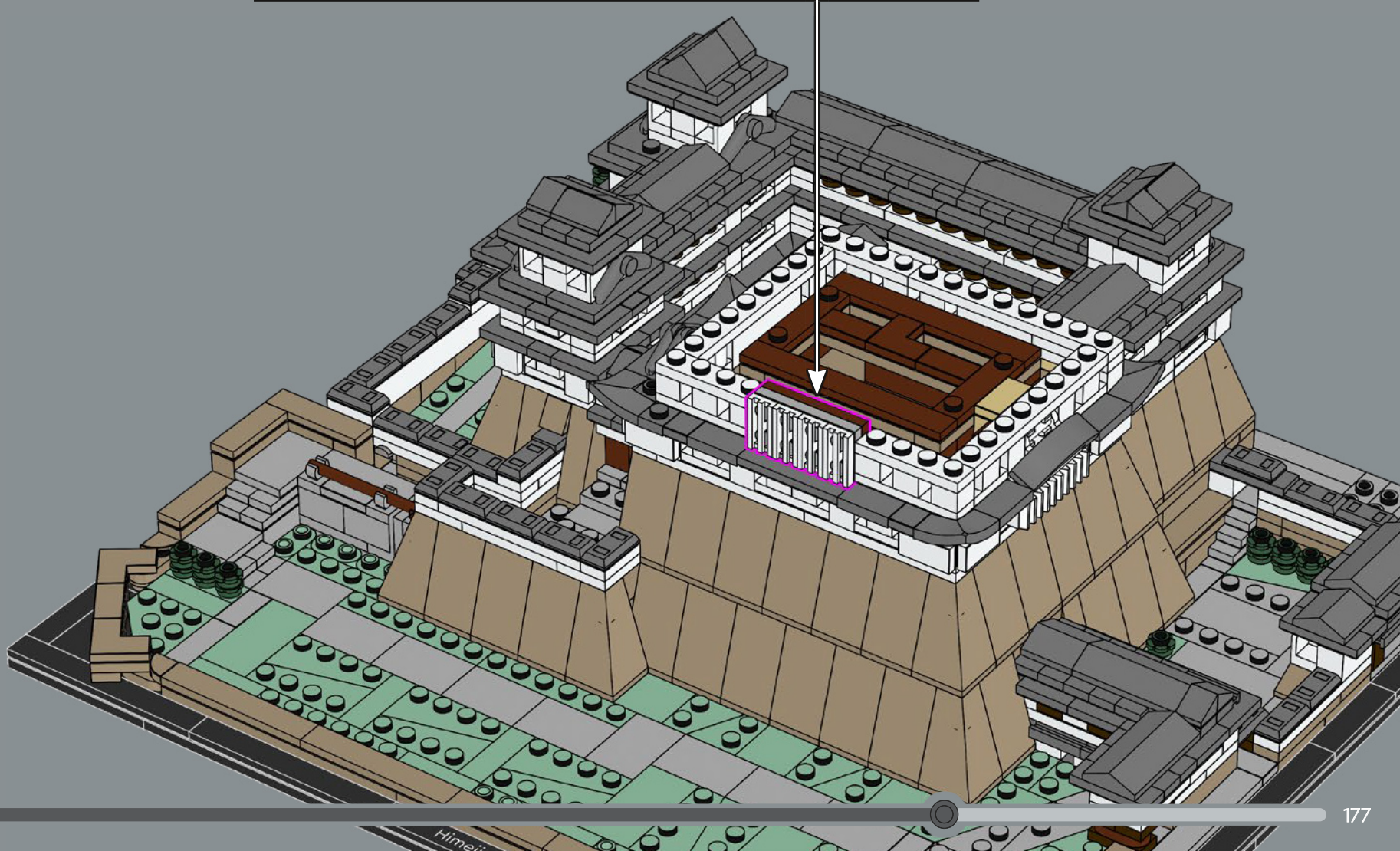
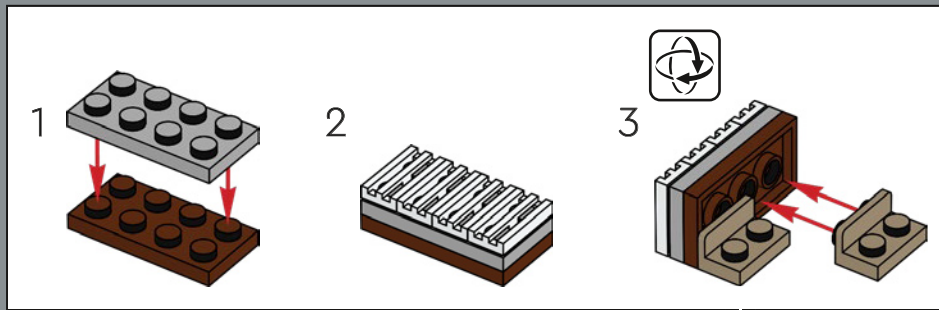

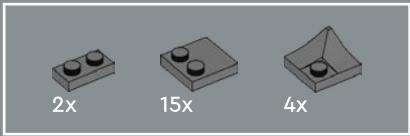

251



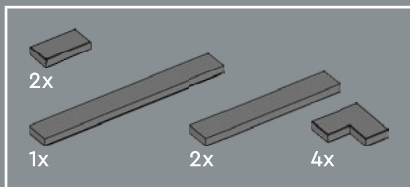

252

La parte superiore della struttura può essere rimossa per rivelare alcuni degli interni, tra cui l'area del consiglio, per lo più vuota, per mostrare come si presentava durante la ristrutturazione del 2009-2015.

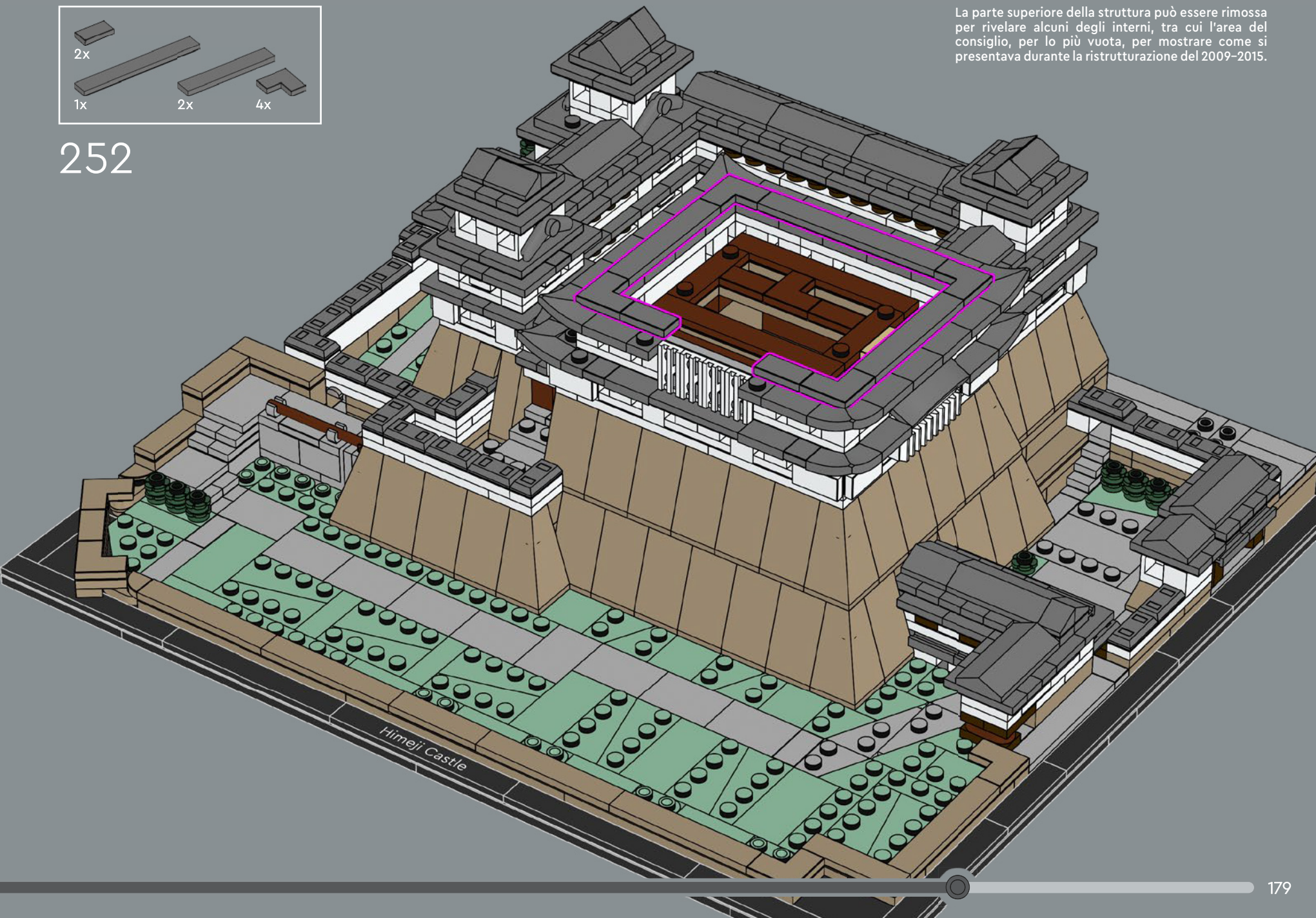

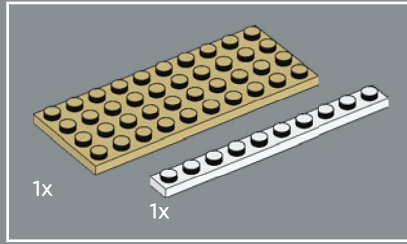
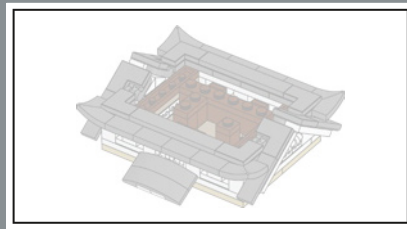

253

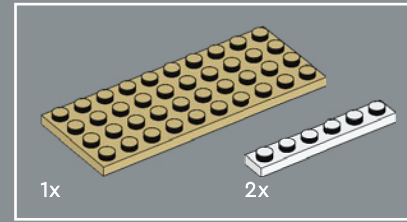
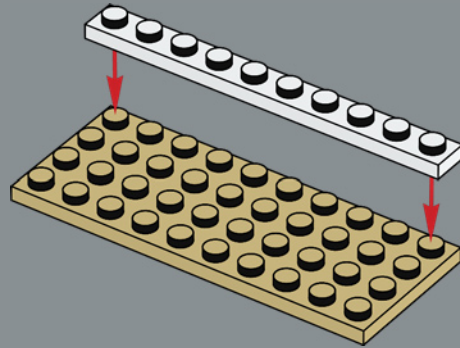

254

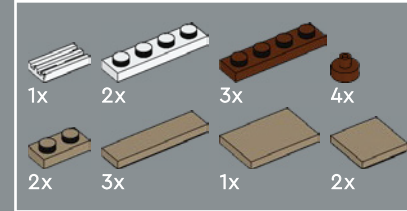
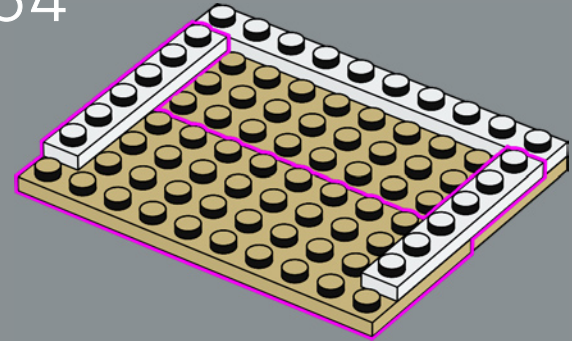

255

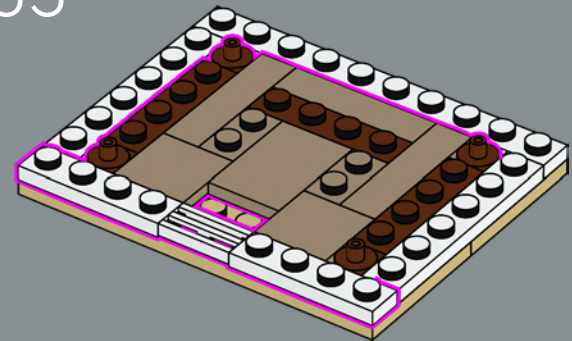

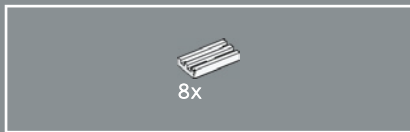

256

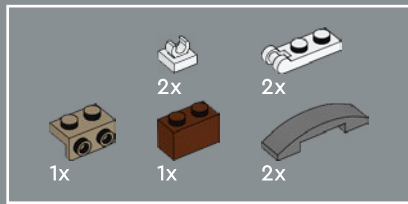
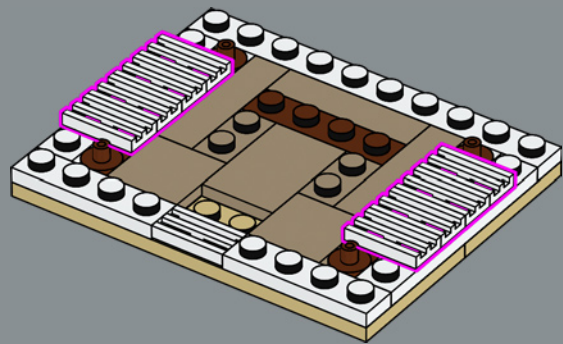

257

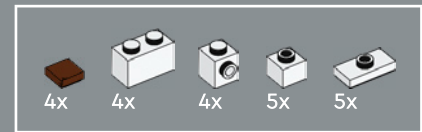
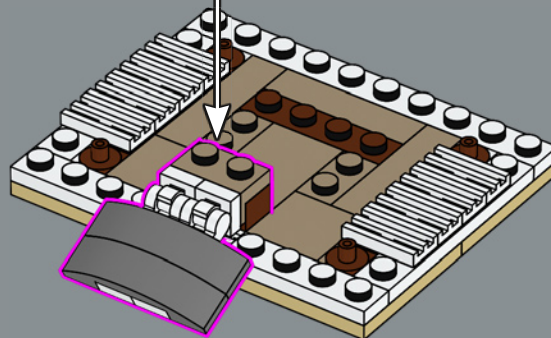
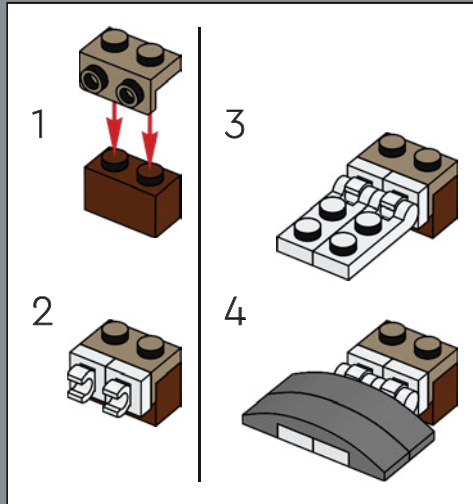

258

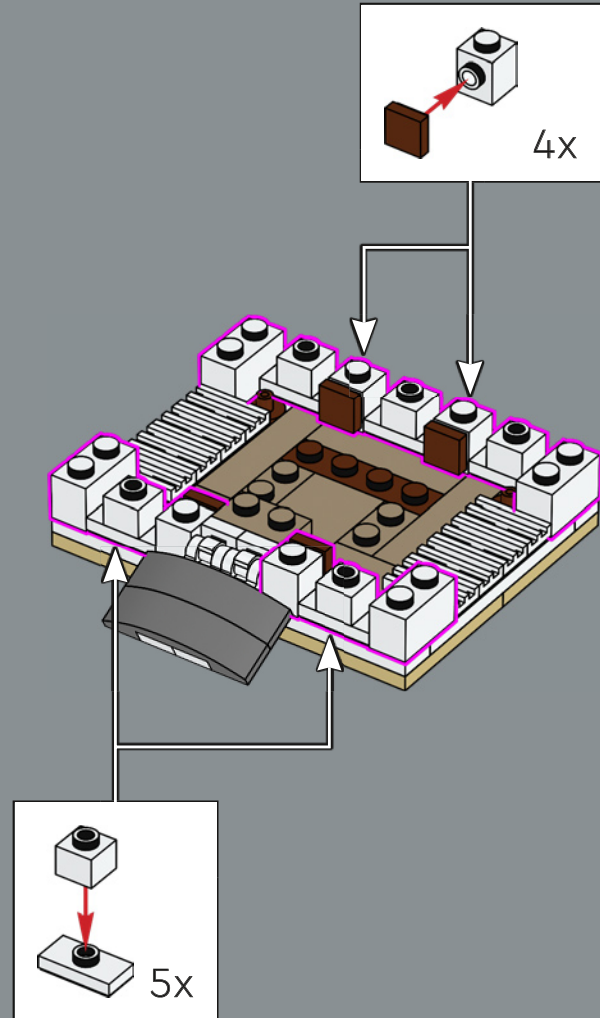

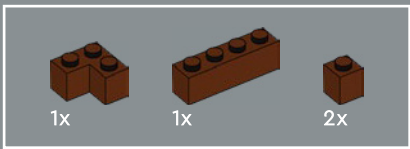

259

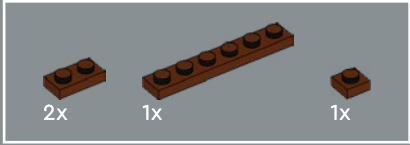
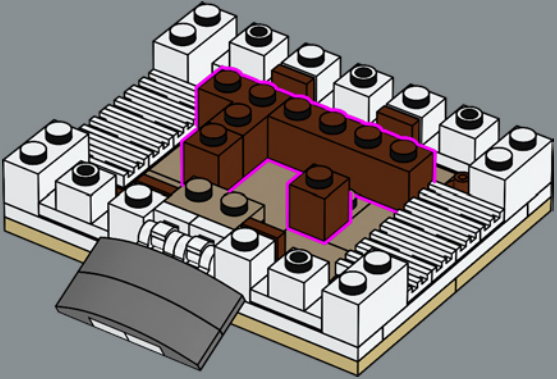

260

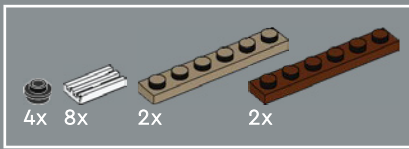
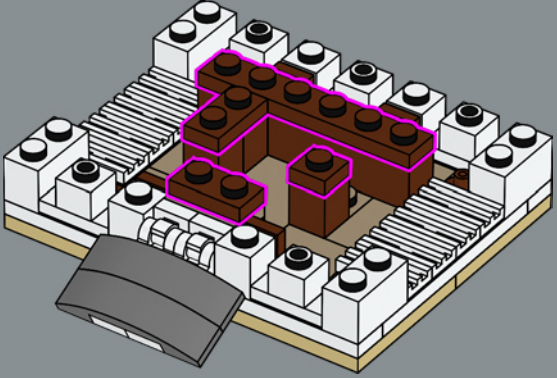

261

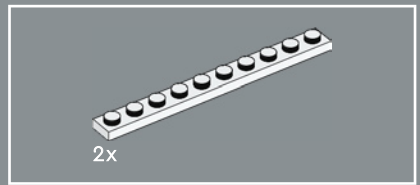
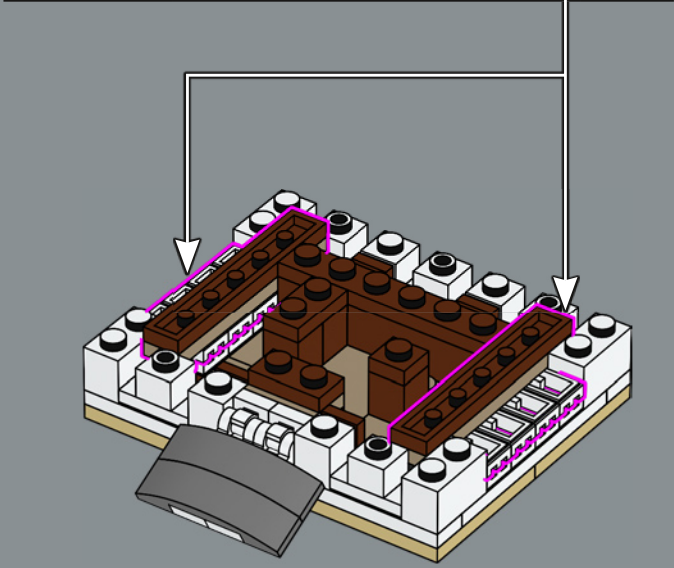
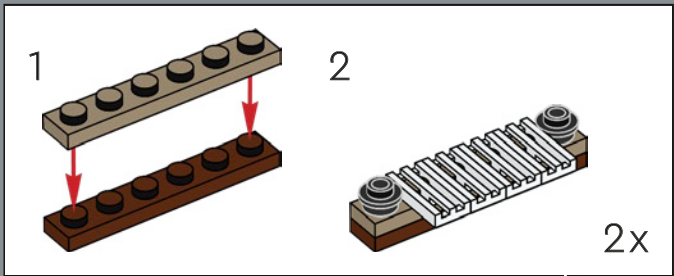

262

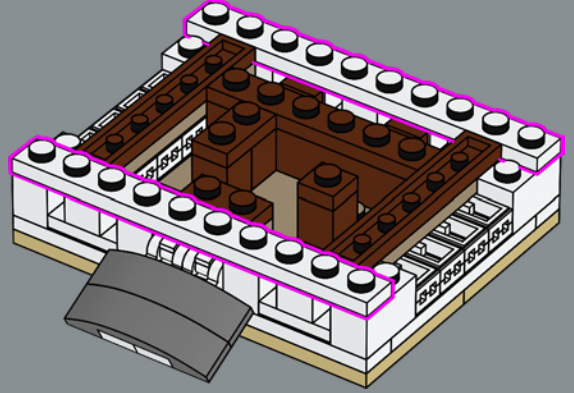

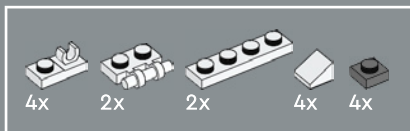

263

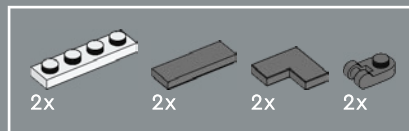
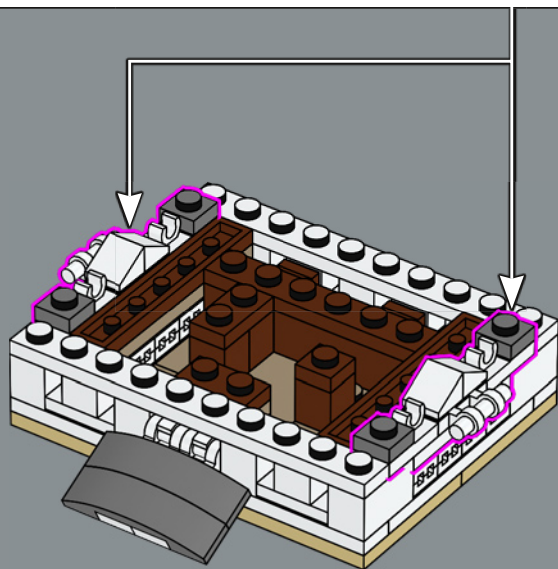
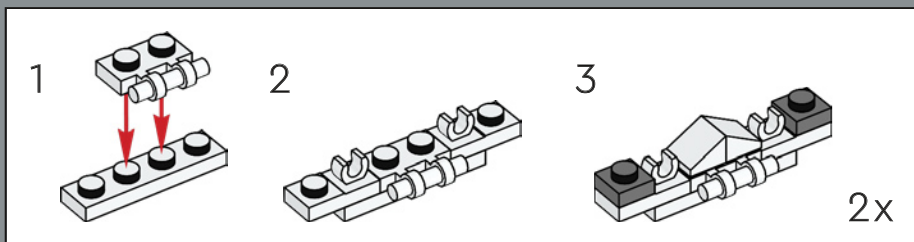

264

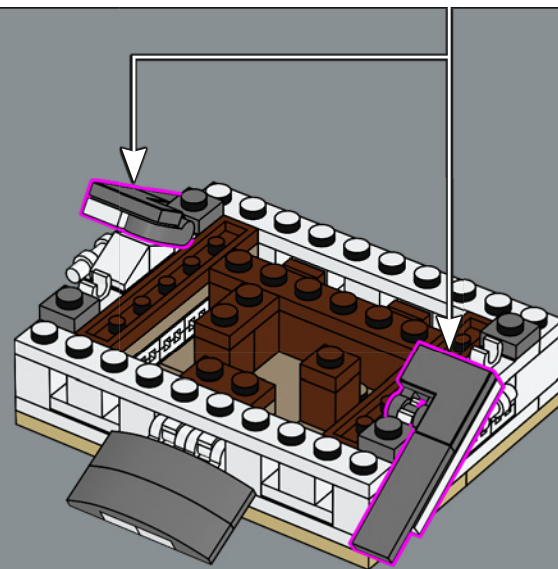
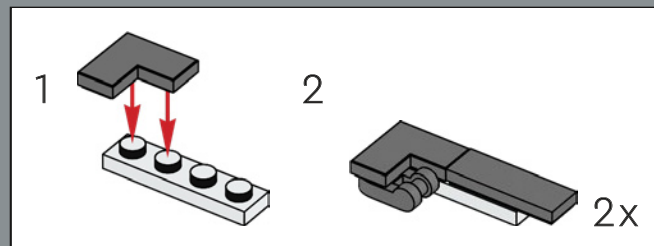

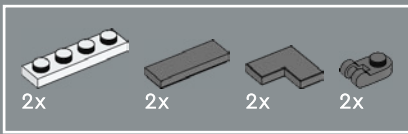

Ogni piano del maschio principale del castello ha una disposizione unica che si ispira alle piante del castello originale.

265

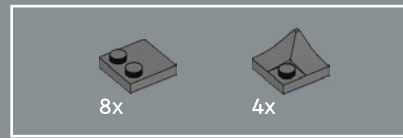
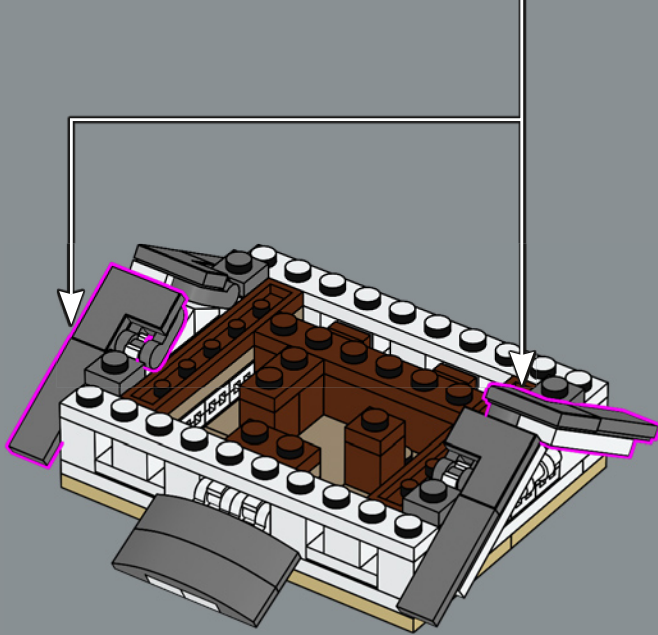
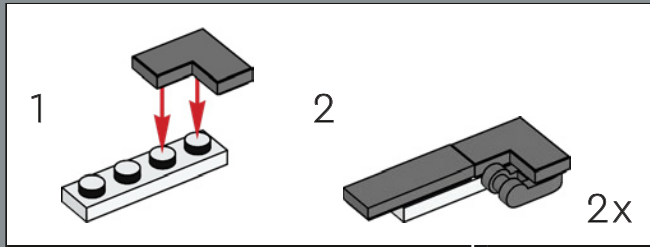

266

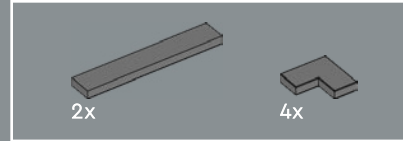
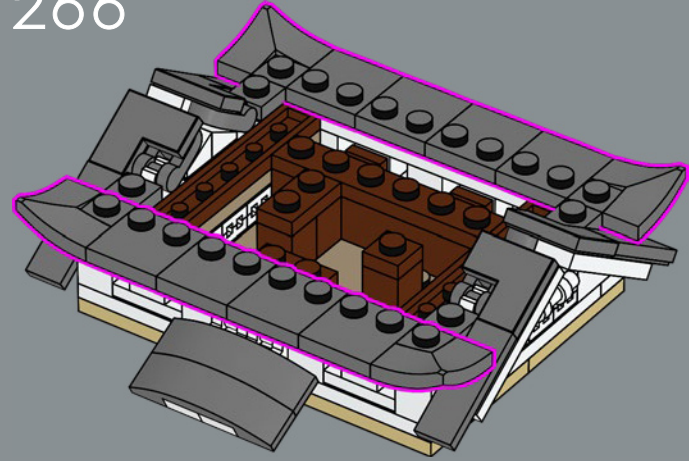

267

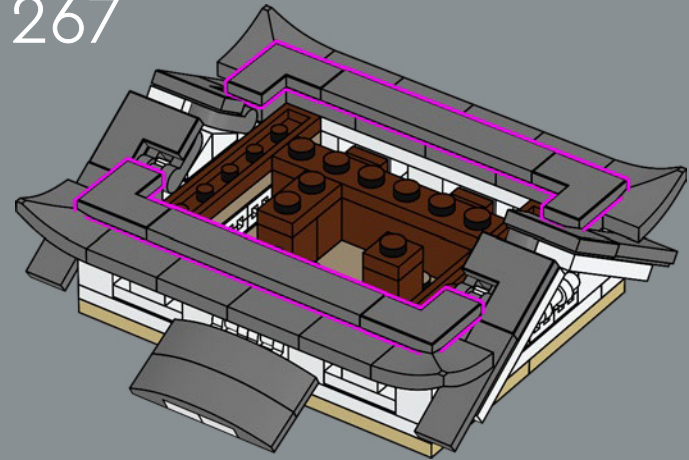

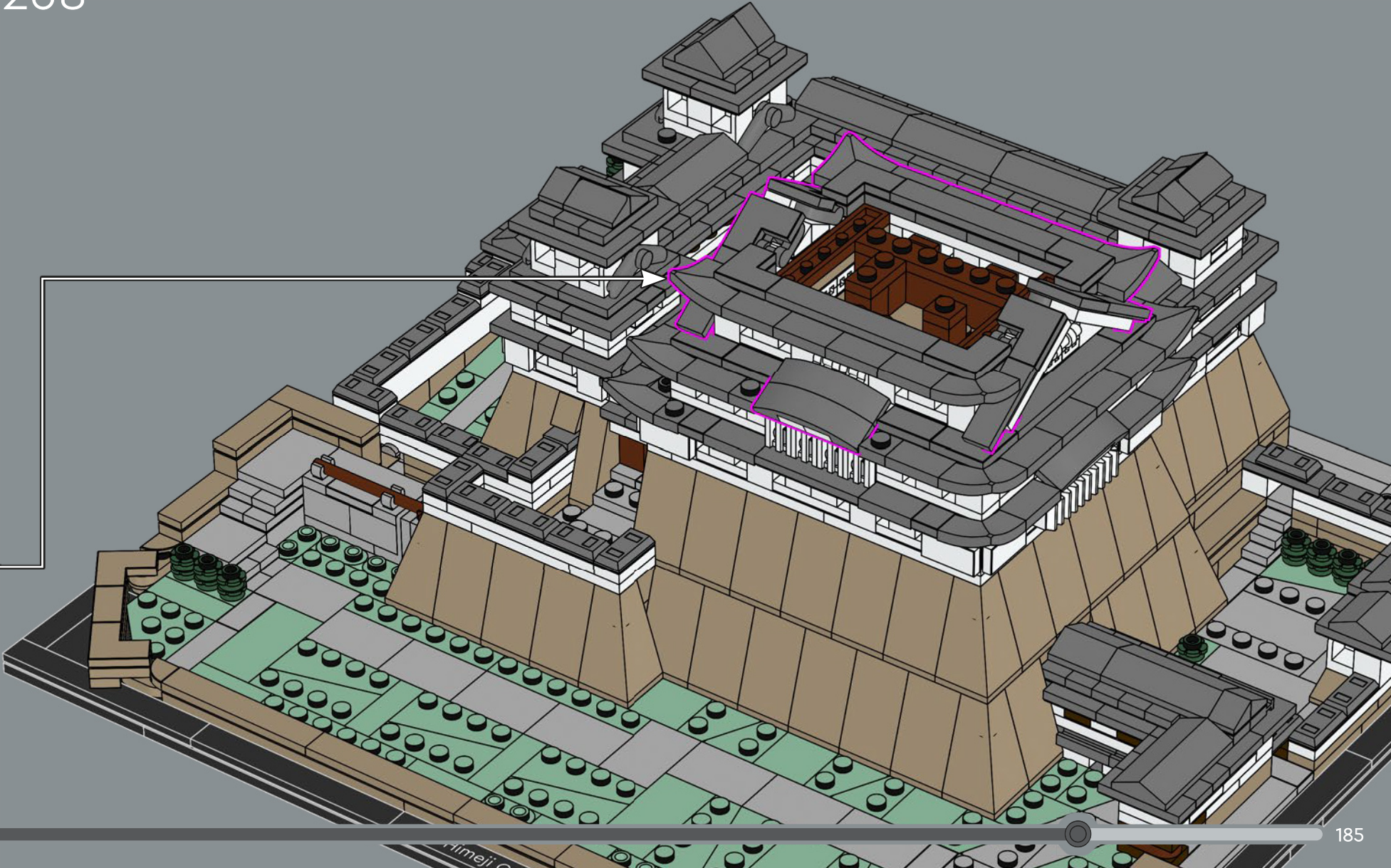

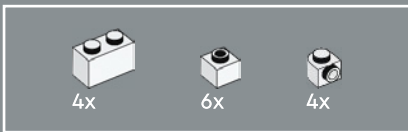

272

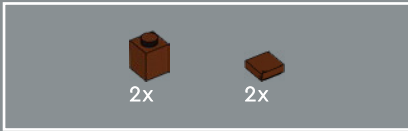
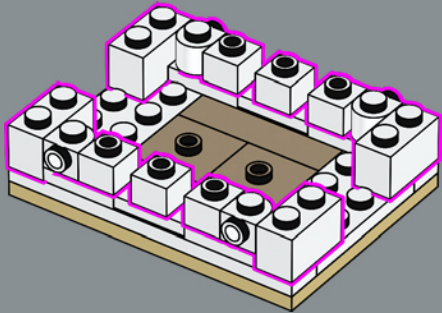

273

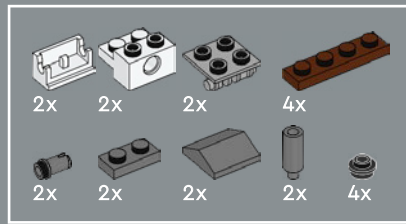
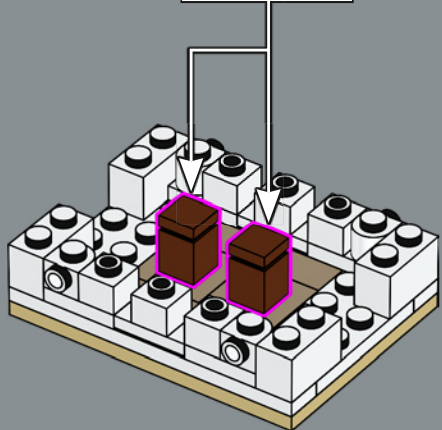
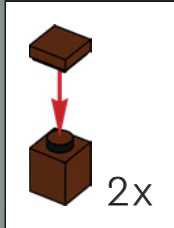

274

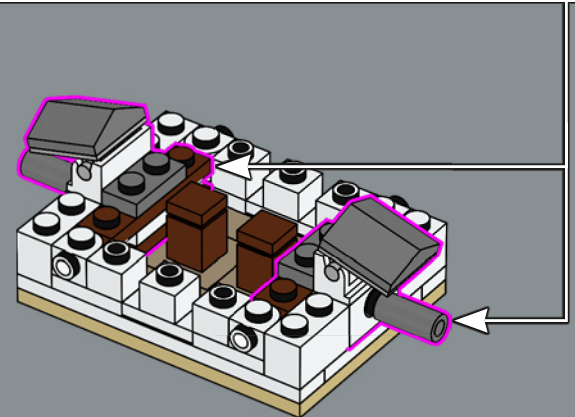
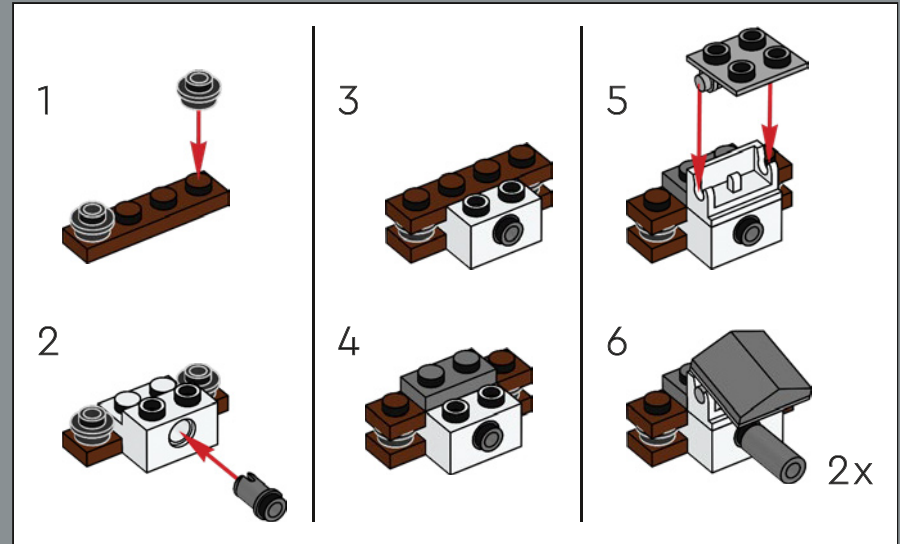

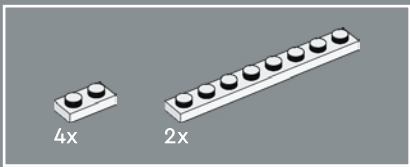

275

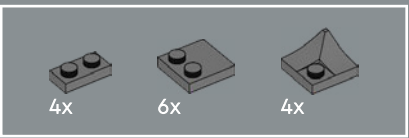
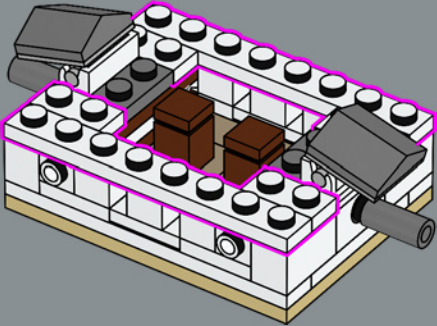

277

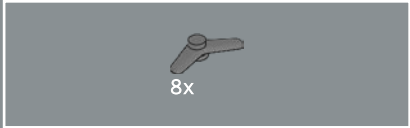
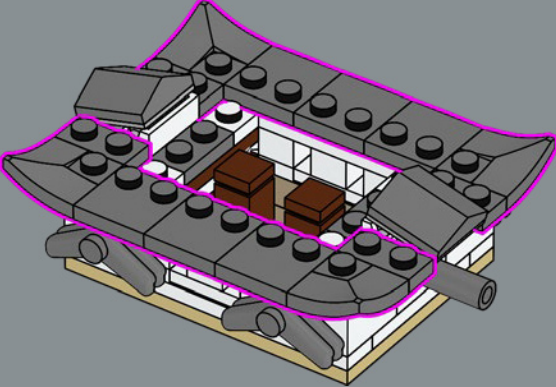

276

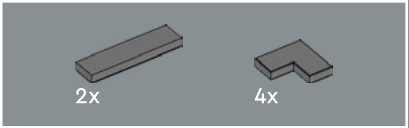
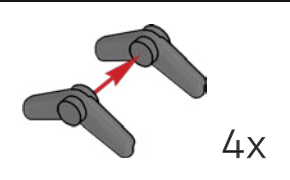
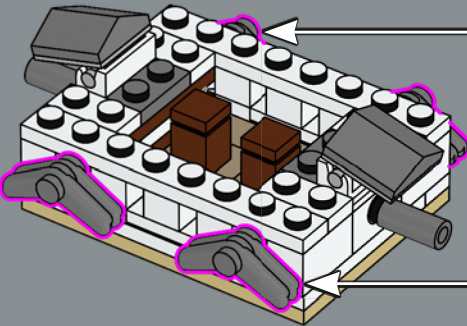

278

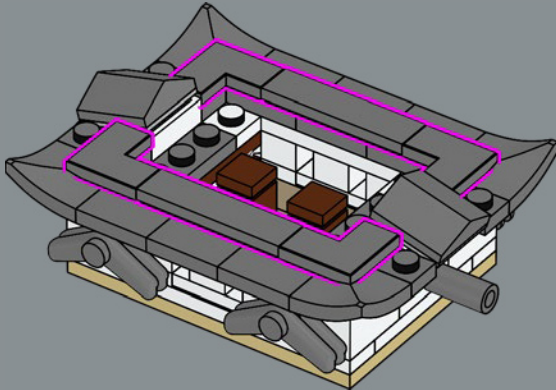

279

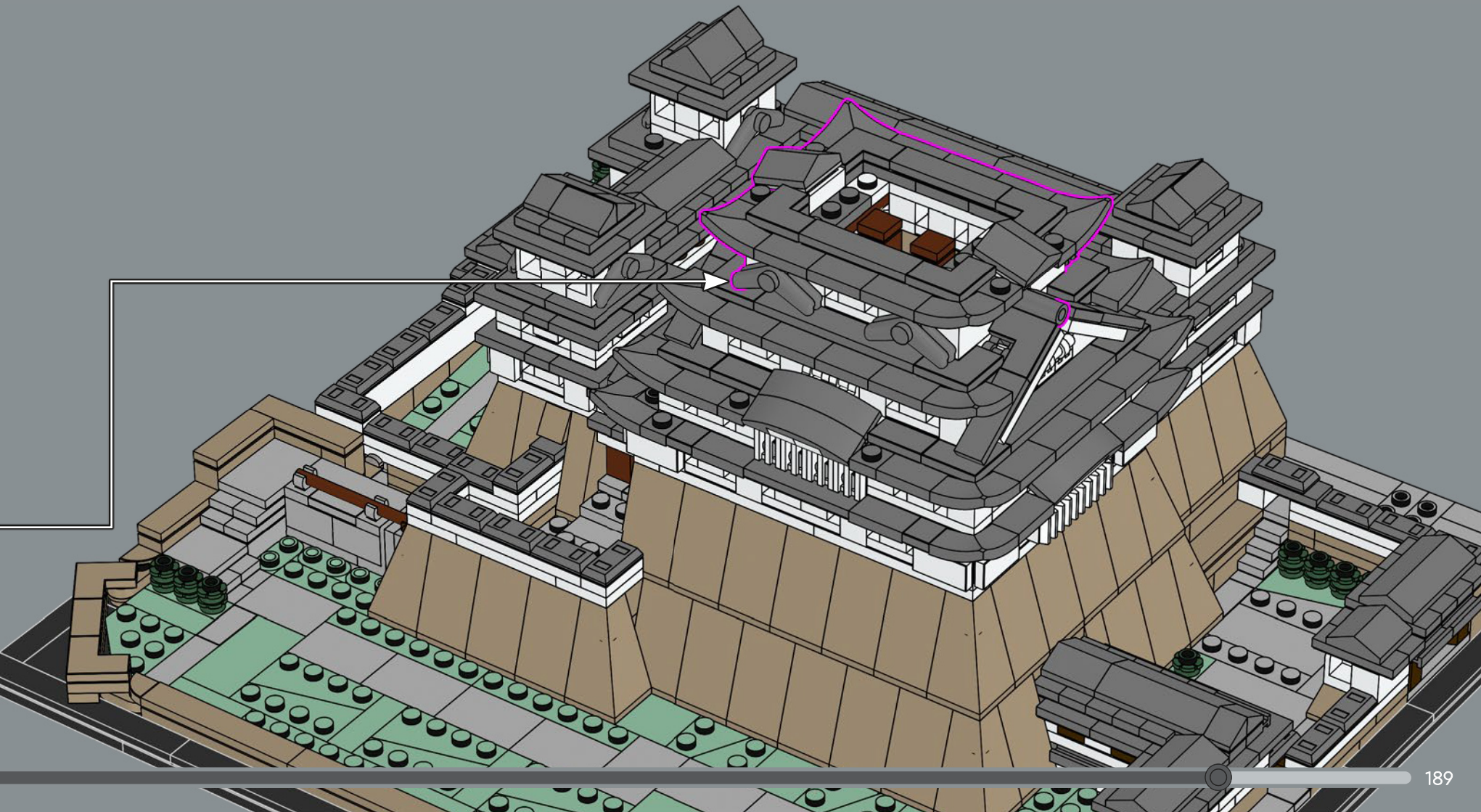

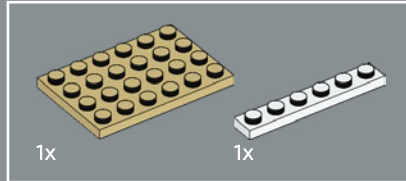
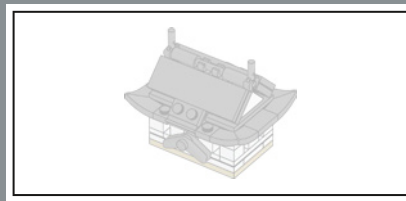

280

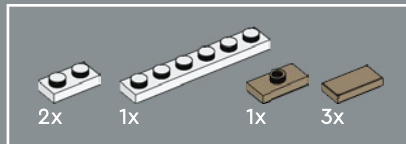
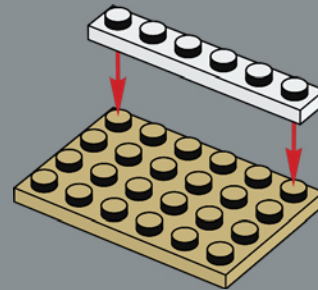

281

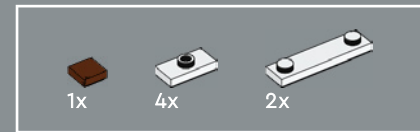
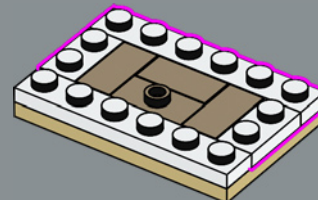

282

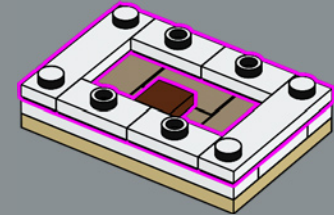

283

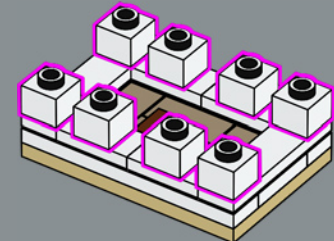

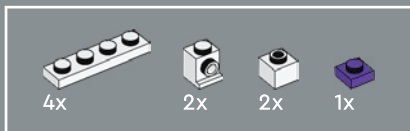

La tessera viola 1x1 nella camera dell'ultimo piano del maschio principale è un richiamo al reliquiario sacro in legno coperto da un drappo viola all'interno di questa camera del castello.

284

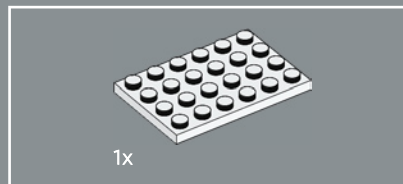
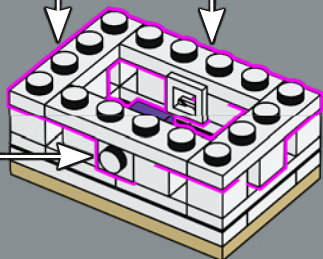
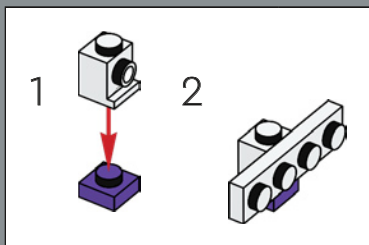
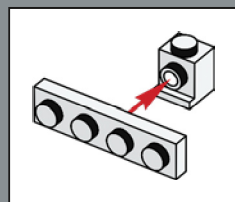
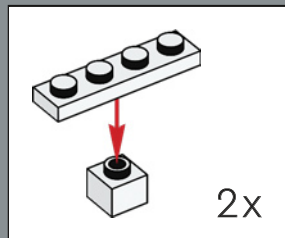

285

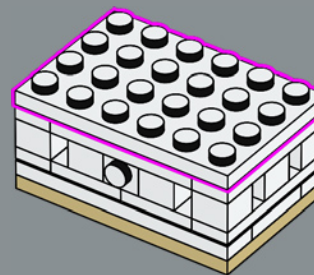

286

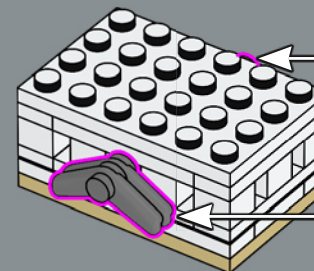
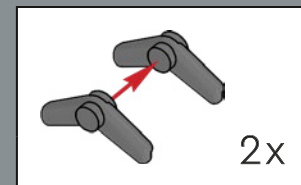

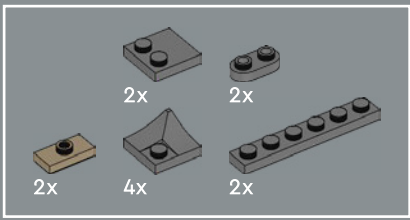

287

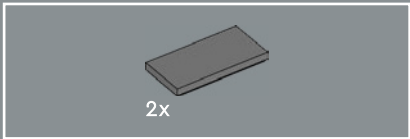
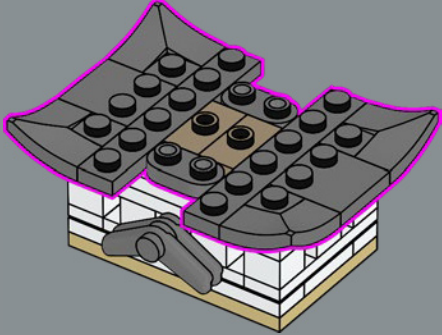

288

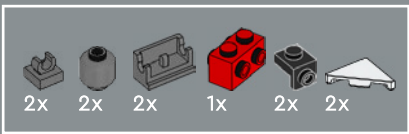
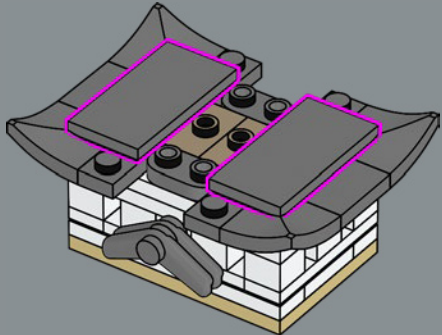

289

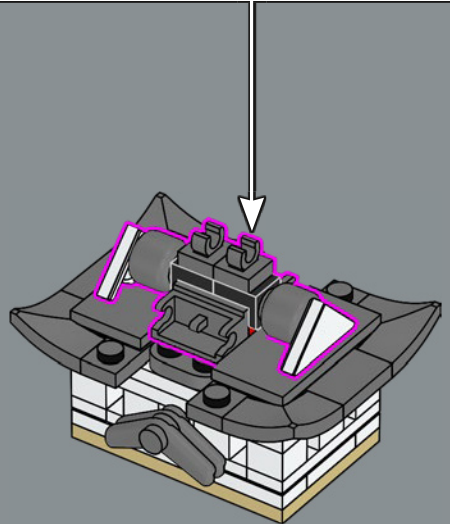
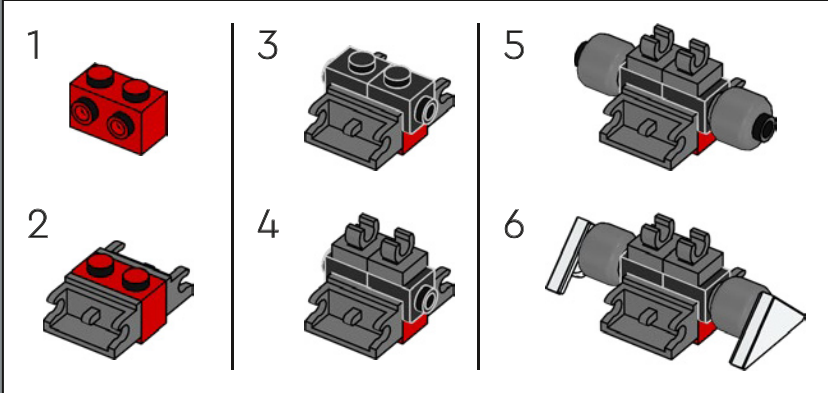

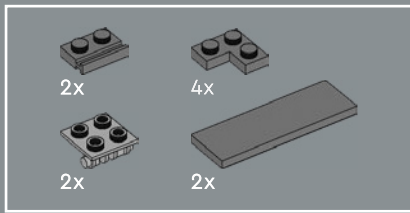

290

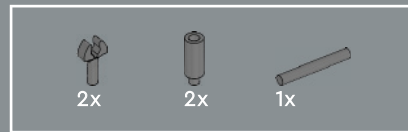
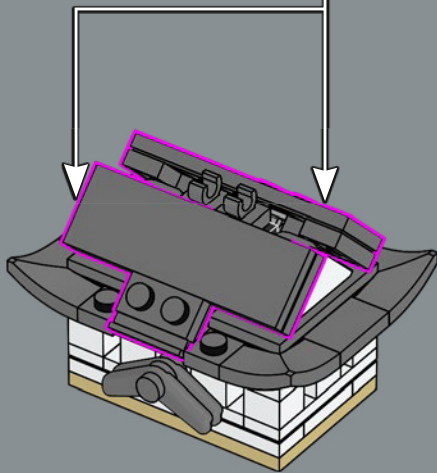
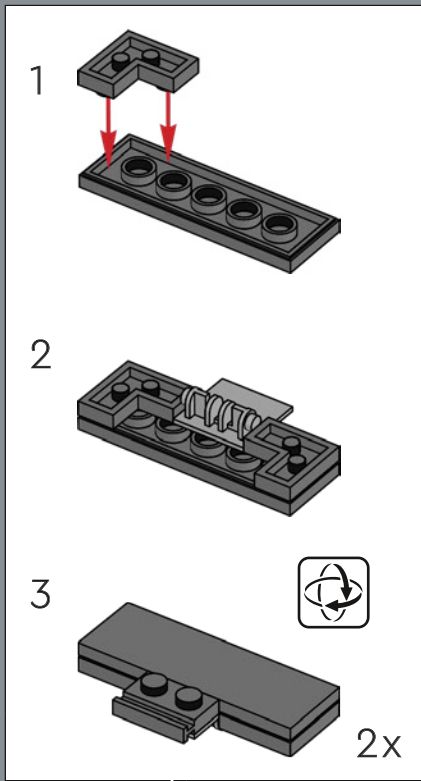

291

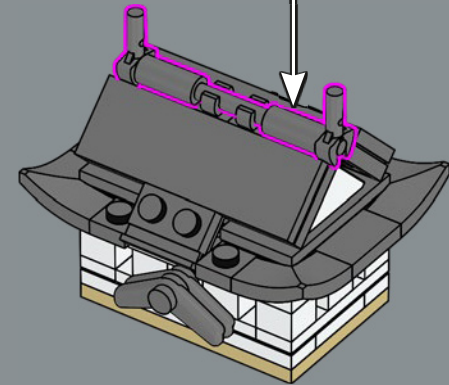
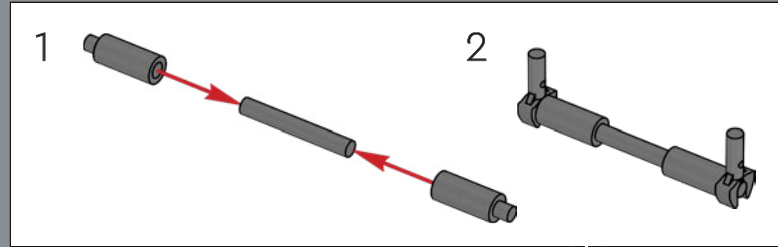

Le tegole del tetto del maschio principale sono state sostituite durante la ristrutturazione del 2009-2015. Le nuove tegole più sottili pesano 0,75 kg in meno rispetto alle tegole originali, rendendo l'intero tetto più leggero di oltre 45 tonnellate!

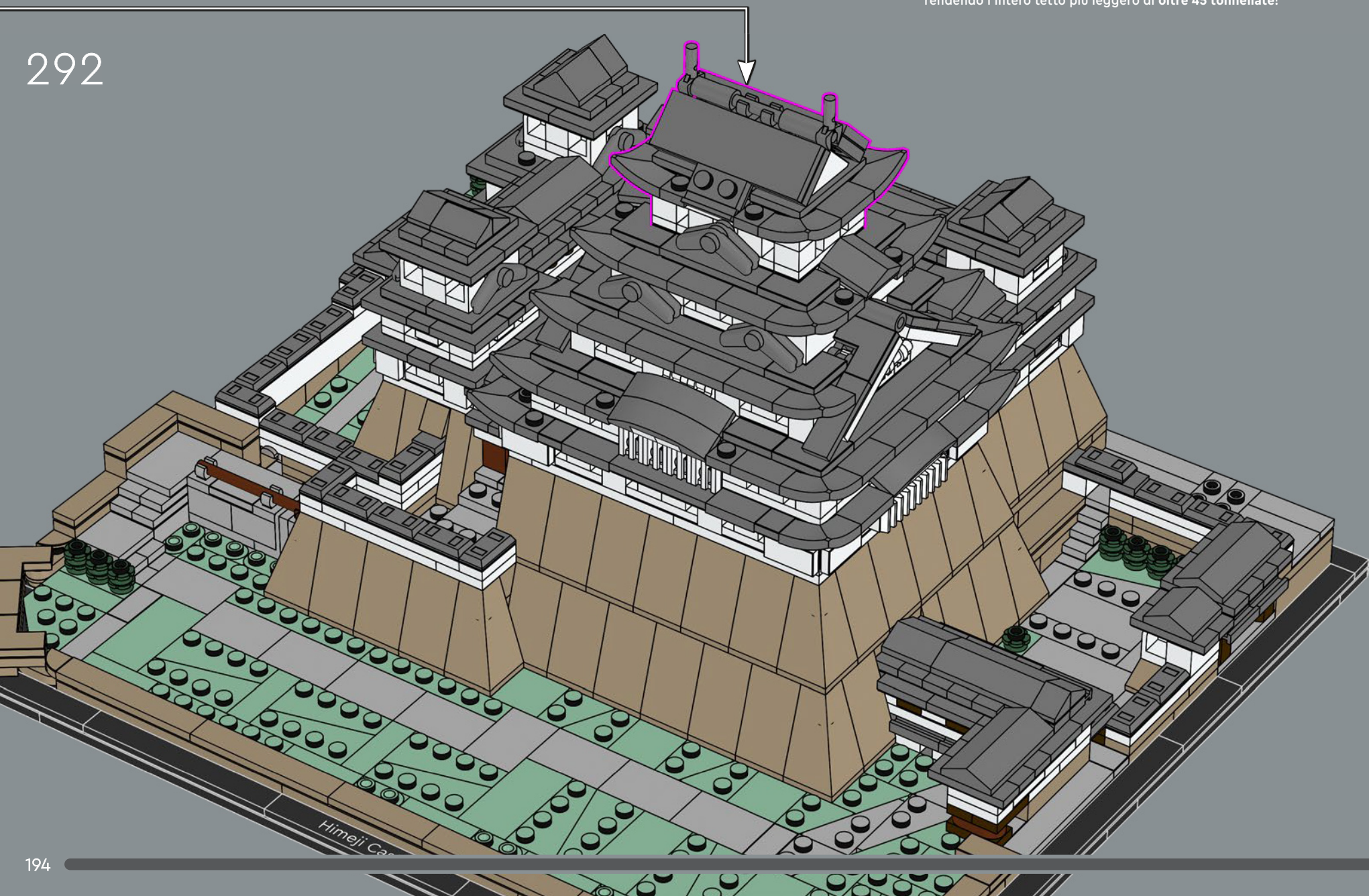



293

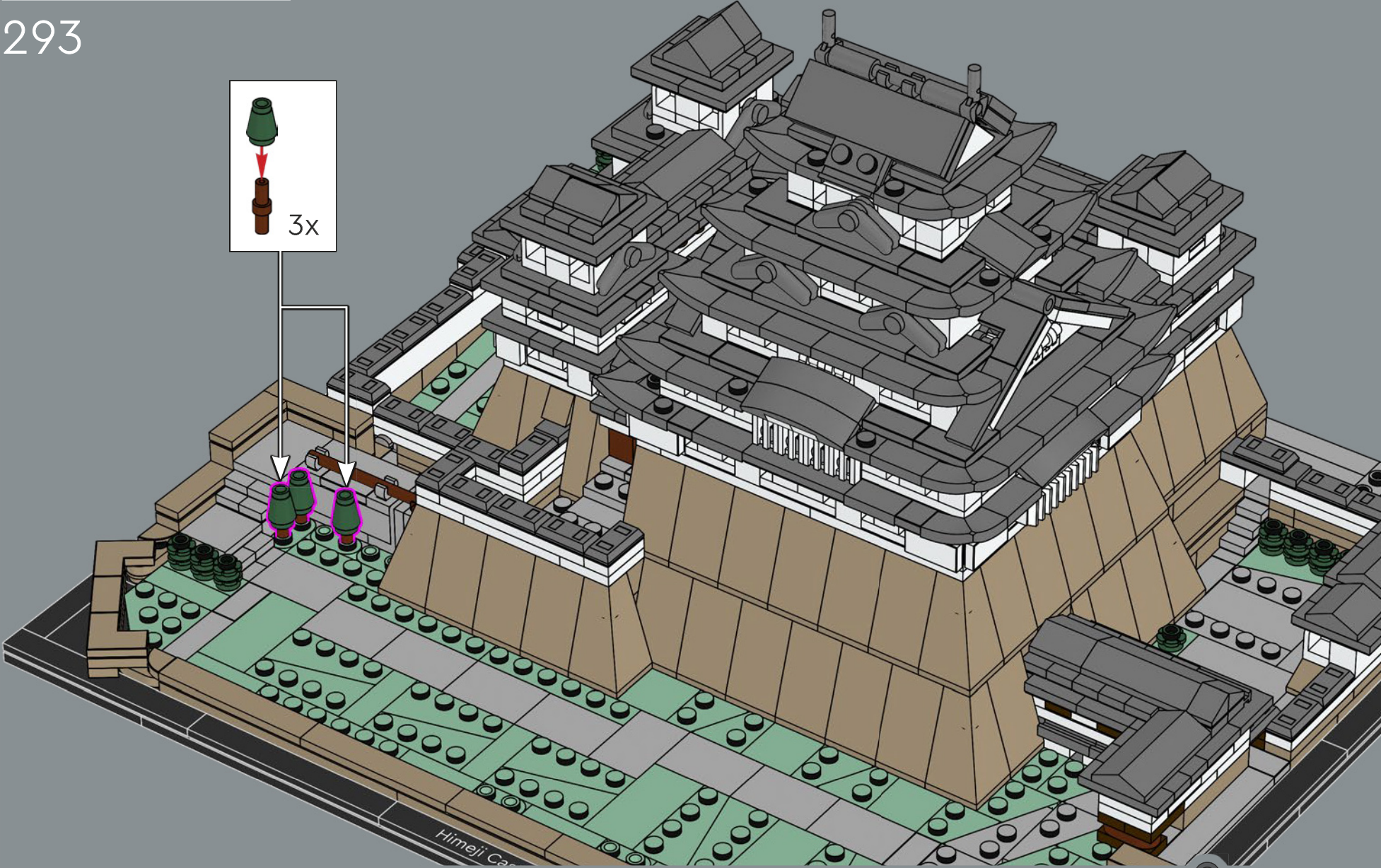
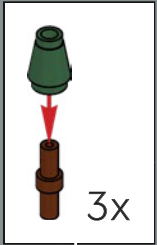

Himeji Castle





294

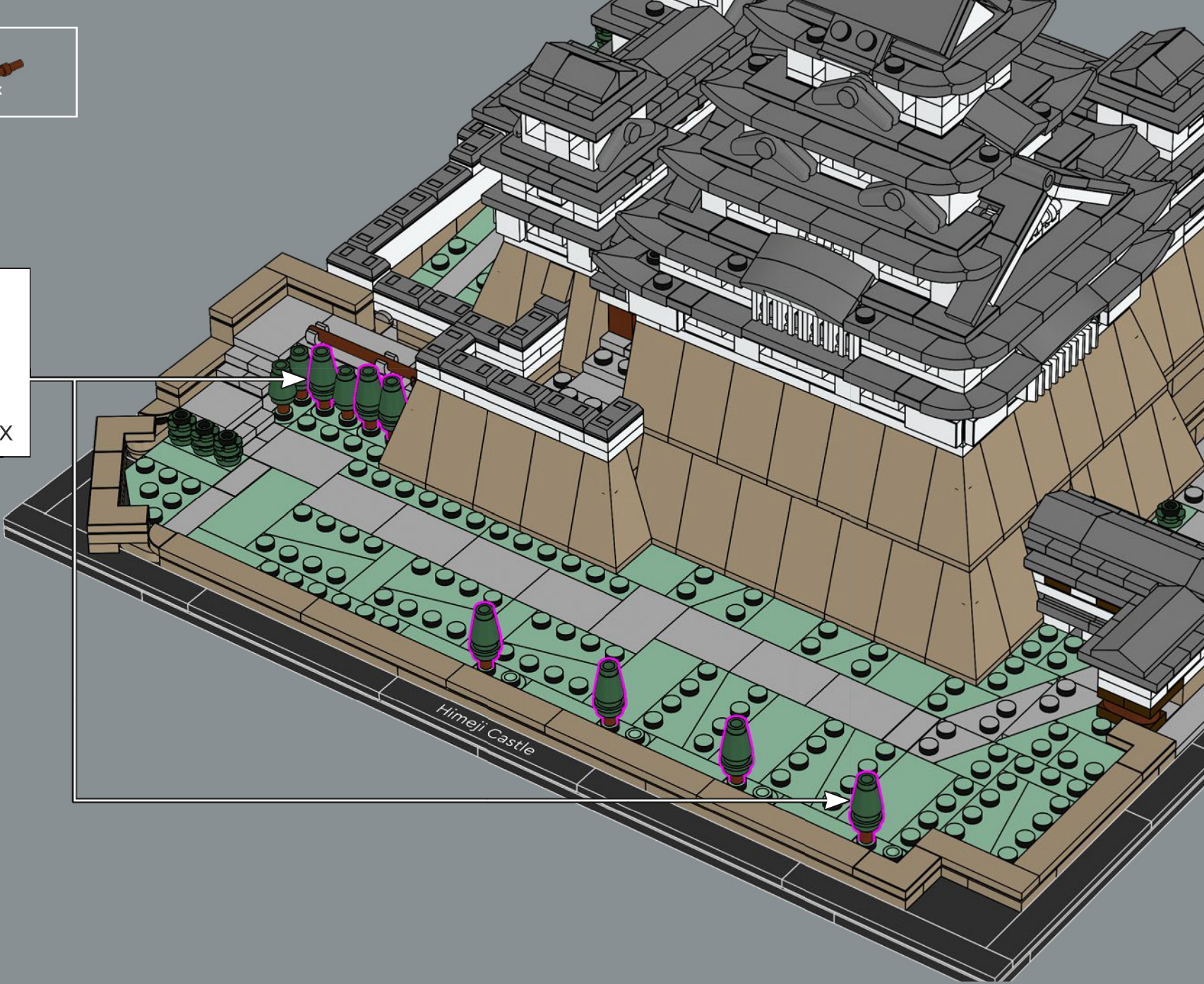
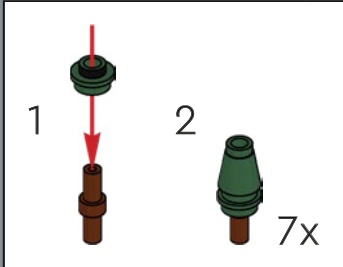

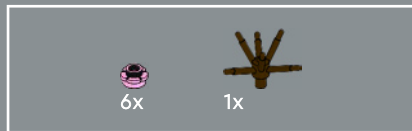

295

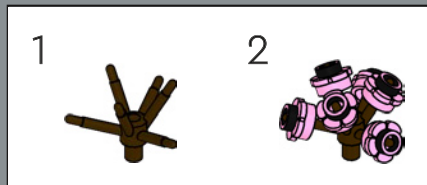

3x

296

3x

Himeji Castle

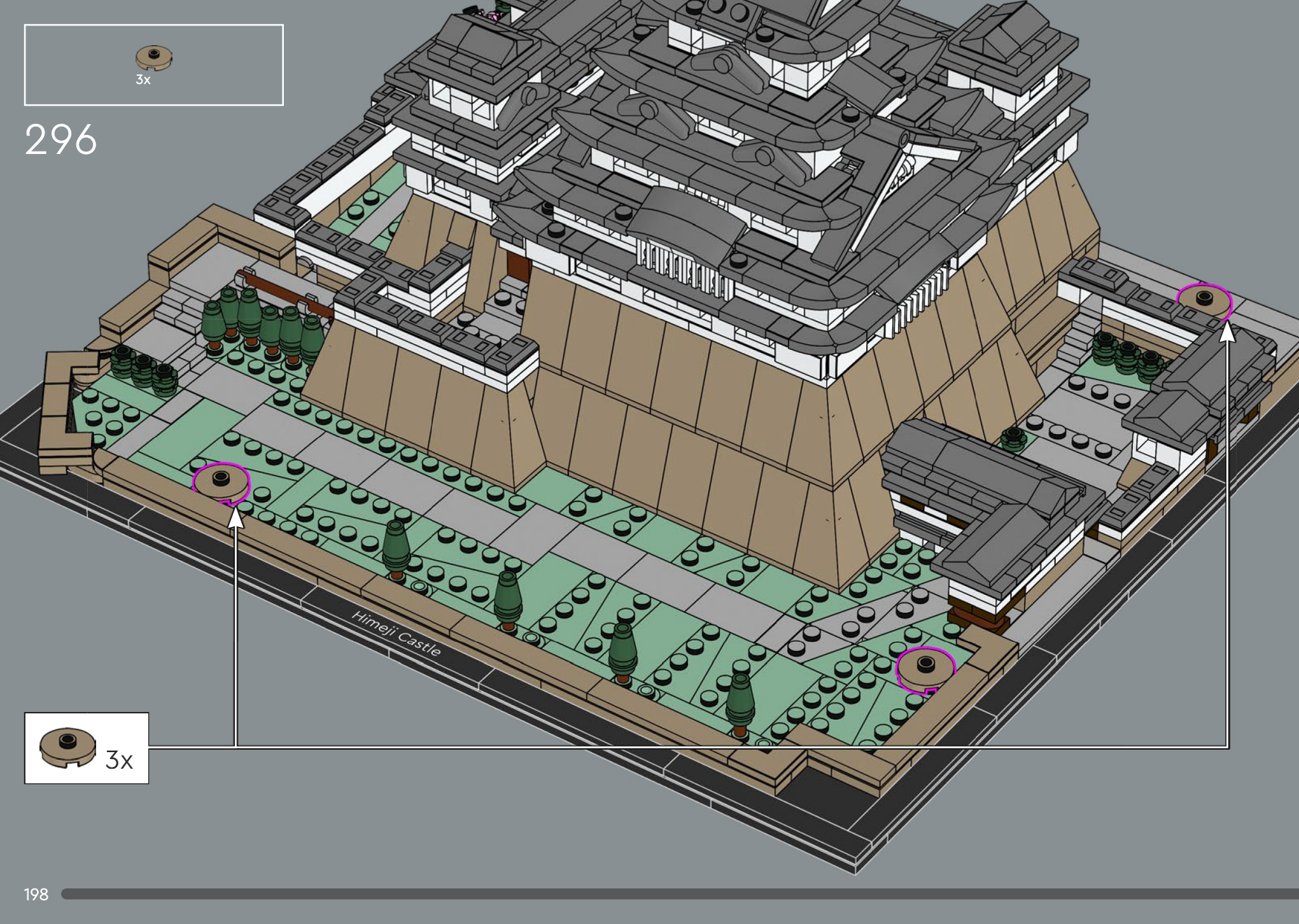

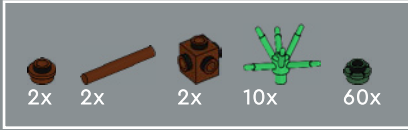
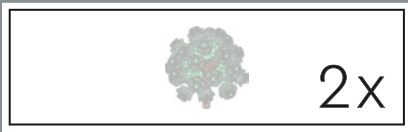

297

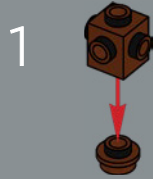
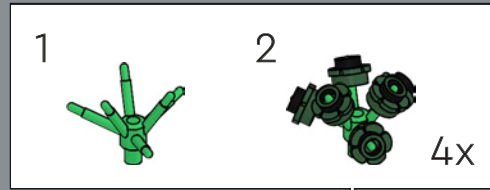
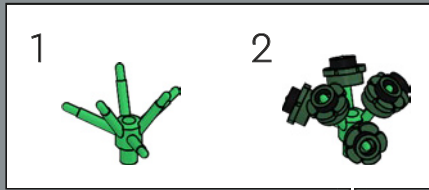

2x





298

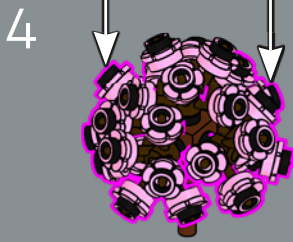
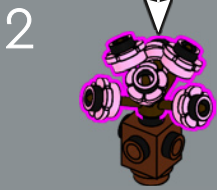
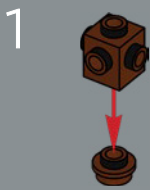
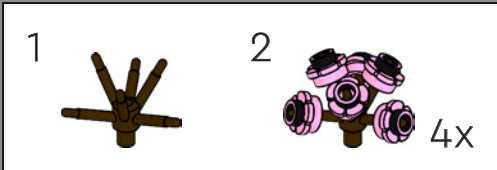
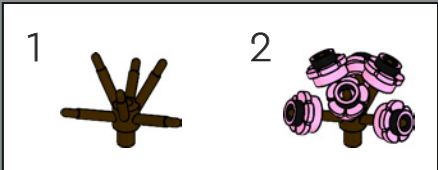



Himeji Castle



299

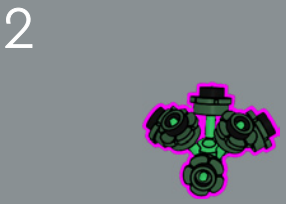
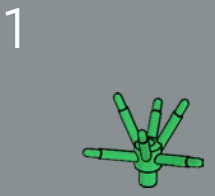
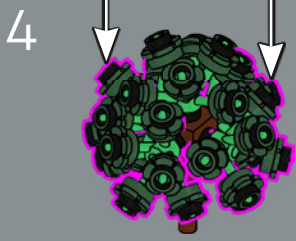
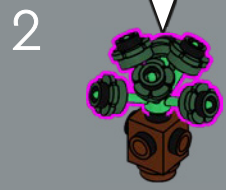
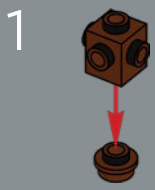
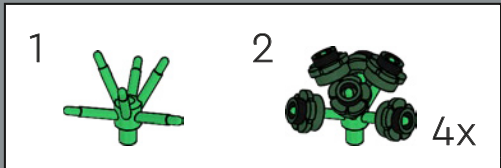
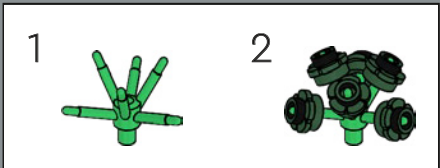

Il Castello di Himeji è conosciuto anche come "airone bianco", in quanto ricorda il maestoso uccello che sta per spiccare il volo.

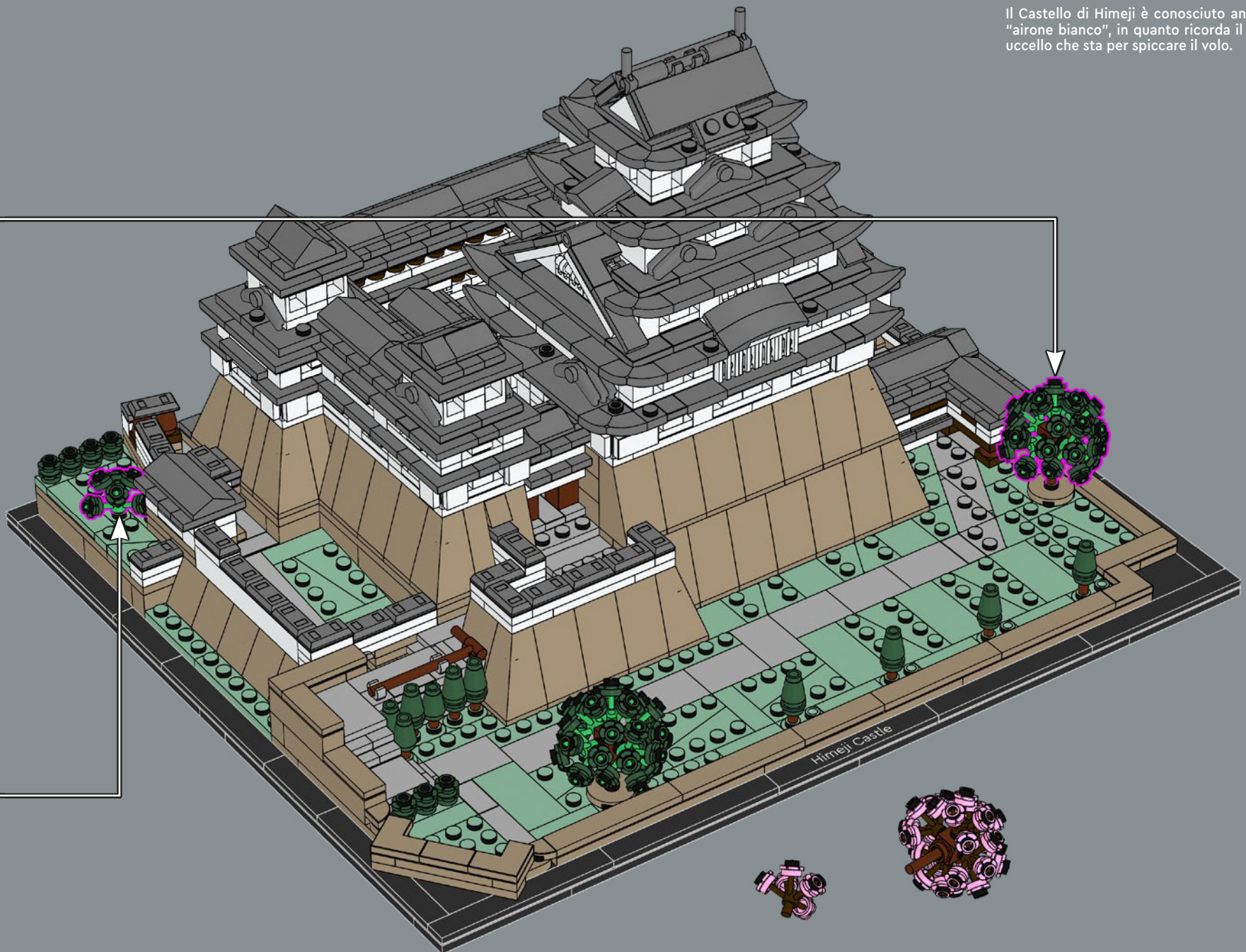

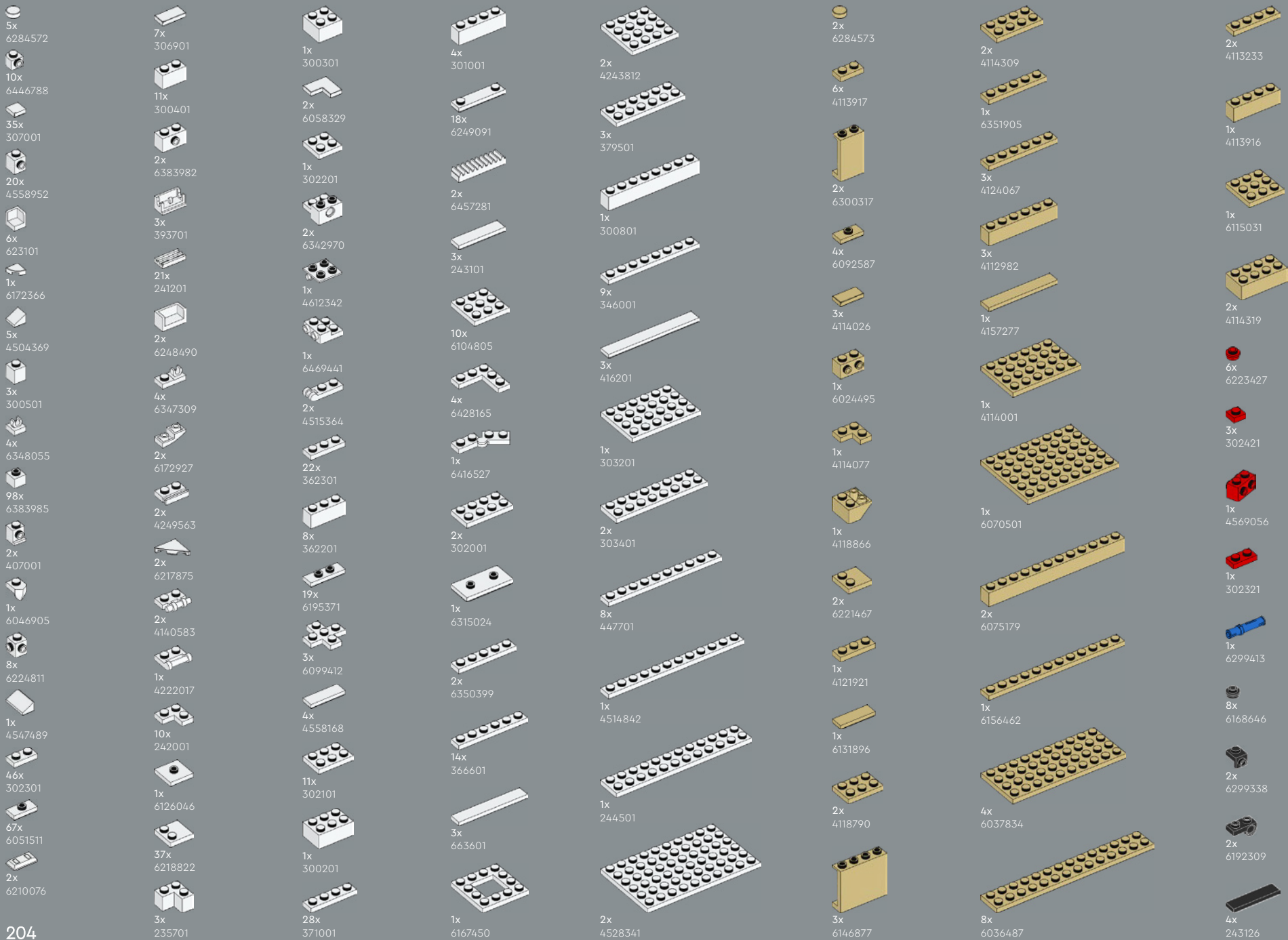

- 2x 302026
- 2x 617926
- 6x 379526
- 15x 416226
- 1x 6454242
- 1x 6454243
- 4x 395826
- 6x 303326
- 11x 6001494
- 1x 300528
- 16x 6269940
- 1x 4181135
- 1x 6240515
- 1x 6300322
- 4x 6273590
- 2x 6040126
- 7x 4549436
- 6x 6001824
- 1x 6055172
- 3x 6362967
- 2x 6231386
- 3x 6132767
- 23x 4528604
- 16x 4521914
- 4x 6092591
- 8x 4653509
- 12x 4496699
- 2x 6250168
- 1x 6328477
- 38x 6000852
- 5x 4616593
- 11x 6436361
- 4x 6398654
- 2x 6047415
- 8x 4255416
- 12x 4550168
- 2x 6310830
- 2x 4507045
- 2x 6126075
- 11x 6132768
- 5x 6015452
- 5x 6035540
- 1x 6328307
- 4x 4626904
- 9x 6175927
- 9x 6001822
- 10x 4247145
- 4x 4267874
- 3x 6164288
- 11x 4507047
- 16x 6015424
- 15x 4247151
- 3x 6156492
- 3x 6167894
- 14x 4246957
- 4x 6232137
- 1x 6096215
- 121x 6446790
- 10x 6411591
- 7x 6230571
- 1x 6099189
- 14x 6247894
- 8x 6303004
- 15x 6258333
- 2x 4616578
- 2x 6184432
- 3x 4655080
- 3x 6133896
- 3x 6423384
- 12x 6202626
- 2x 6069257
- 1x 6416003
- 4x 6100234
- 1x 6192923
- 4x 4633693
- 4x 6099187
- 4x 6186673
- 2x 4529242
- 4x 6215659
- 15x 4211288
- 11x 4211242
- 1x 4221744
- 1x 6348057
- 1x 6214343
- 1x 6238874
- 4x 6133765
- 4x 6248944
- 10x 6451002
- 3x 6261744
- 4x 4211150
- 4x 4211149
- 5x 4211151
- 1x 6092590
- 4x 6428805
- 4x 4211200
- 2x 4211210
- 1x 6221608
- 1x 4565394
- 6x 4508616
- 1x 4211189
- 10x 4211190
- 7x 6257604
- 3x 4211225
- 1x 4211186
- 7x 4221590
- 4x 4211193
- 4x 4216615
- 12x 4585337
- 2x 6313665
- 2x 6055145
- 2x 4211220
- 4x 4211152
- 1x 6251470
- 2x 4211415
- 2x 6308012
- 2x 6306729
- 2x 6163478
- 1x 4211732
- 13x 4211414
- 4x 4211398
- 16x 6066097
- 4x 4211350
- 2x 6092111
- 1x 4654580
- 2x 6065824

- 1x 6126082
- 1x 4211397
- 2x 4211349
- 1x 4211413
- 4x 4211881
- 1x 6438836
- 12x 4558169
- 12x 6211969
- 3x 4211429
- 16x 6171894
- 2x 4211356
- 5x 6257593
- 2x 4211445
- 5x 4560183
- 2x 4211395
- 1x 4211385
- 2x 4211549
- 4x 4211795
- 5x 4211481

- 1x 4211407
- 4x 4211408
- 6x 4211405
- 6x 4662161
- 4x 6058221
- 6x 6452882
- 1x 6252667
- 2x 6226792
- 1x 6223039
- 36x 6212501
- 4x 6388120
- 4x 4529240
- 2x 6439040
- 1x 4211407
- 4x 4211408
- 6x 4211405
- 4x 6058221
- 6x 6452882
- 1x 6252667
- 2x 6226792
- 1x 6223039
- 36x 6212501
- 4x 6388120
- 4x 4529240
- 2x 6439040

- 2x 6192569
- 2x 6395635
- 4x 4210848
- 9x 4210719
- 2x 6344022
- 6x 4504378
- 2x 6199549
- 2x 6221607
- 4x 6388119
- 1x 4226221
- 6x 4567887
- 29x 6331866
- 20x 6092572
- 12x 4211063
- 6x 4211052
- 2x 4211066
- 2x 4211135

- 3x 6000606
- 9x 4543086
- 20x 6446785
- 1x 6310596
- 12x 6126083
- 6x 6446786
- 1x 4211094
- 43x 6309059
- 2x 4210702
- 18x 6247784
- 1x 6232193
- 21x 6447212
- 4x 4210635
- 1x 4211055
- 60x 6343852
- 8x 4568734

- 1x 4211043
- 3x 6187008
- 4x 4211053
- 3x 4648256
- 2x 6039176
- 41x 6307616
- 6x 4560184
- 3x 4211127
- 10x 6189120
- 4x 4210651
- 2x 4211056
- 2x 6321746
- 1x 6230281

- 2x 4210998
- 1x 4211008
- 1x 4210997
- 1x 4211061
- 2x 6133611
- 1x 6000970
- 1x 6231376
- 2x 6215447
- 3x 6093529
- 25x 6315780
- 3x 6259071
- 4x 6194729
- 3x 4519970



 [LEGO.com/service](https://www.LEGO.com/service)



YOU COULD WIN



YOU COULD WIN

Your feedback will help shape the future development of this product series.

Visit:

DU KÖNNTEST GEWINNEN

Dein Feedback trägt zur Weiterentwicklung dieser Produktreihe bei.

Geh auf:

VOUS POURRIEZ GAGNER

Vos commentaires nous aideront à concevoir les futurs produits de cette gamme.

Visitez :

POTRESTI VINCERE TU

La tua opinione ci aiuterà a migliorare la creazione futura di questa linea di prodotti.

Visita:

PUEDES GANAR

Tu opinión contribuirá al futuro de esta serie de productos.

Visita:

轻松获奖

您的反馈将有助于我们在今后改进本产品系列。

请访问:

[LEGO.com/productfeedback](https://www.lego.com/productfeedback)

You also have the chance to win a LEGO® set.

Terms and conditions apply.*

Außerdem hast du die Chance, ein LEGO® Set zu gewinnen.

Es gelten die Teilnahmebedingungen.*

Vous pourriez également gagner un ensemble LEGO®.

Des conditions s'appliquent.*

Hai anche la possibilità di vincere un set LEGO®.

Termini e condizioni sono applicabili.*

También tienes la oportunidad de ganar un set LEGO®.

Aplican términos y condiciones.*

您还有机会赢取乐高®套装。

条款和条件适用。*

*[LEGO.com/productfeedback-terms](https://www.lego.com/productfeedback-terms)

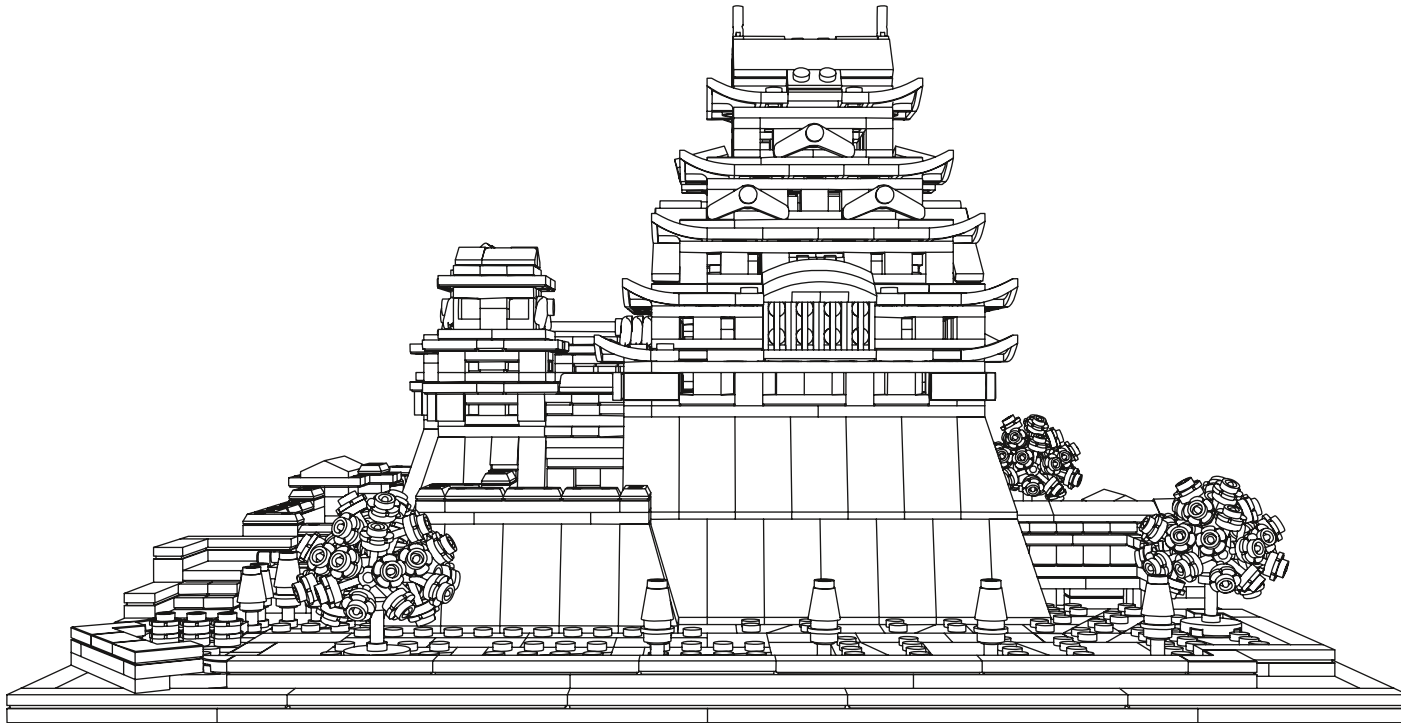

LEGO and the LEGO logo are trademarks of the LEGO Group. ©2023 The LEGO Group.

Adam Reed Tucker is the co-developer of the LEGO® Architecture product line.