



Official Licensed
Product





TRANSPORTER VOLKSWAGEN T2

Desiderando ampliare la propria gamma di veicoli alla fine degli anni '40, la Volkswagen ebbe l'idea di creare un transporter, un furgone da trasporto leggero, utilizzando la piattaforma e il motore del Maggiolino Tipo 1. Nei design iniziali, il conducente era posizionato molto in avanti nel veicolo, il cui carico utile era di 690 kg.

Dopo aver realizzato diversi prototipi e aver modificato il concetto numerose volte, il primo VW Tipo 2 lasciò la linea di produzione di Wolfsburg nel marzo 1950. La seconda generazione del Tipo 2 seguì nel 1967.

V O L K S W A G E N



IL SIMBOLO DELLA CONTROCULTURA

Con il suo basso costo e la facile manutenzione, oltre alla sua capacità di movimentare comodamente grandi gruppi di persone e attrezzature, il VW Tipo 2 divenne presto un'icona della controcultura degli anni '60. Il design del transporter era semplice ma spazioso: poteva essere usato

come abitazione mentre si percorrevano grandi distanze. Il Tipo 2 divenne rapidamente una presenza immancabile ai festival musicali e sulle spiagge preferite dei surfisti, spesso decorato con design stravaganti dai colori vivaci.



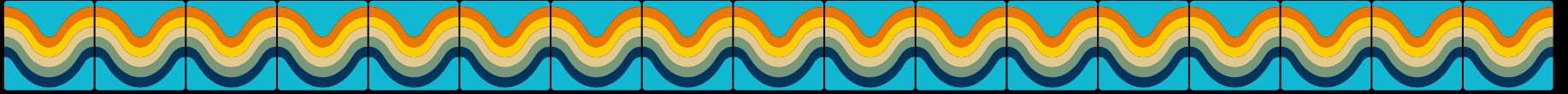

**LA VERSIONE LEGO® DEL CLASSICO
TRANSPORTER VOLKSWAGEN T2
CONTIENE IL MAGGIOR NUMERO
POSSIBILE DI CARATTERISTICHE E
FUNZIONI DEL VEICOLO ORIGINALE... MA
CON QUALCHE SORPRESA!**



Tavola da surf

Portellone posteriore apribile

Motore boxer raffreddato ad aria

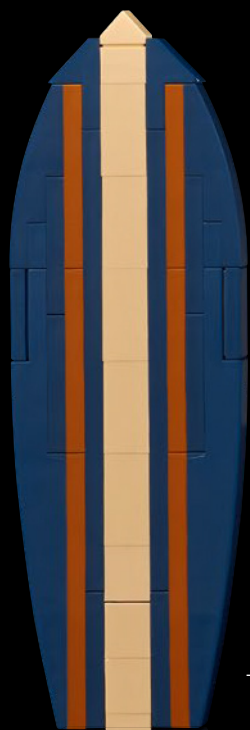
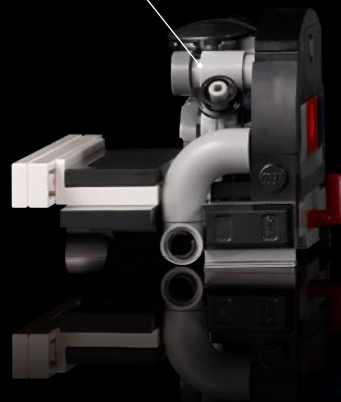

Tendine di tessuto

Tetto-tenda sollevabile





Interno da campeggio con letto "rock 'n' roll" e tavolo apribile

Cucina da campeggio completa con fornello a gas, lavello e frigorifero

Sterzo funzionante

Sedie da campeggio pieghevoli

Portellone laterale scorrevole

Portiere apribili

LEGO® VOLKSWAGEN

Questo nuovo modello è l'ultimo di una serie di set LEGO®, vecchi e nuovi, che celebrano una lunga storia tra le due società. I primi modelli VW pre-stampati arrivarono negli anni '50, ancora prima

del lancio del sistema LEGO. Furono seguiti da famosi veicoli Volkswagen come il Maggiolino Tipo 1 nel 2008 e nel 2016 e l'originale Autocamper T1 "a parabrezza diviso" del 2011.

1957



307

Showroom VW

2008



10187

Maggiolino Volkswagen LEGO®

2011



10220

Camper Van Volkswagen T1 LEGO

2016



10252

Maggiolino Volkswagen classico LEGO

IL DESIGN TEAM

Essendo un grande fan dei transporter VW T2 e un esperto designer LEGO®, Sven Franic è riuscito a combinare due delle sue più grandi passioni in questo progetto: *"Ho posseduto diversi classici veicoli Volkswagen nella mia vita. C'è qualcosa di inequivocabilmente positivo nell'esperienza di guida di questi veicoli"*.

Per Sven, la sfida più grande è stata progettare tutte le parti apribili del modello in modo che funzionassero insieme: *"Il camper è fondamentalmente un multi-strumento su ruote, tutto si apre nella propria direzione e quindi la progettazione di diversi meccanismi incernierati ha richiesto un po' più di riflessione in questo modello"*.



Il T2 del designer

Designer LEGO®
Sven Franic



[LEGO.com/brickseparator](https://www.lego.com/brickseparator)

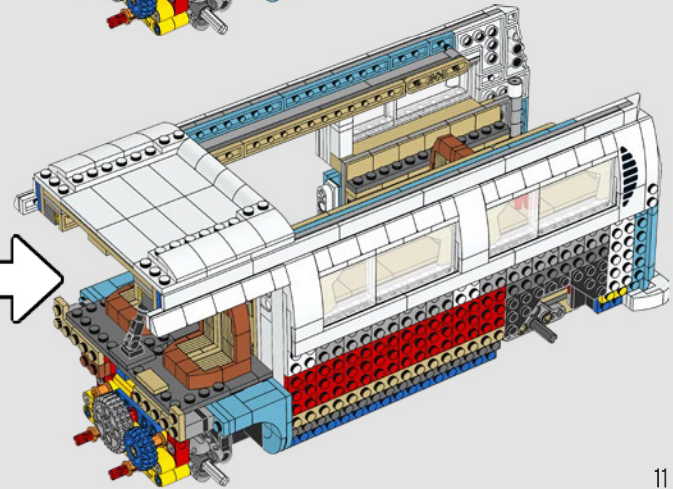
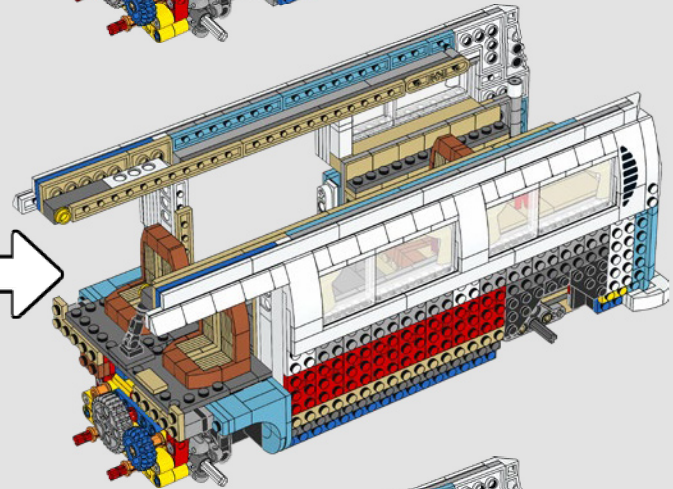
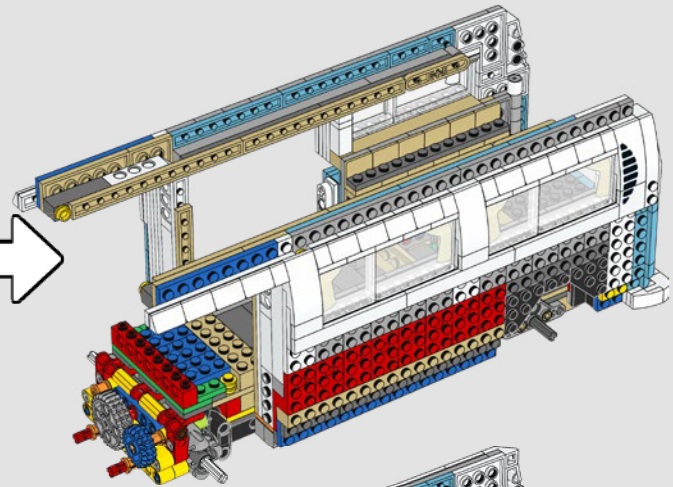
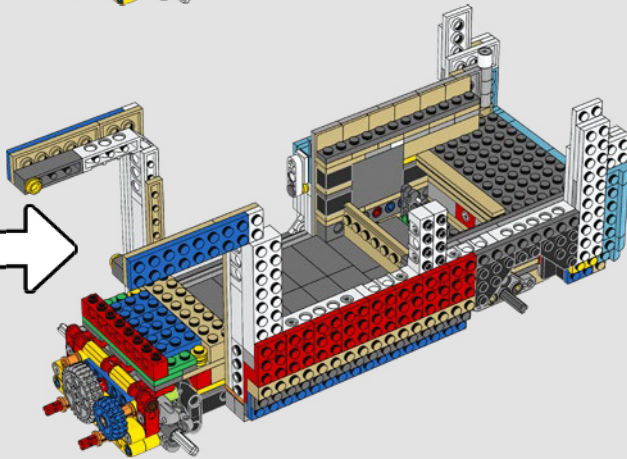
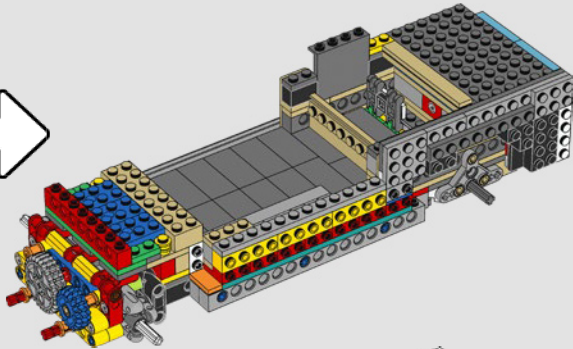
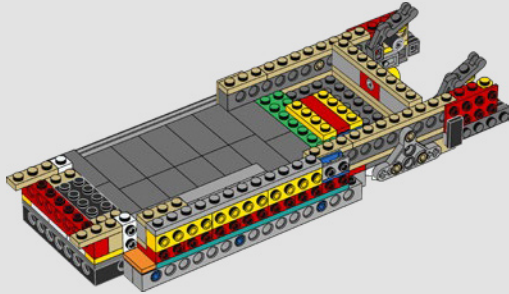

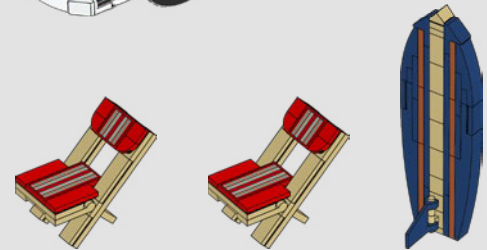
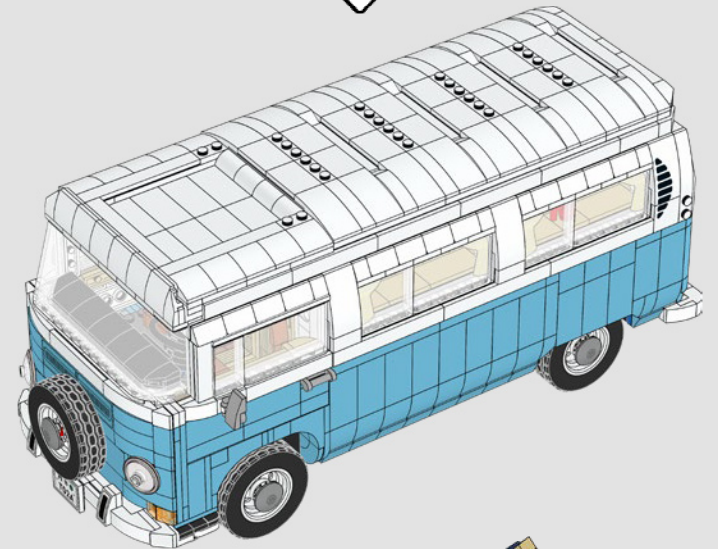
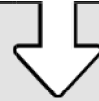
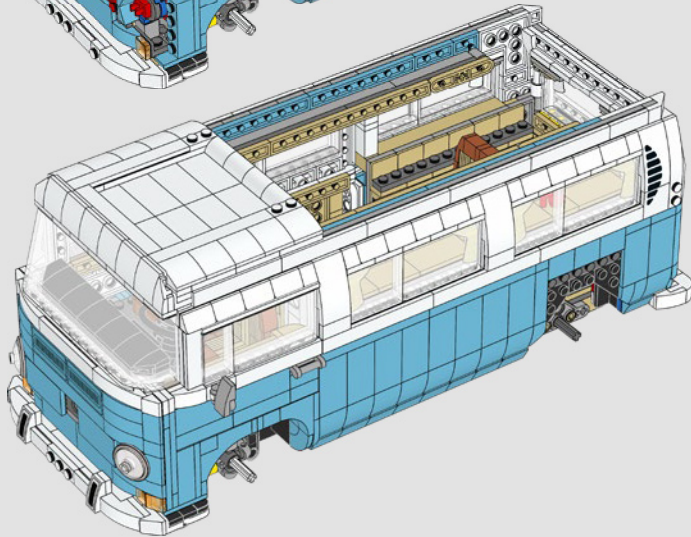
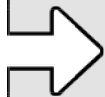
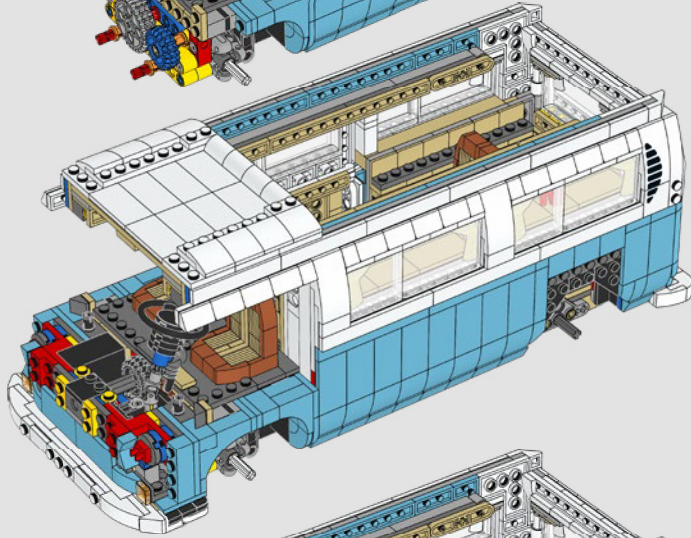
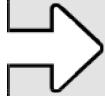
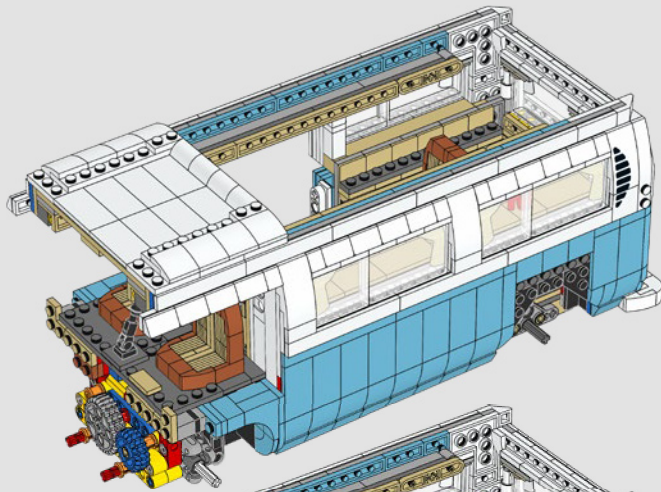
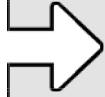

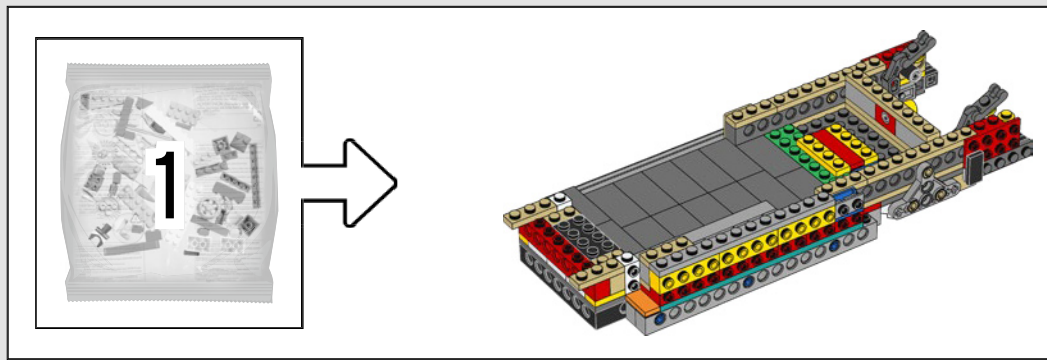

Già negli anni '50, quello che sarebbe poi diventato il tema del Town Plan utilizzava un mix di elementi LEGO® e di modelli di auto VW pre-stampati.

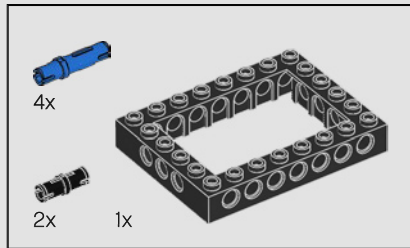

1

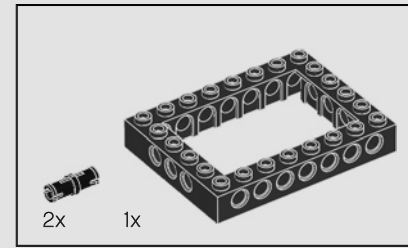
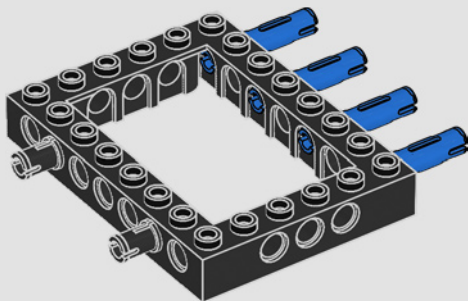

2

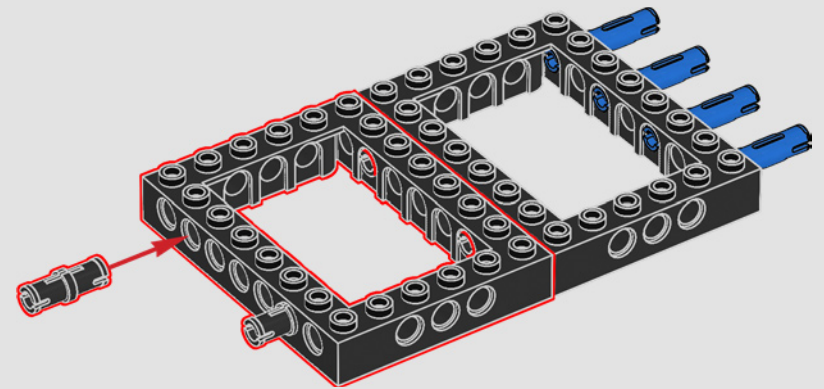

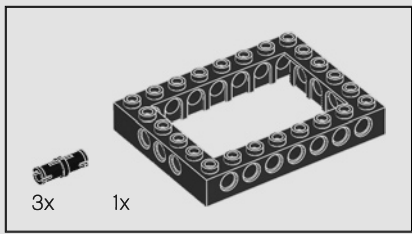

3

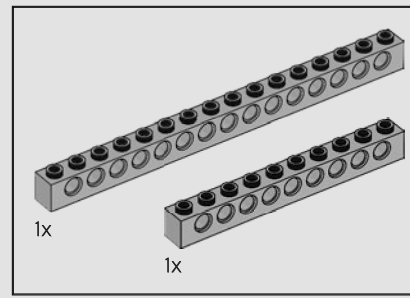
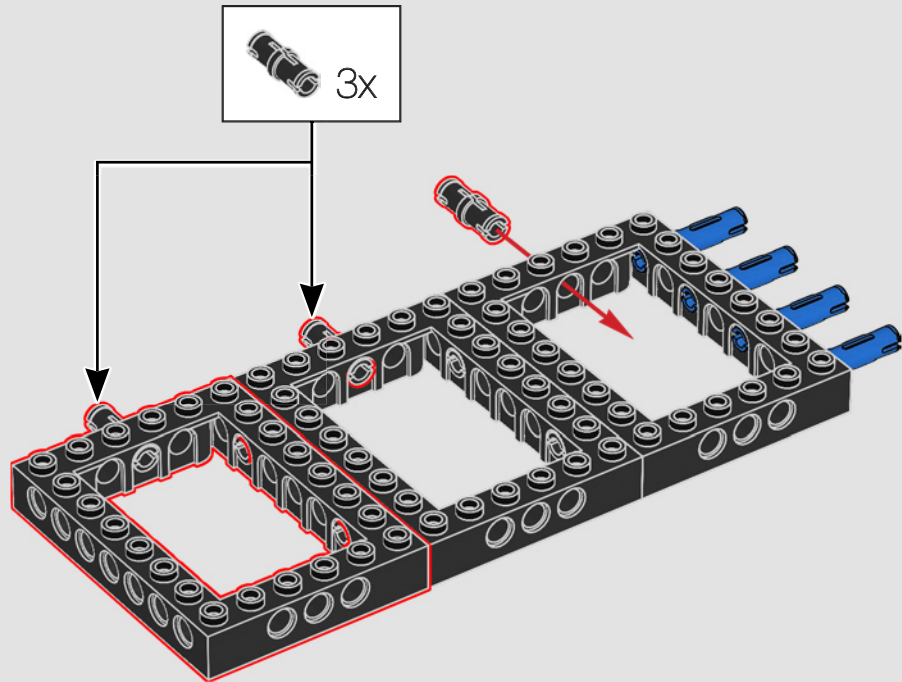

4

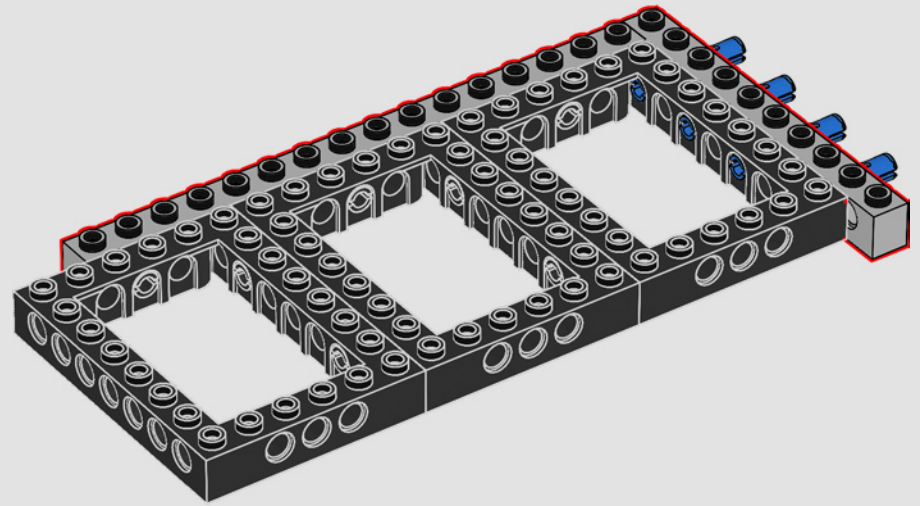

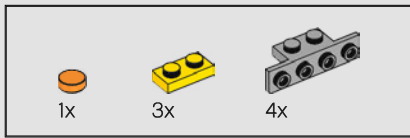

5

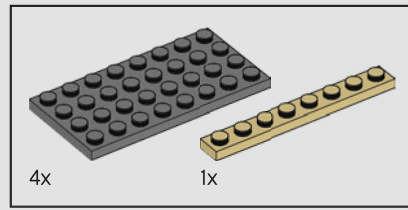
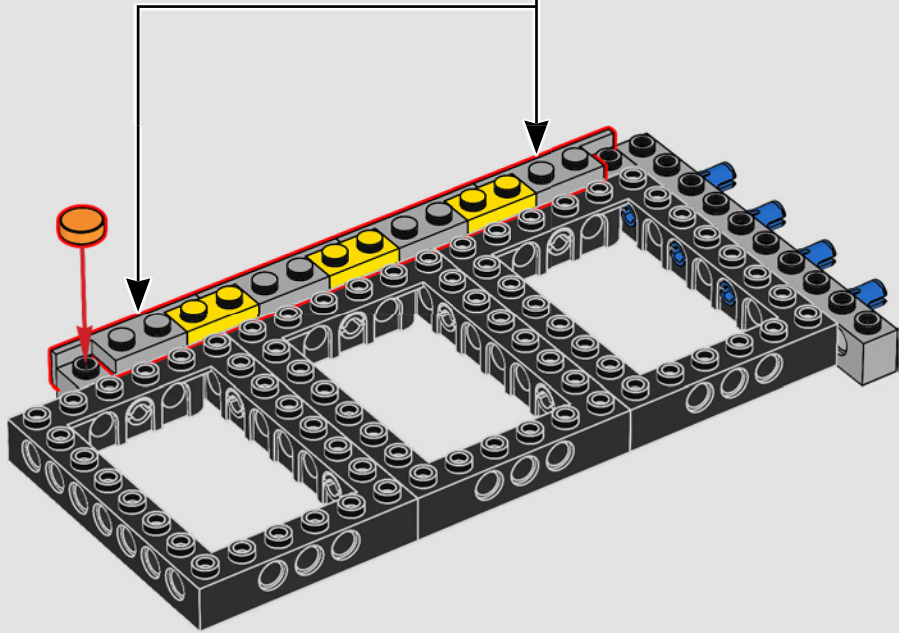
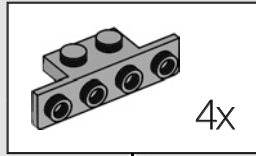

6

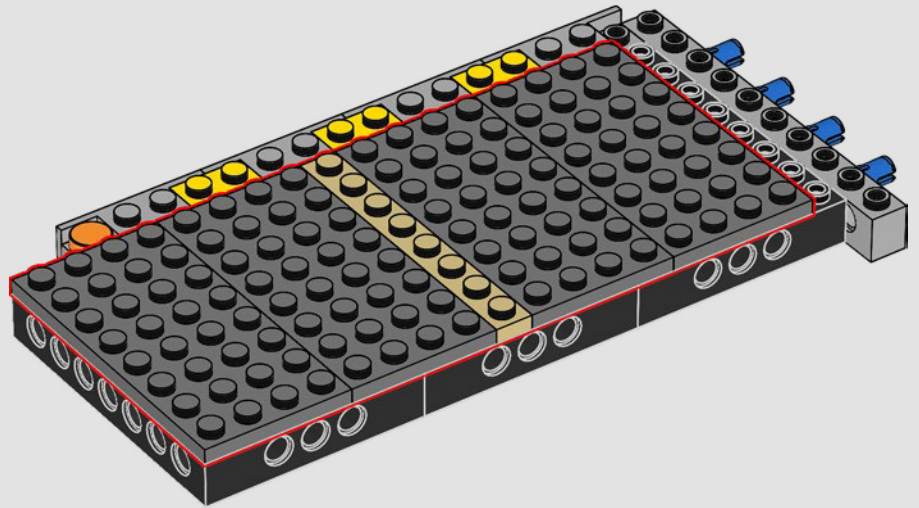

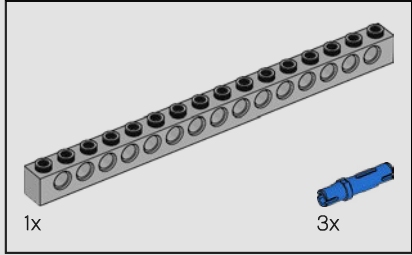
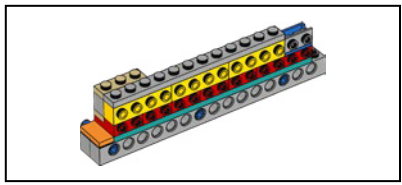

7

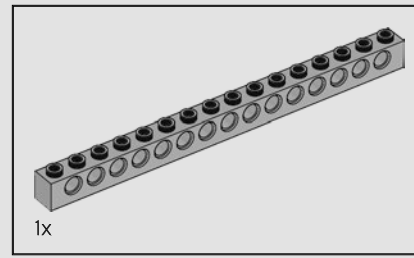
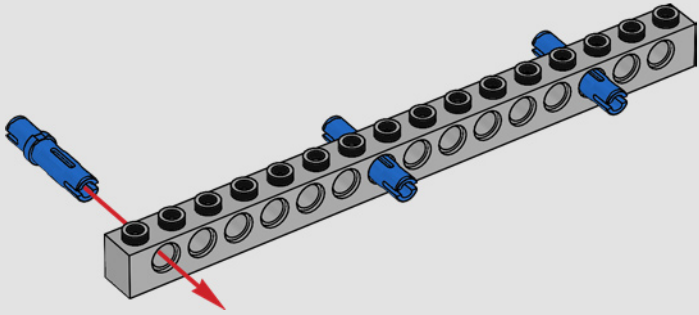

8

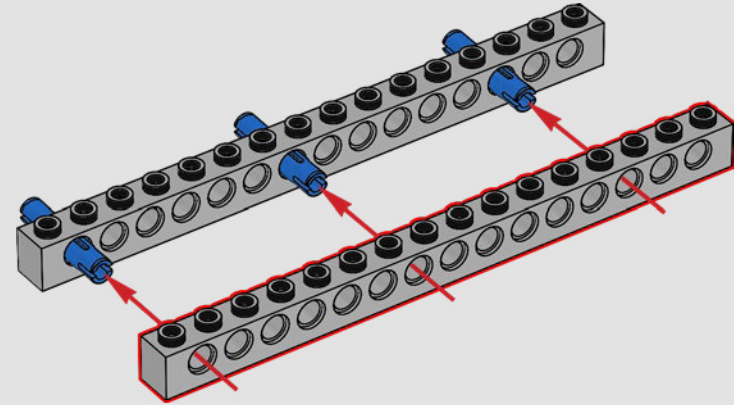

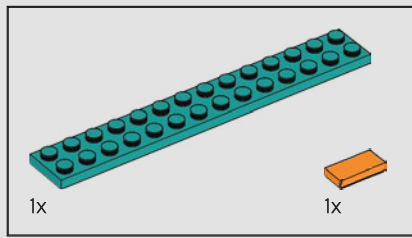

9

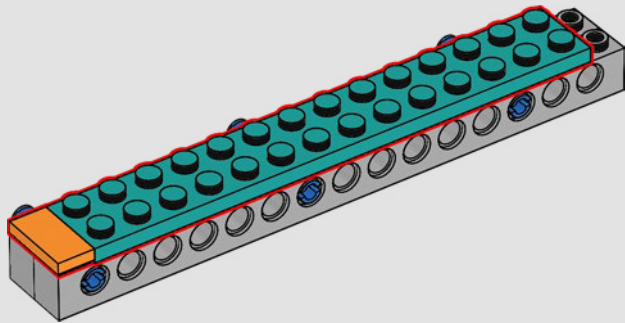

10

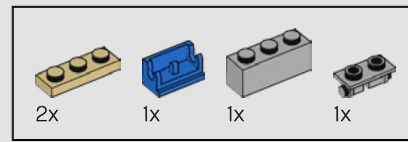
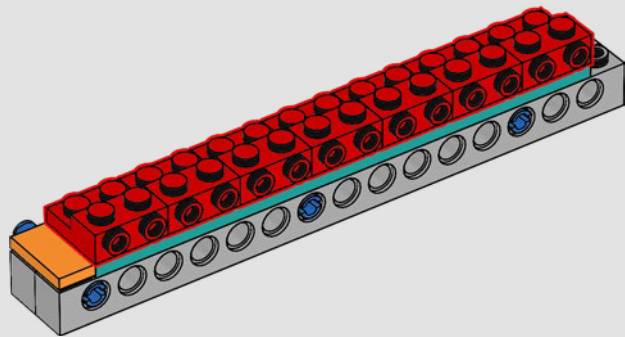

11

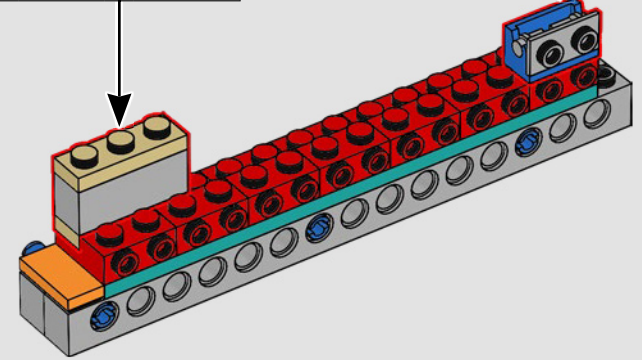
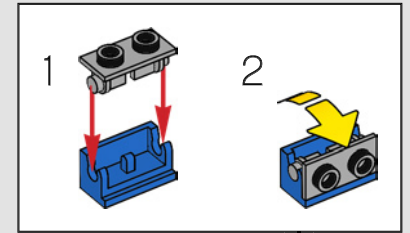
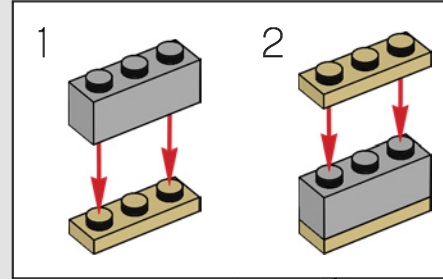
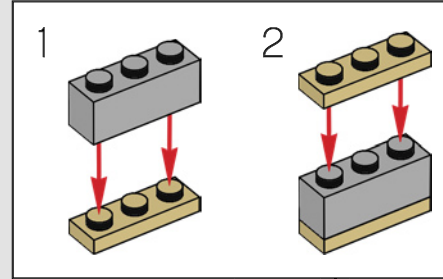

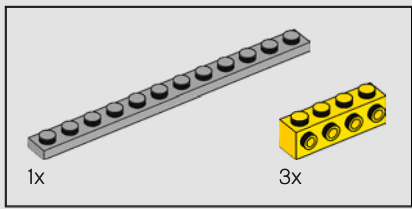

12

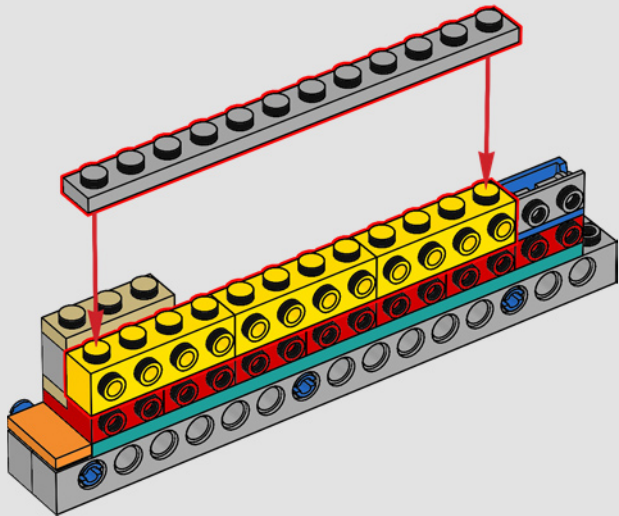

13

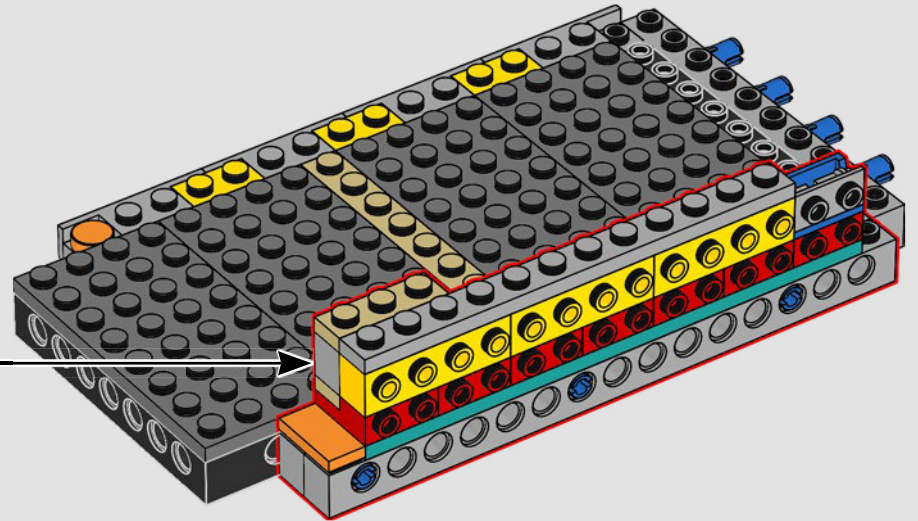

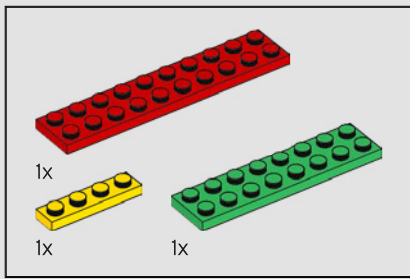

14

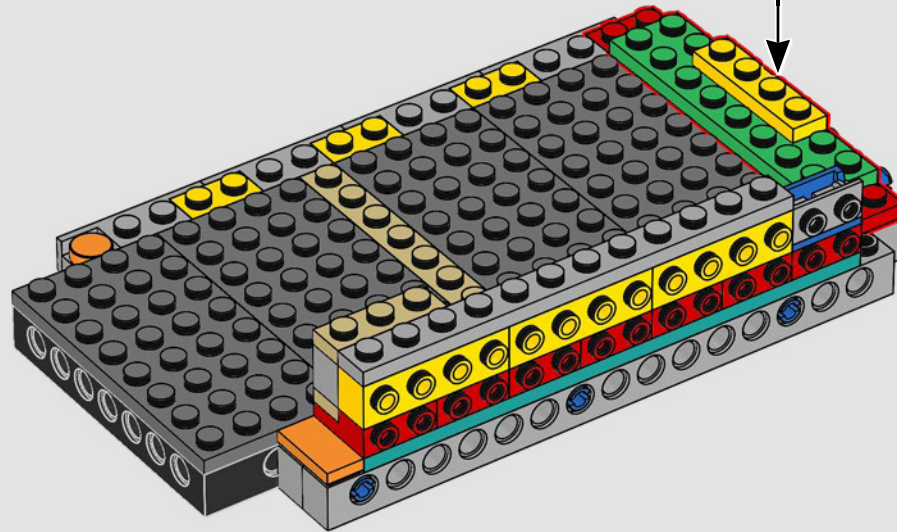
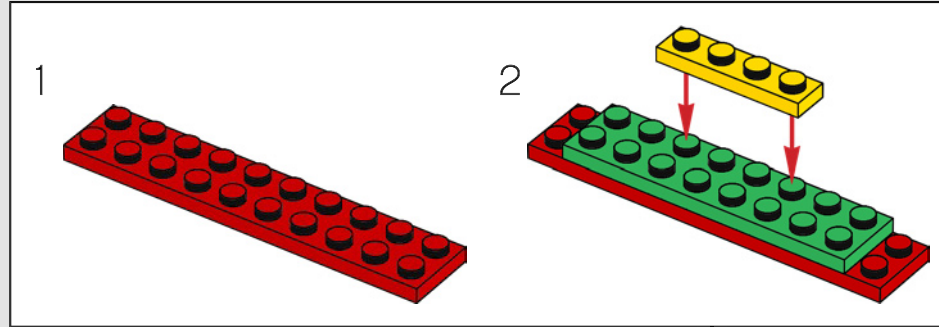

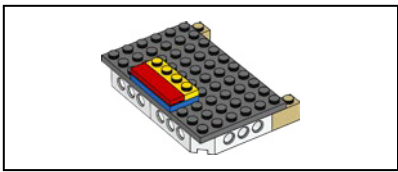

Il set Volkswagen Beetle del 2008 è stato il primo modello di auto di grandi dimensioni della linea Creator. Lo abbiamo scelto dopo aver consultato i fan, proponendo quattro potenziali modelli di auto.

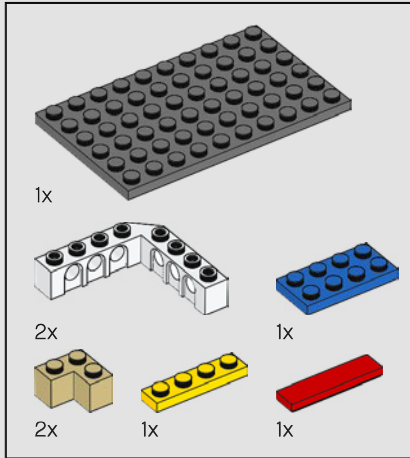

15

1

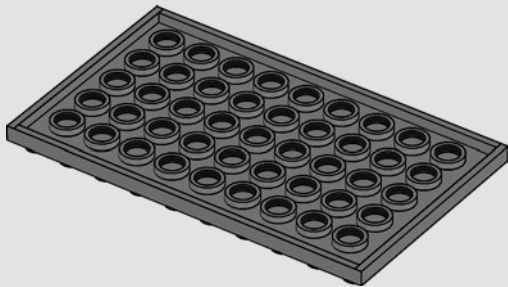

2

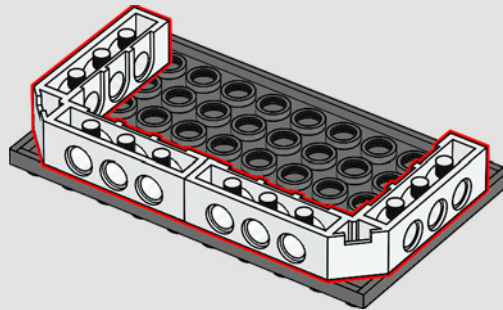

3

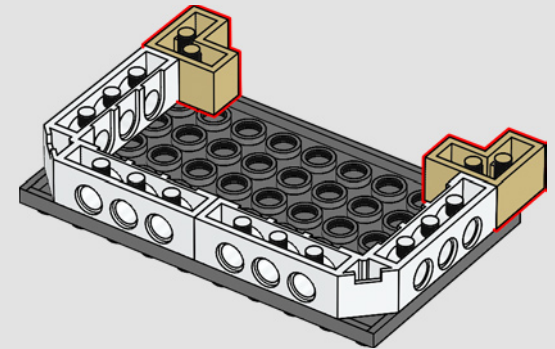



4

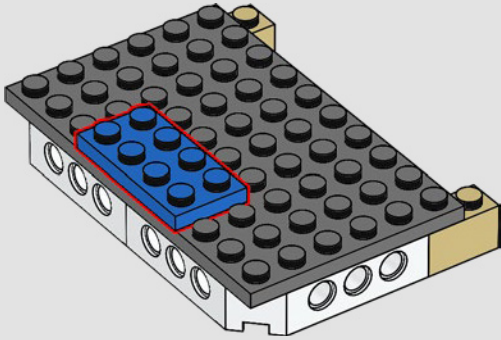

5

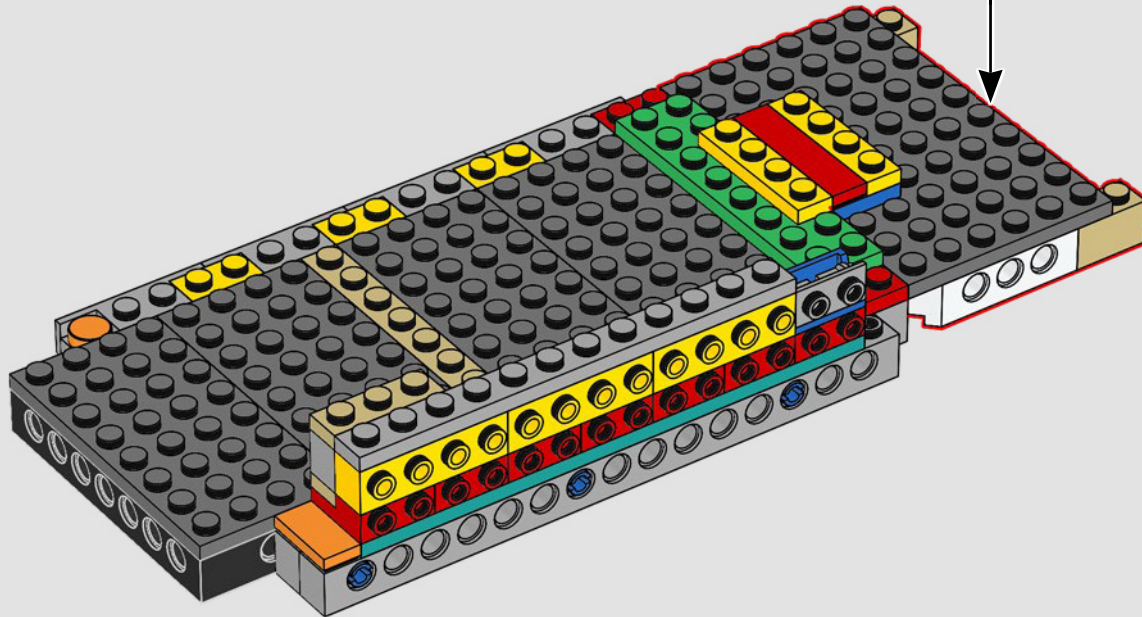
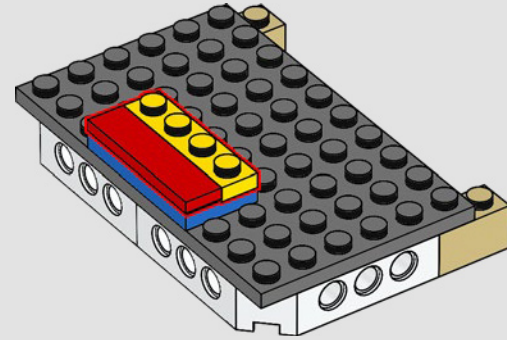

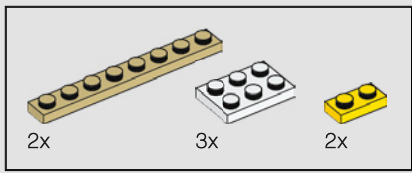

16

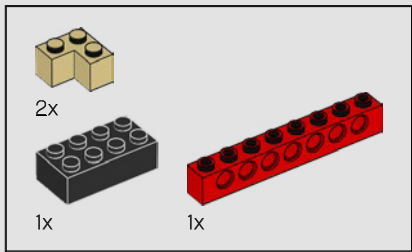
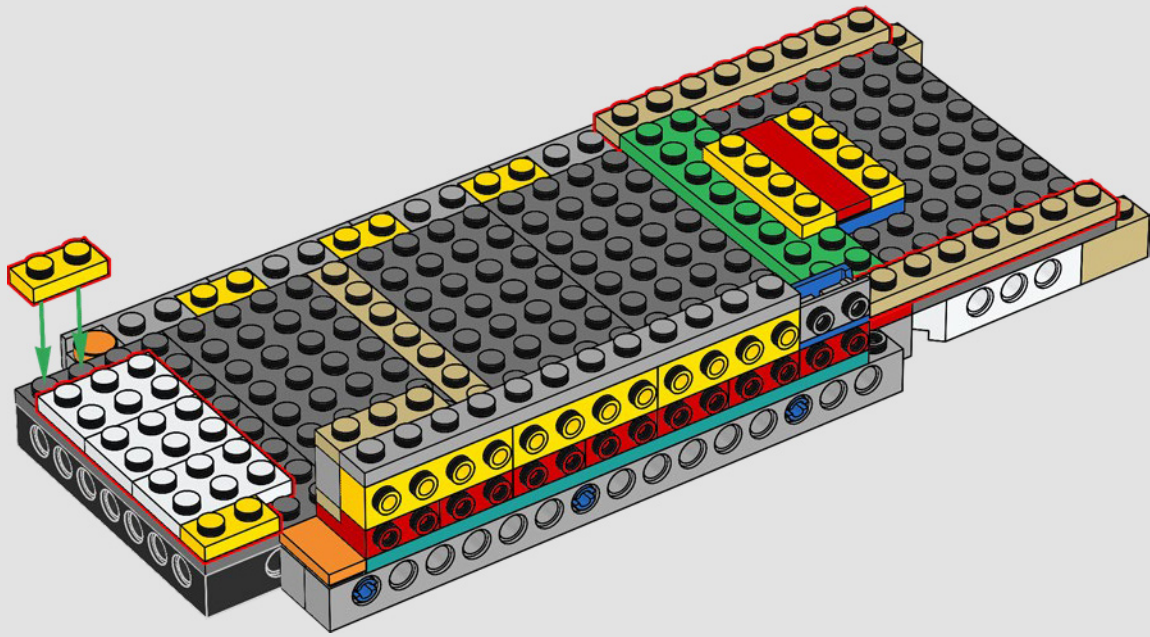

17

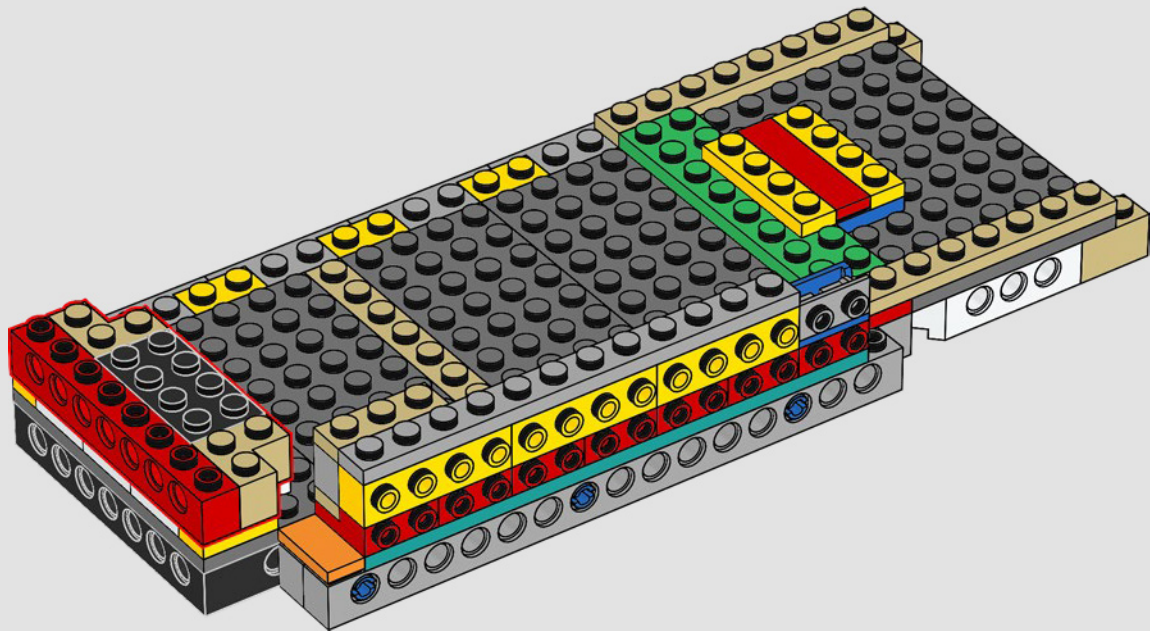

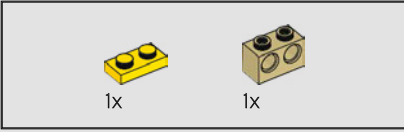
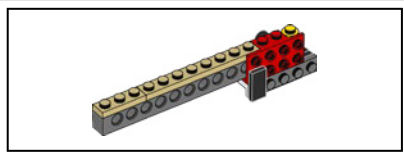

18

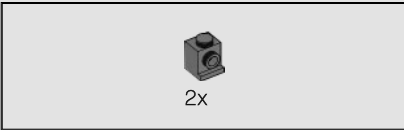
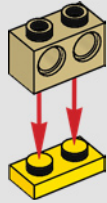

19

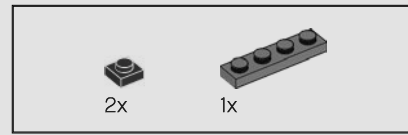
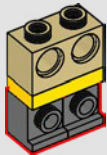

20

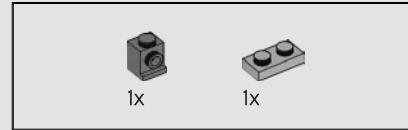
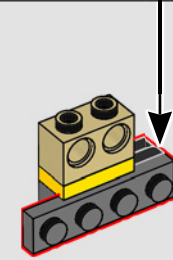
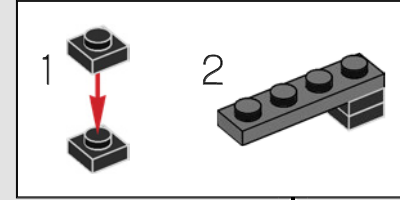

21

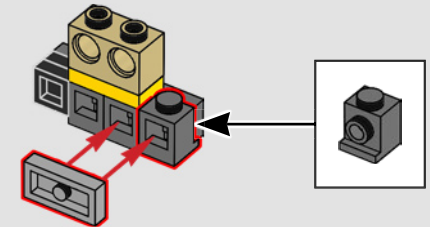
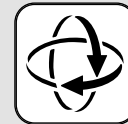

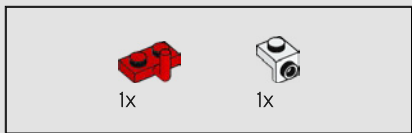

22

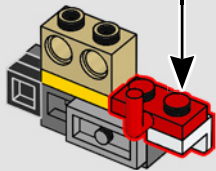
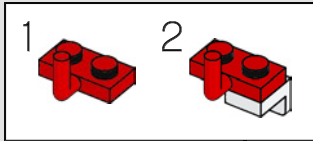

23

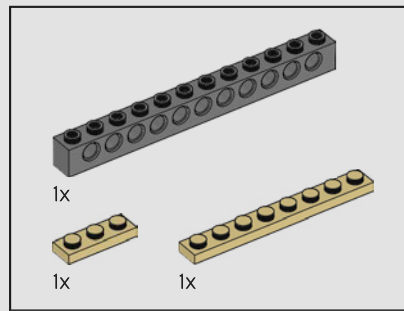
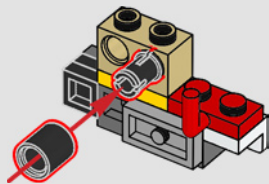

24

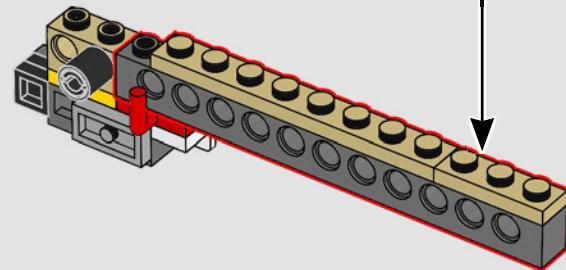
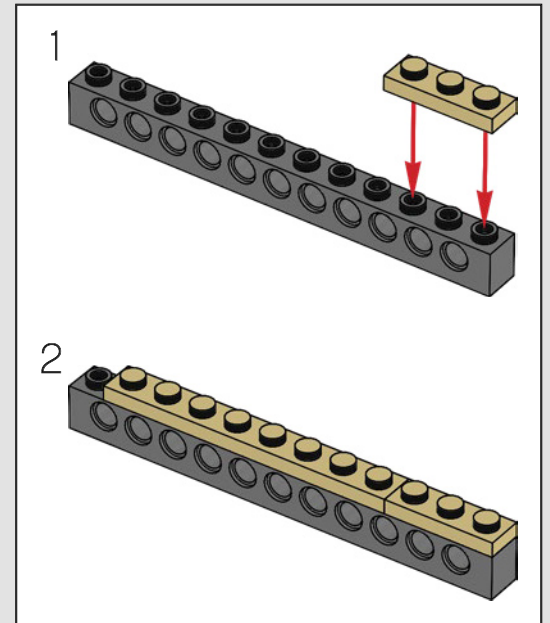

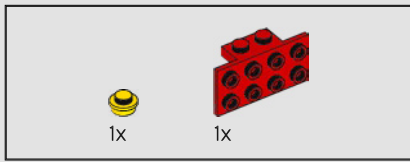

25

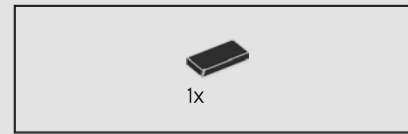
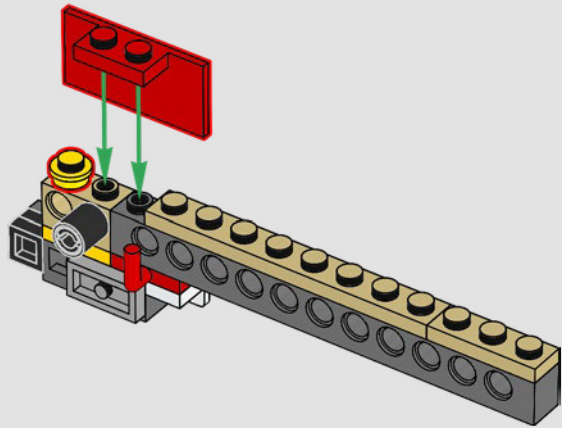

26

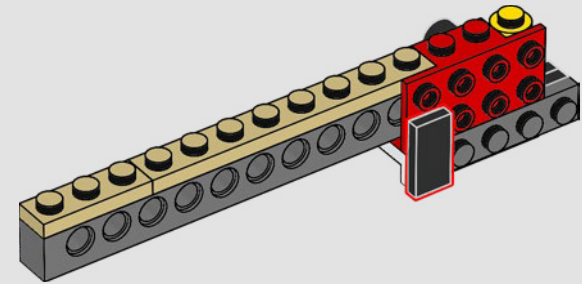
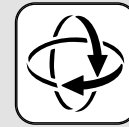

27

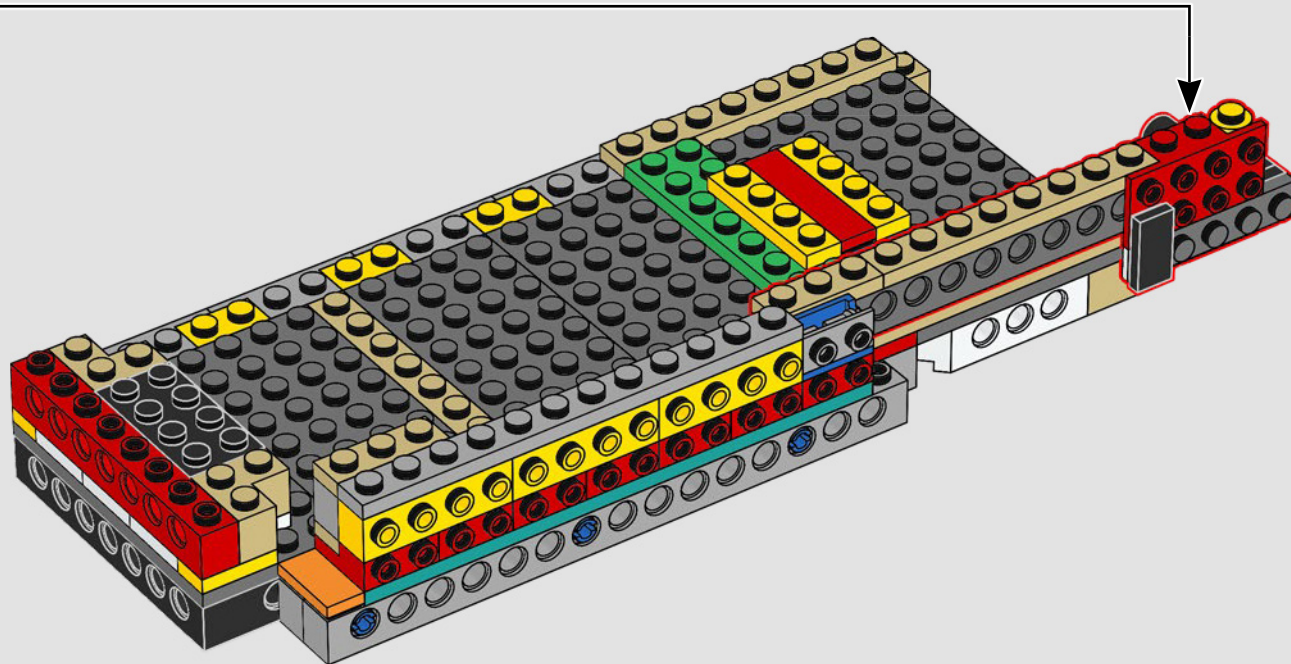

3x

28

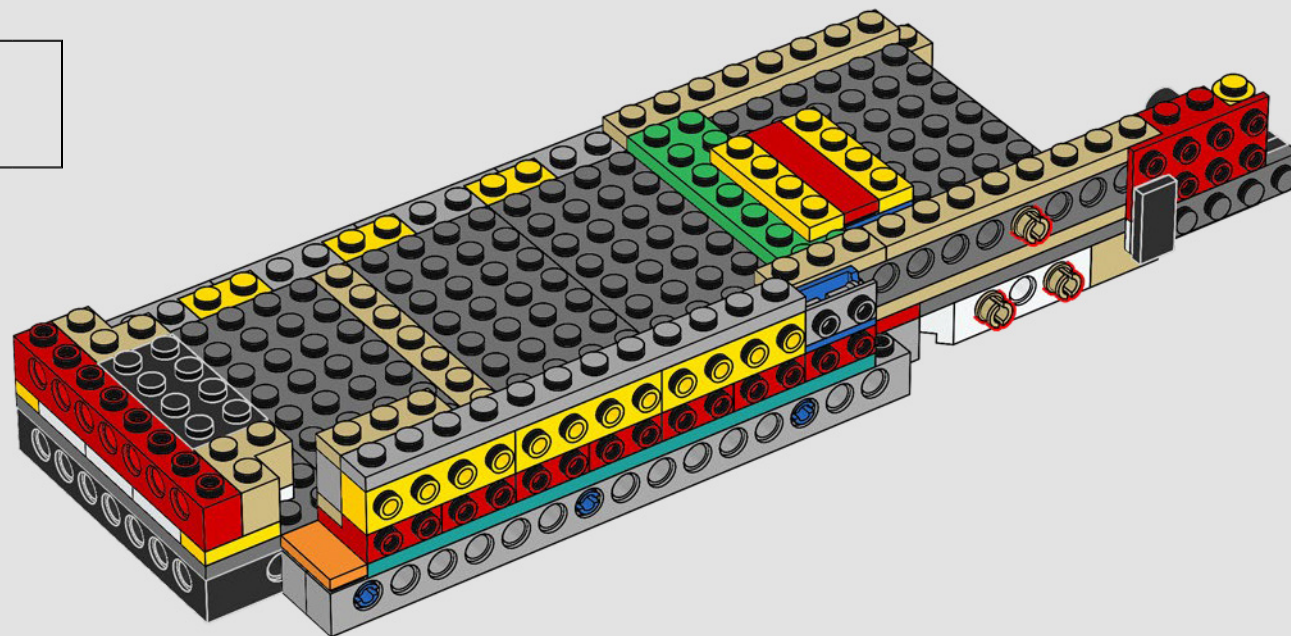

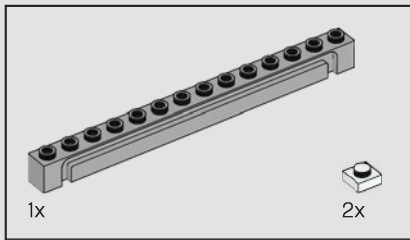

29

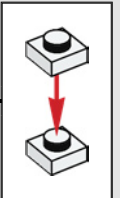
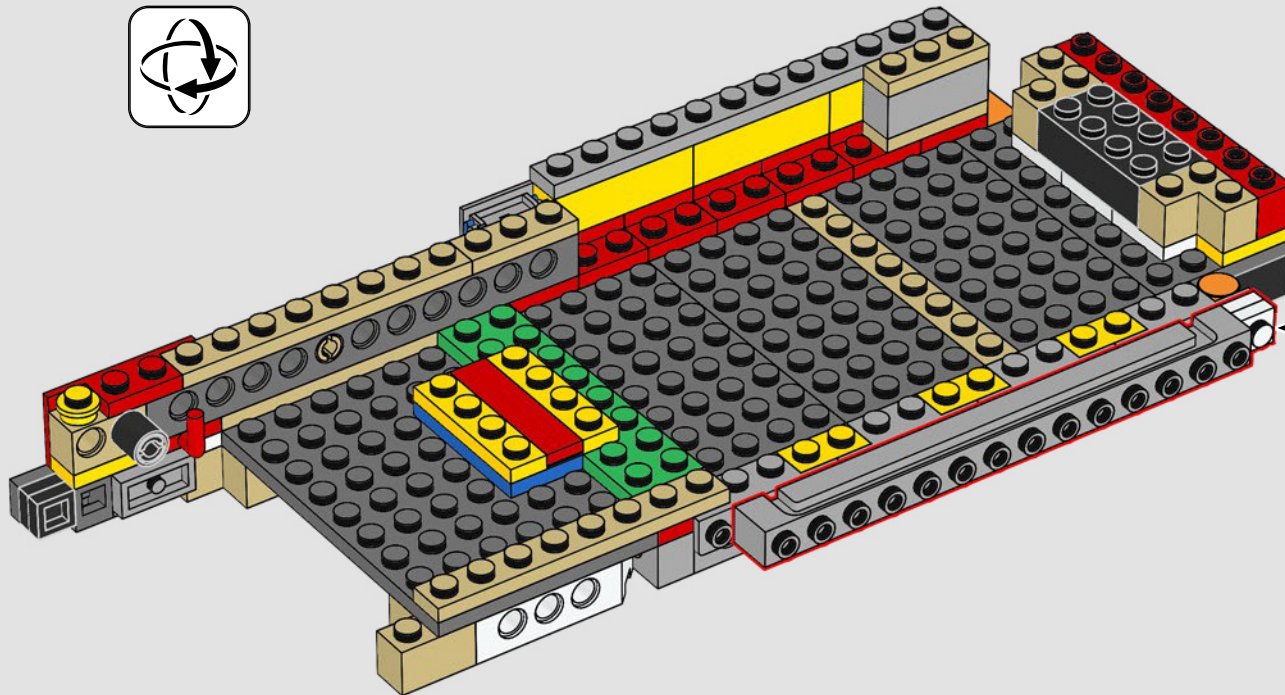

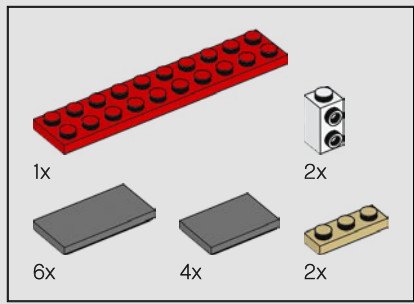

30

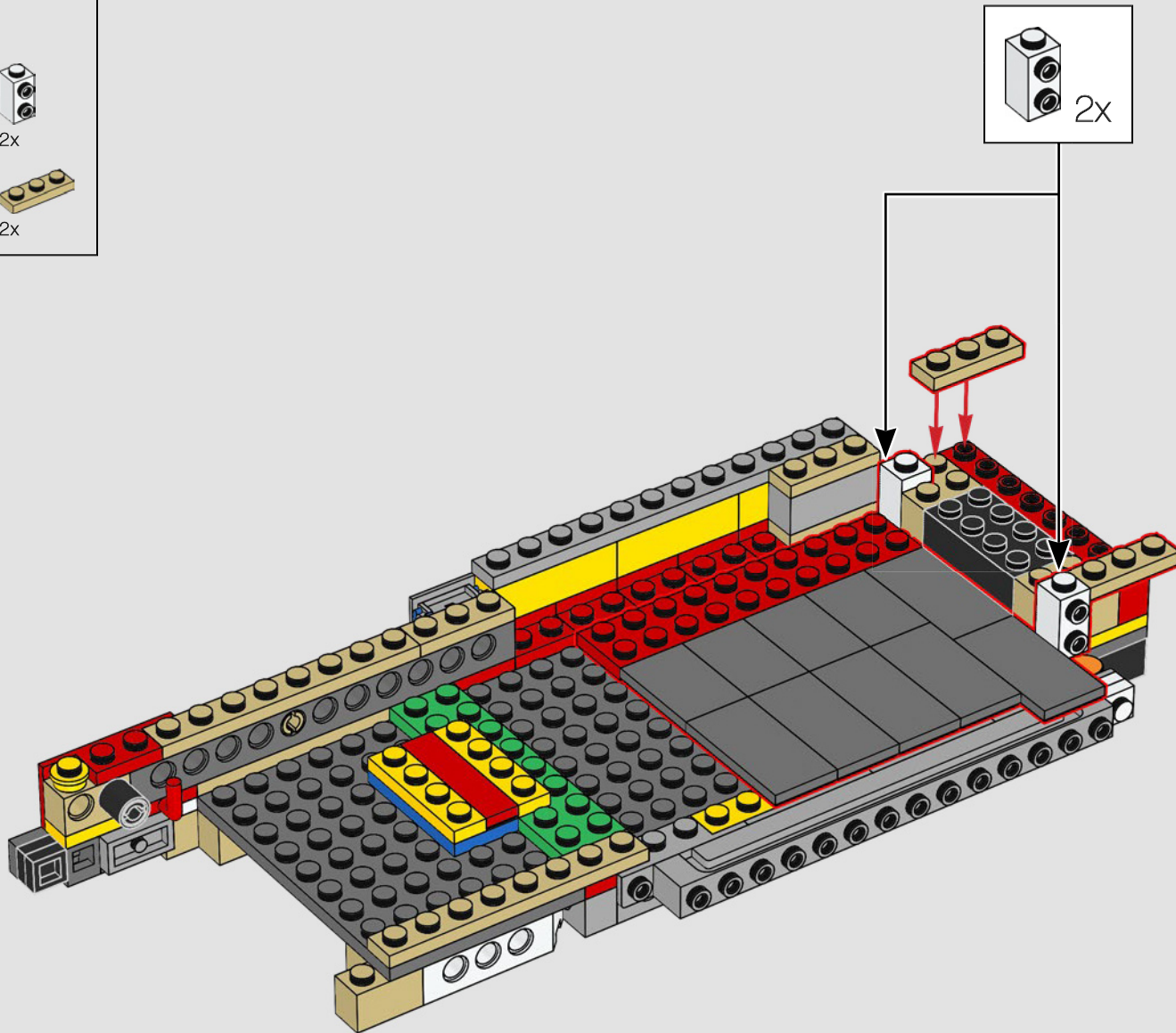

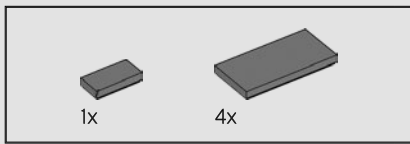

31

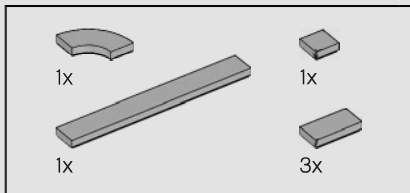
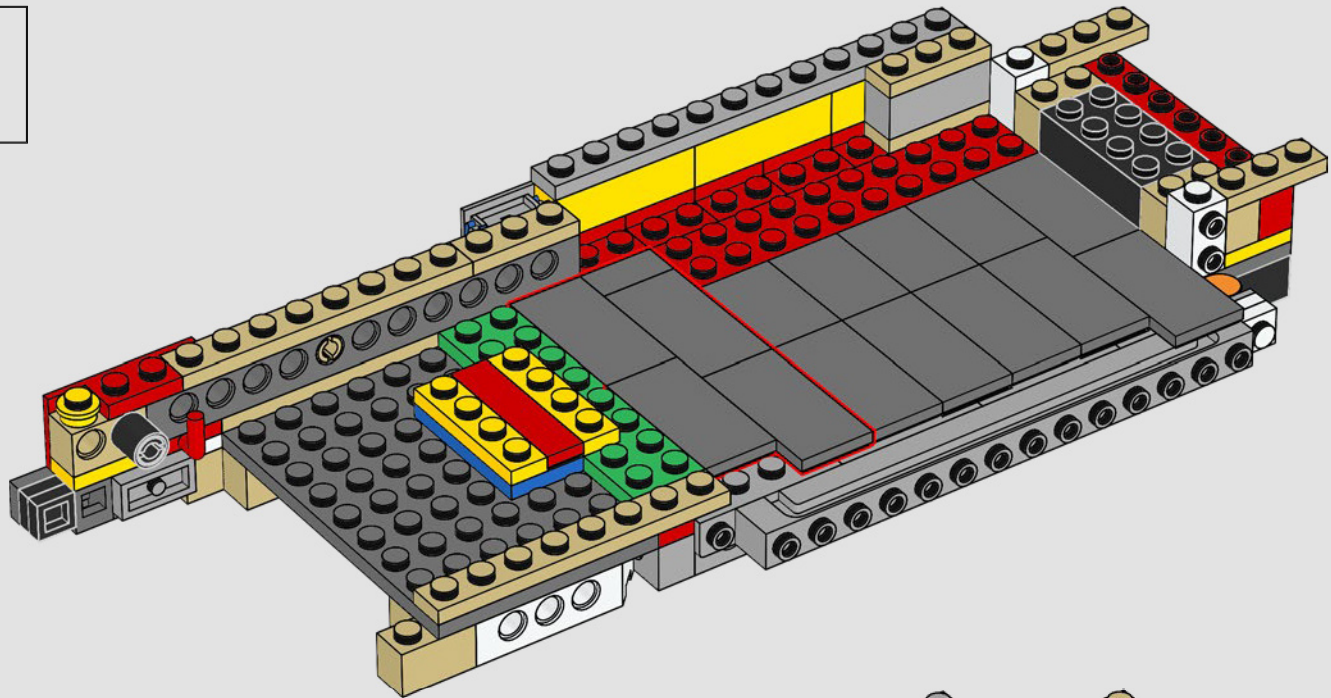

32

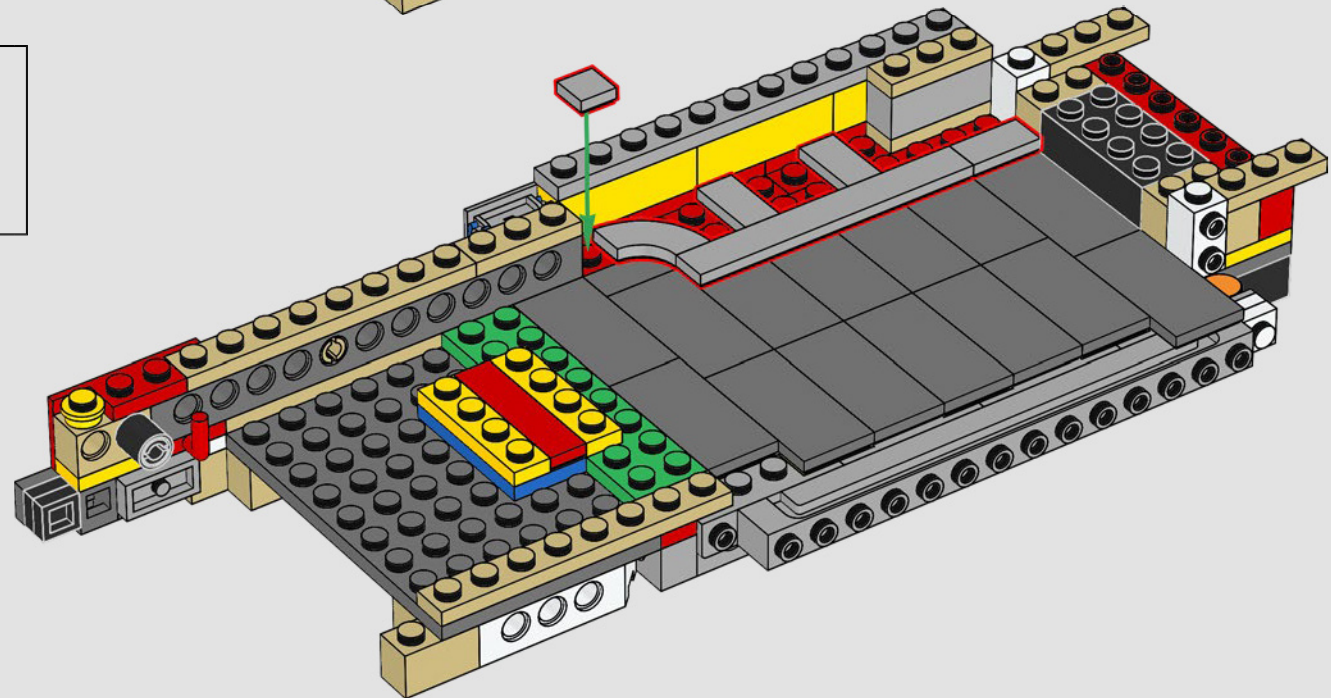

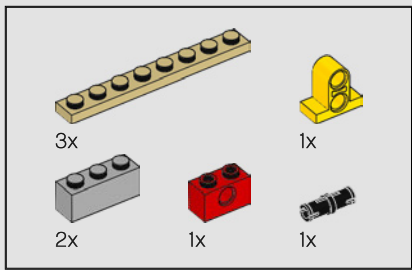

33

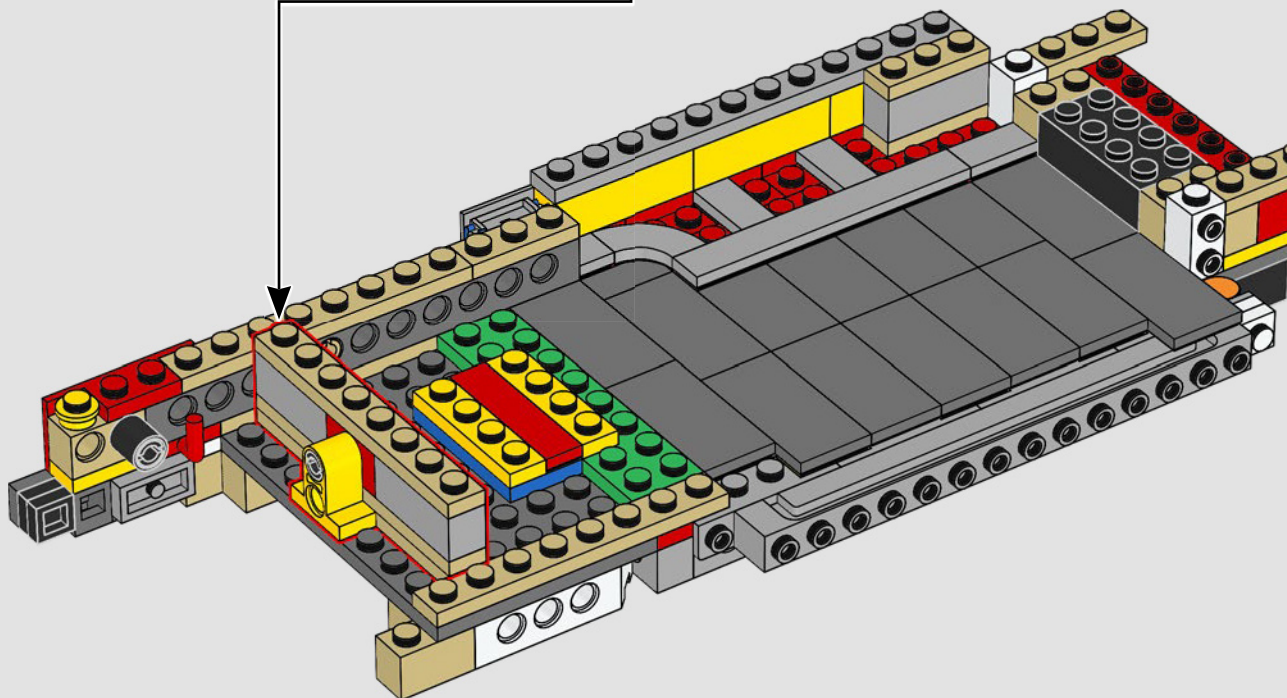
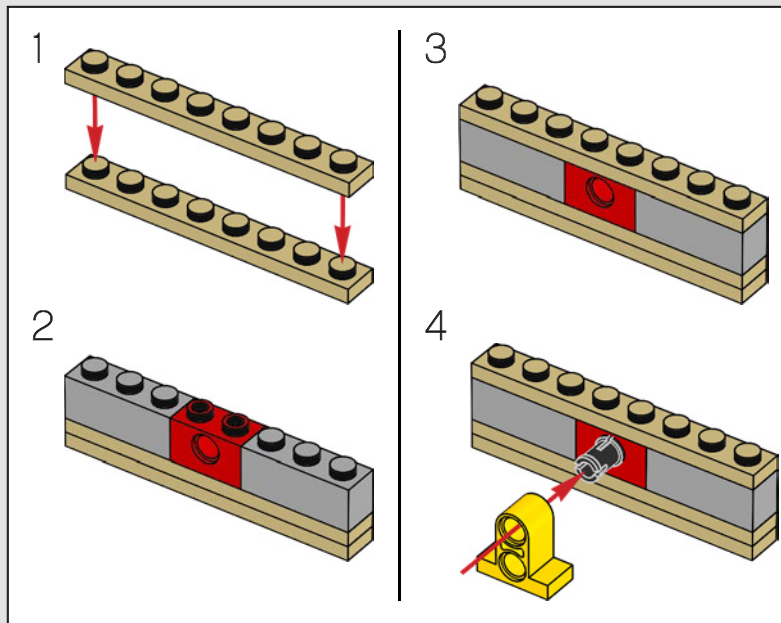

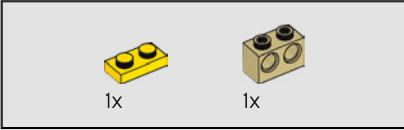
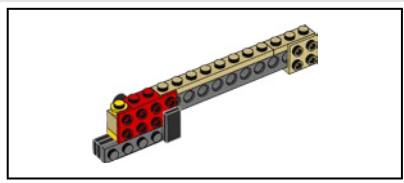

34

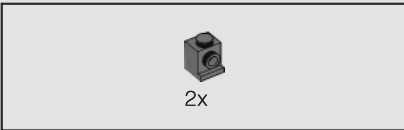
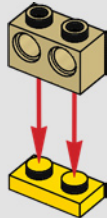

35

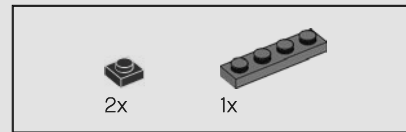
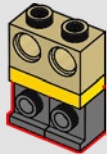

36

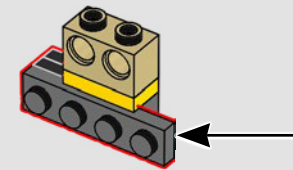
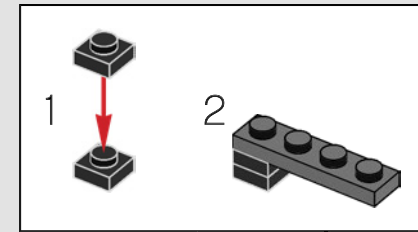

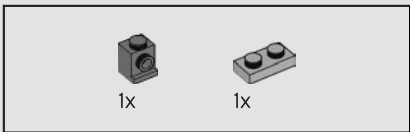

37

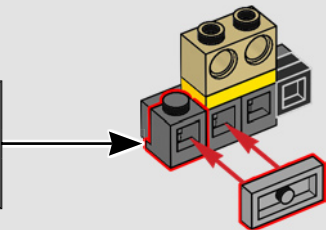
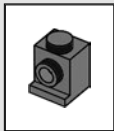

38

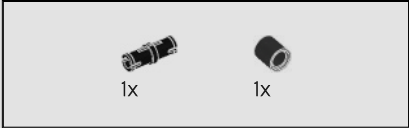
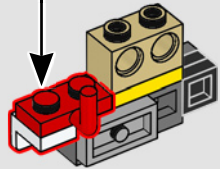
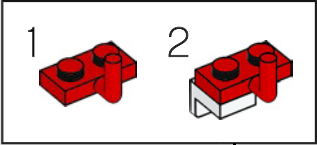

39

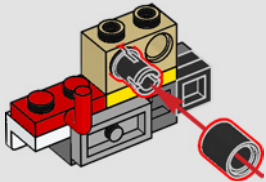

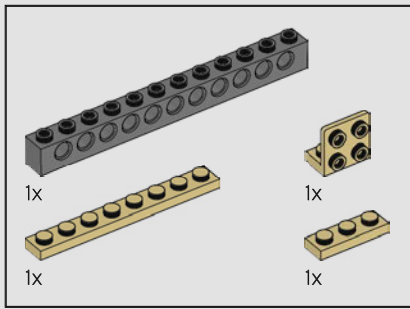

40

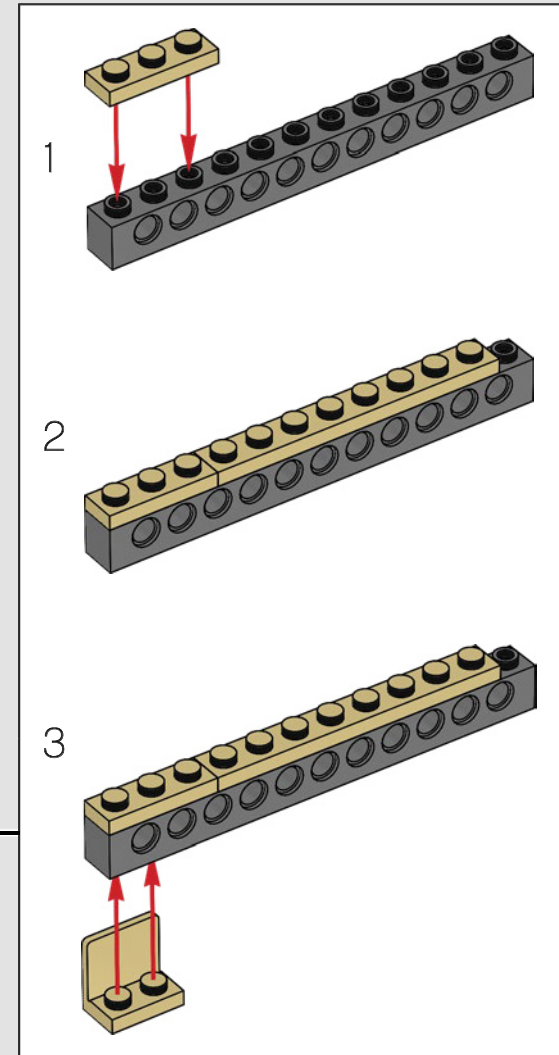
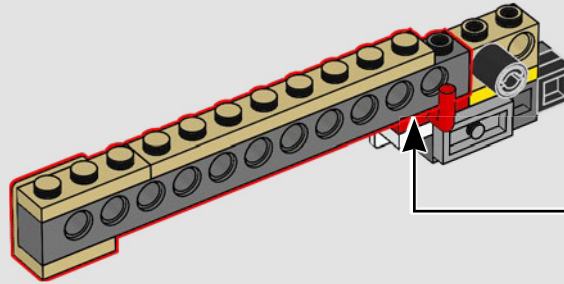

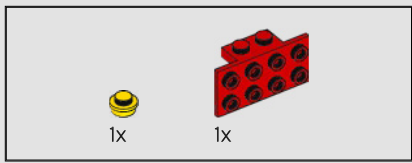

41

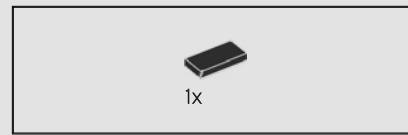
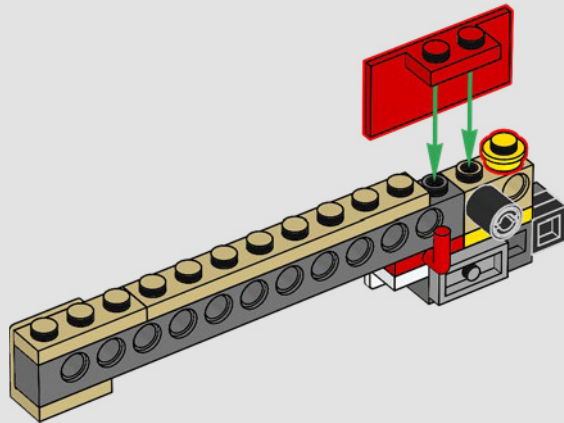

42

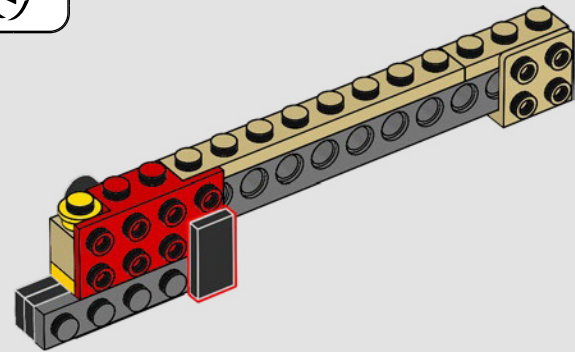
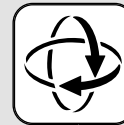

43

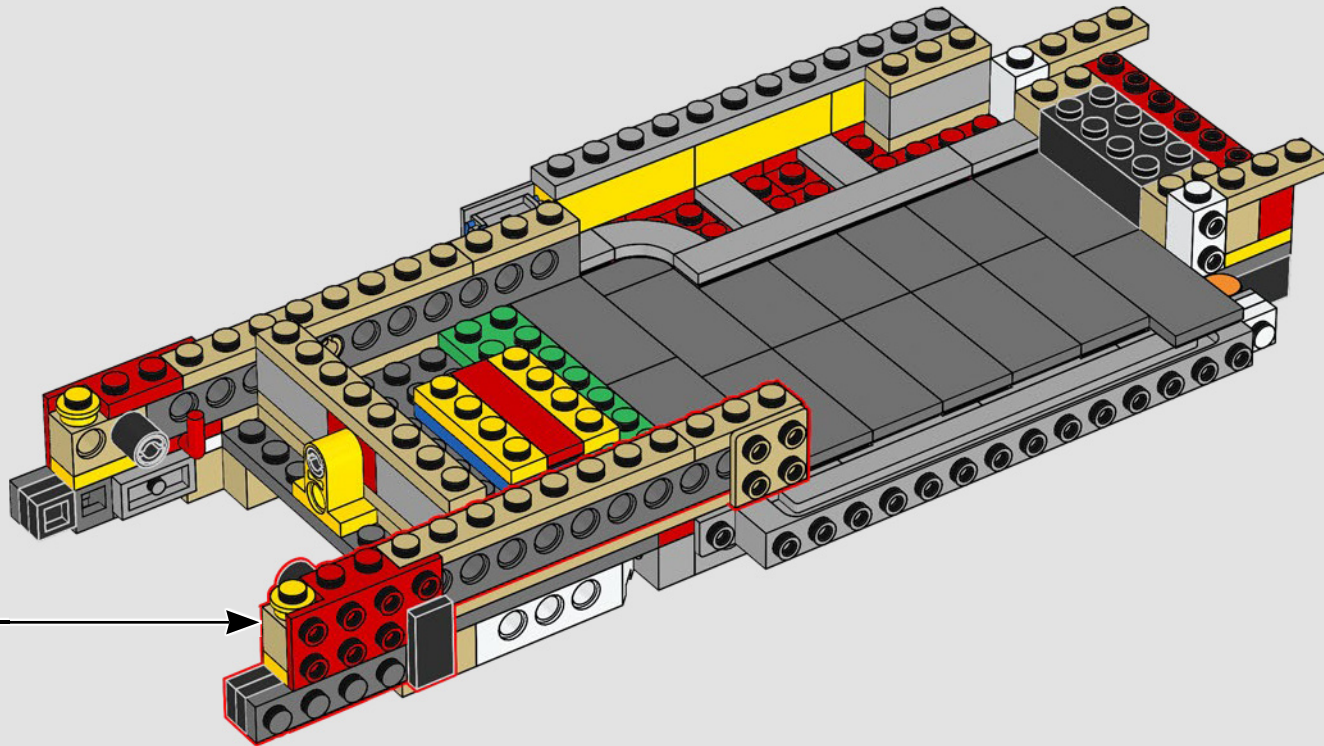



3x

44

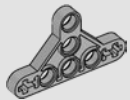
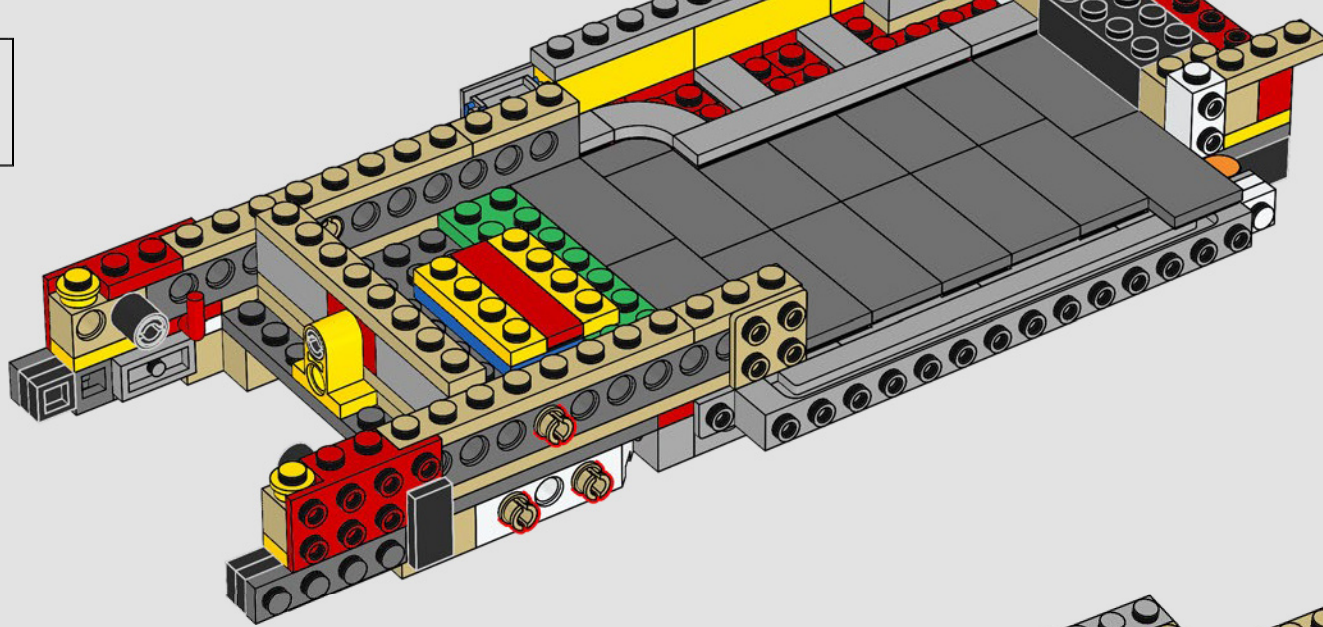

2x



2x



2x



2x

45

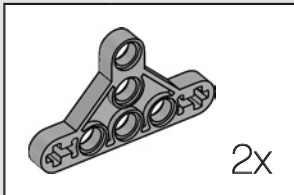

2x

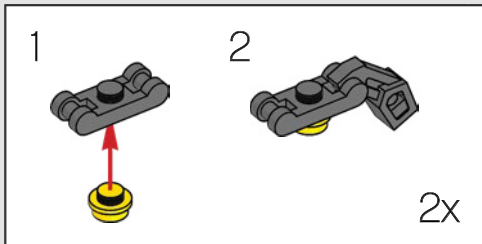

2x

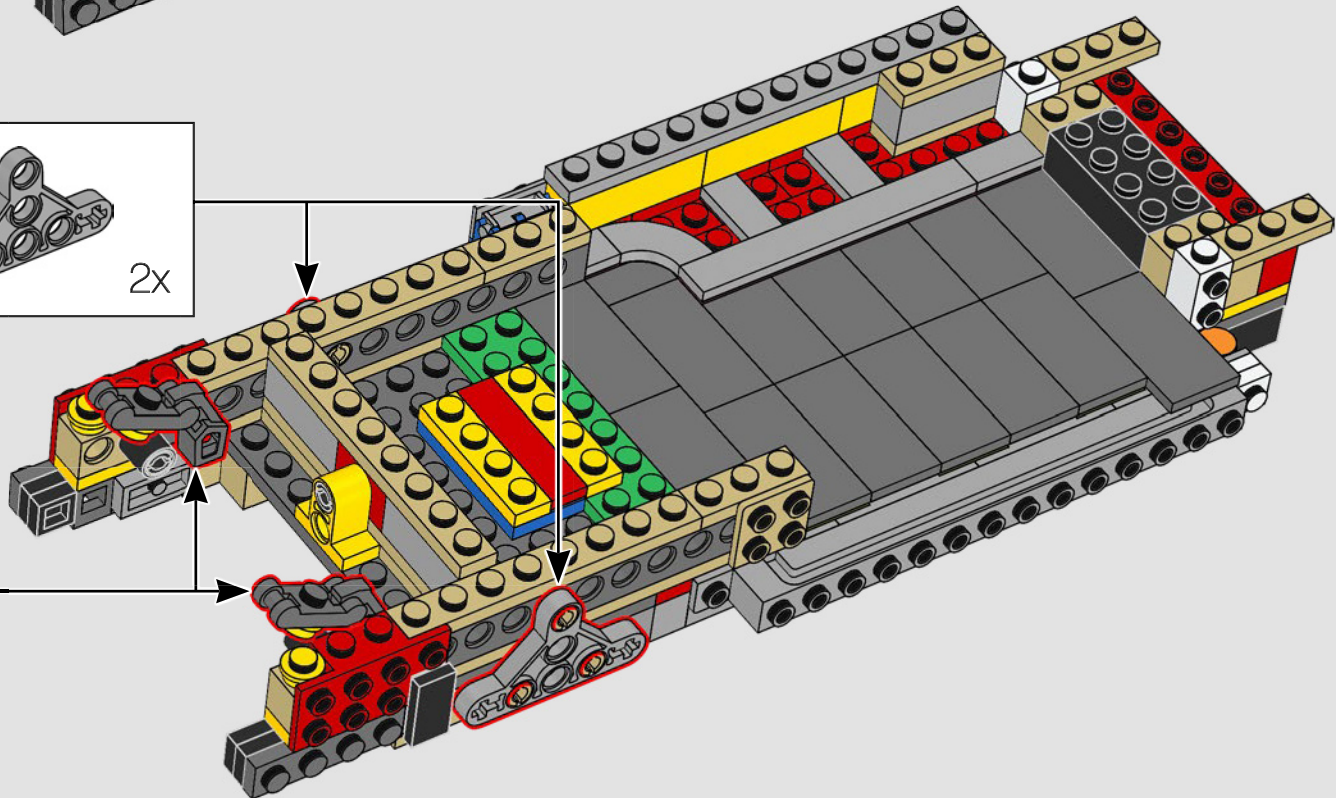

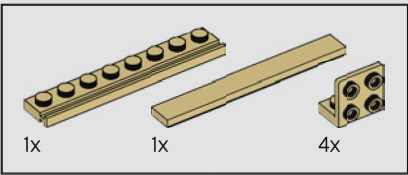
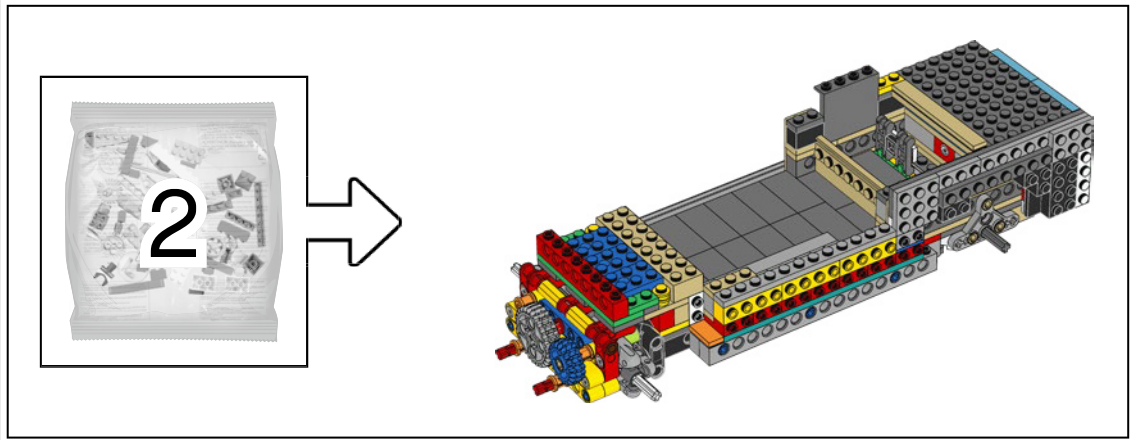

46

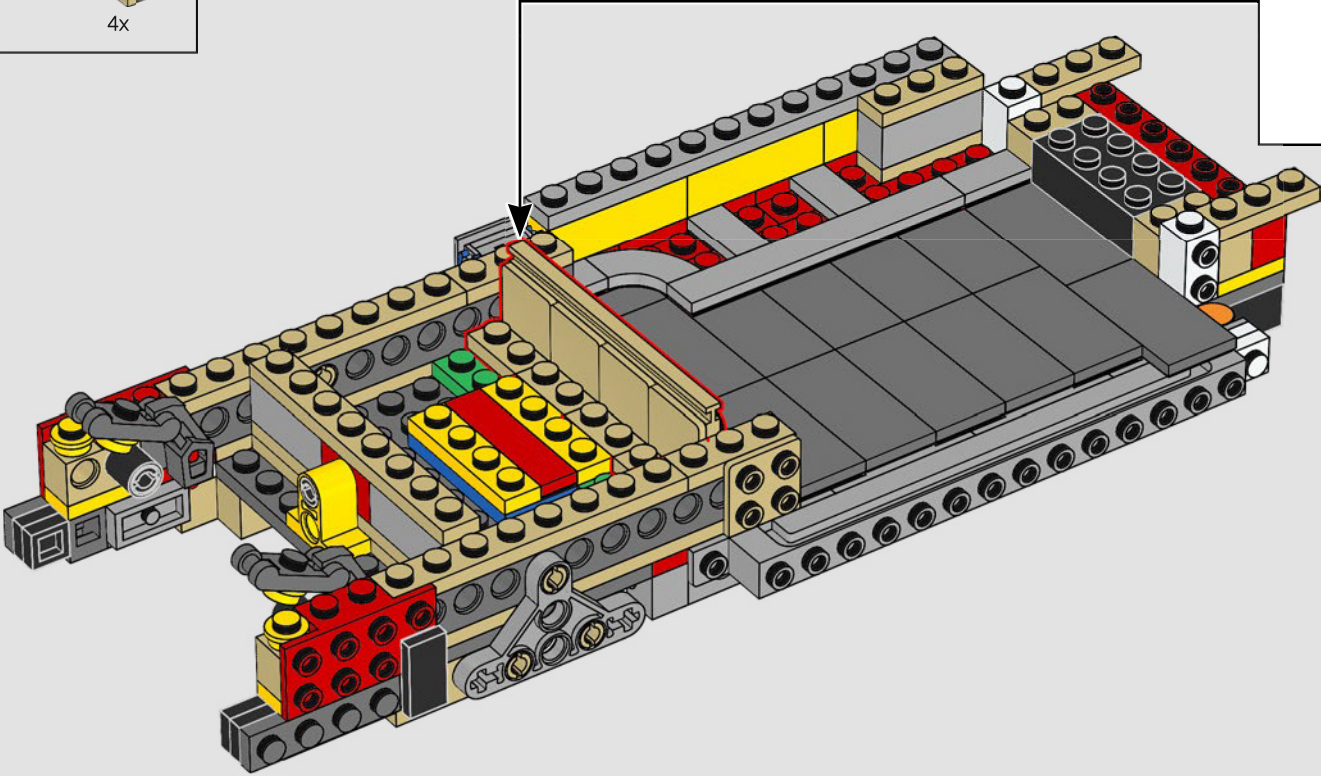
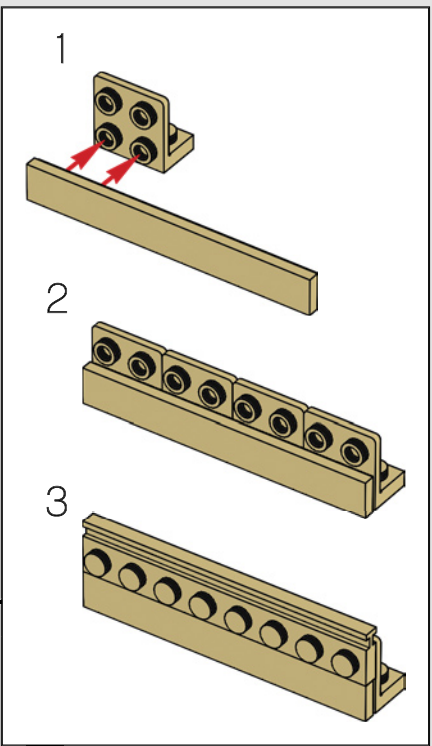

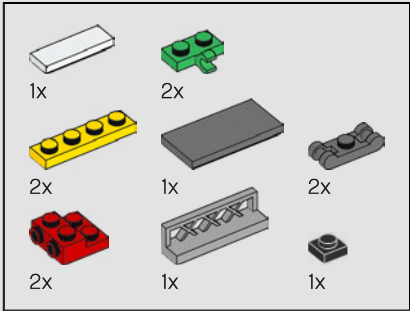
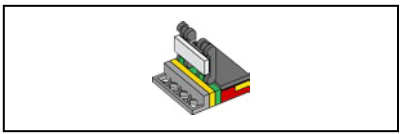

47

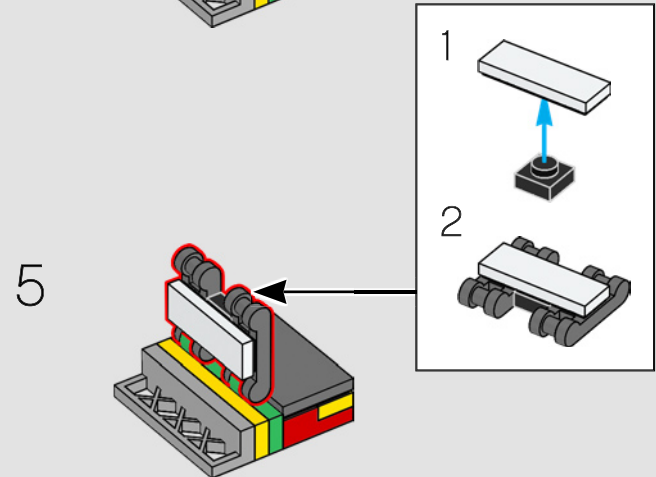
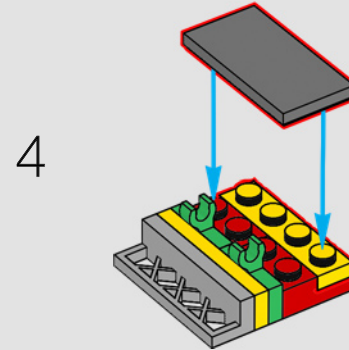
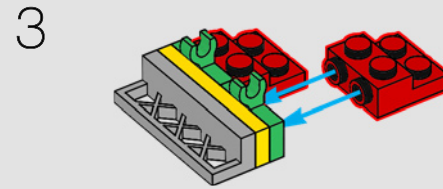
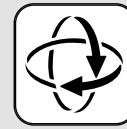
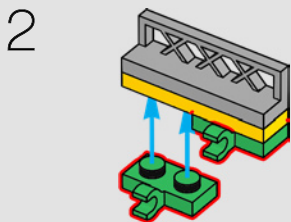
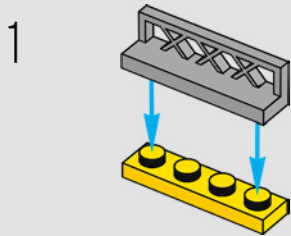

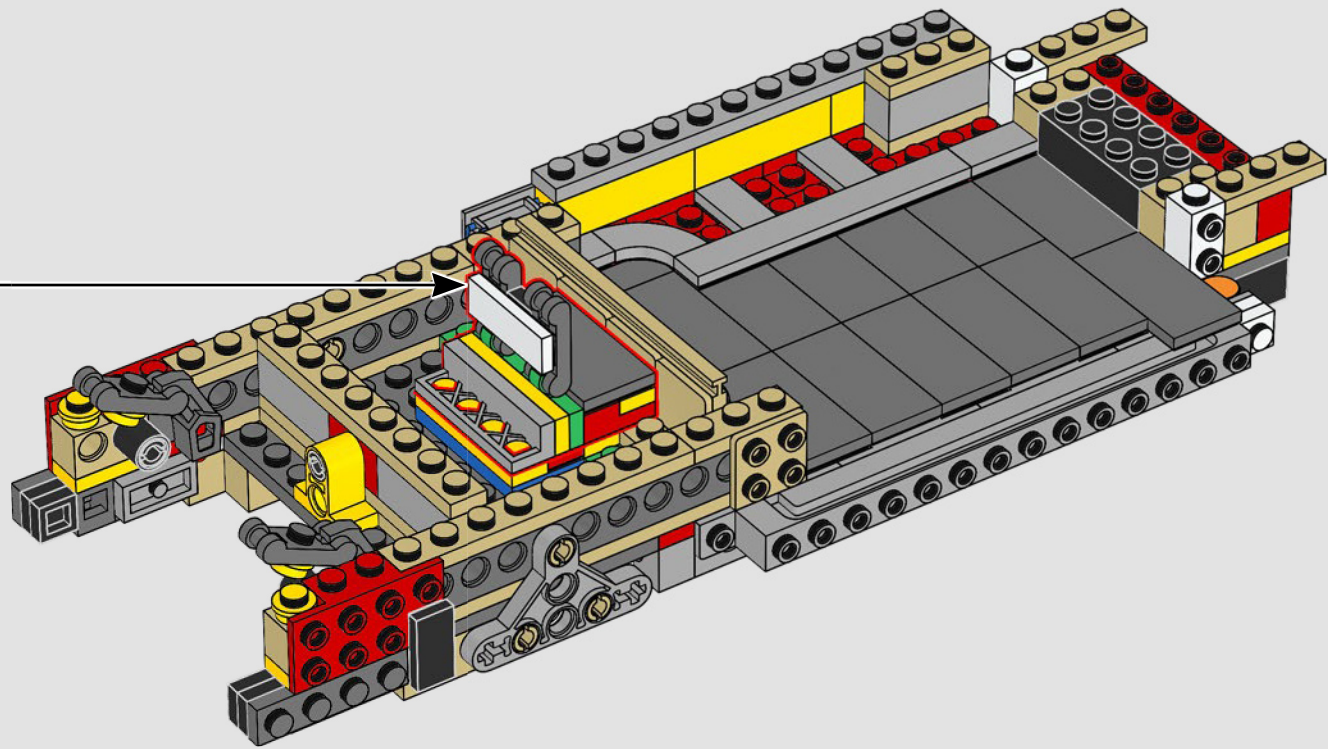

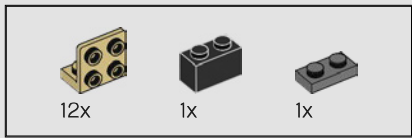

48

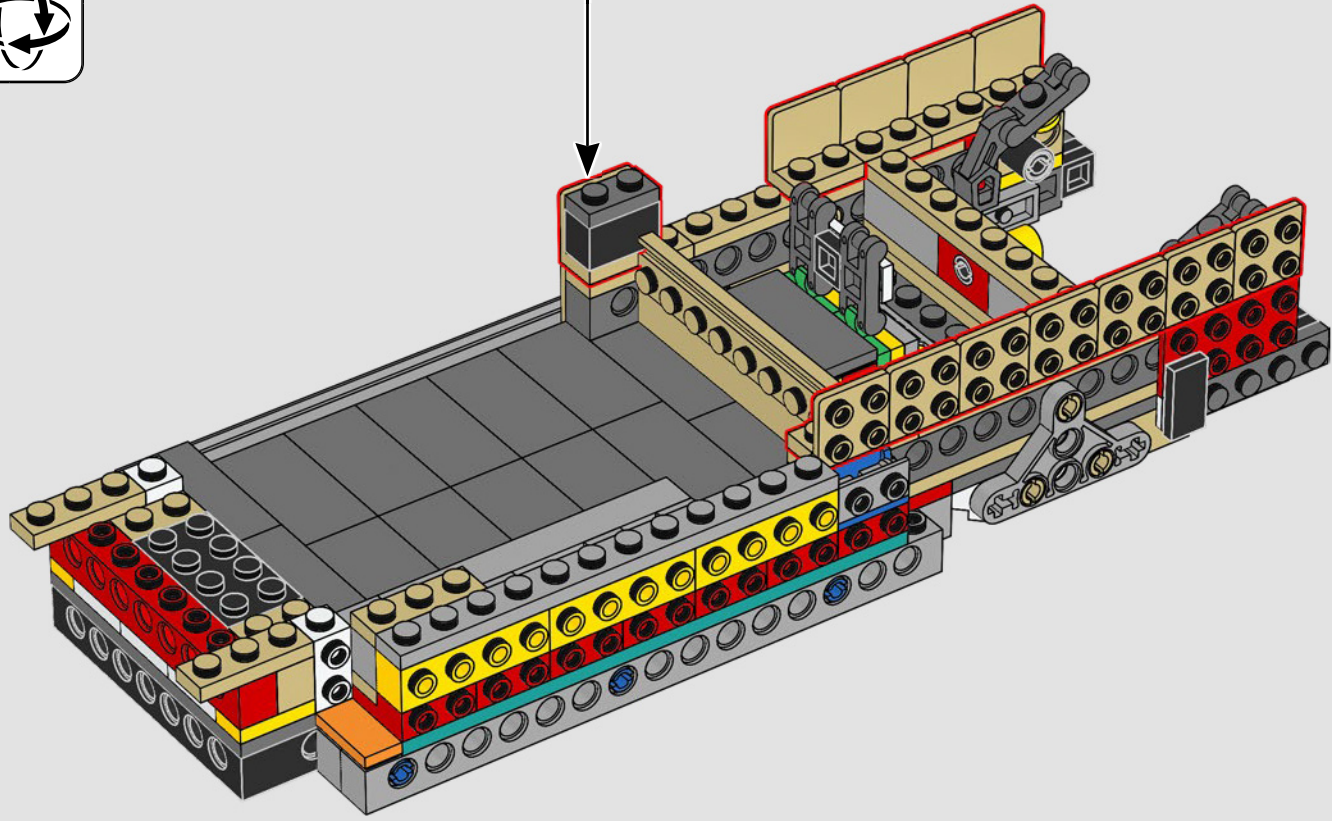
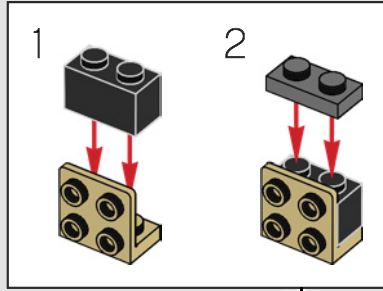

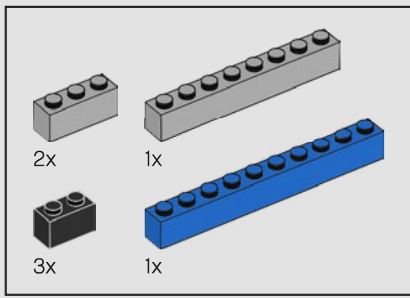

49

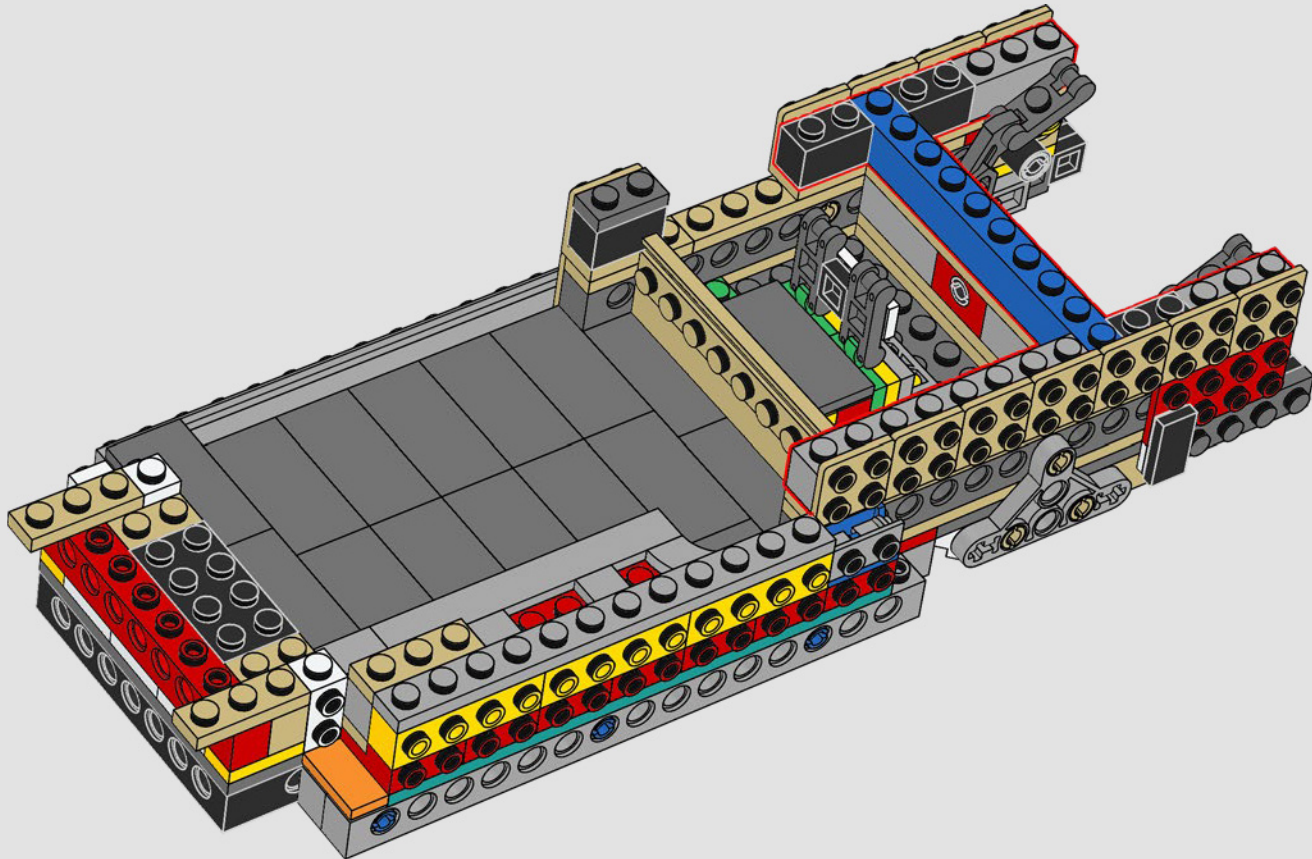

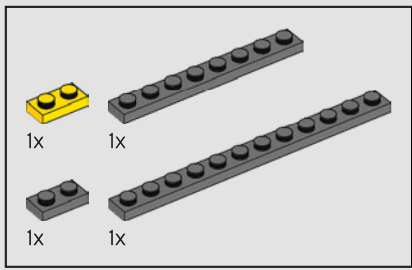

50

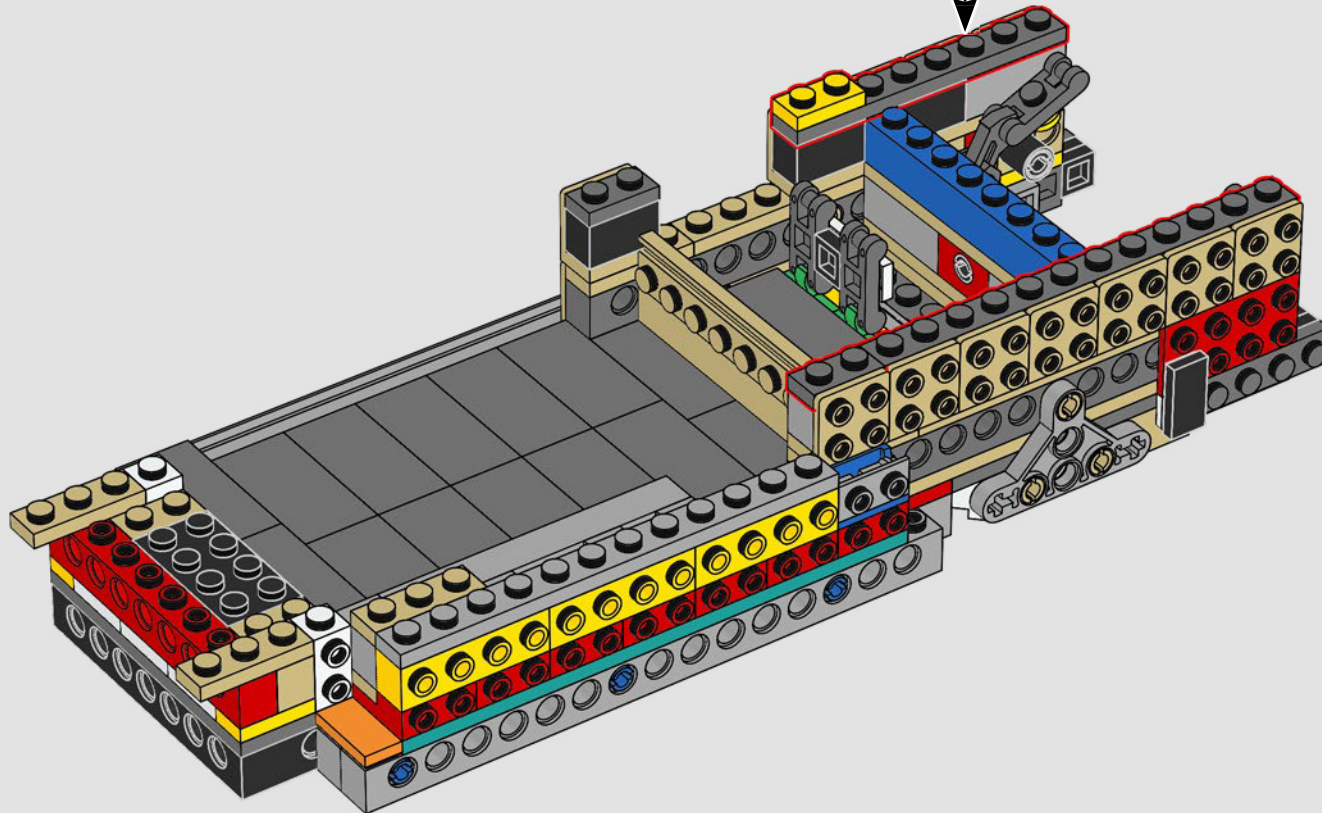
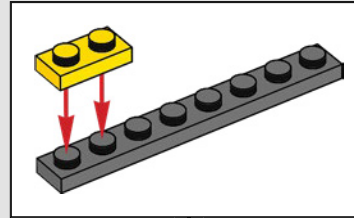

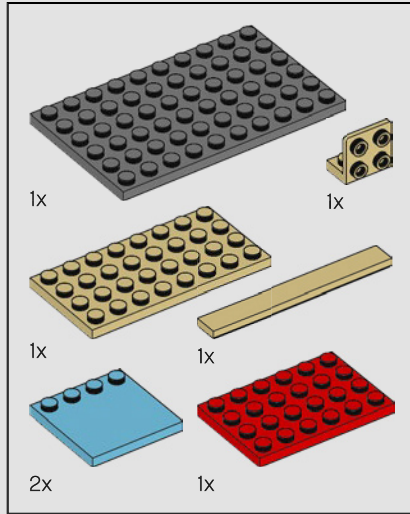
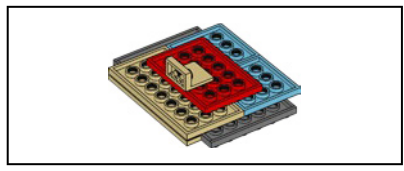

51

1

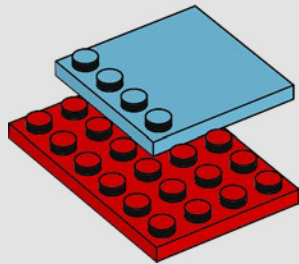

2

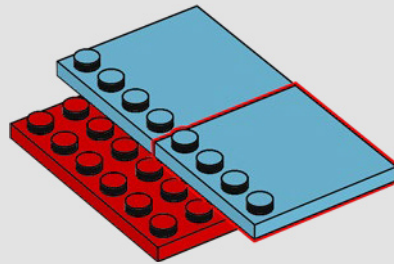

3

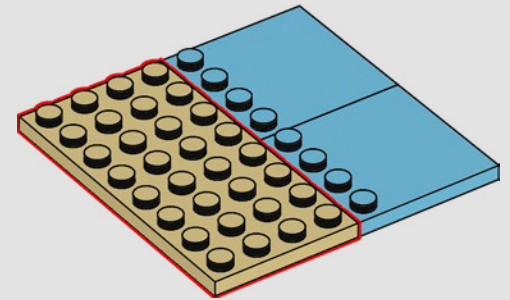

4

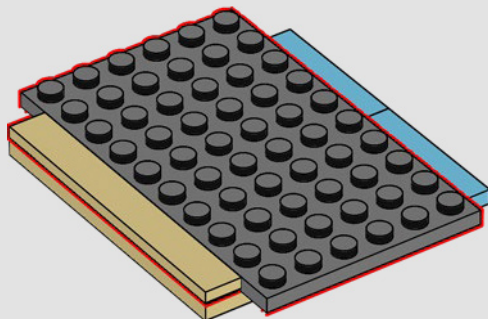

5

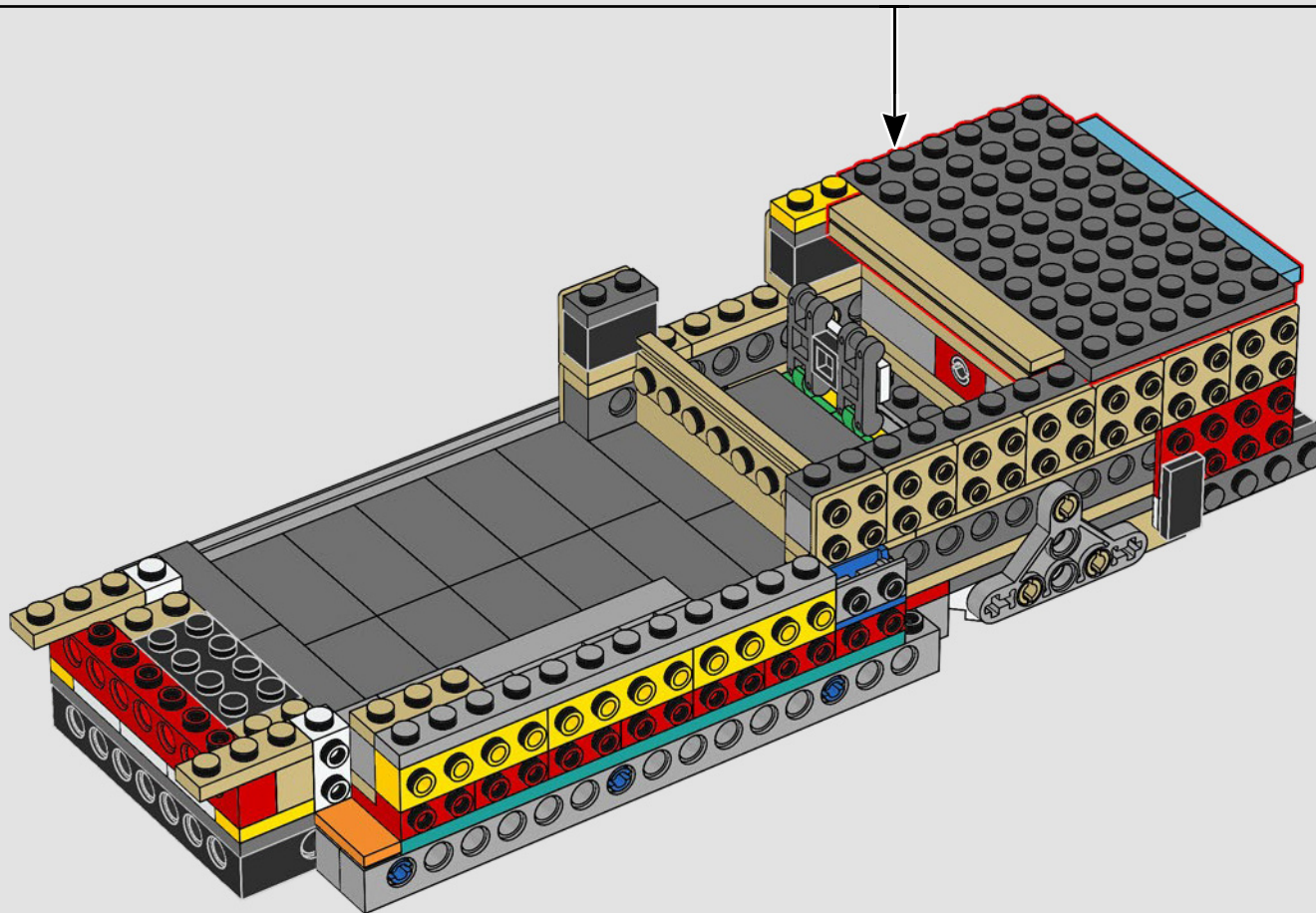
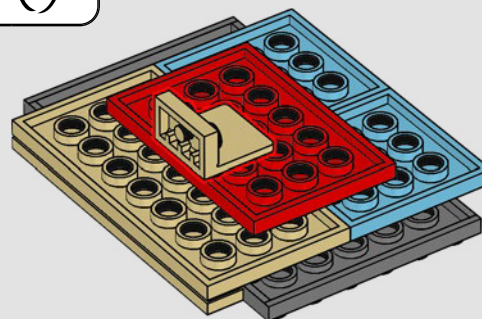

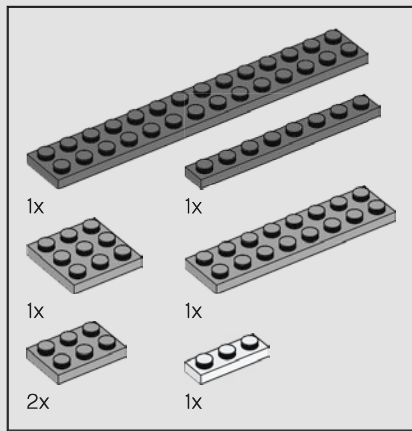

52

1

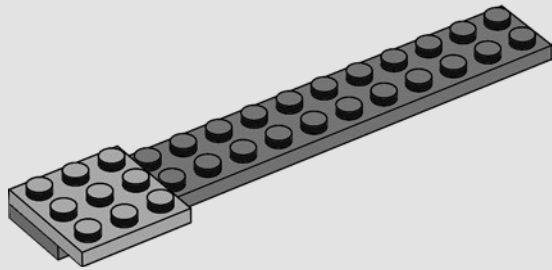

2

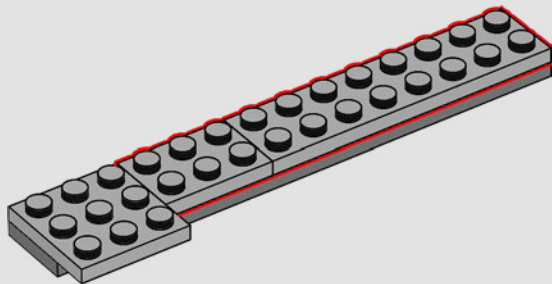

3

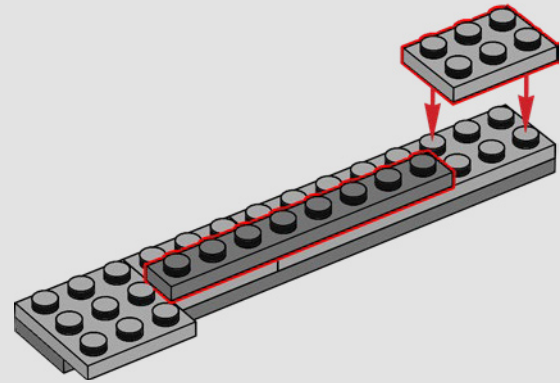

4

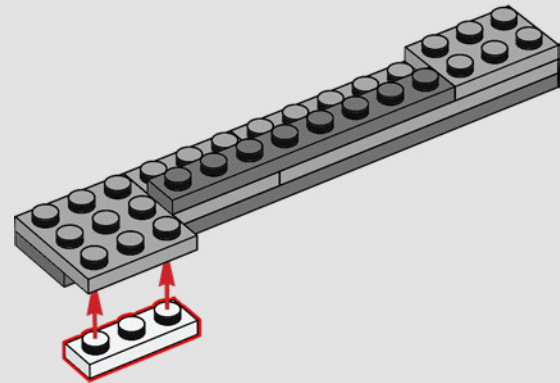

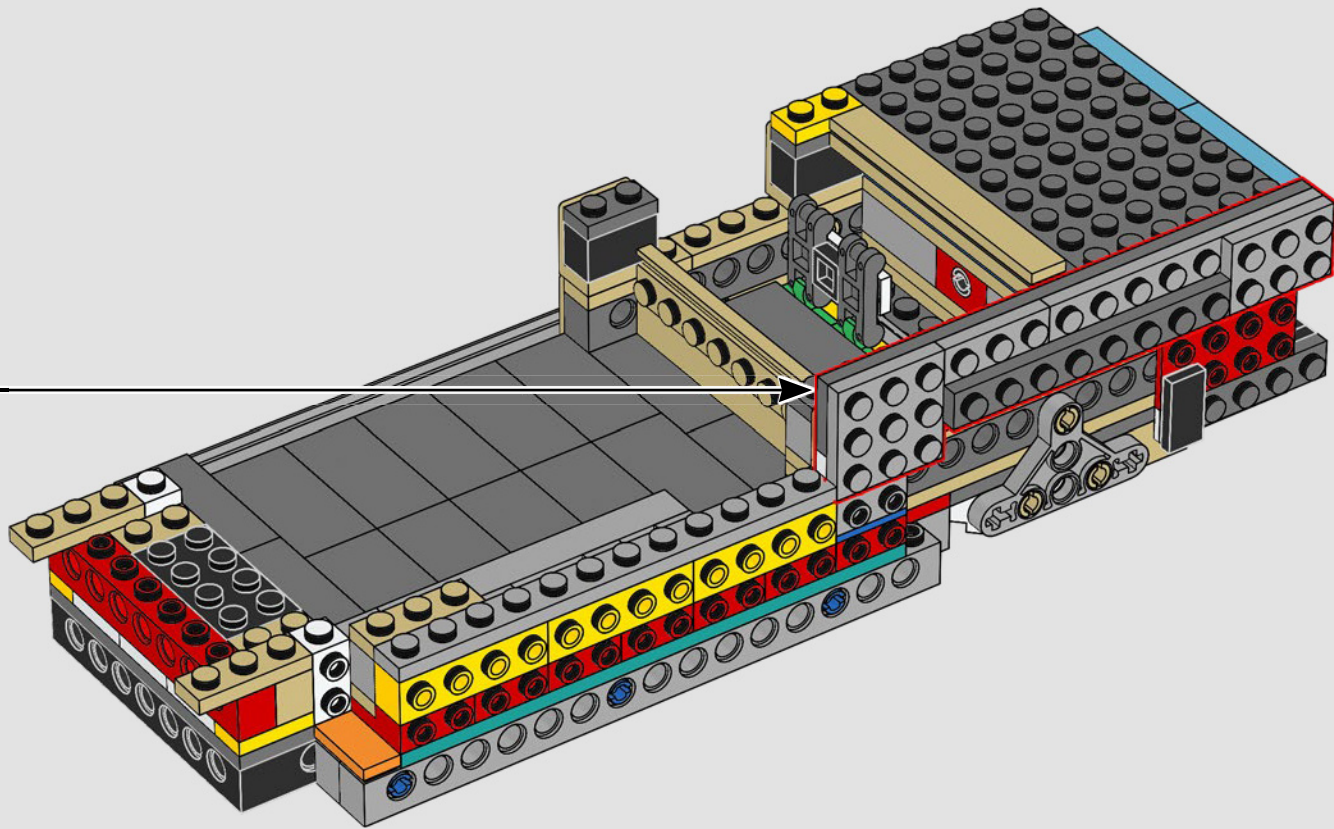

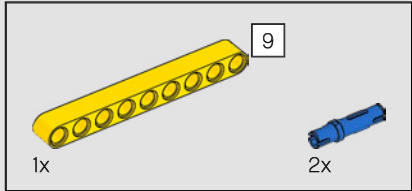
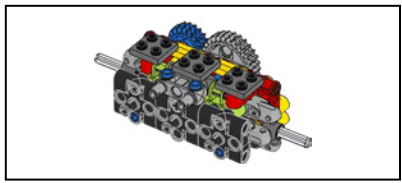

54

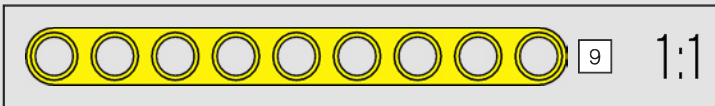
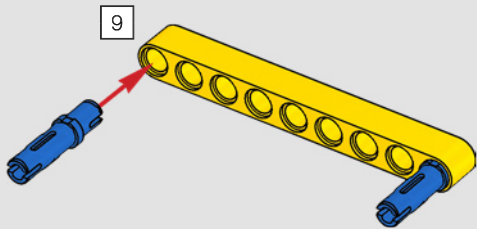

48

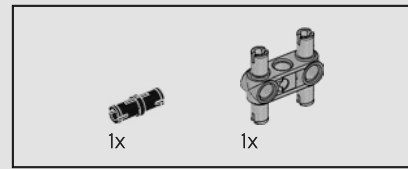

55

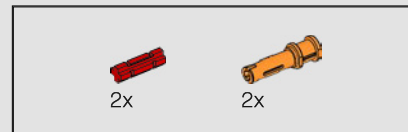
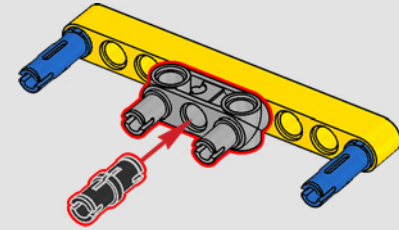

56

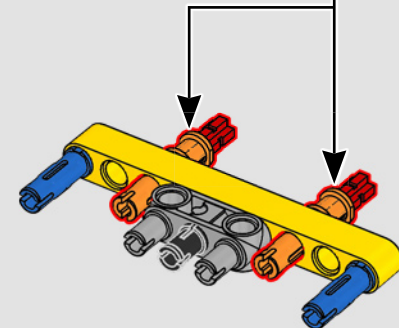
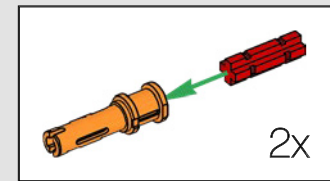

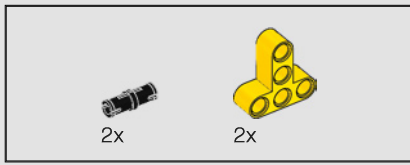

57

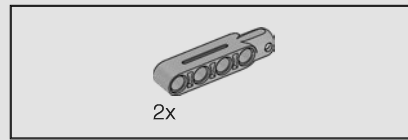
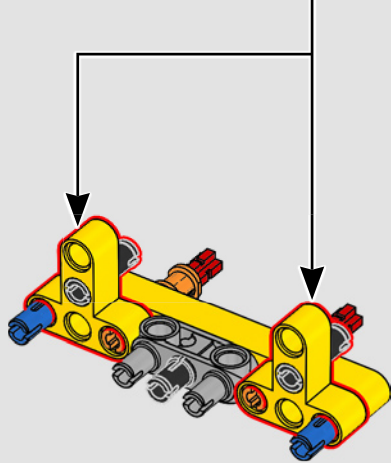
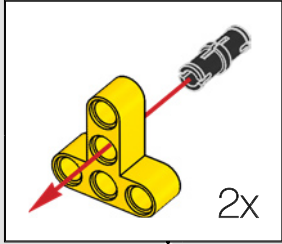

58

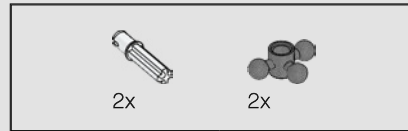
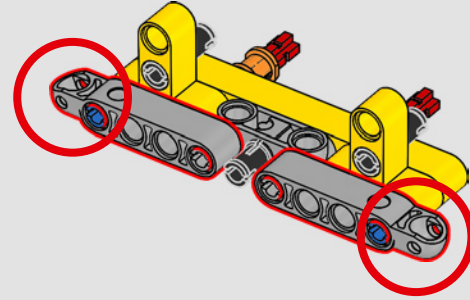

59

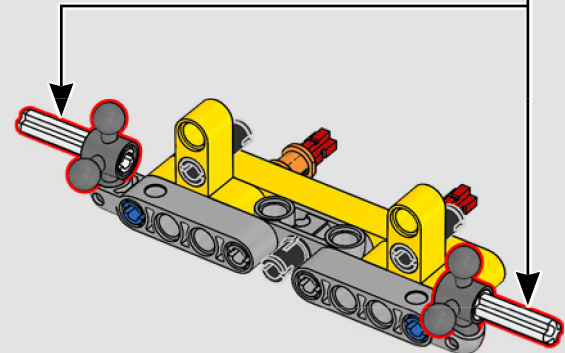
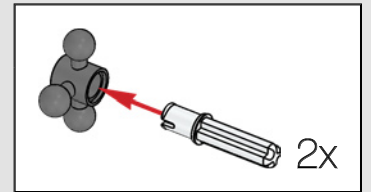

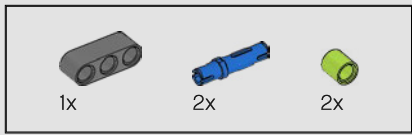

60

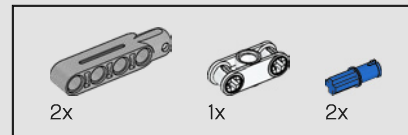
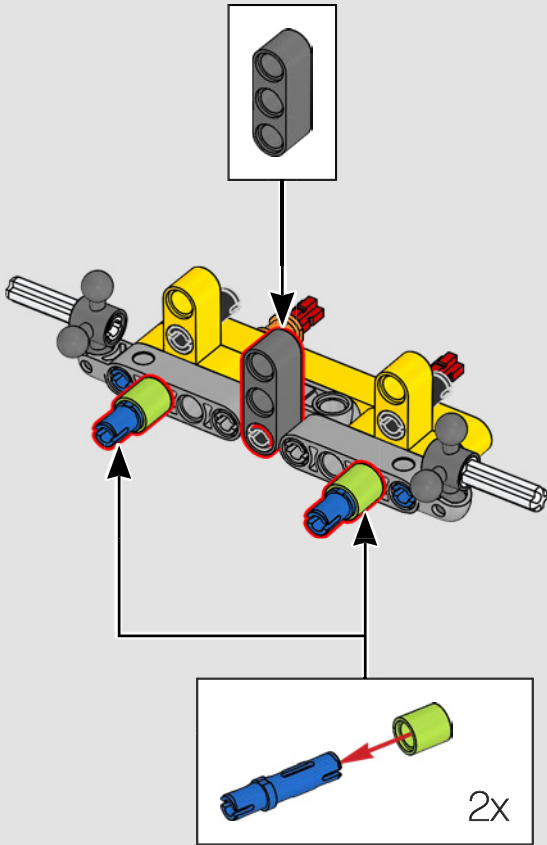

61

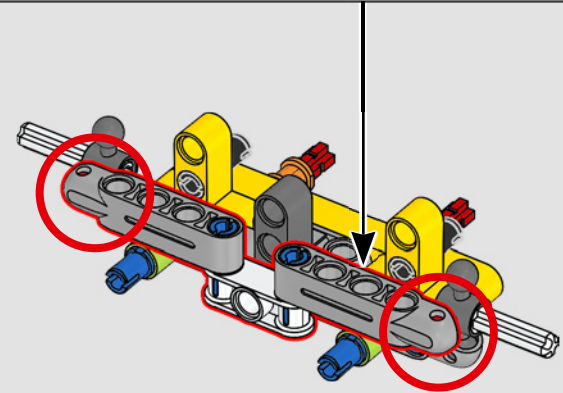
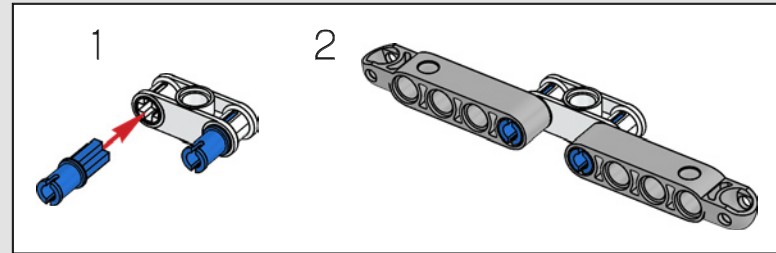

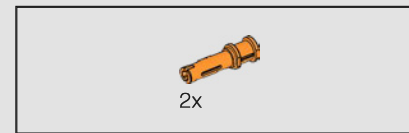
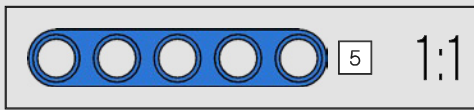
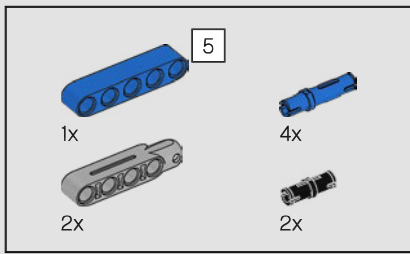

62

63

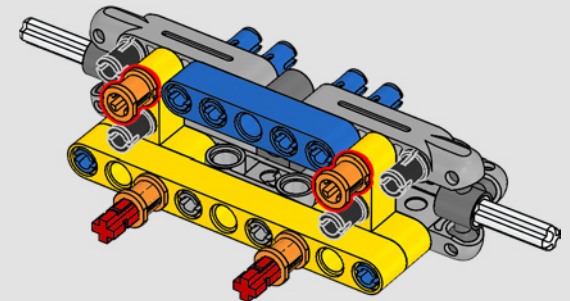
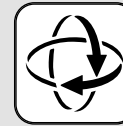
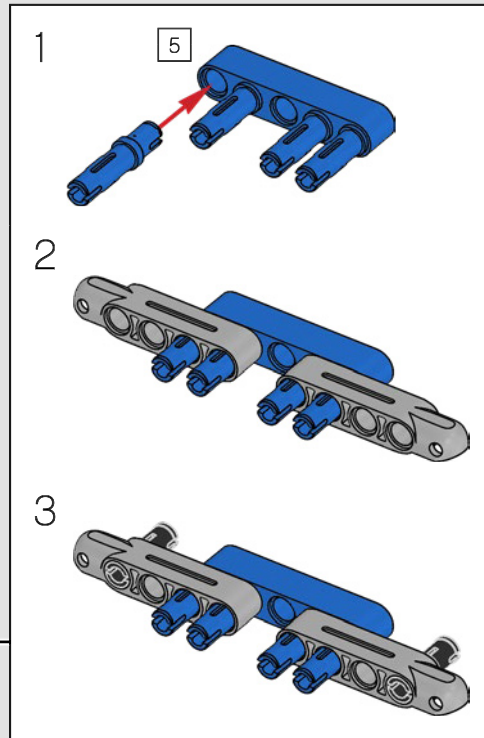
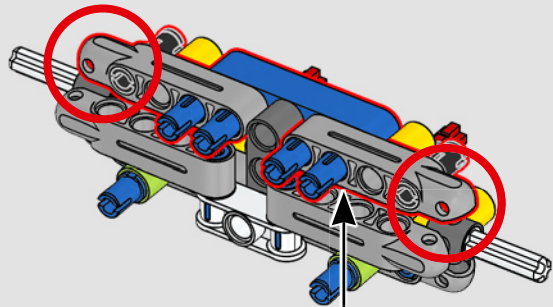

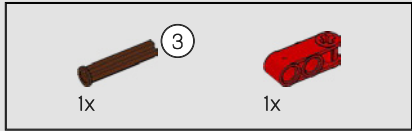
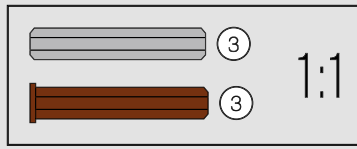
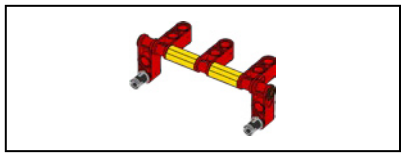

64

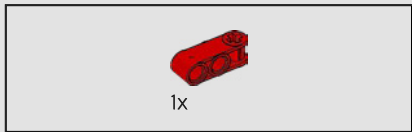
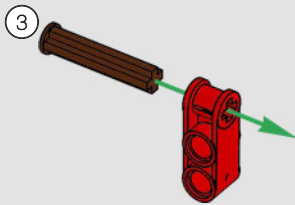

65

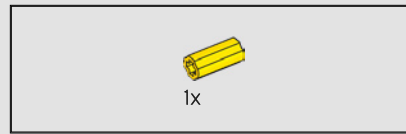
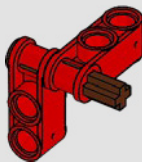

66

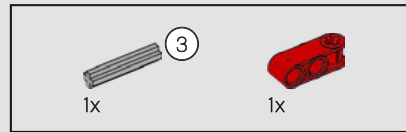
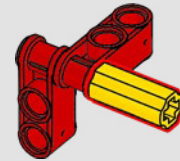

67

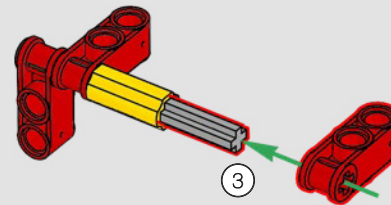

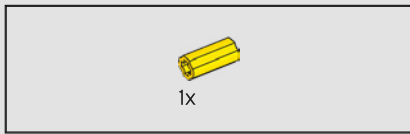

68

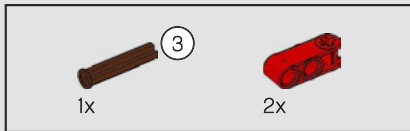
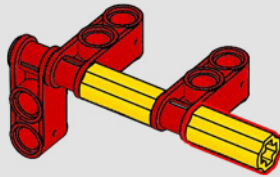

69

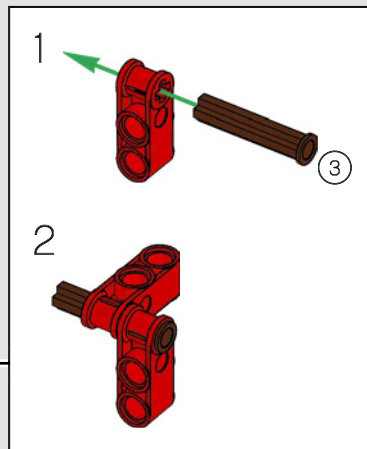
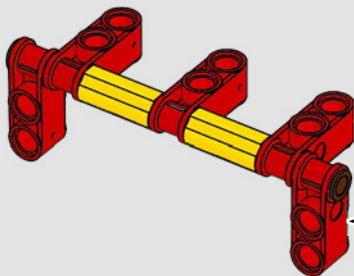

70

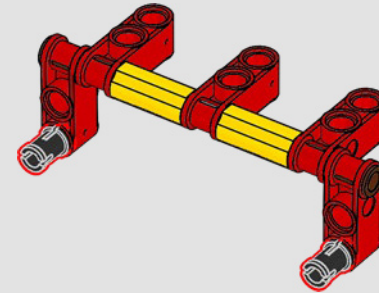

71

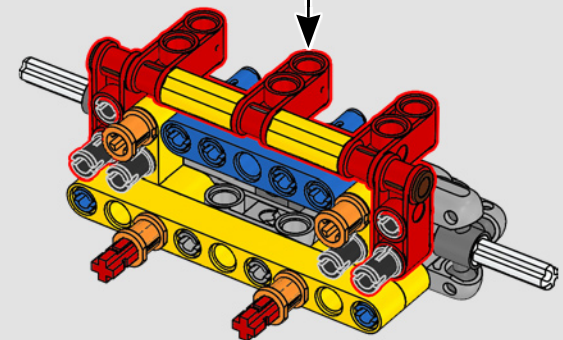

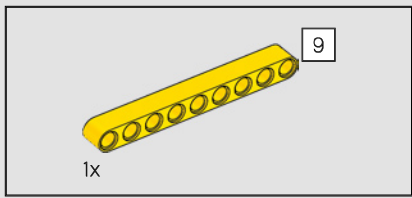

72

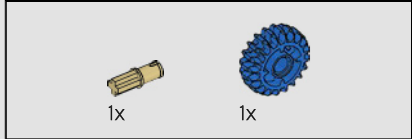
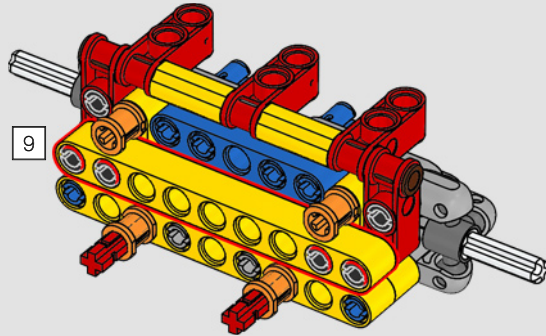

73

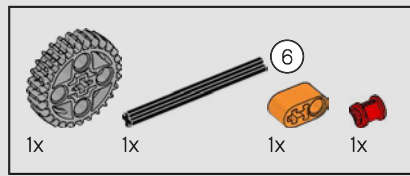
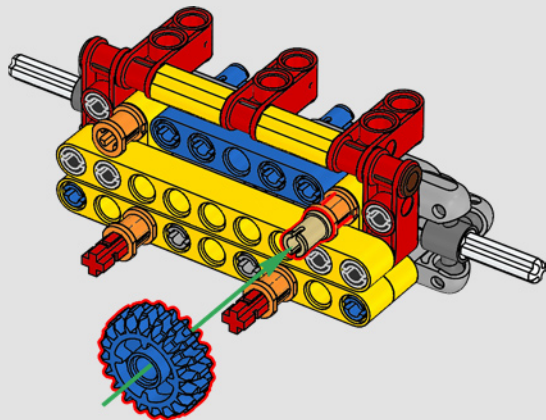

74

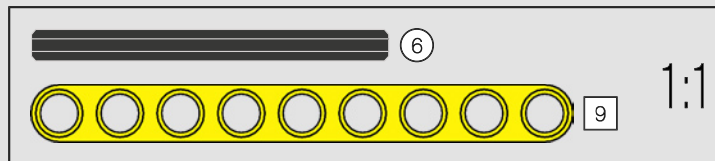
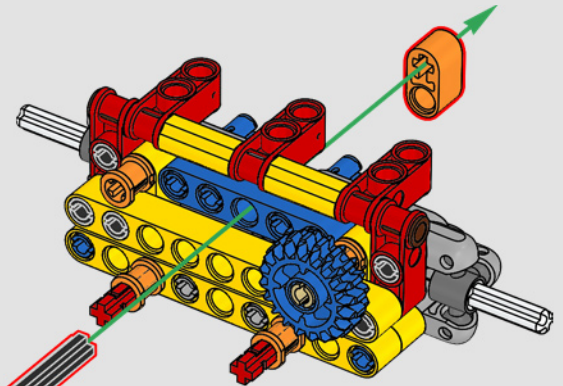
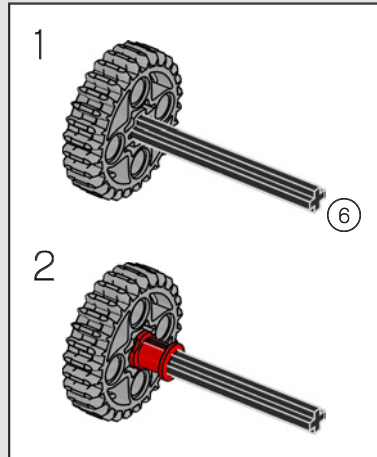

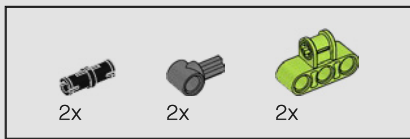

75

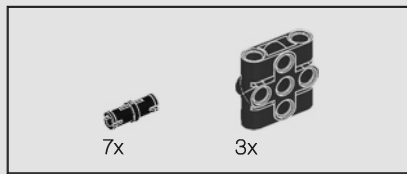
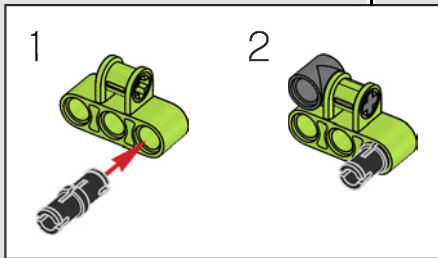
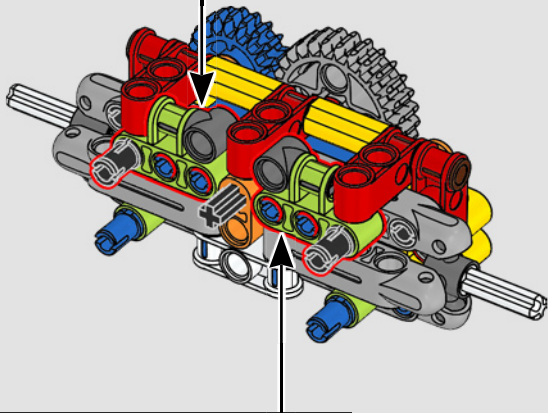
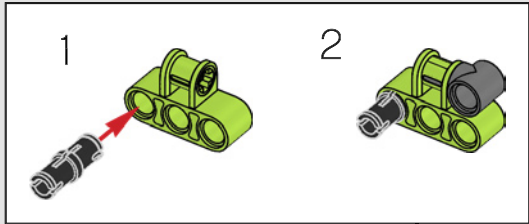

76

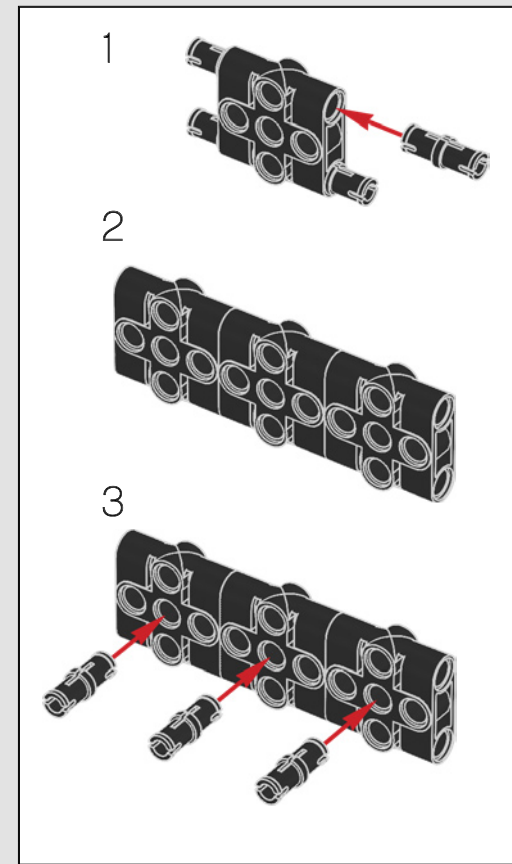
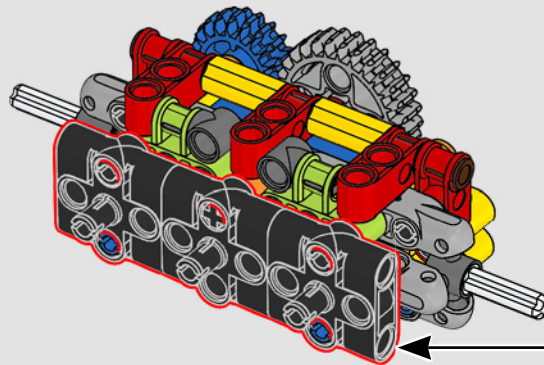

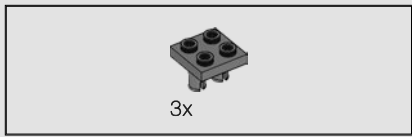

77

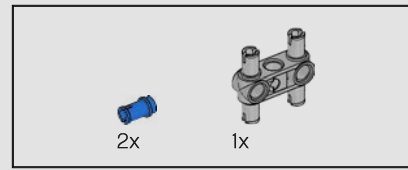
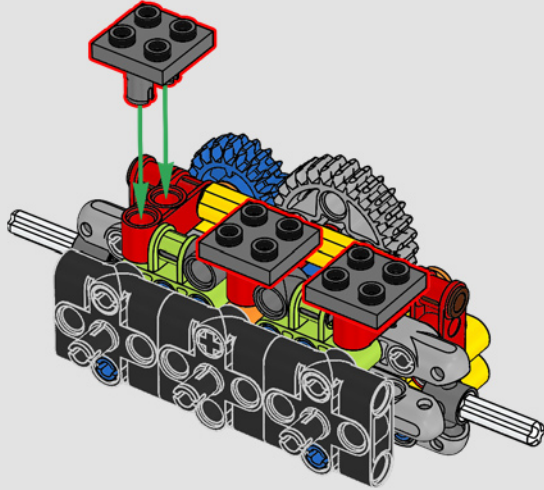

78

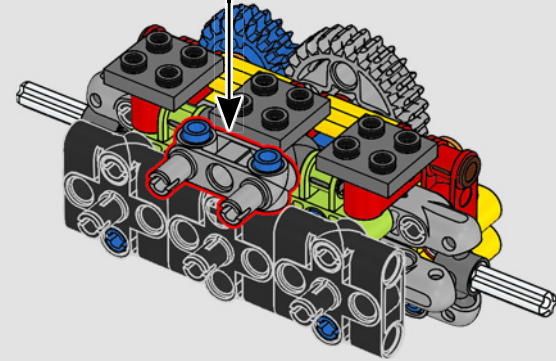
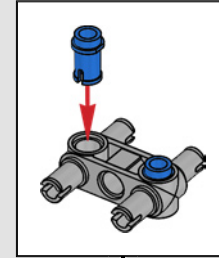

79

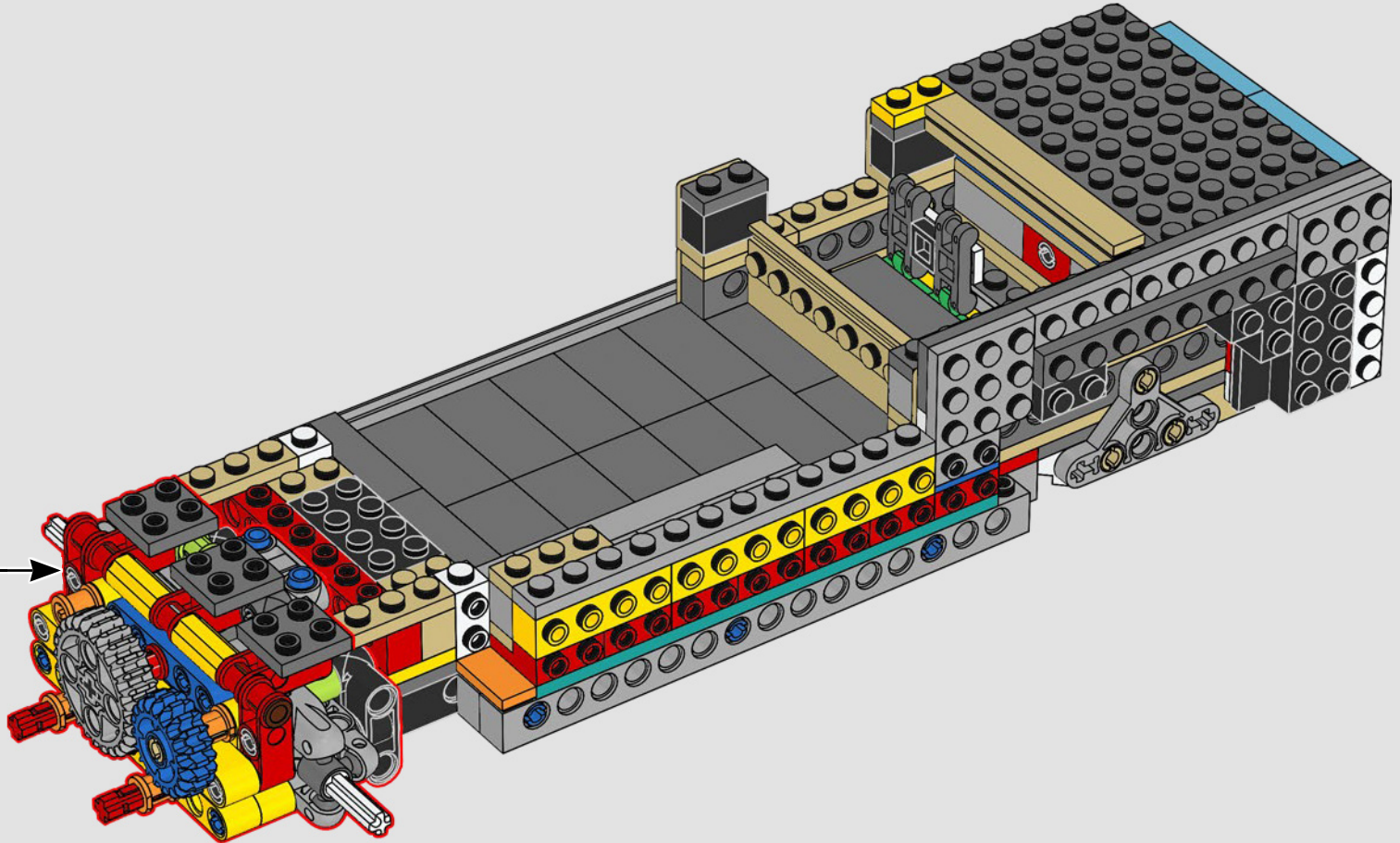

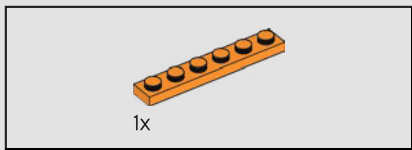

80

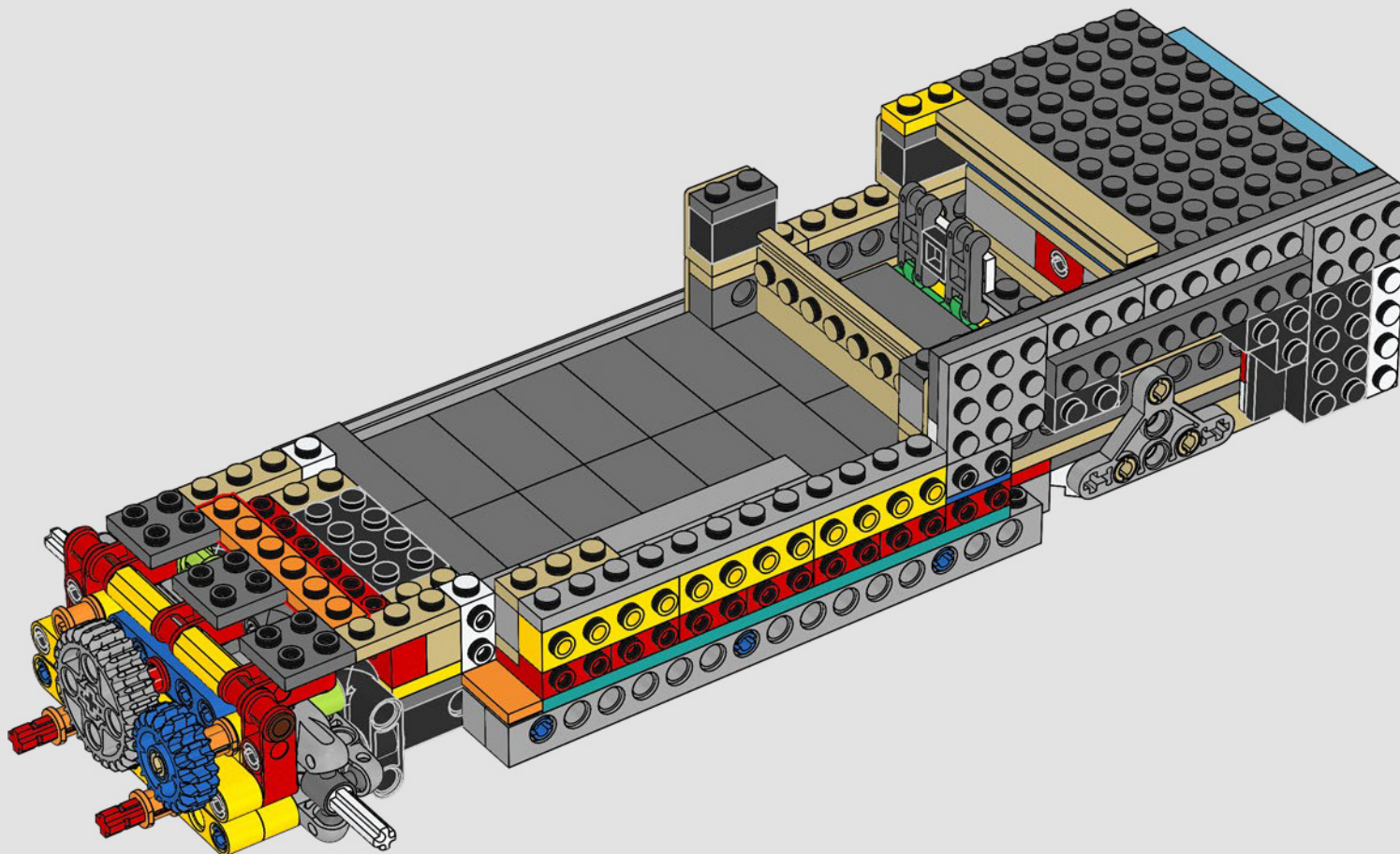

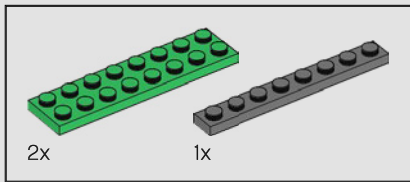

81

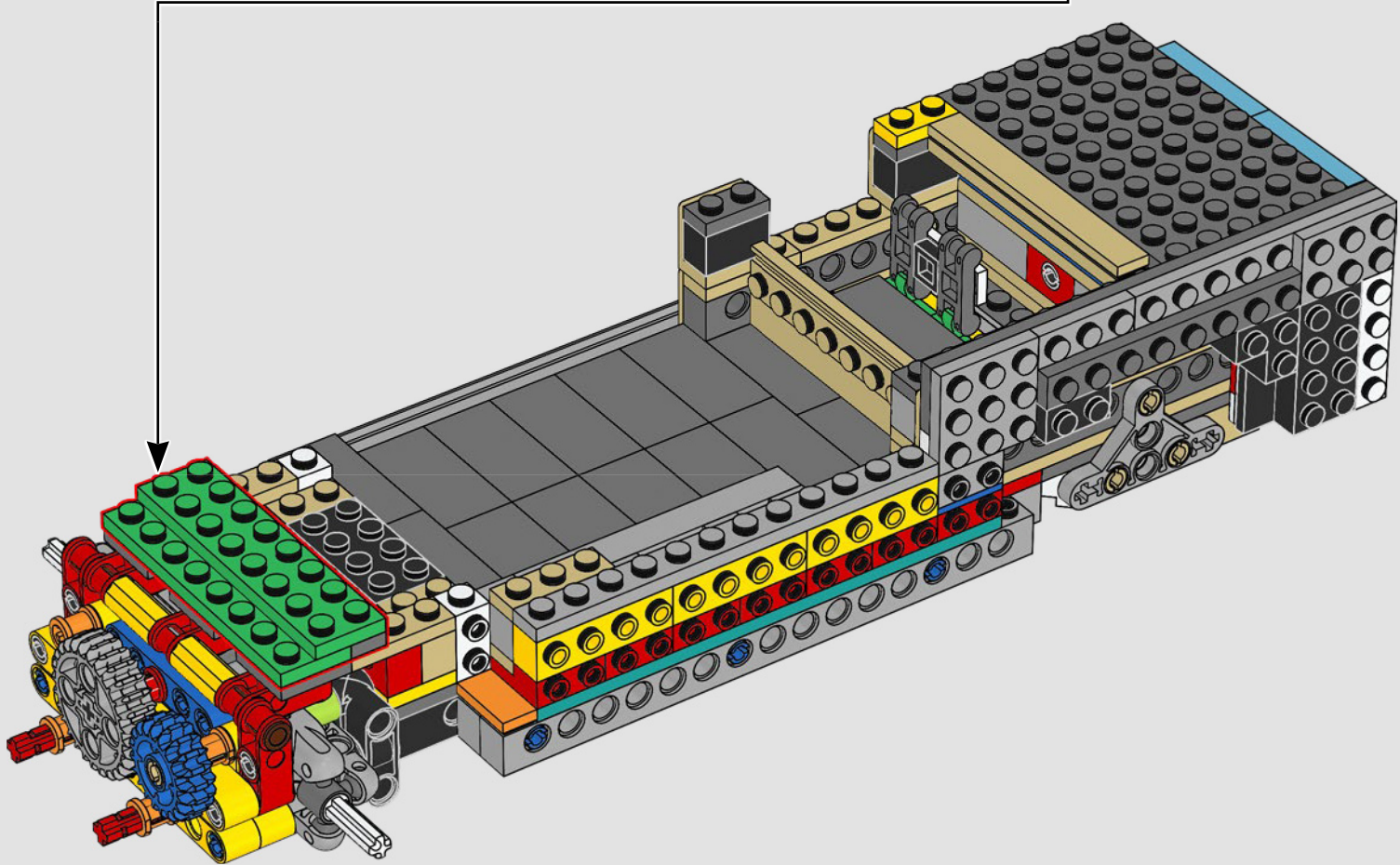
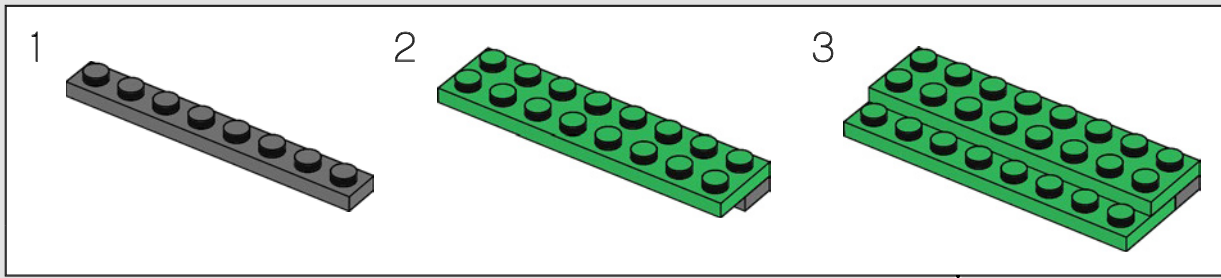

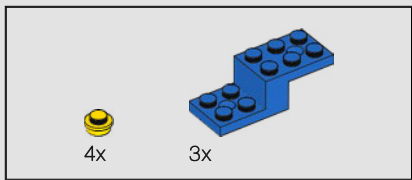

82

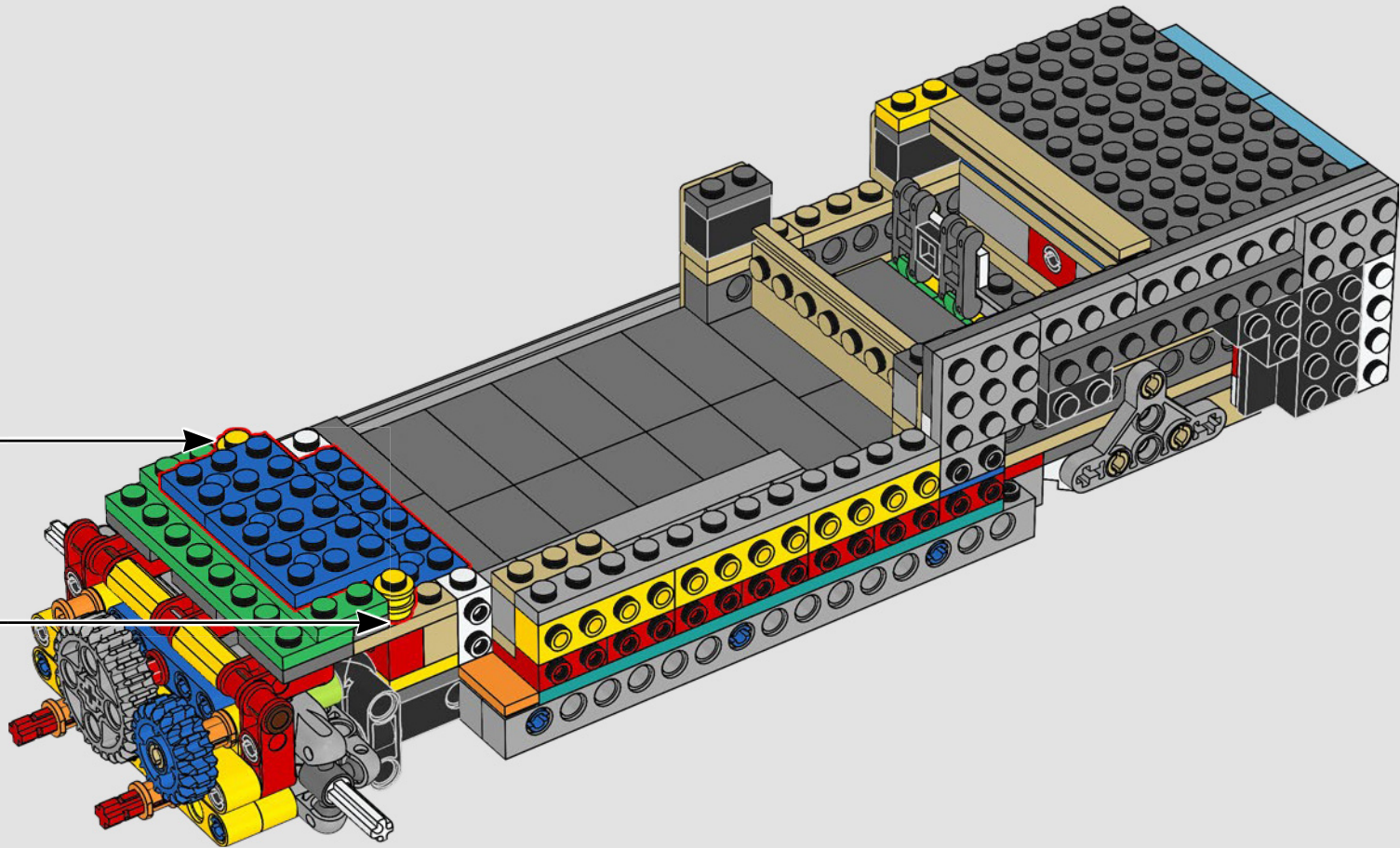
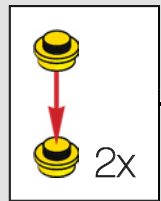

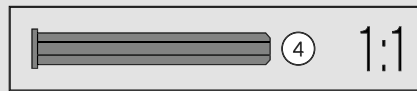
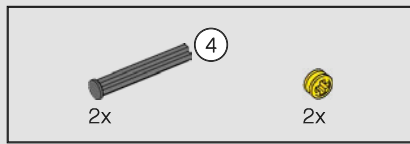

83

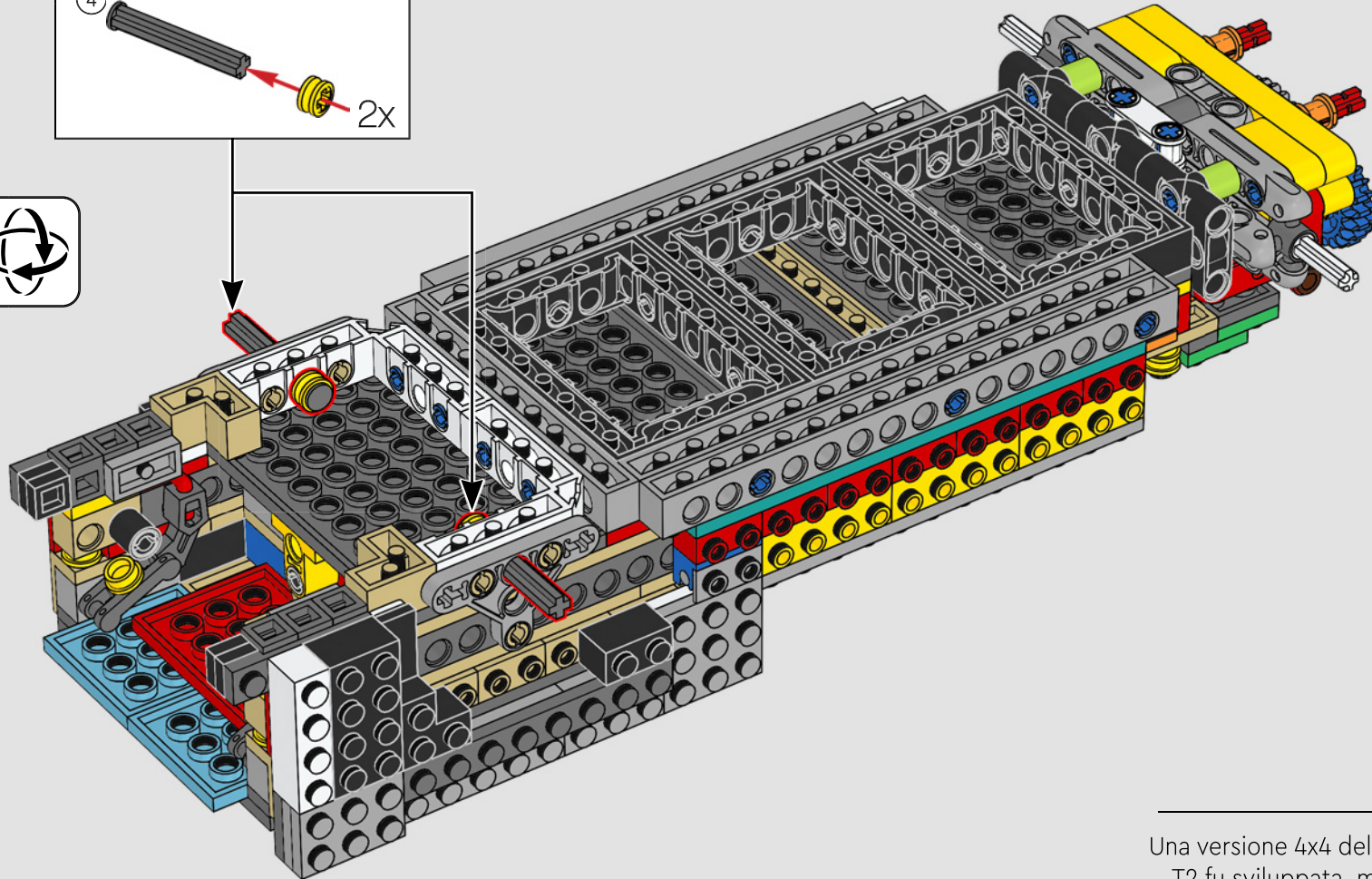
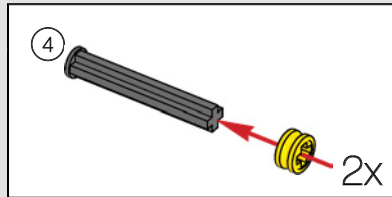

Una versione 4x4 del Transporter T2 fu sviluppata, ma non entrò mai in produzione. La tecnologia fu poi adottata sul modello T3, denominato "Syncro".

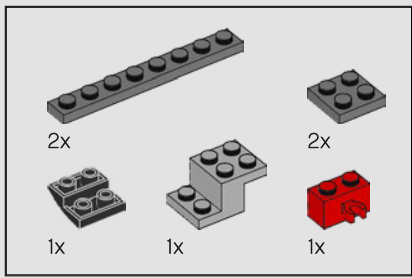

84

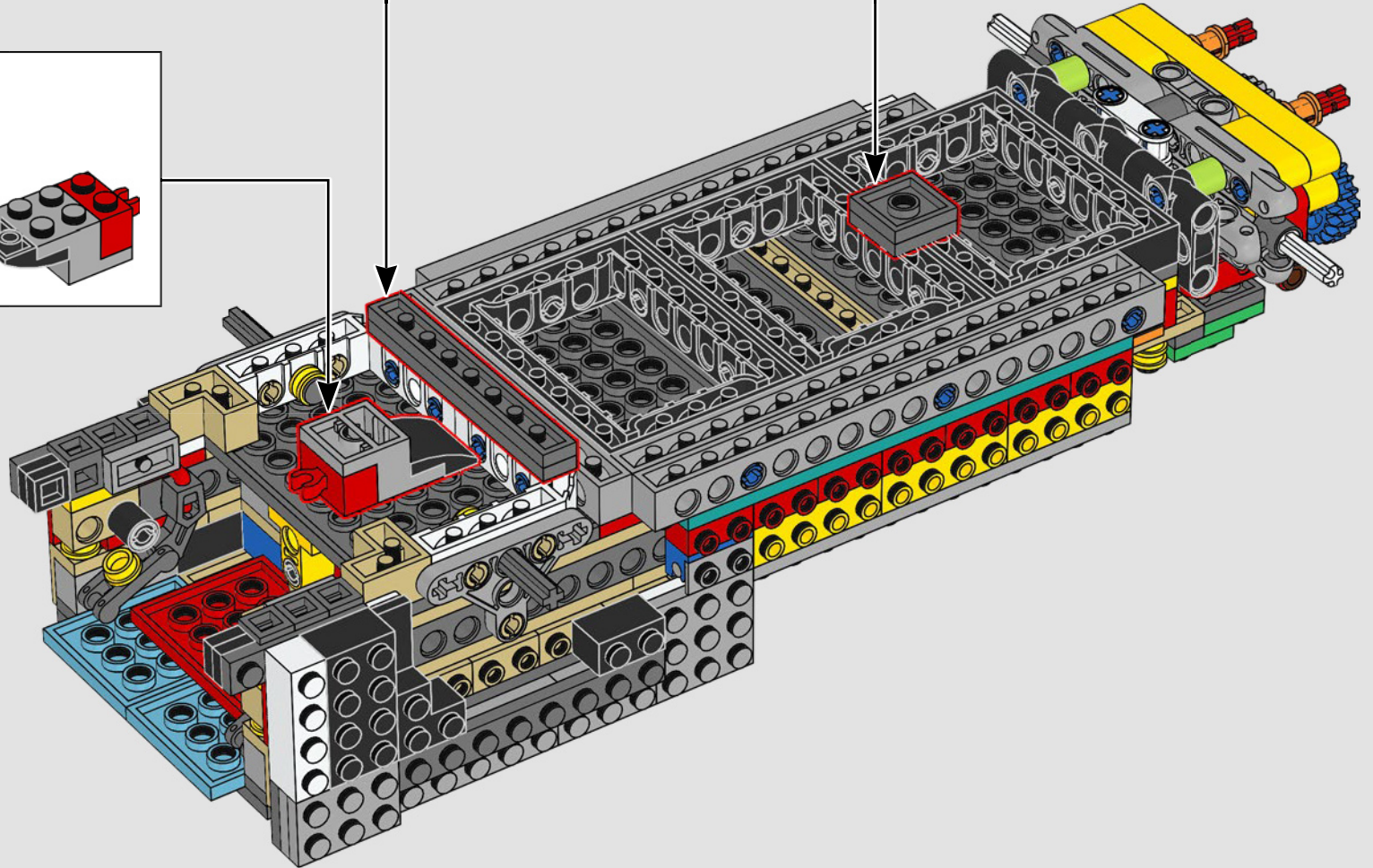
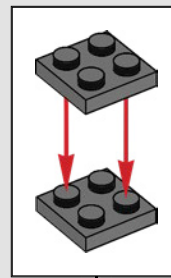
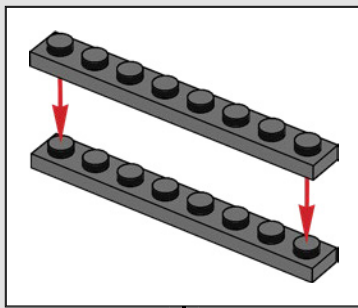
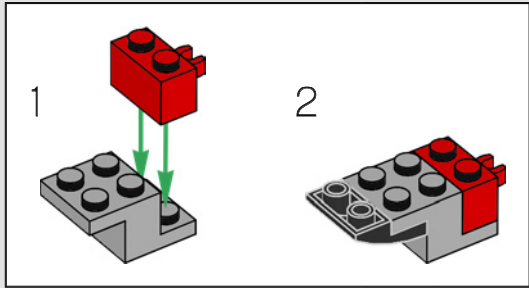

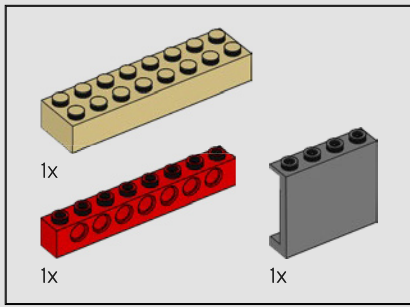

85

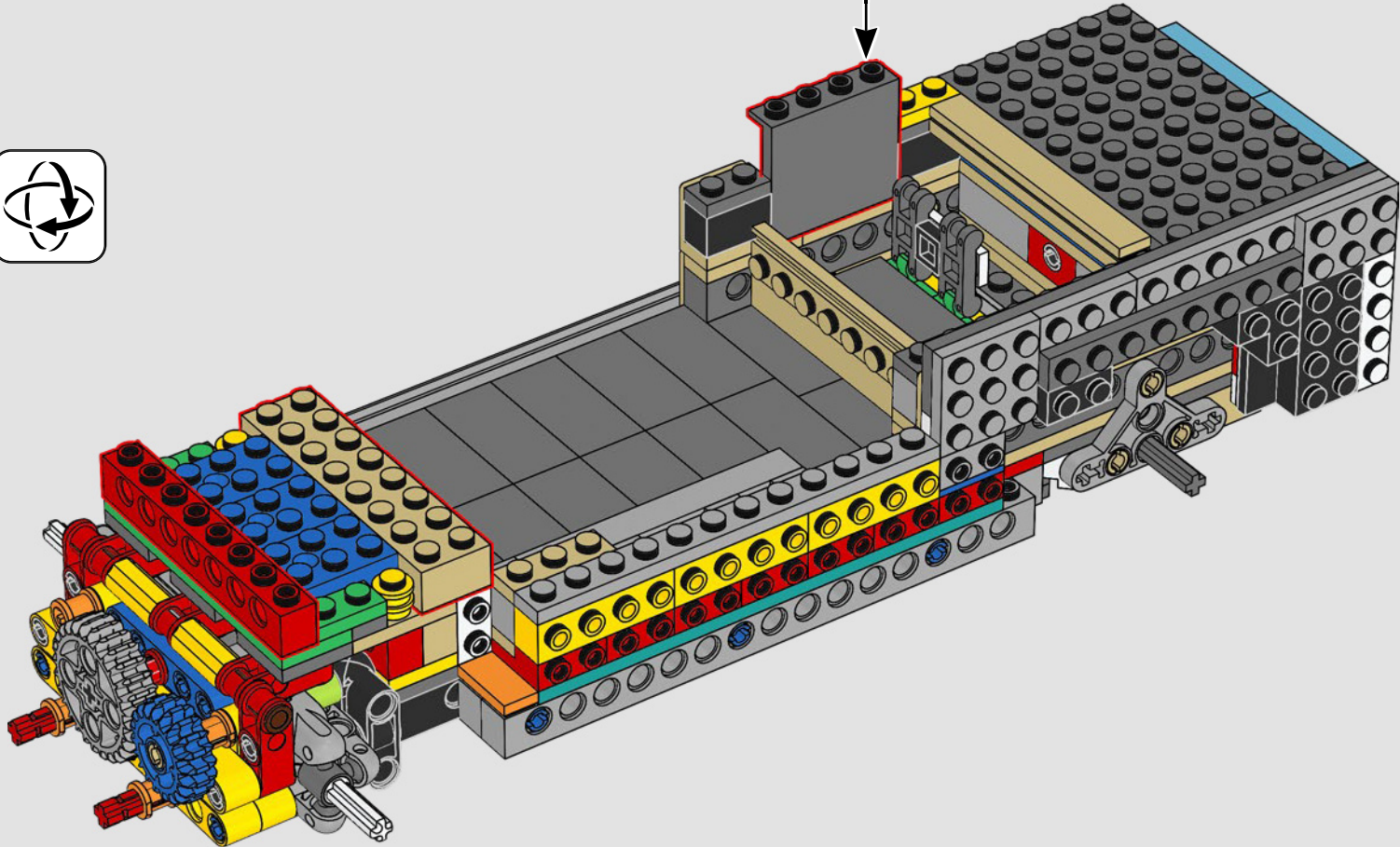
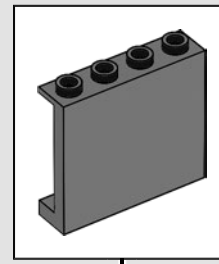

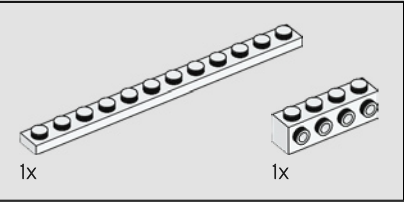
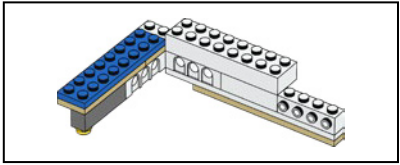
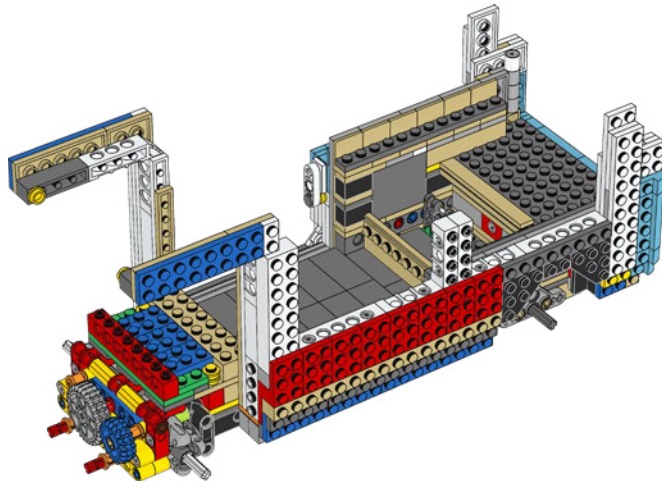
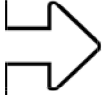

86

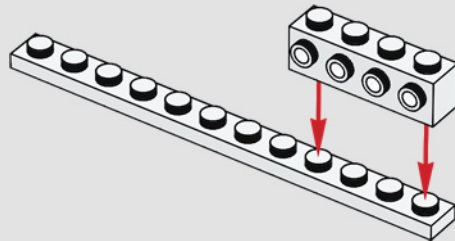

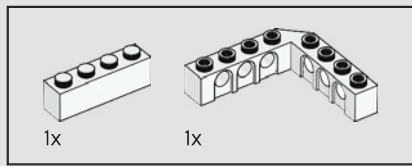

87

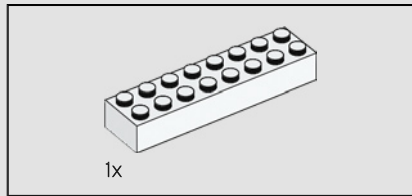
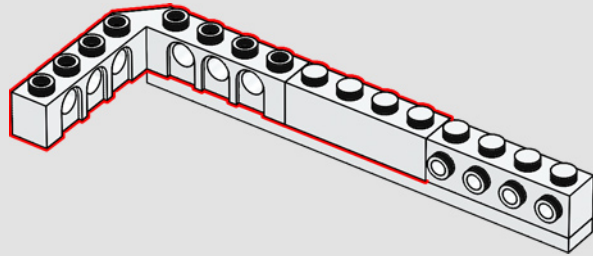

88

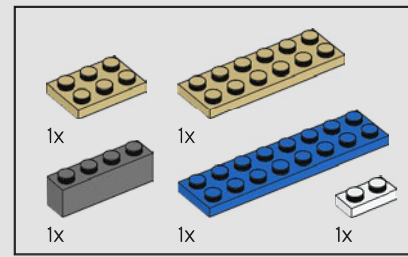
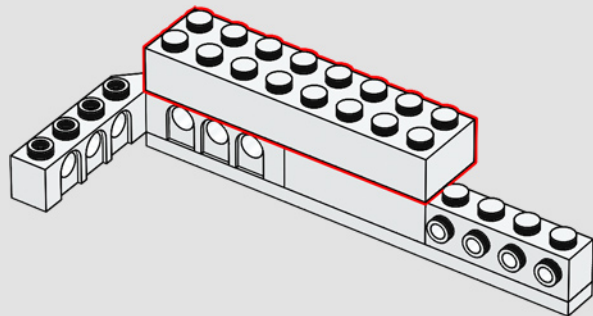

89

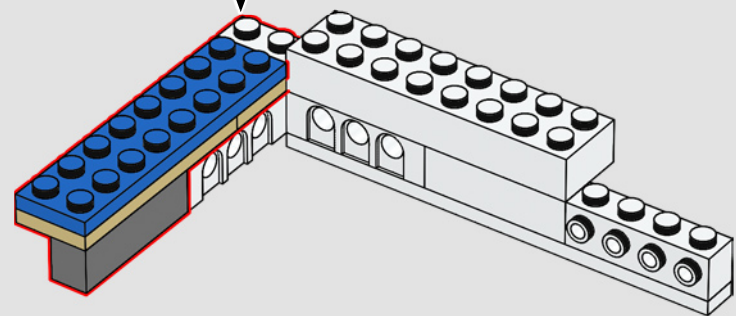
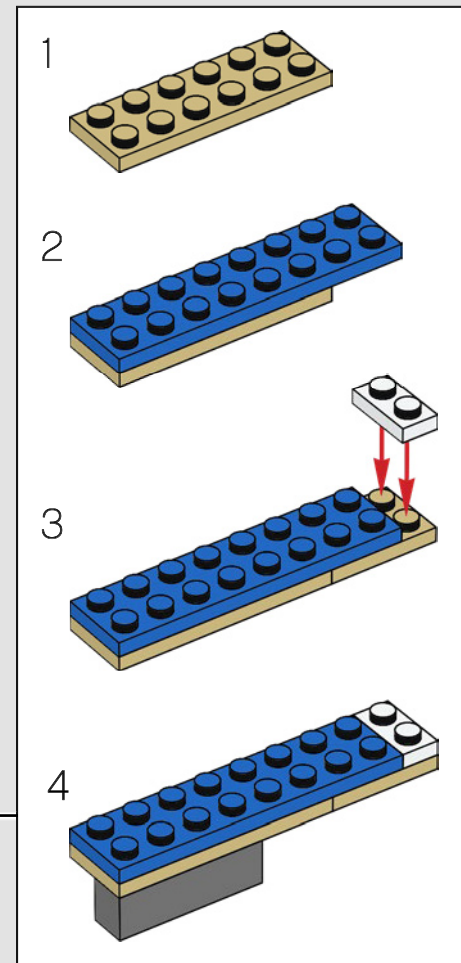

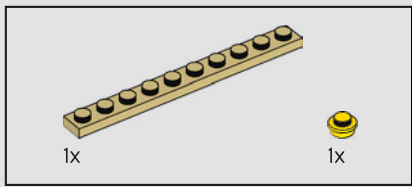

90

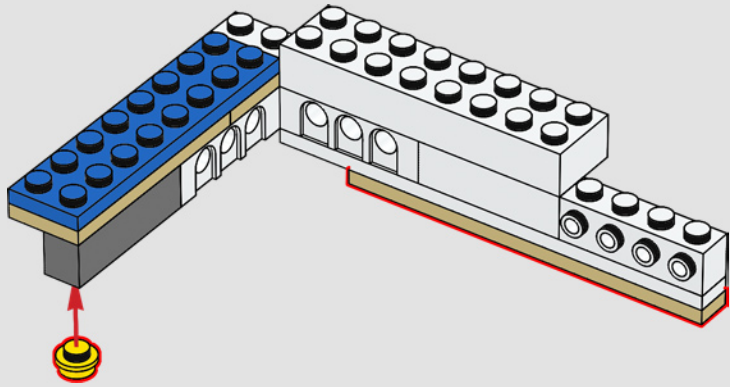

91

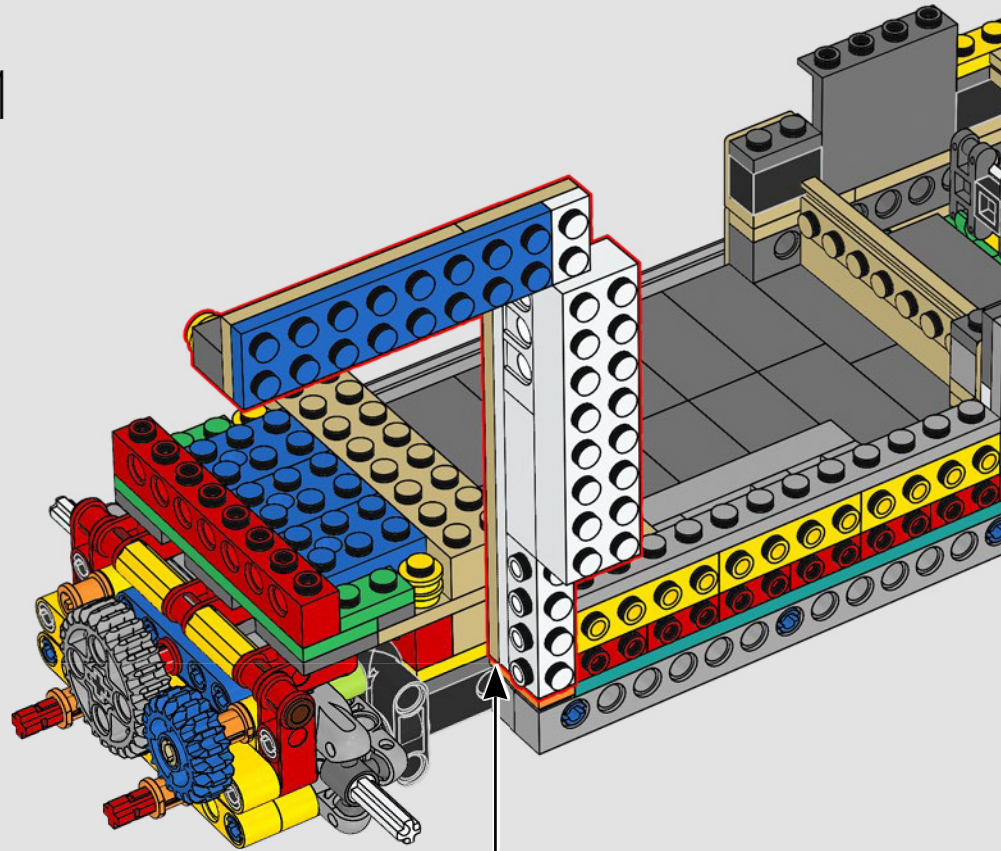

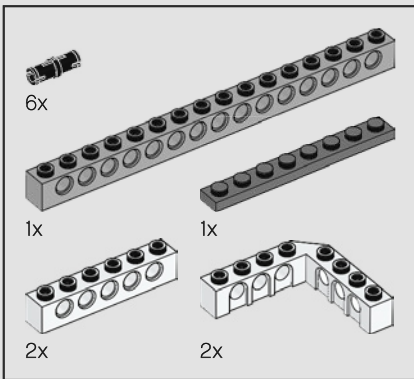
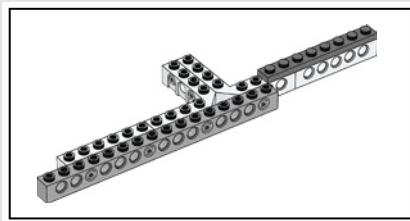

92

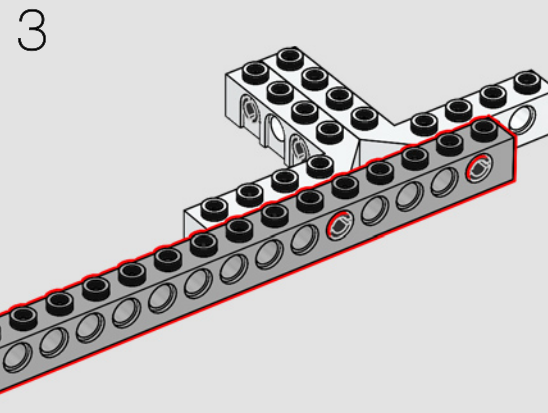
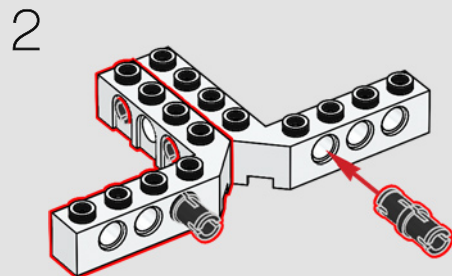
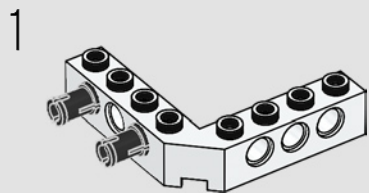

Dopo la sospensione della produzione del VW T2 nel 1979, per far posto al nuovo modello T3, il design T2 rimase in produzione in Brasile fino al 2013.

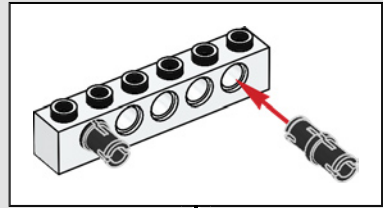

4

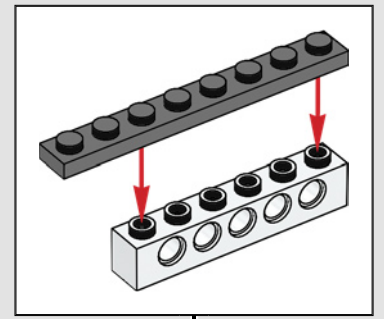
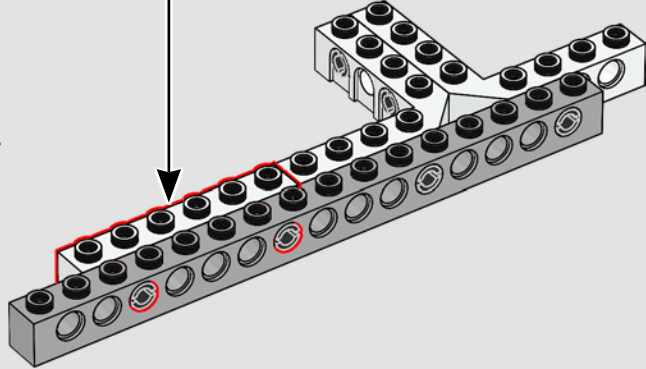

5

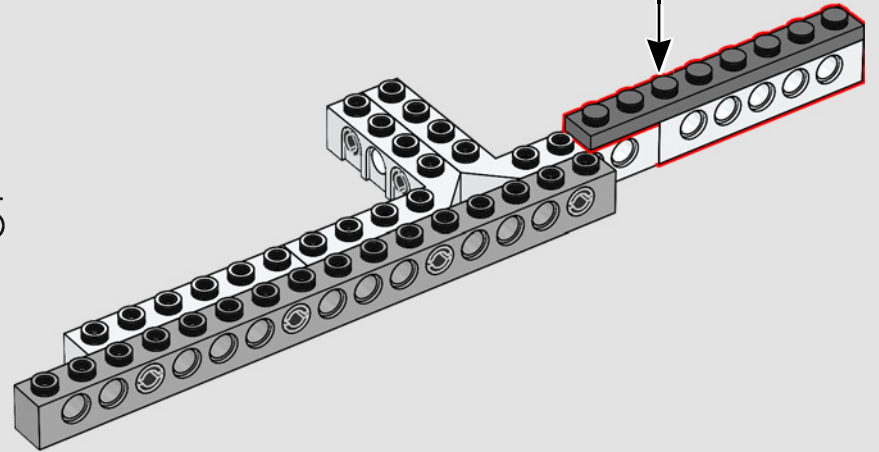

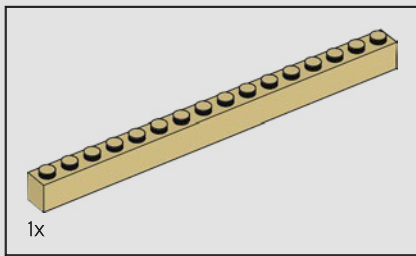

94

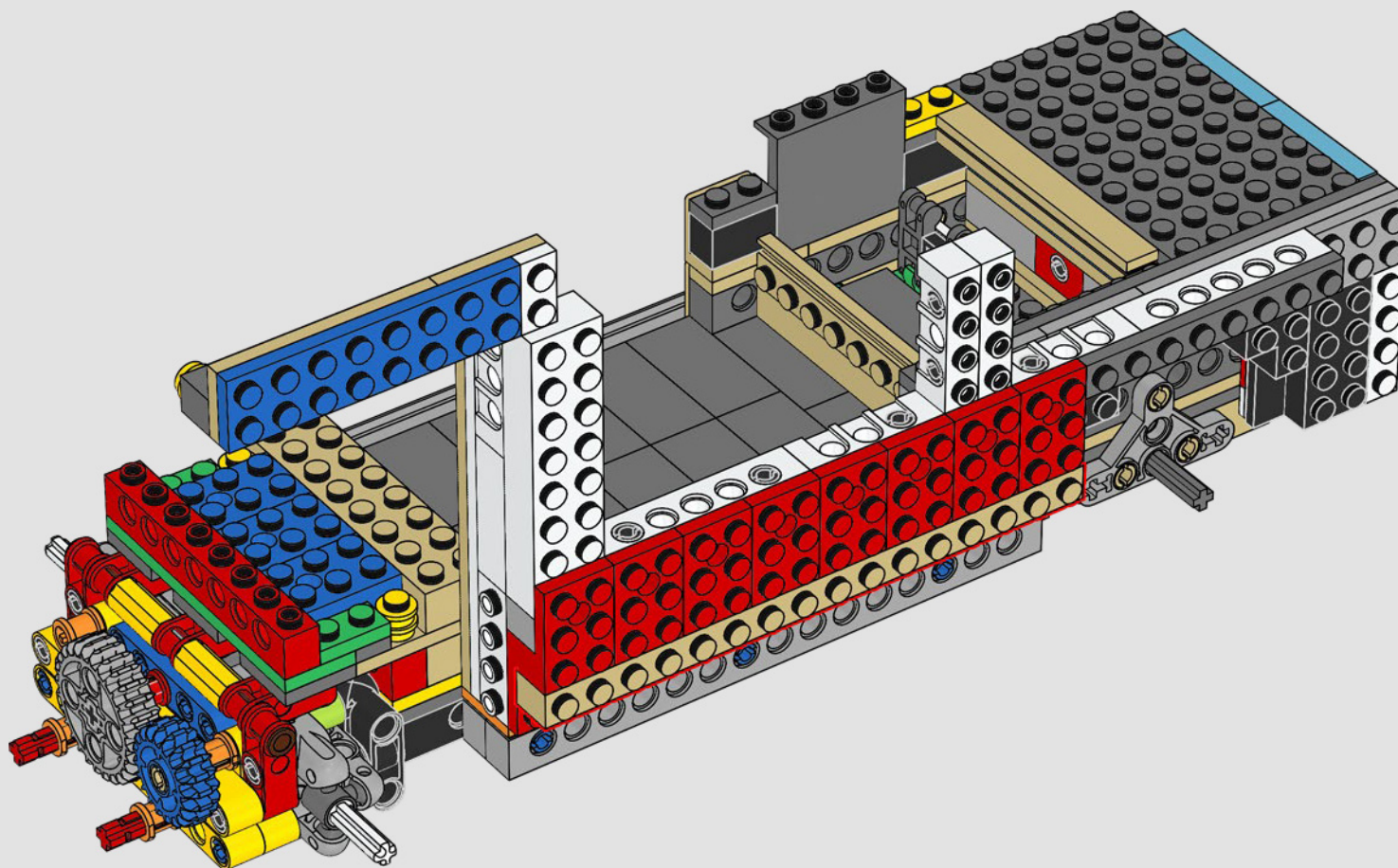

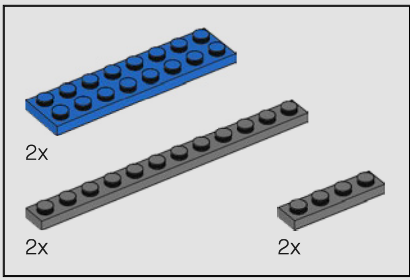

95

1

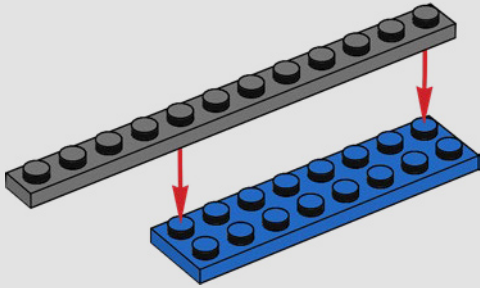

2

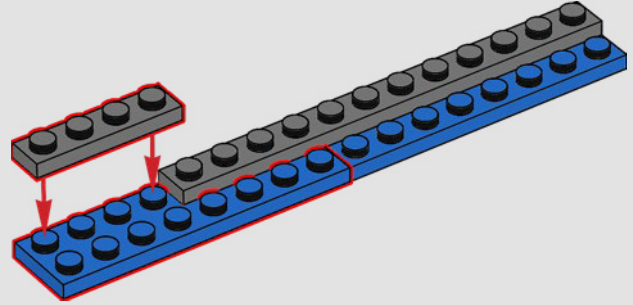

3

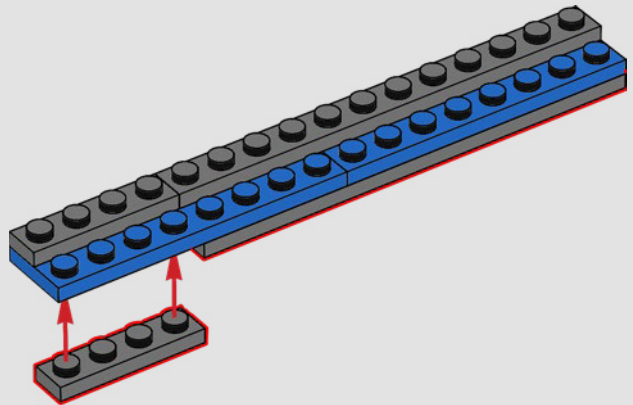

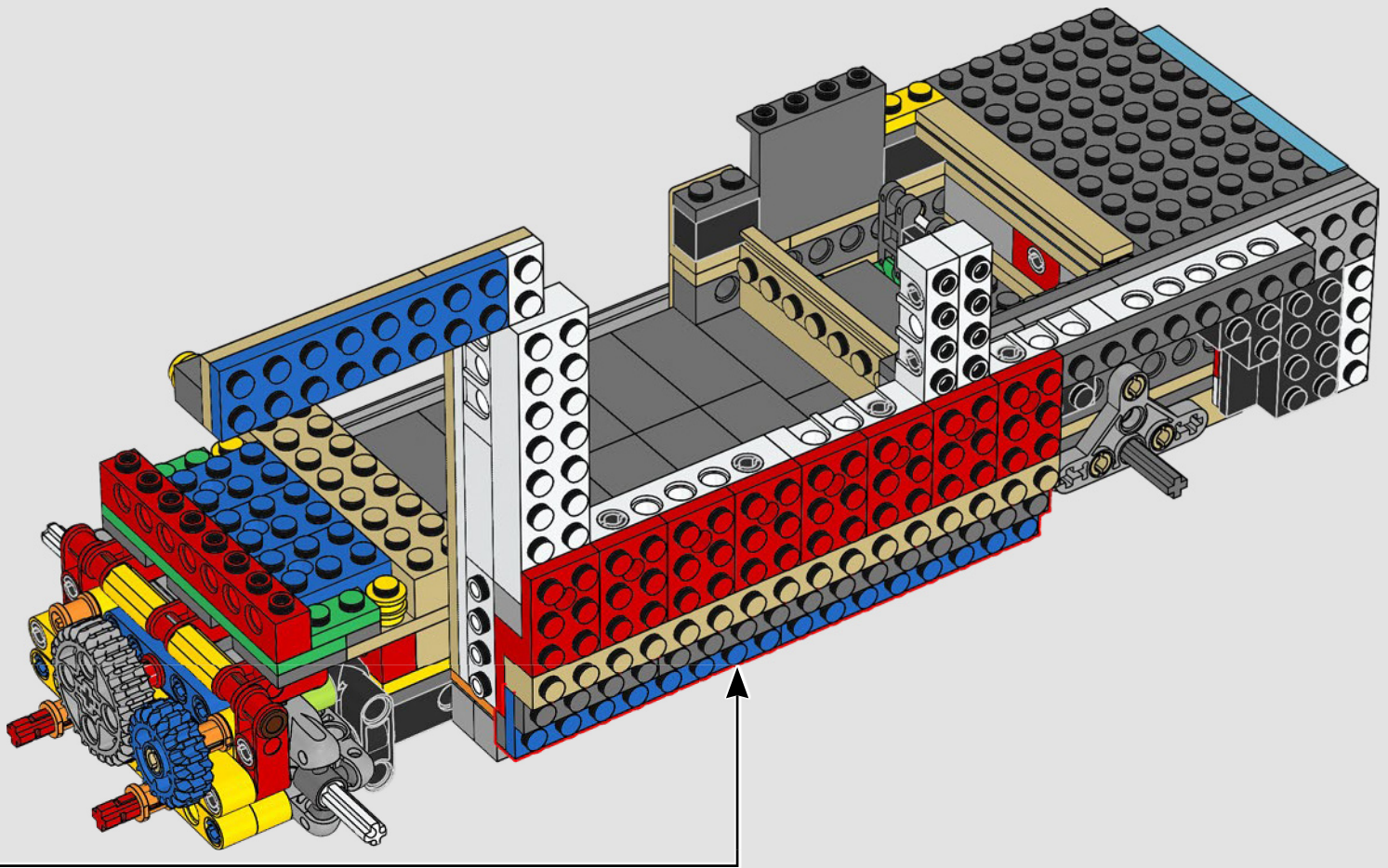

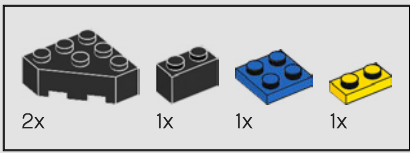

96

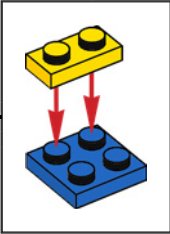
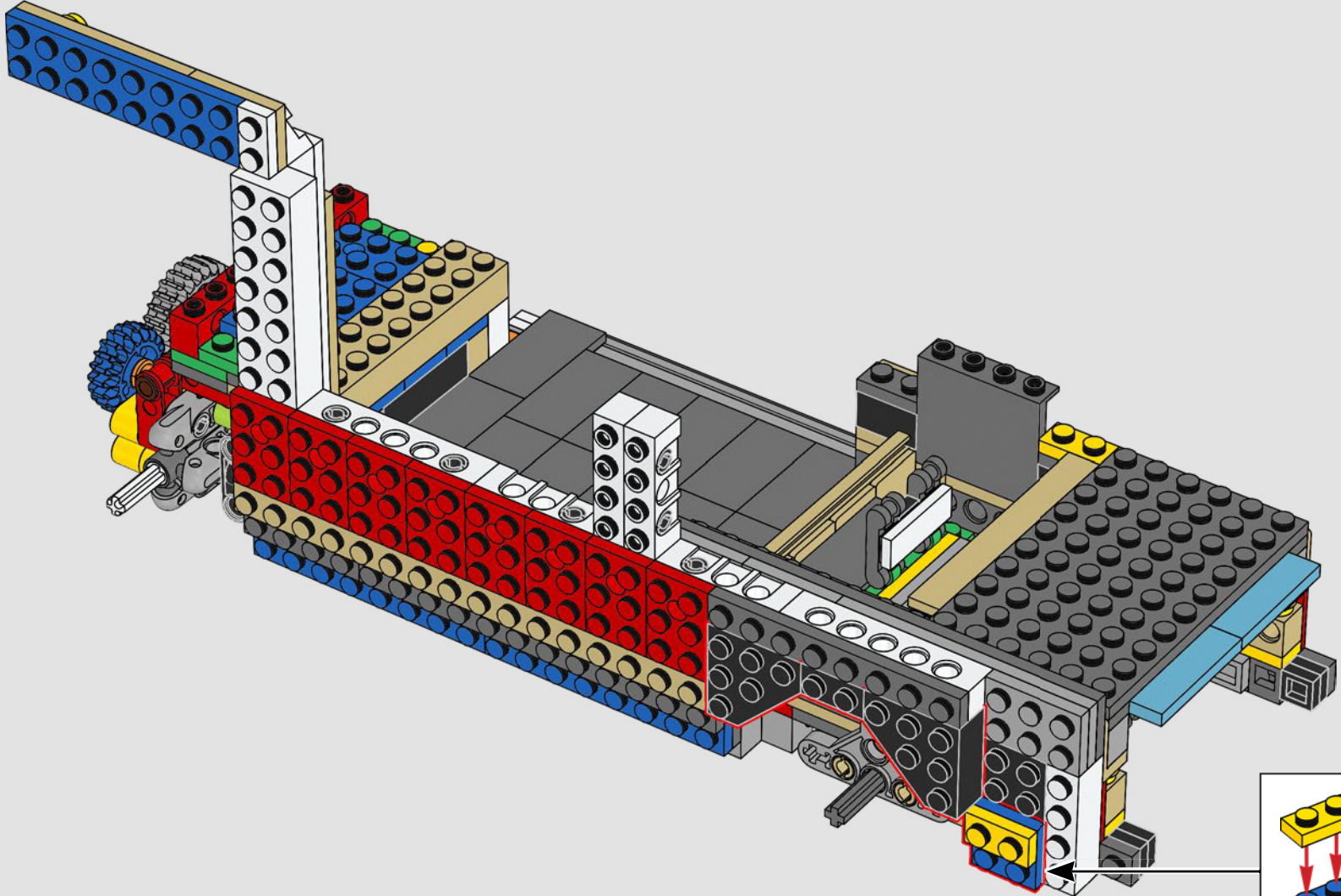

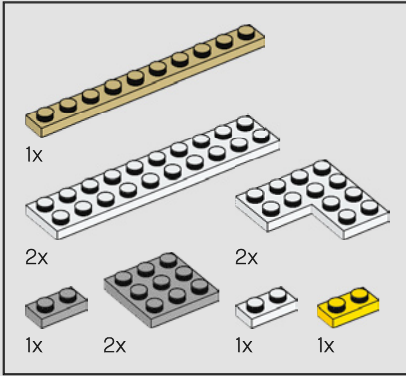
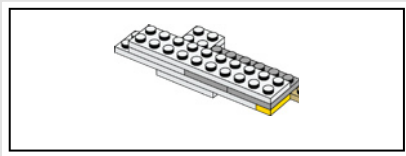

97

1

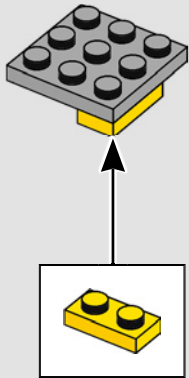

2

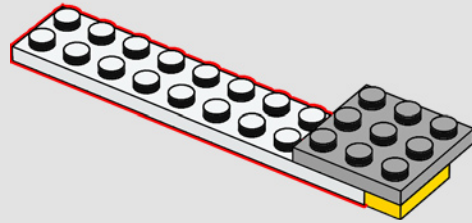

3

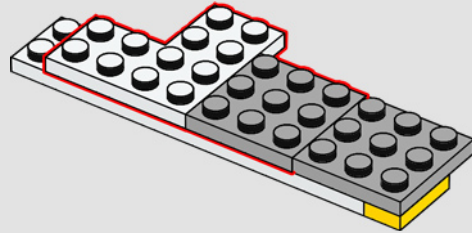

4

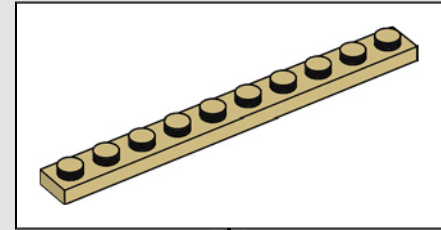
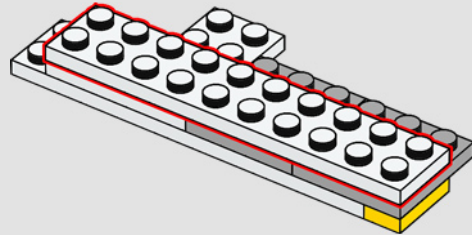

5

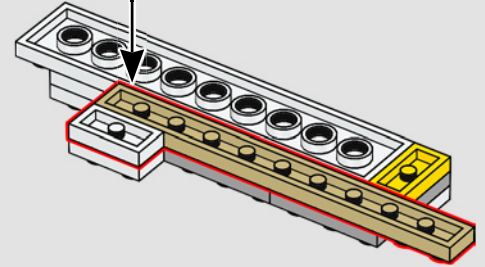

6

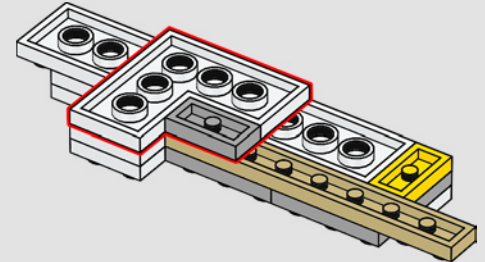

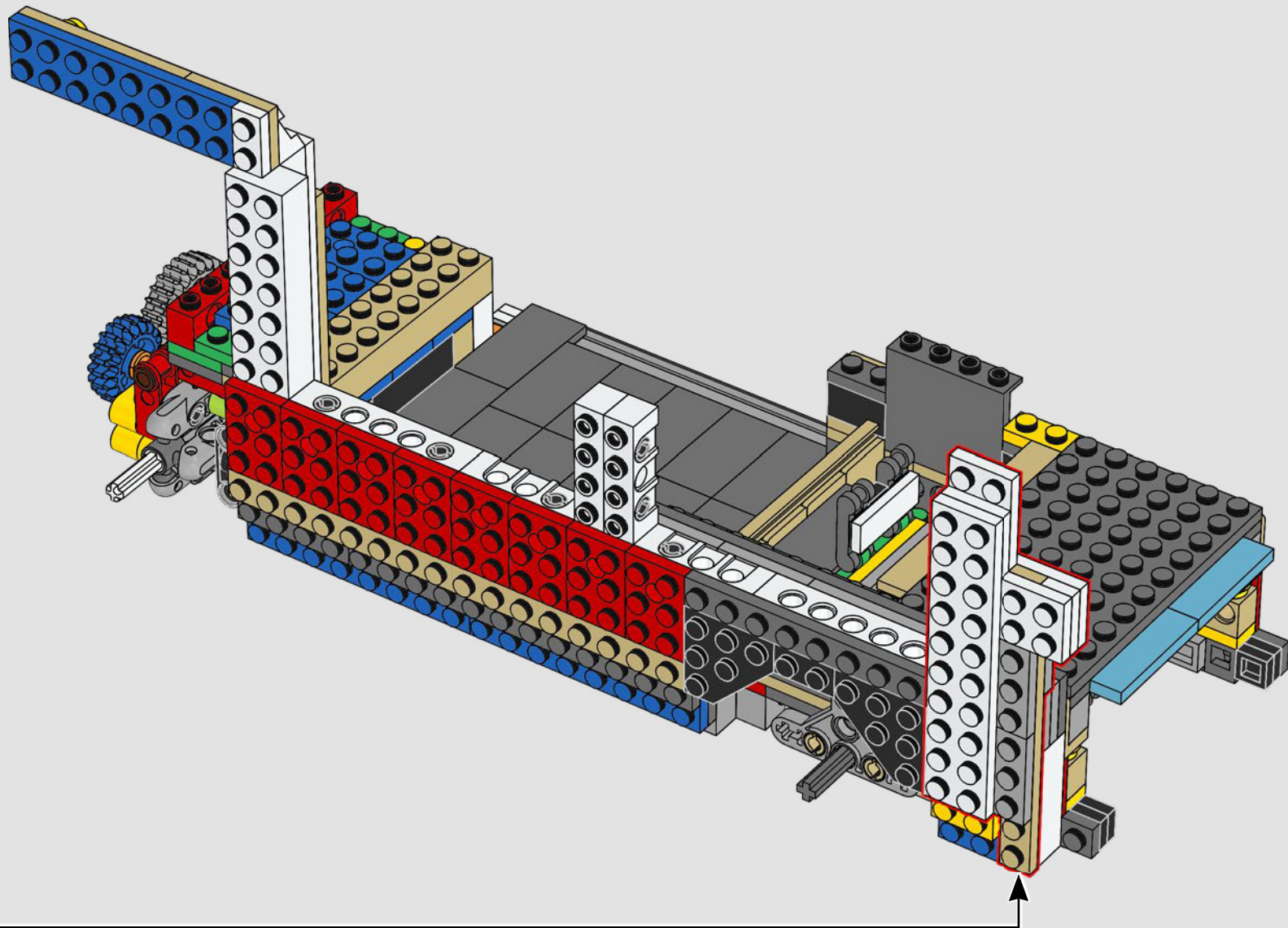

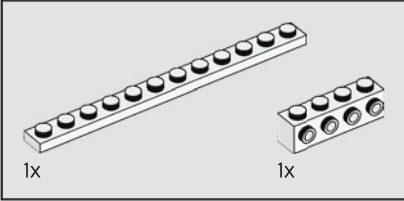
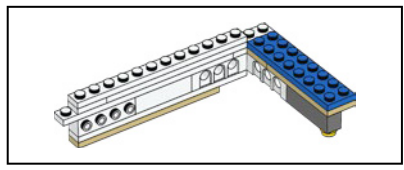

98

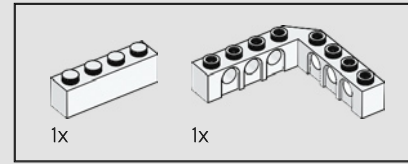
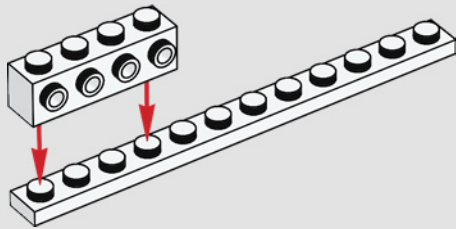

99

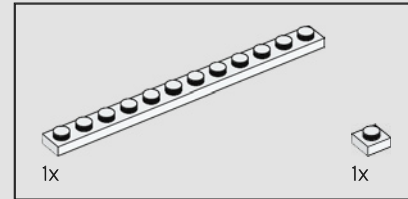
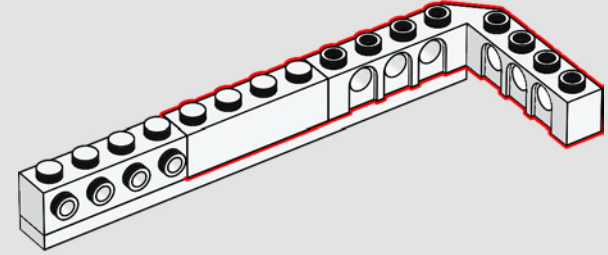

100

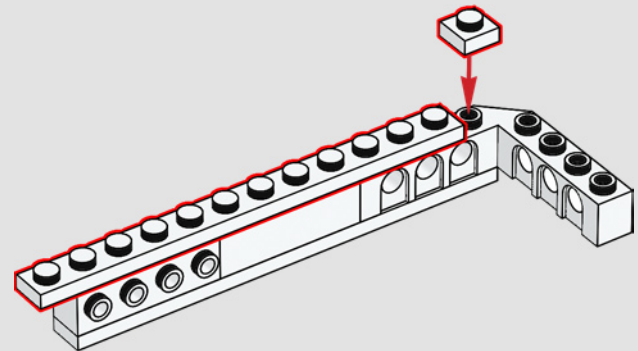

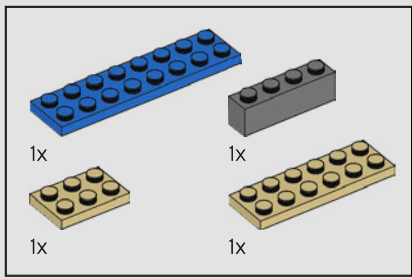

101

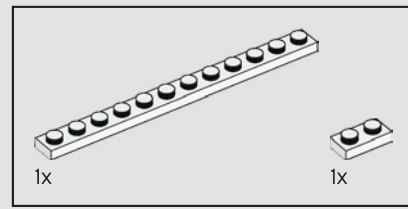
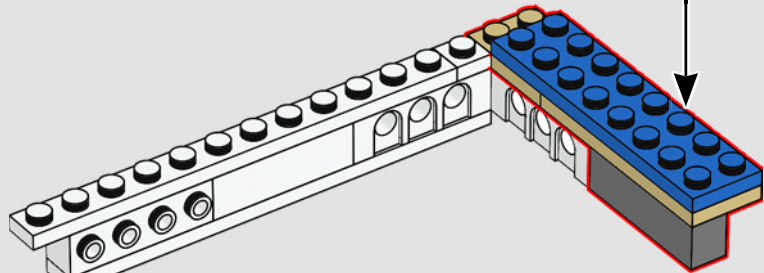
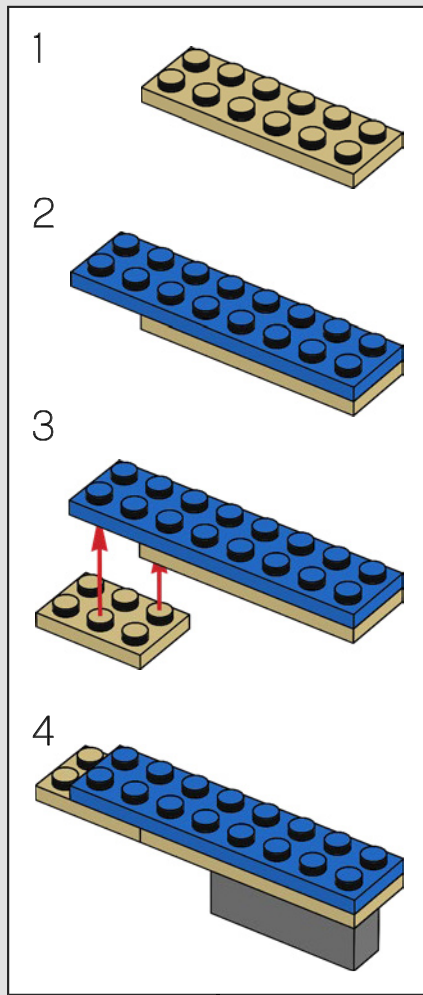

102

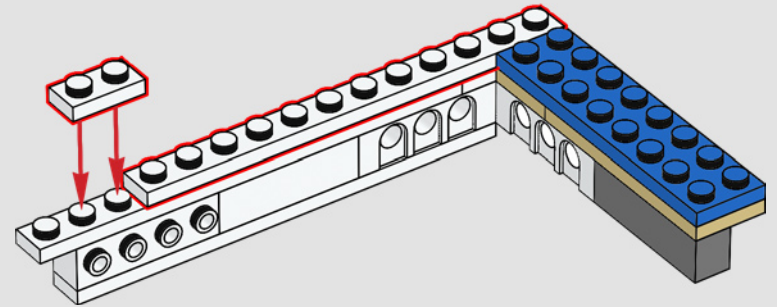

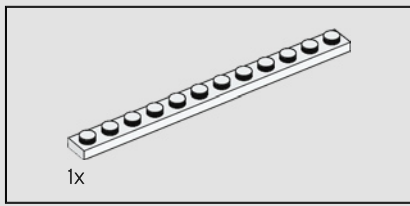

103

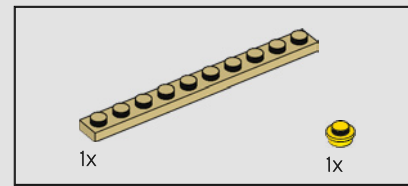
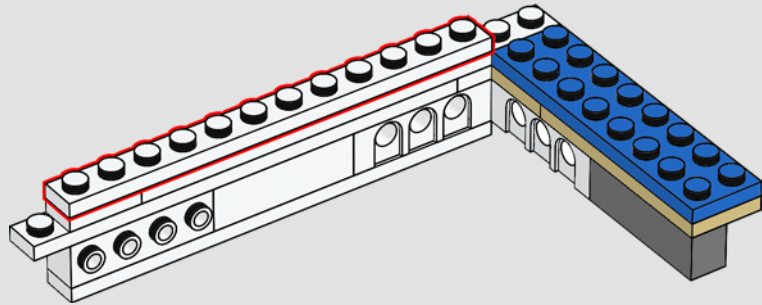

104

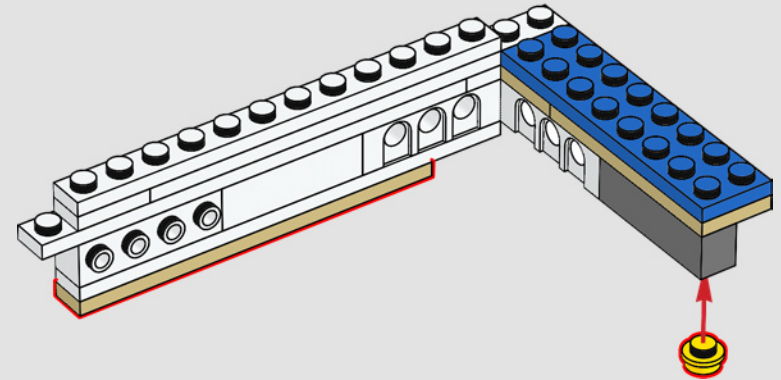

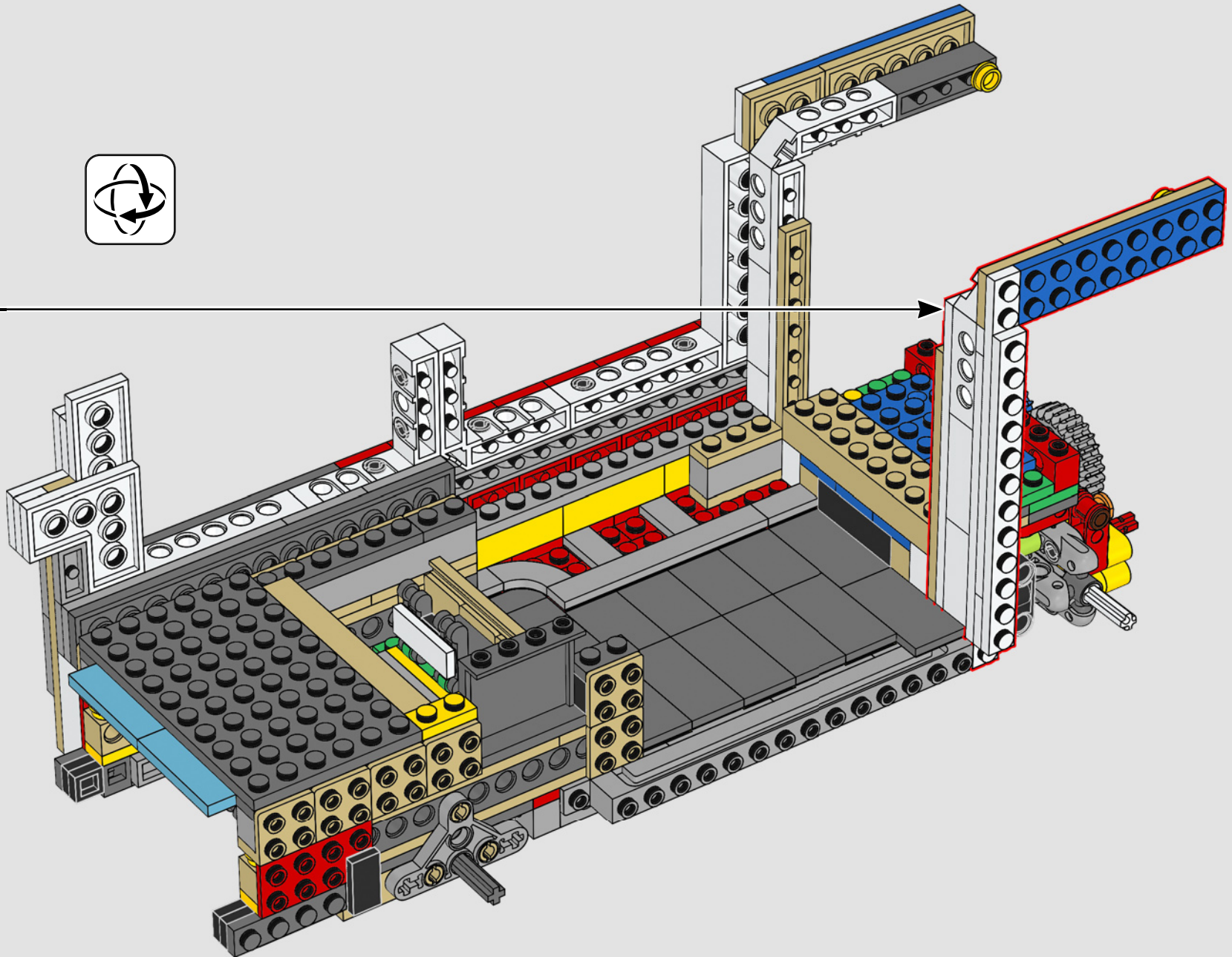

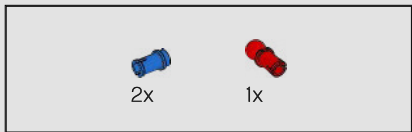

106

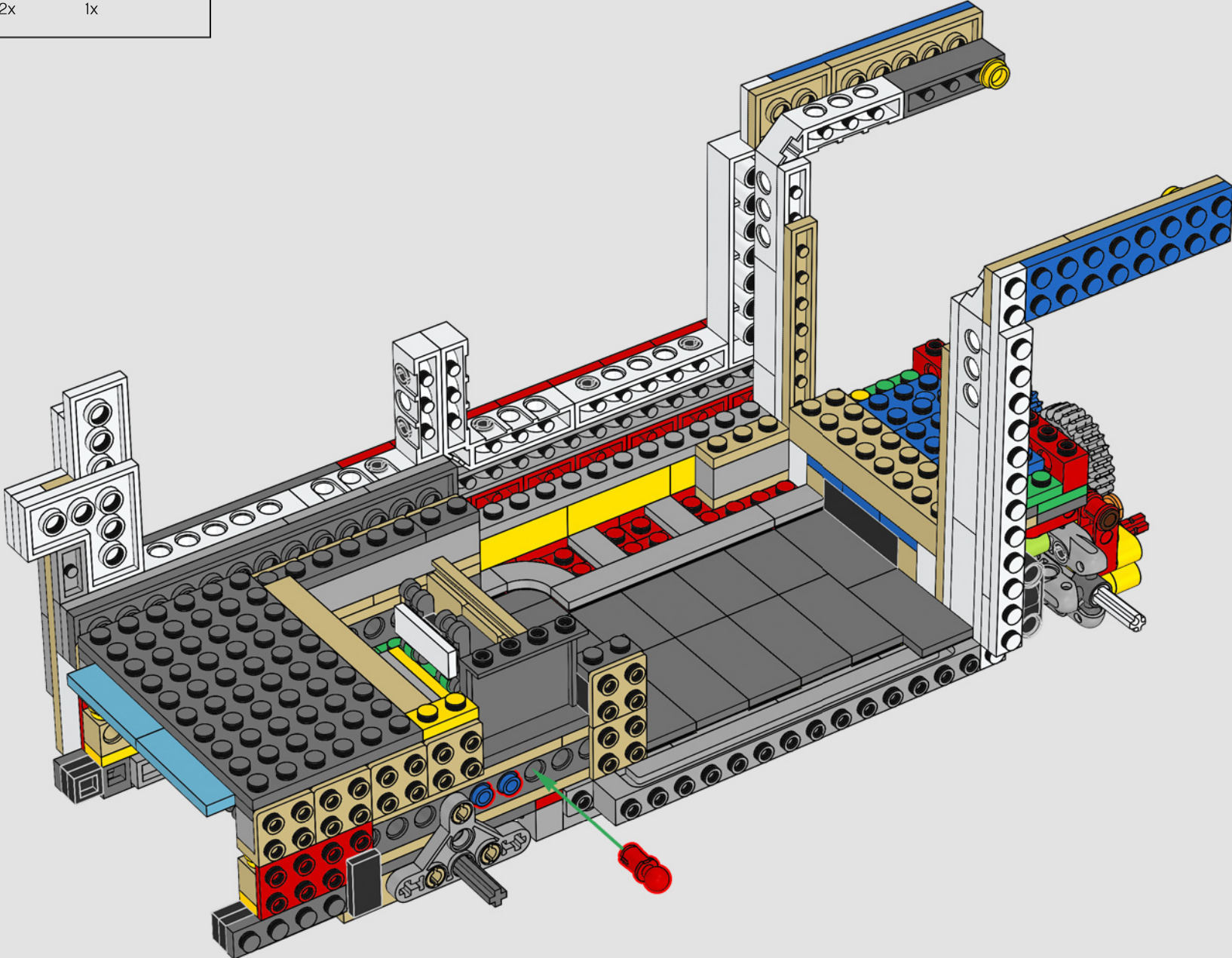

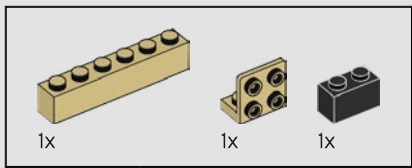

107

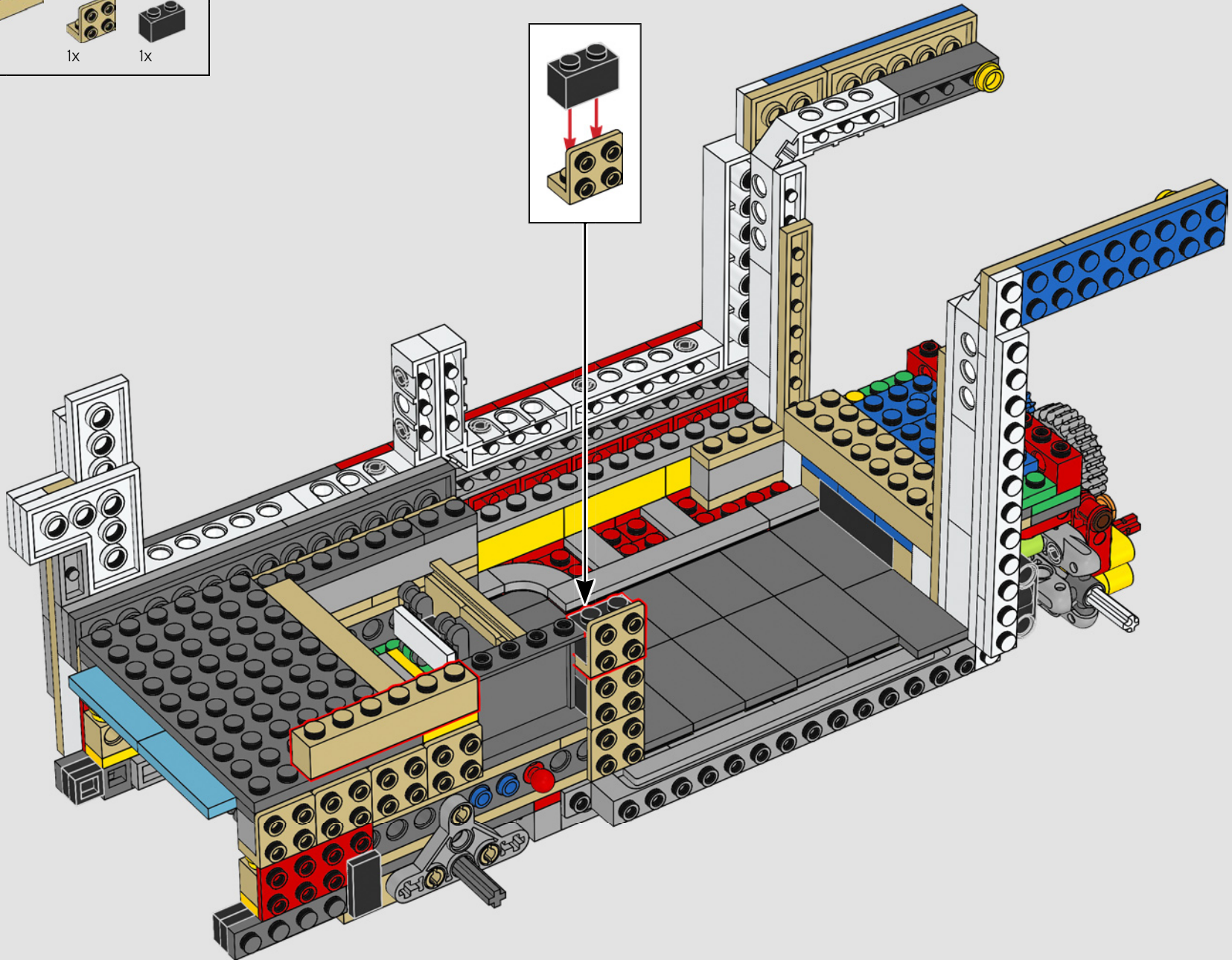
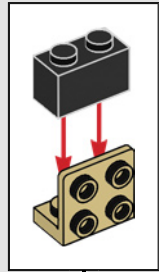

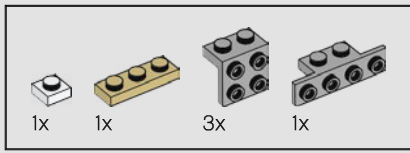

108

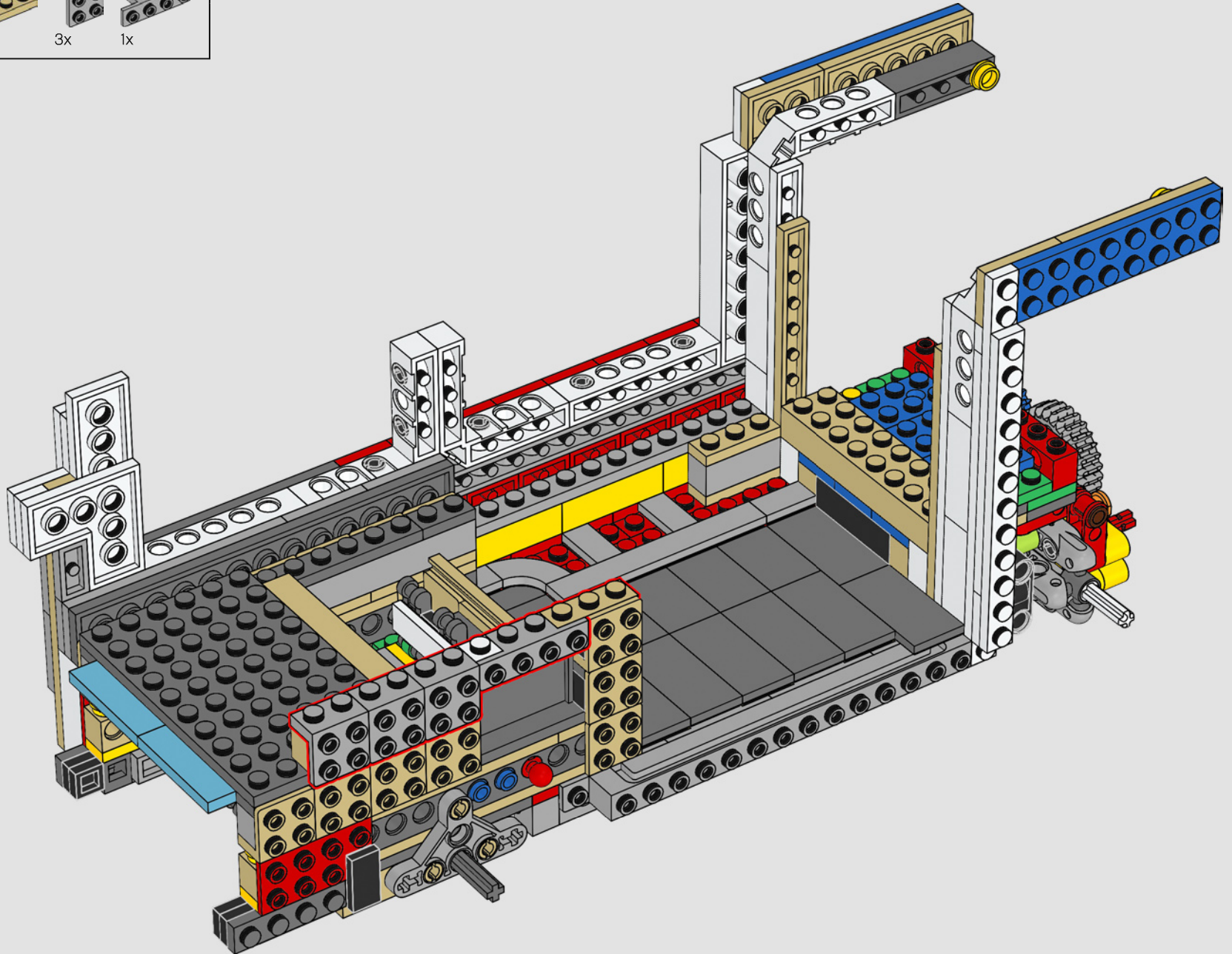

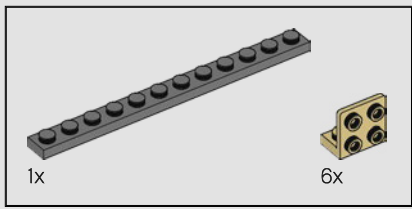

109

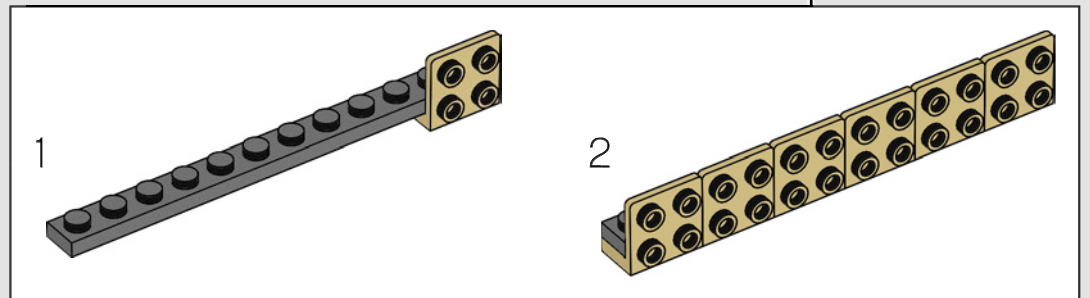
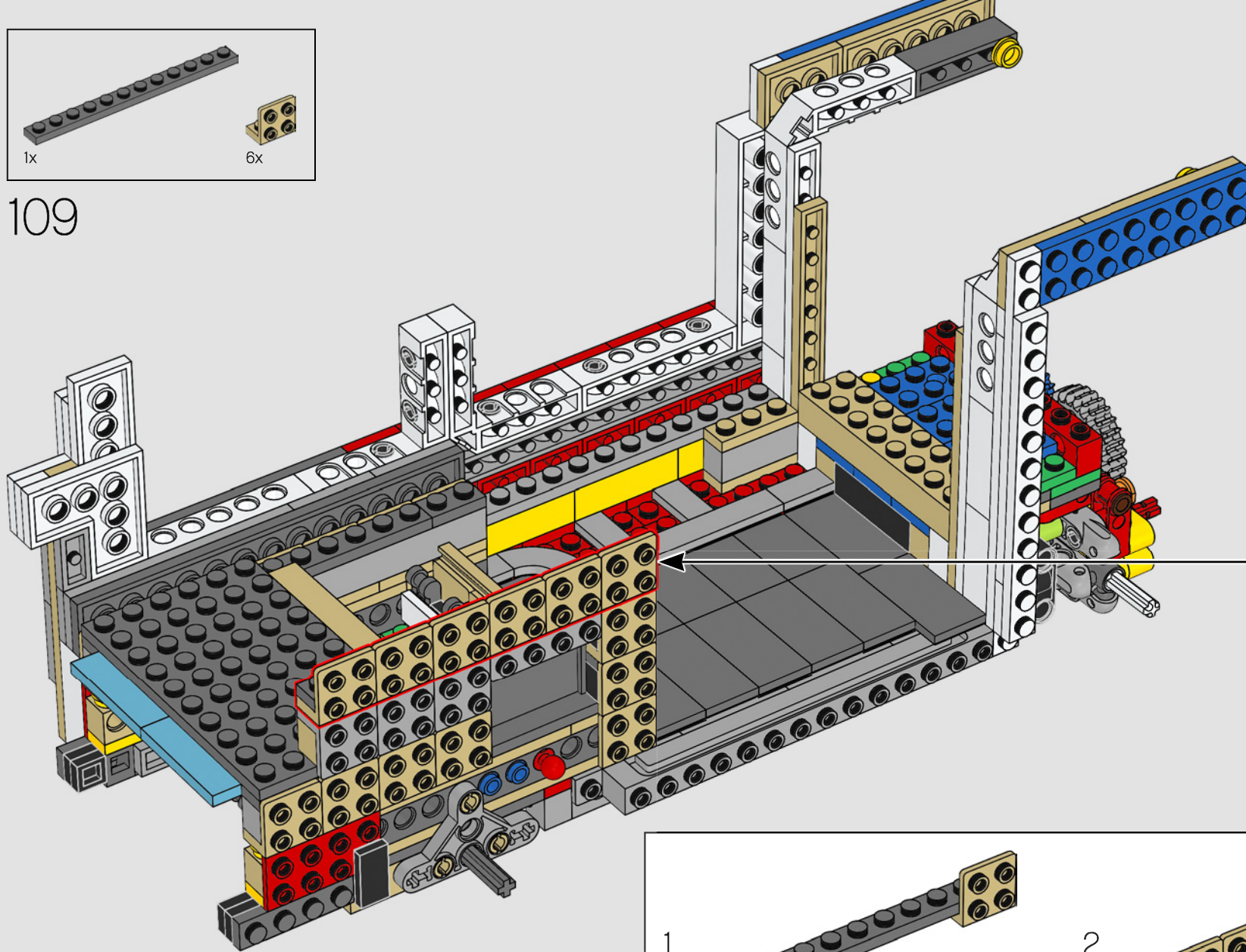

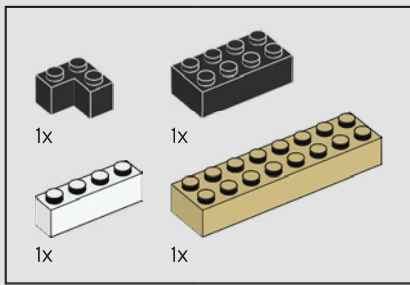

110

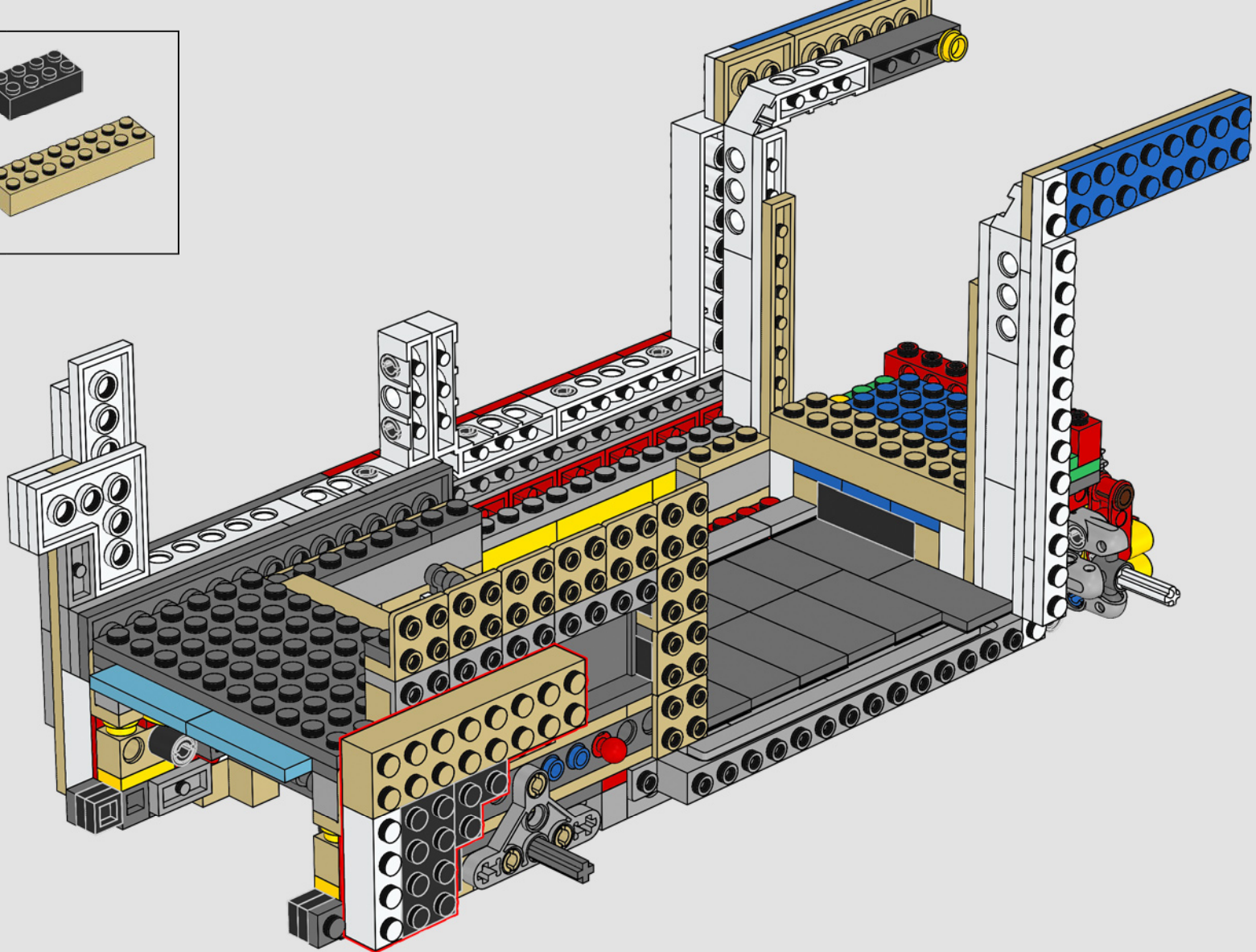

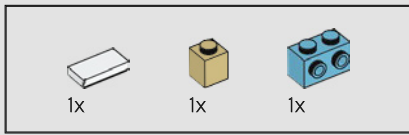
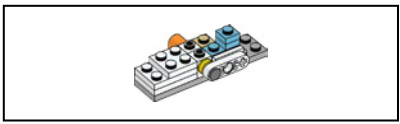

113

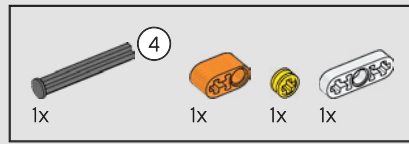

115

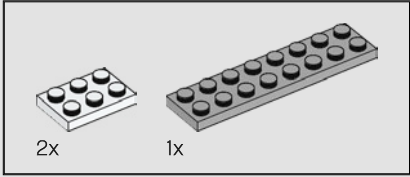

111

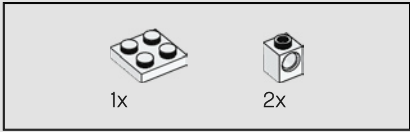
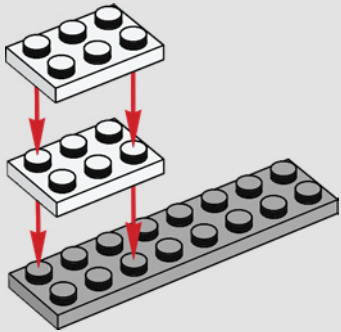

112

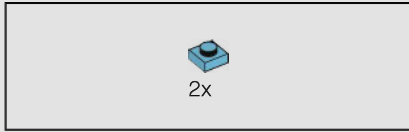
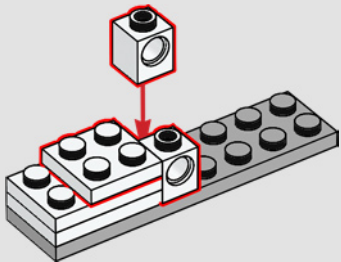

114

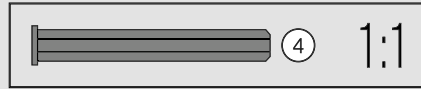
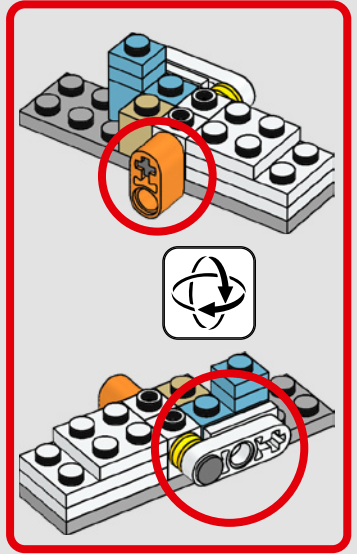
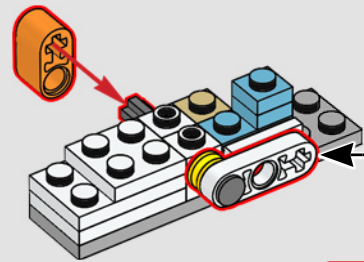
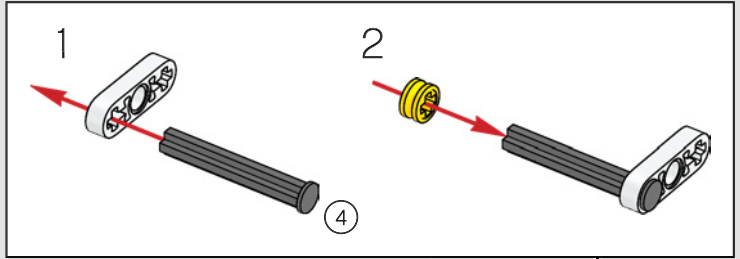
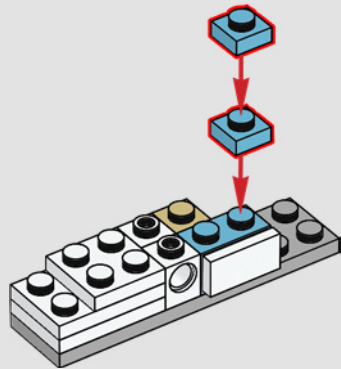

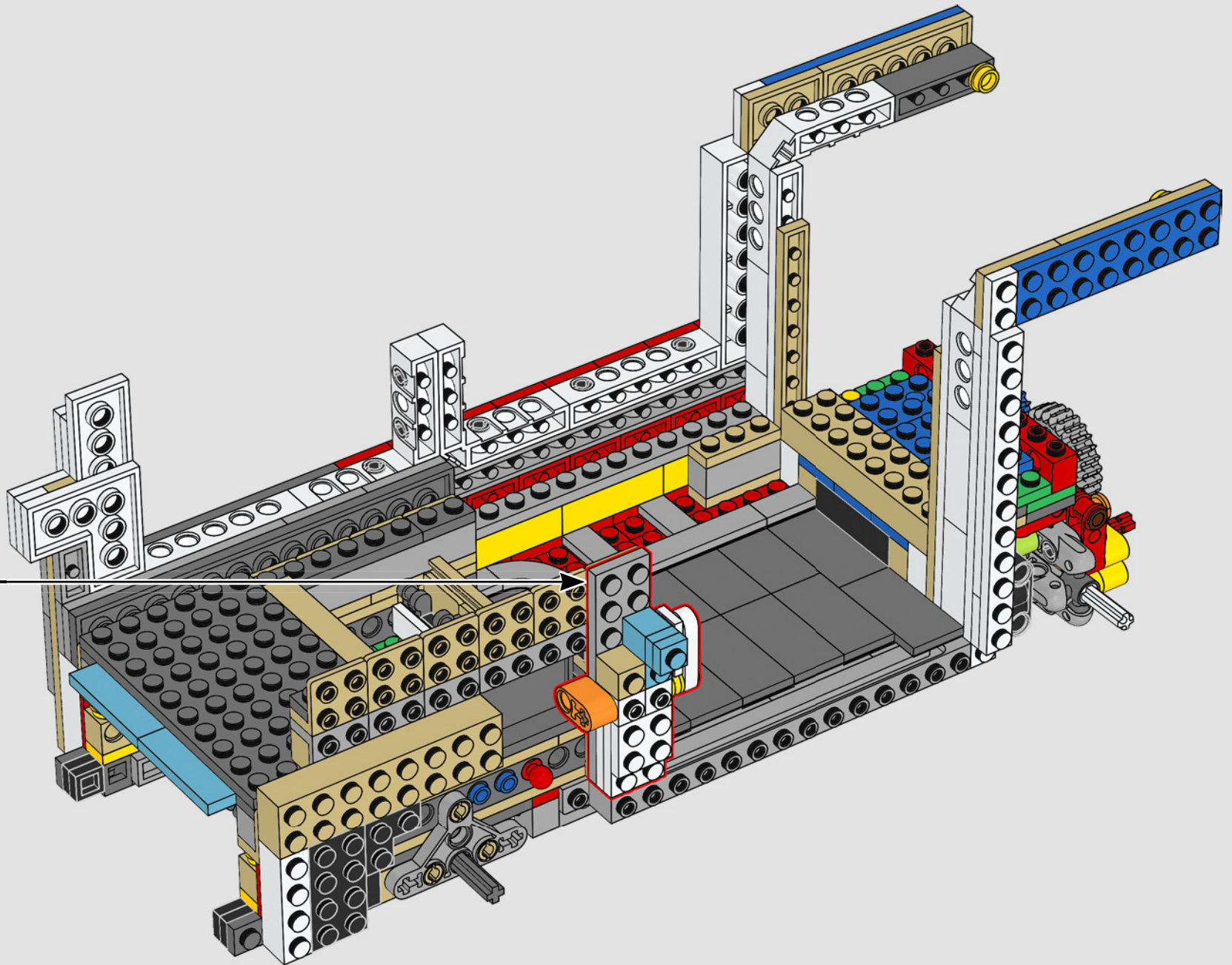

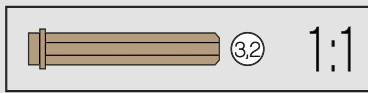
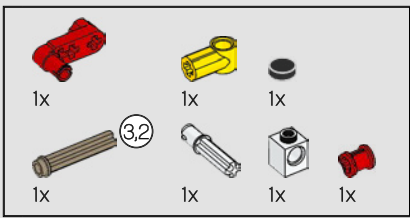

117

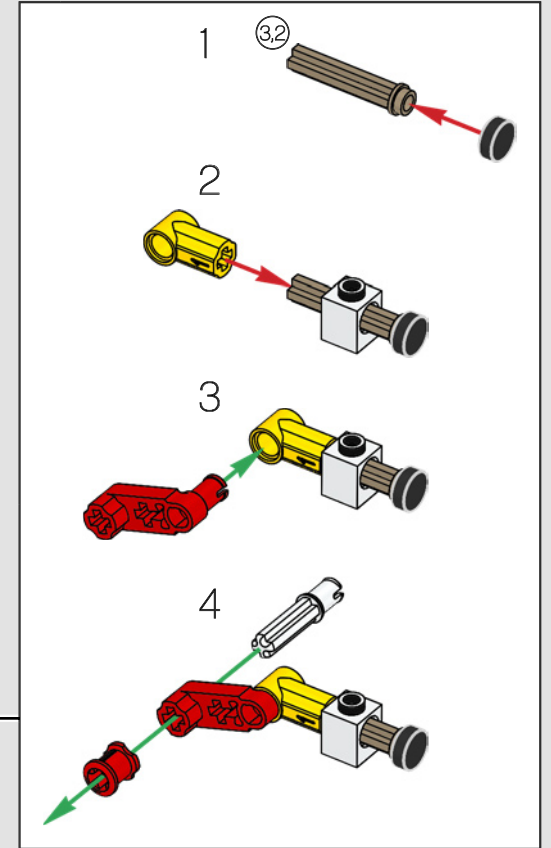
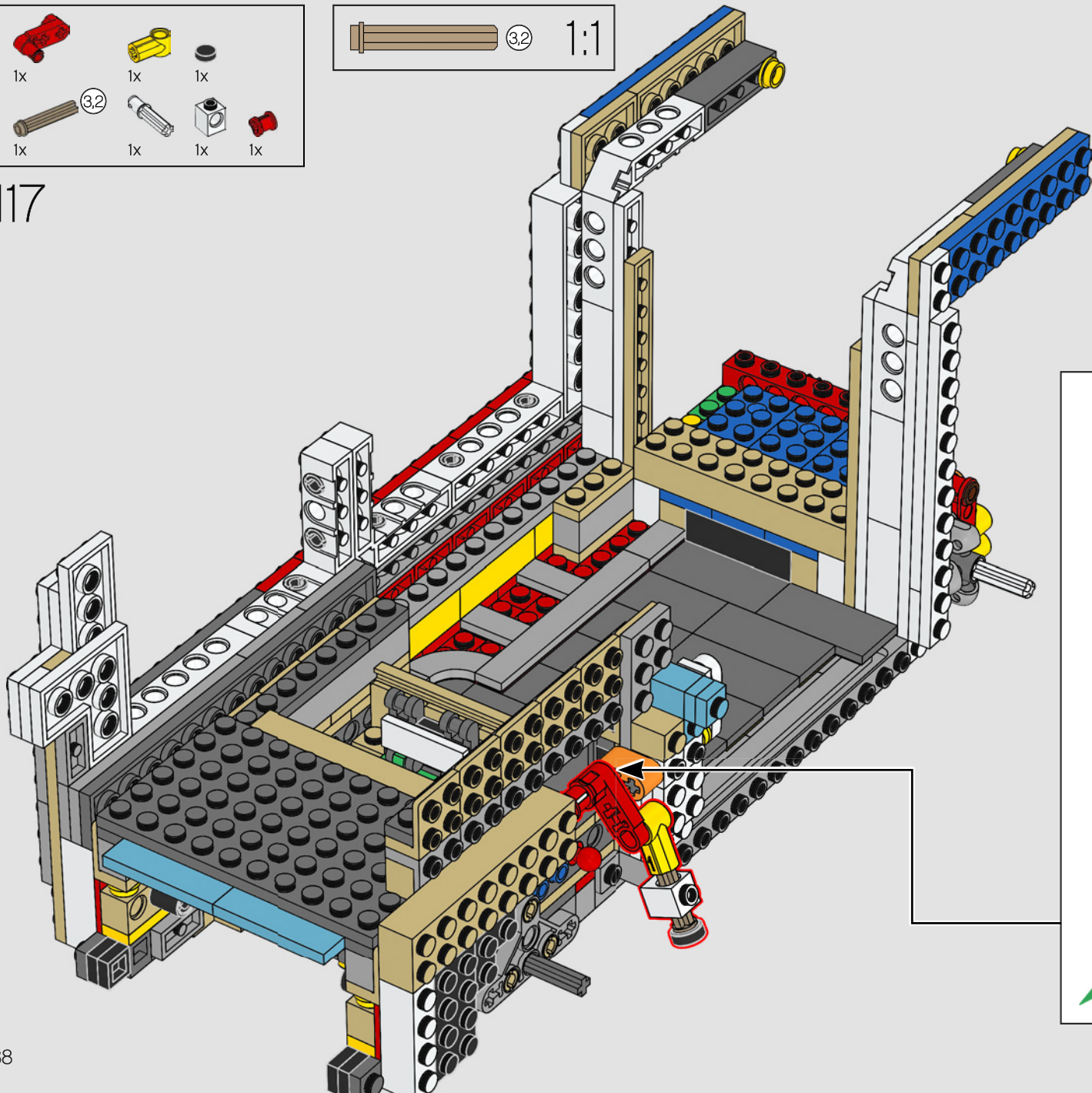

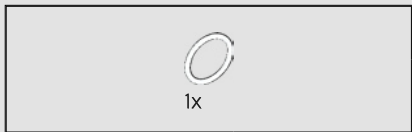

118

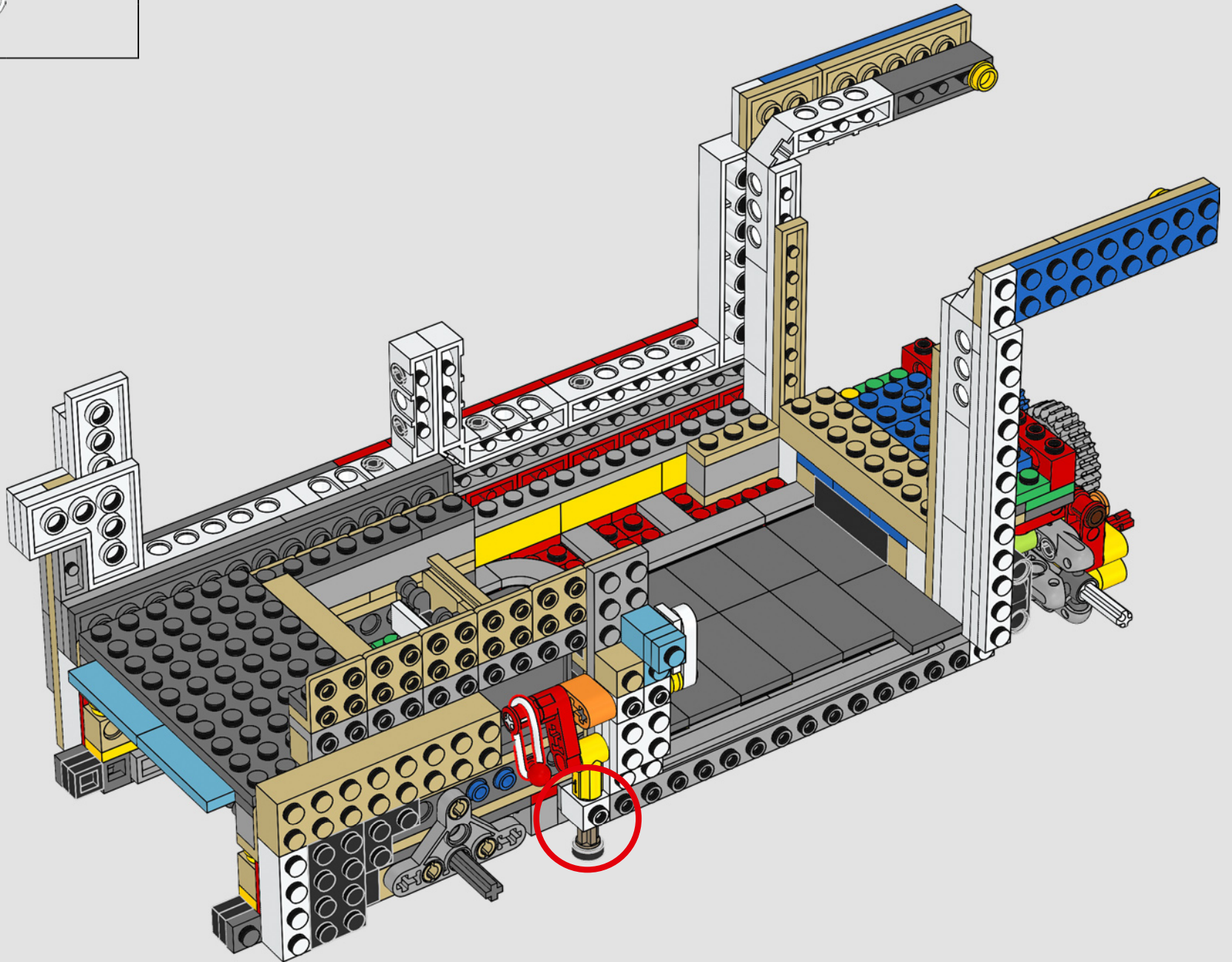

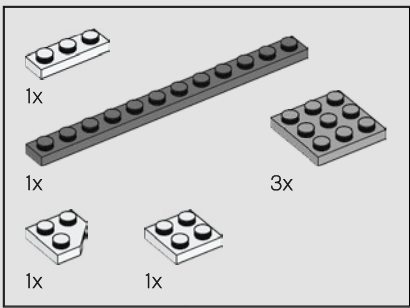

119

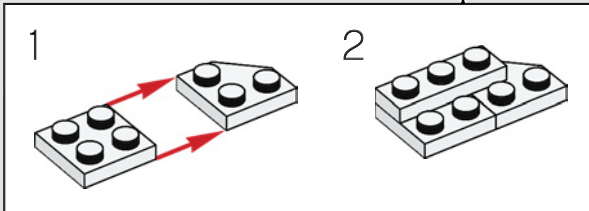
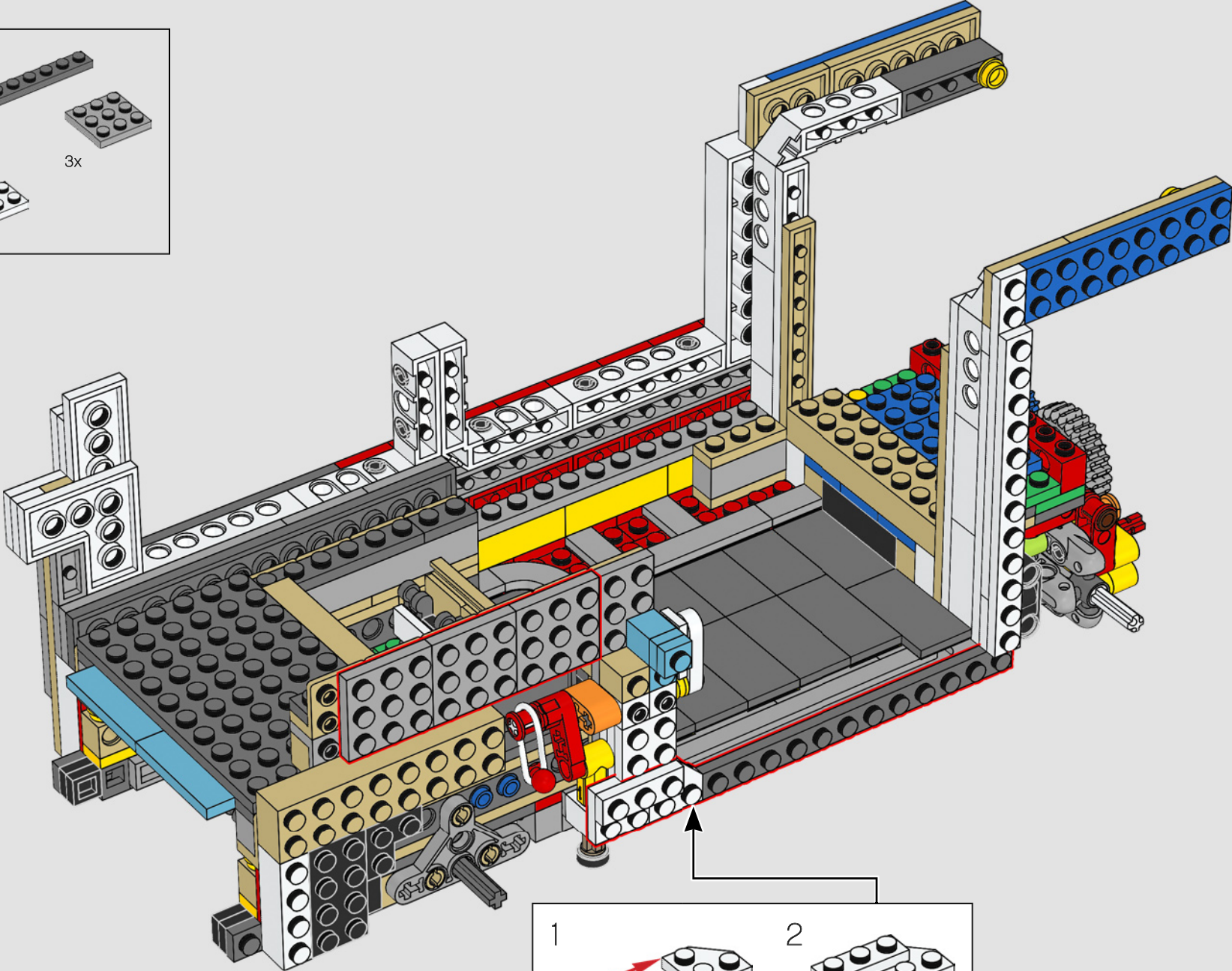

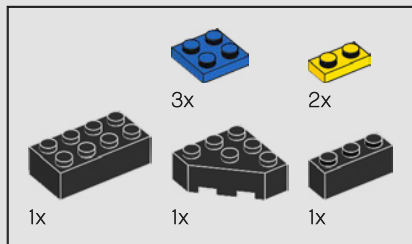

120

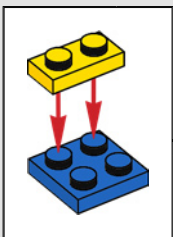
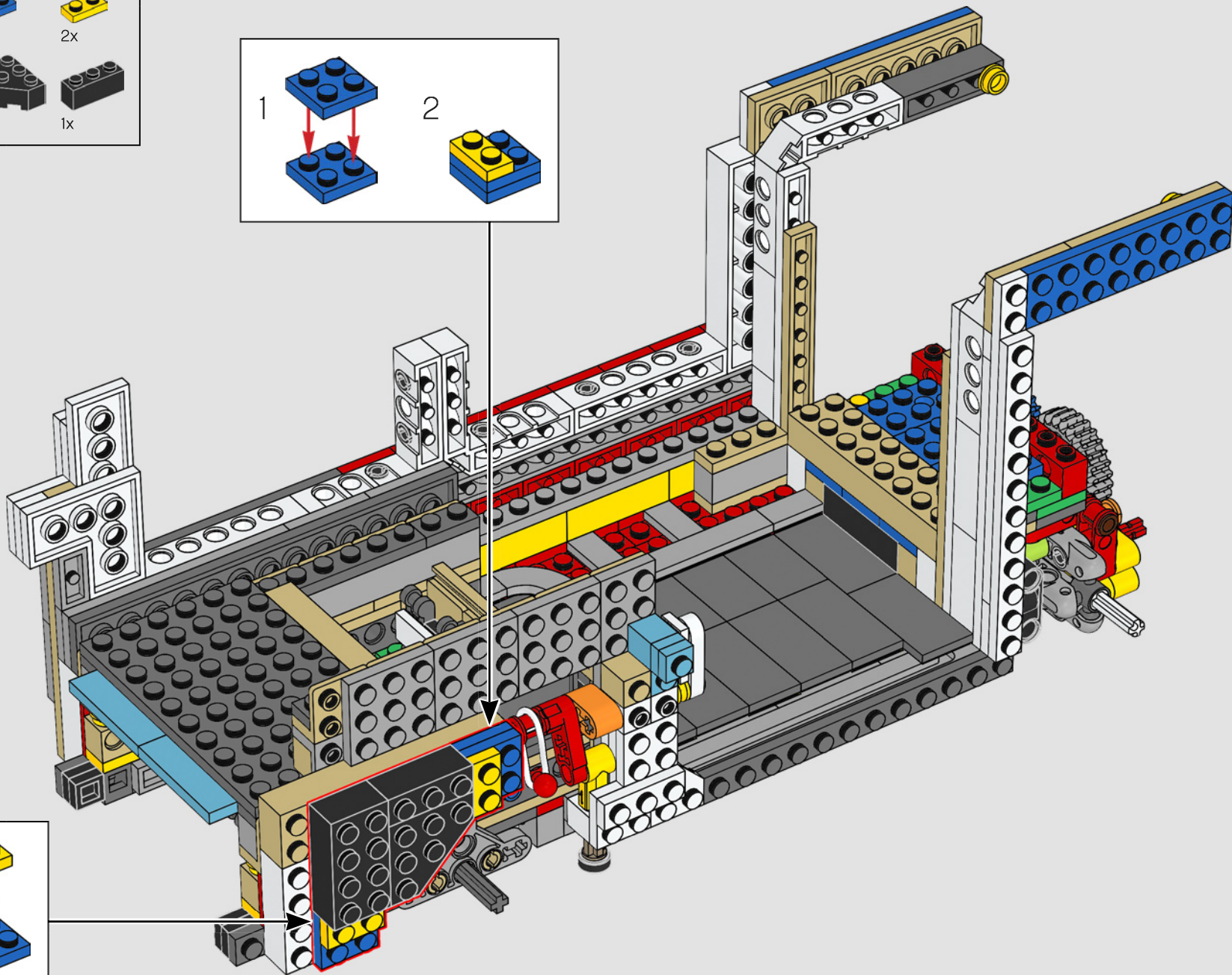
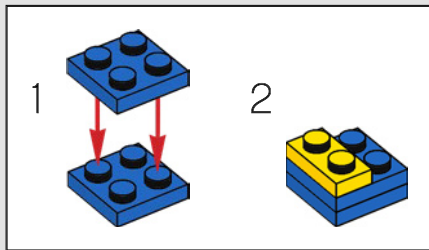

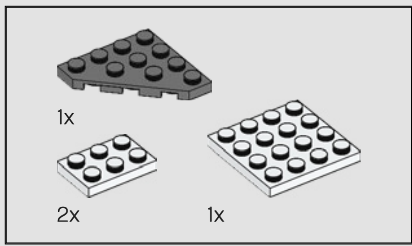

121

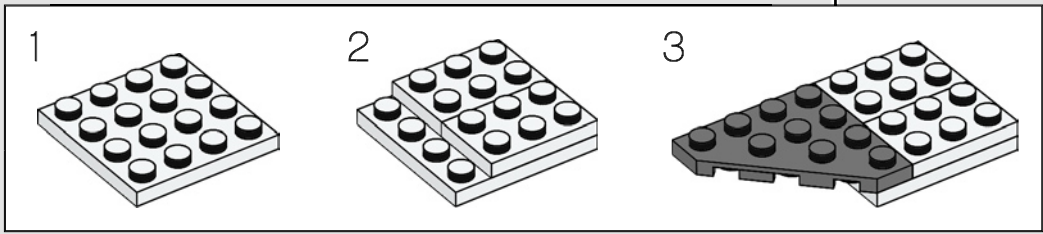
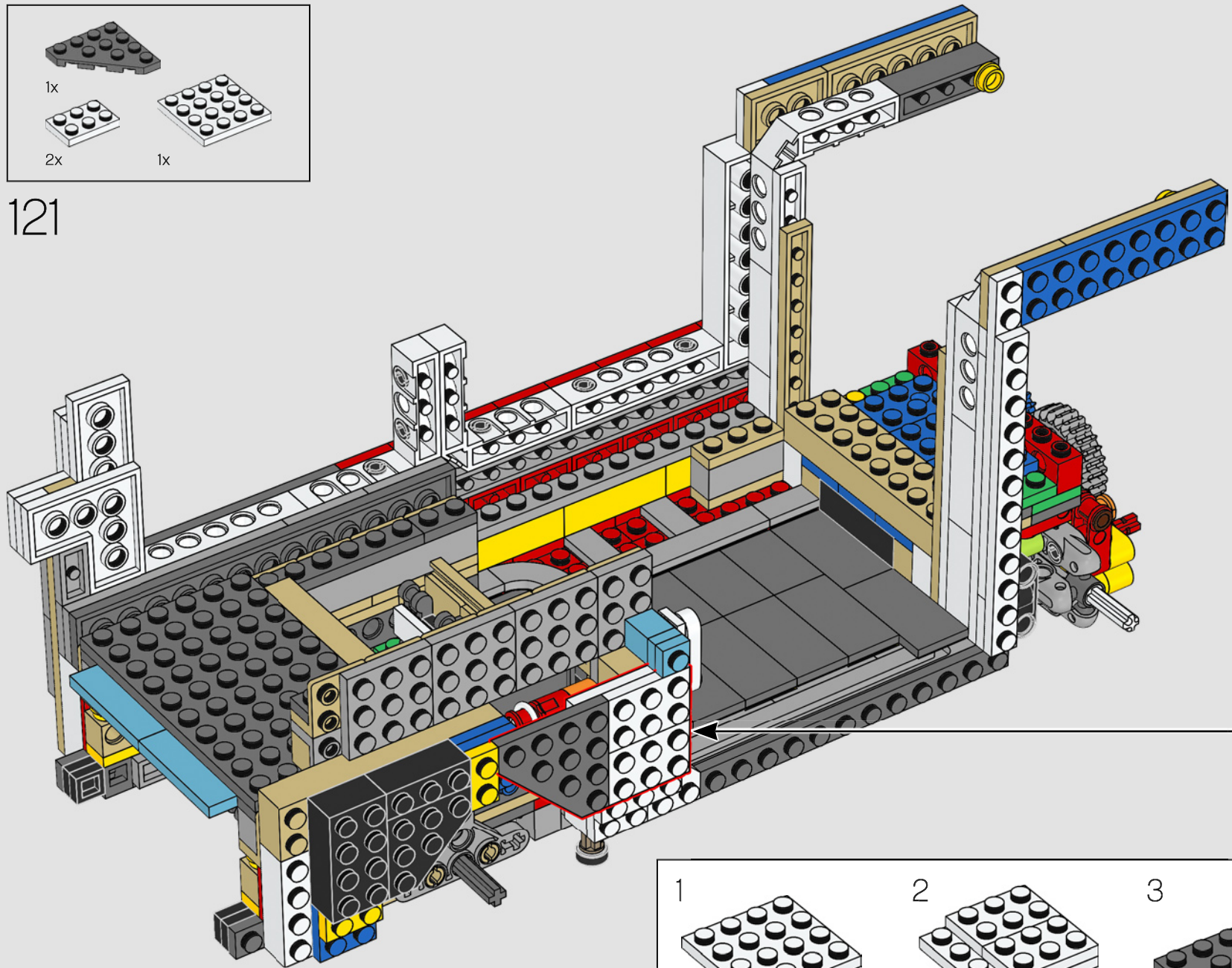

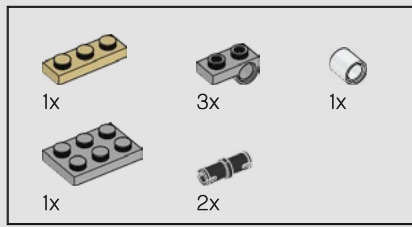

122

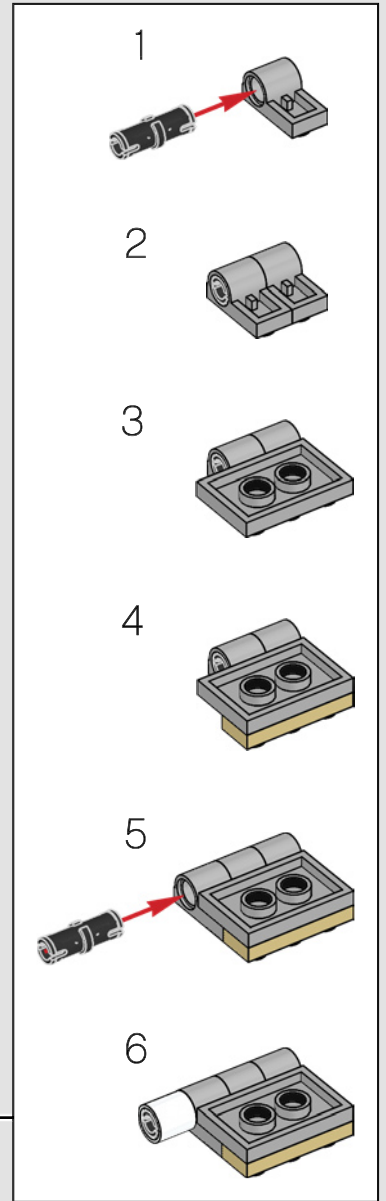
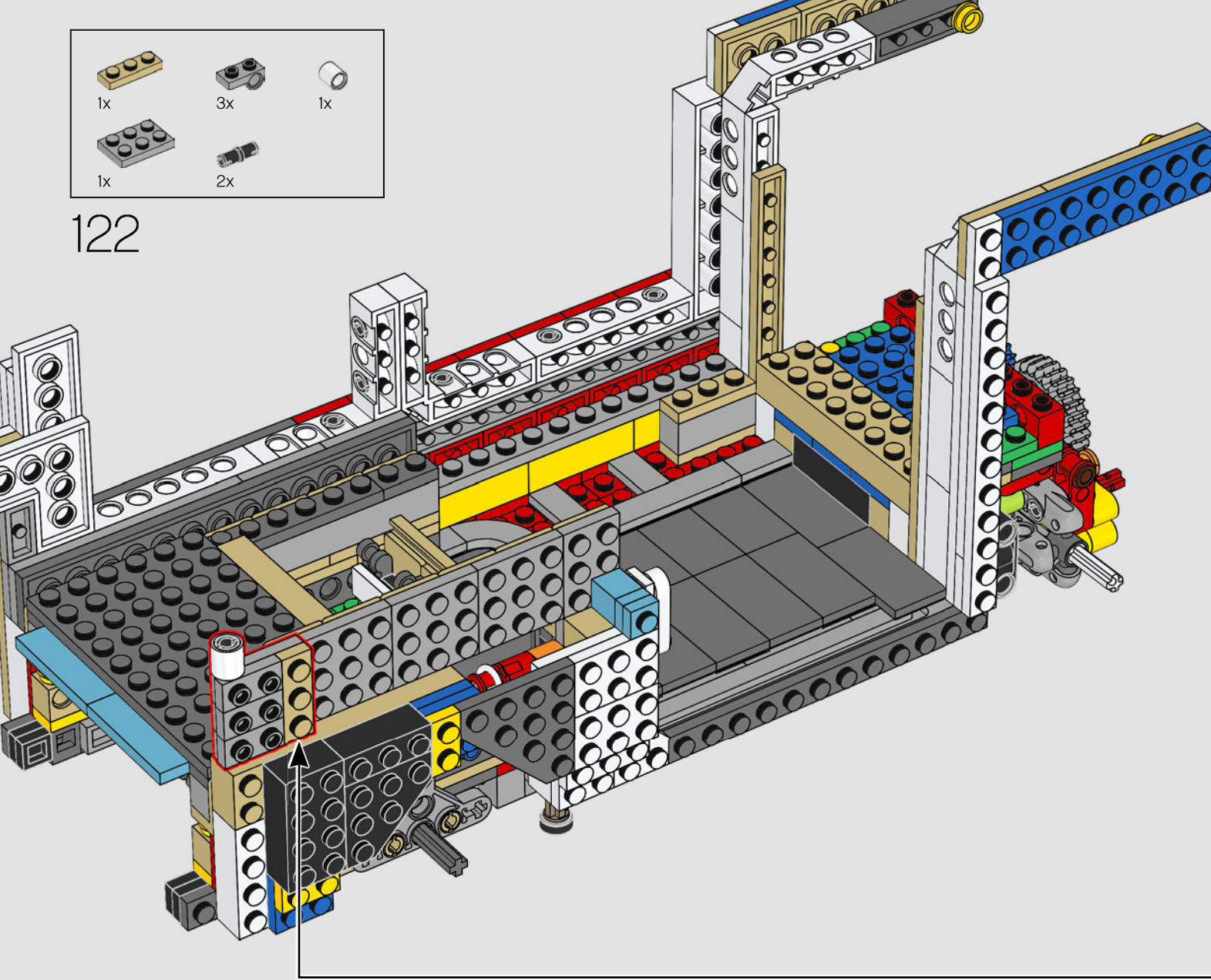

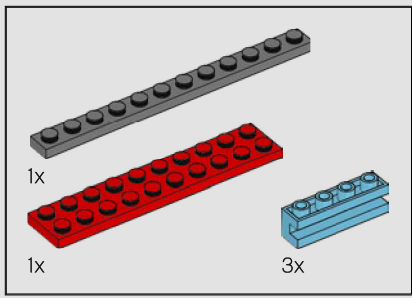

123

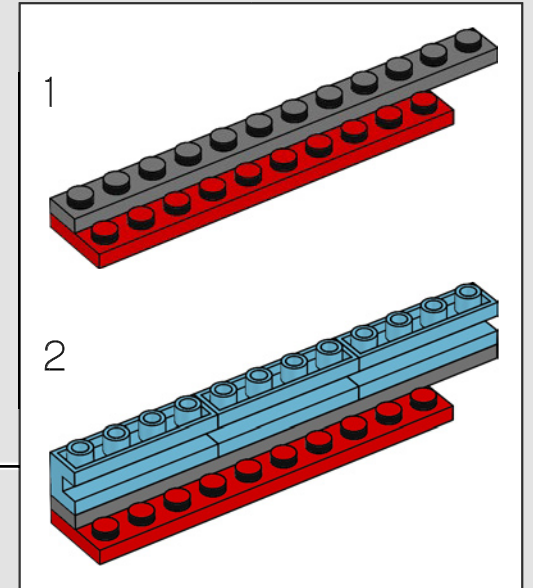
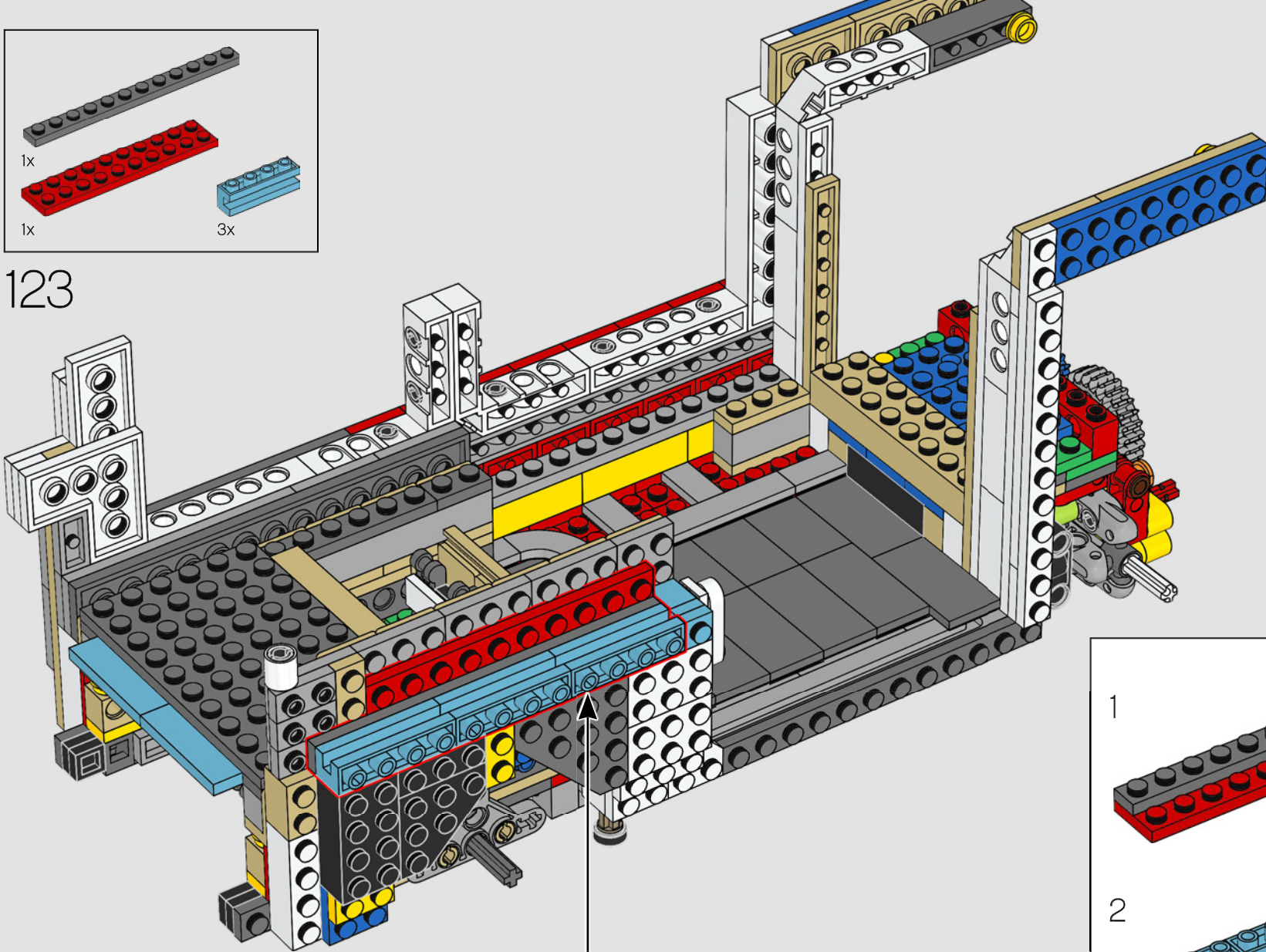

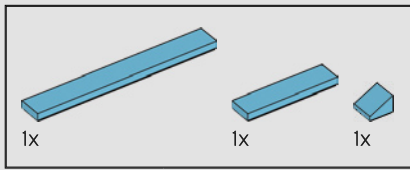

124

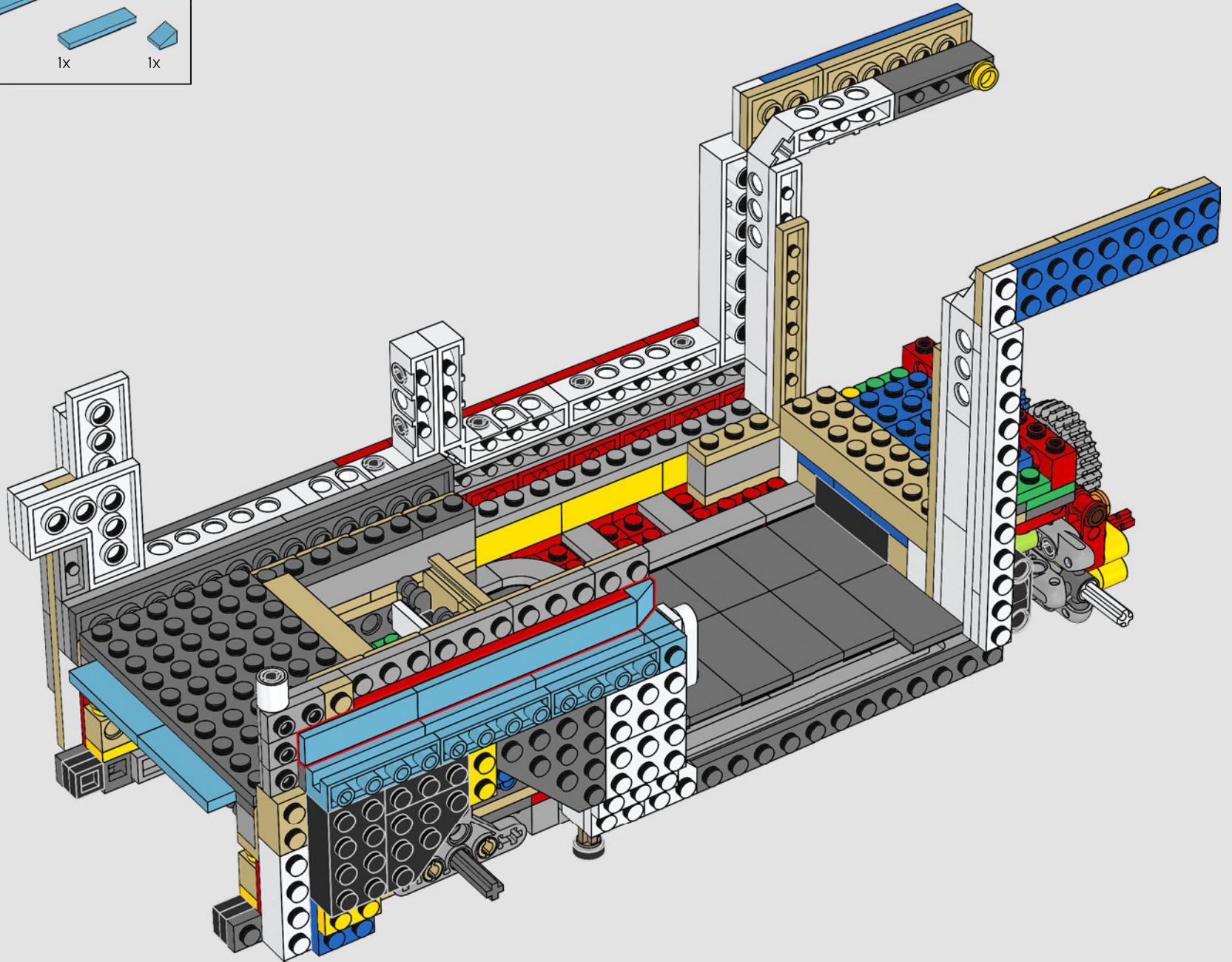

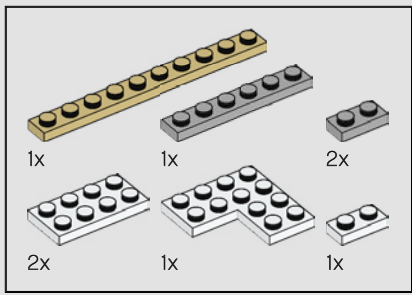

125

1

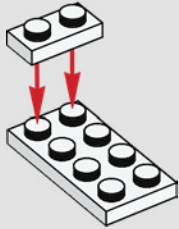

2

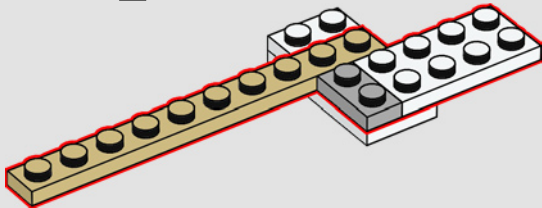

3

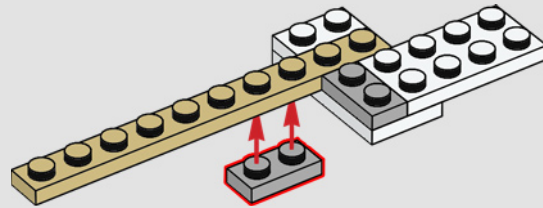

4

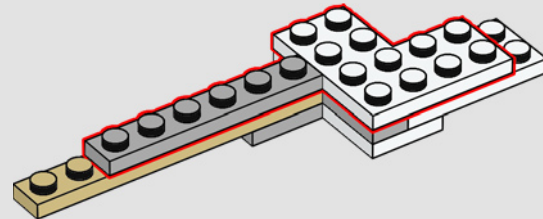

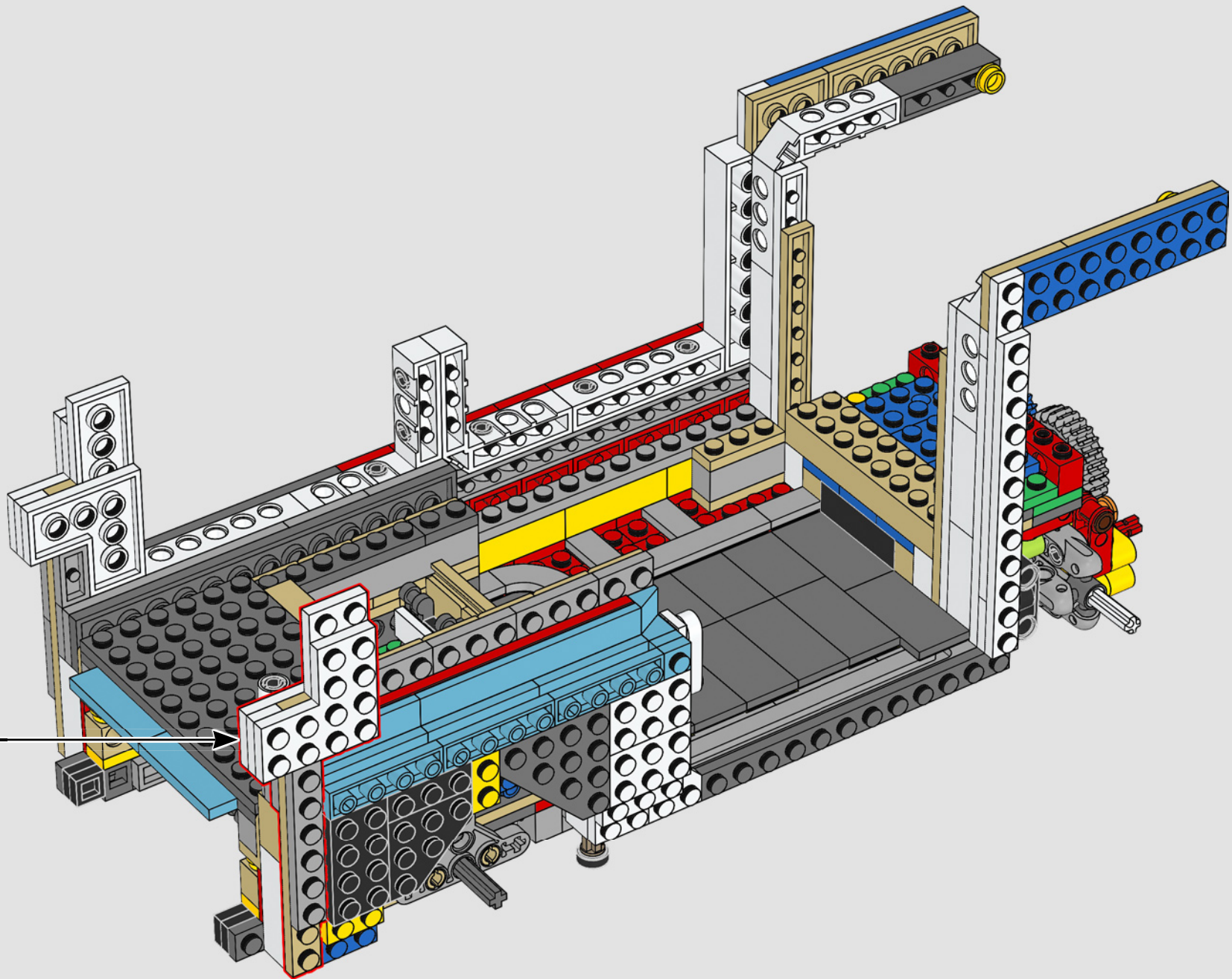

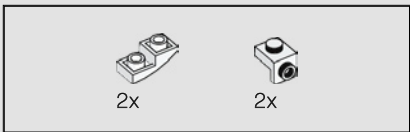

126

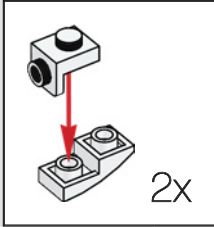
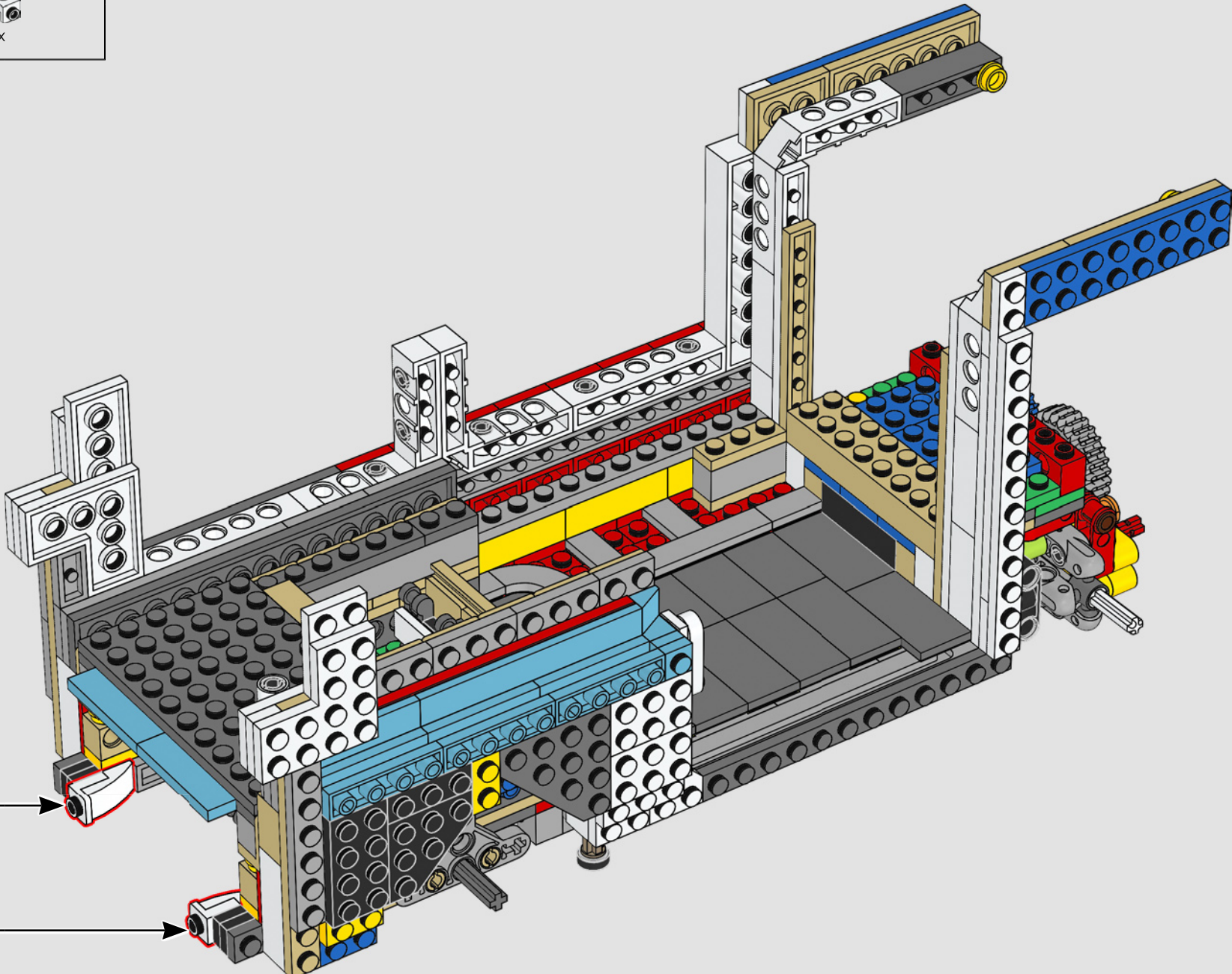

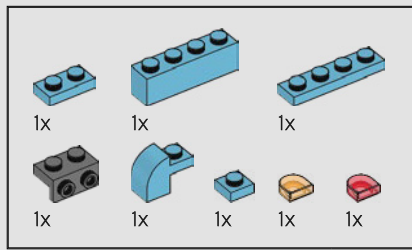

127

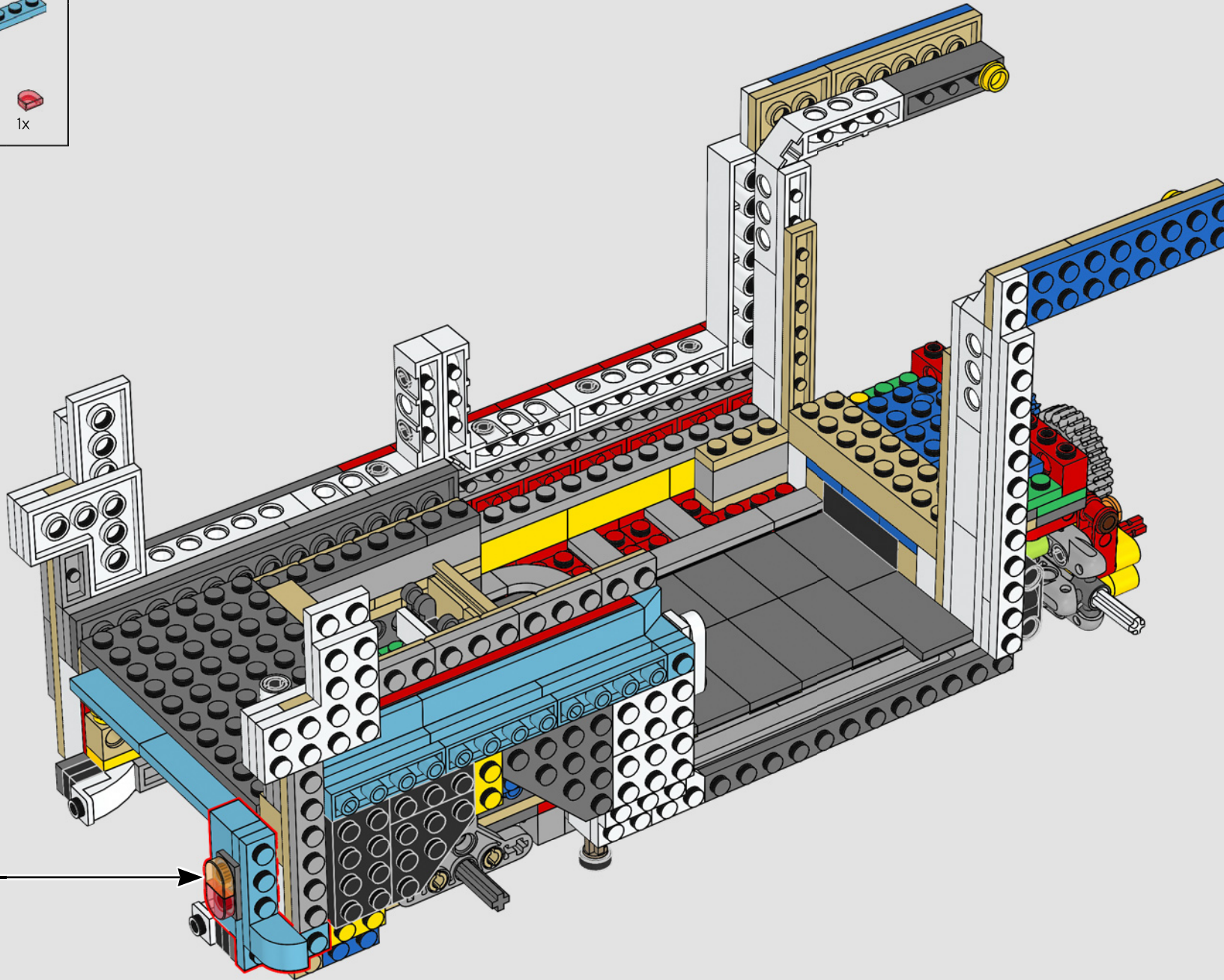
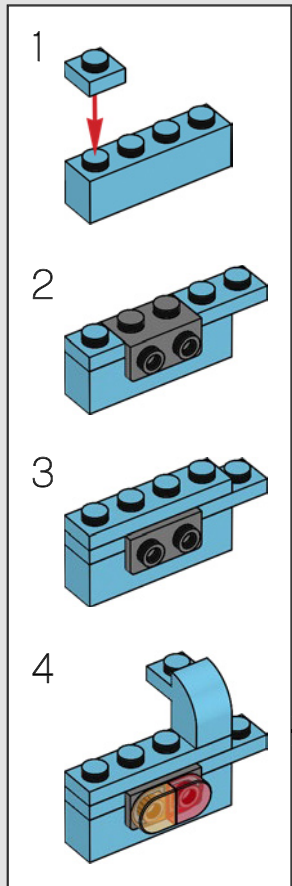

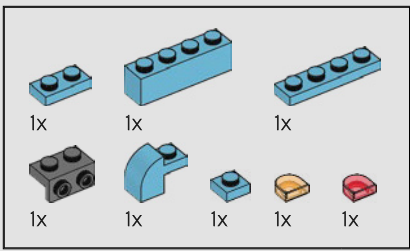

128

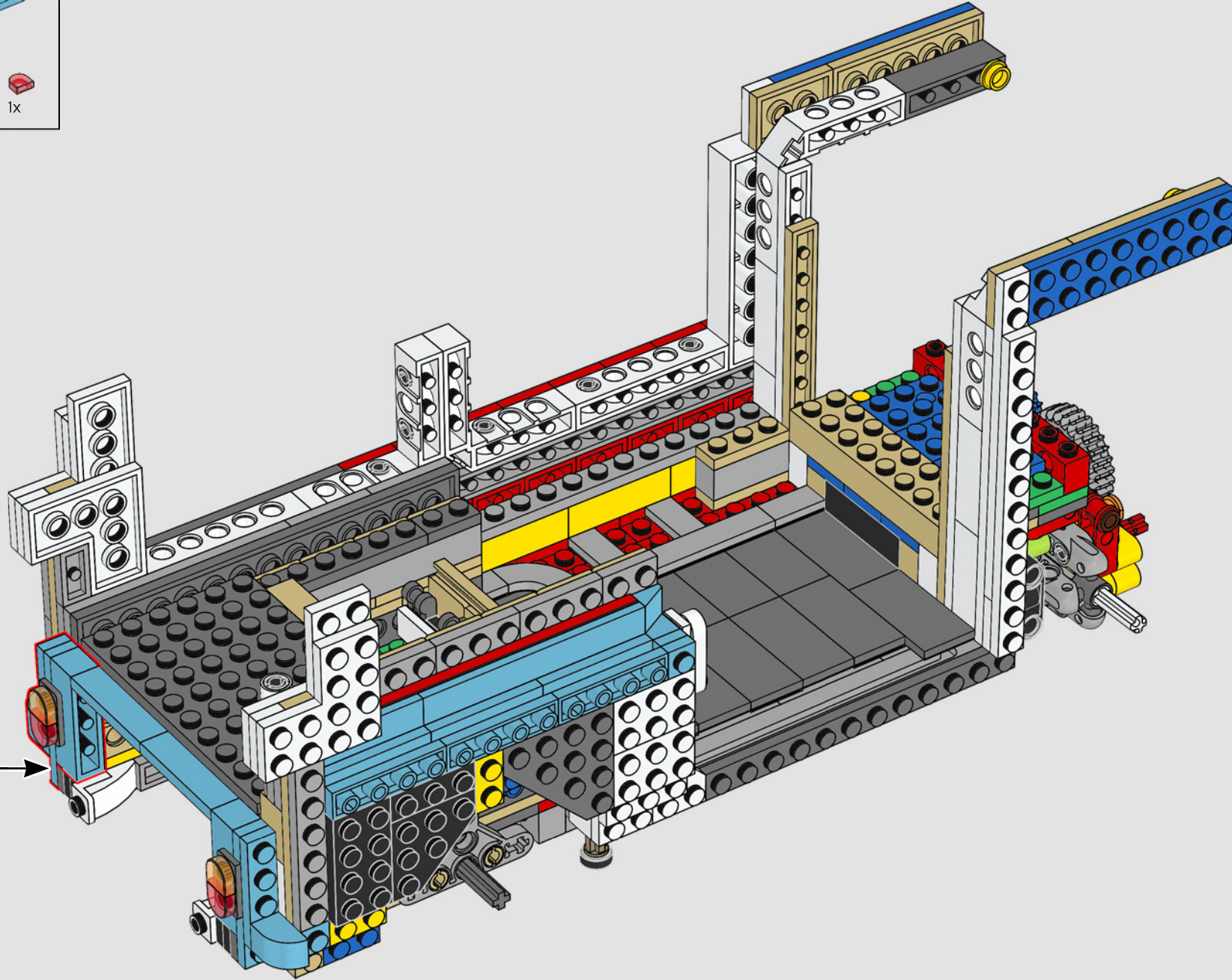
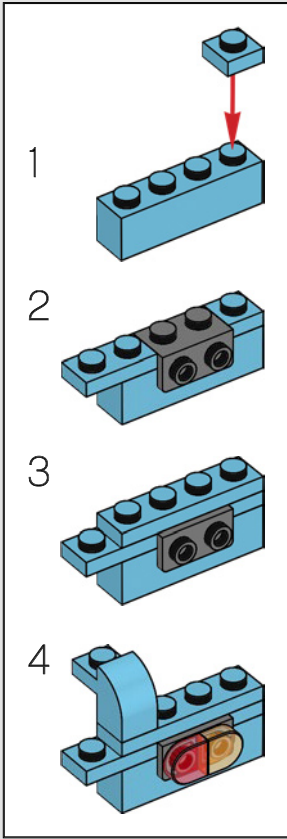

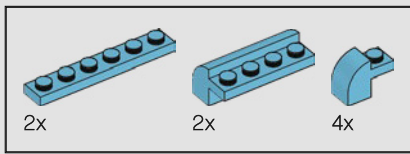

129

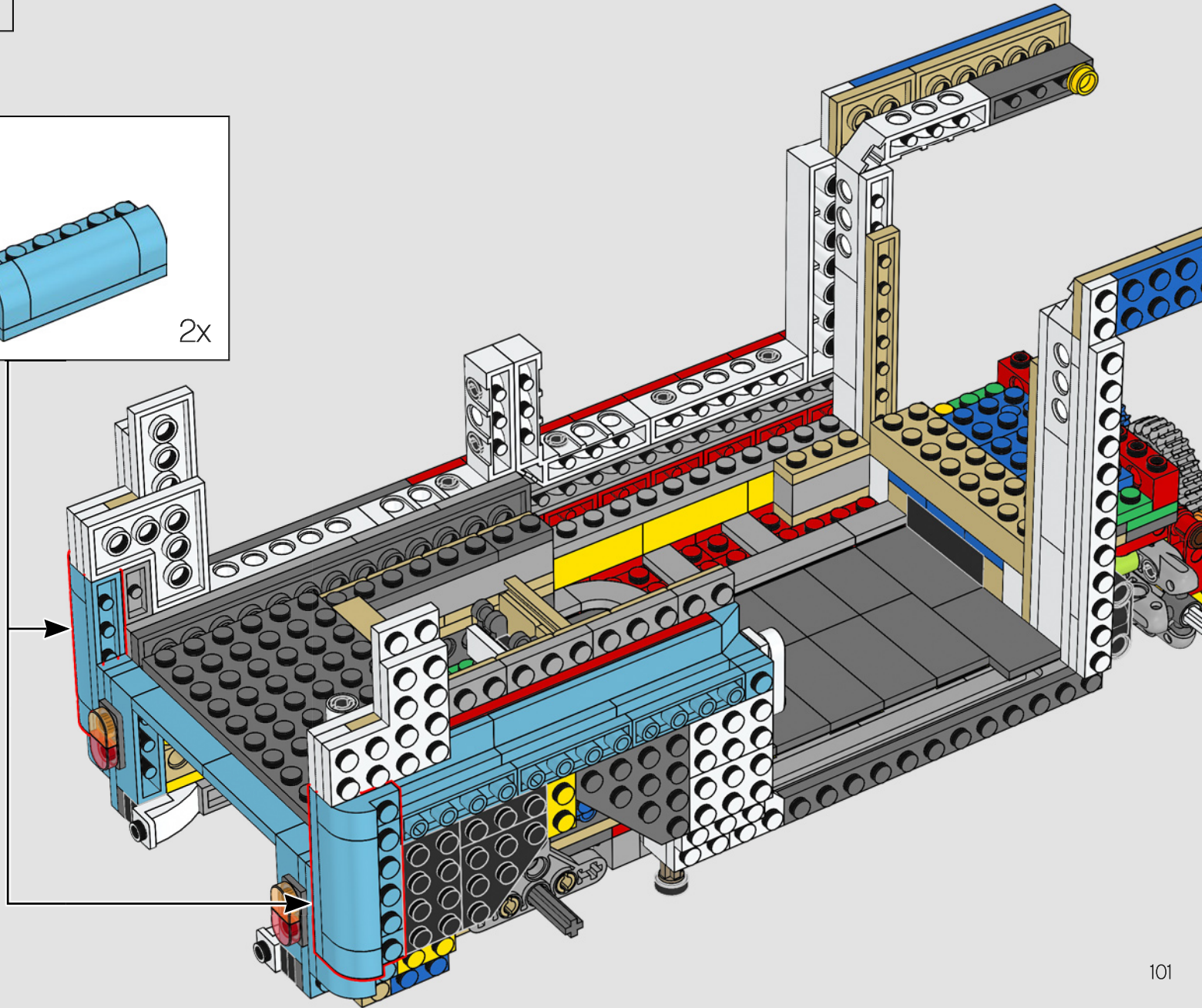
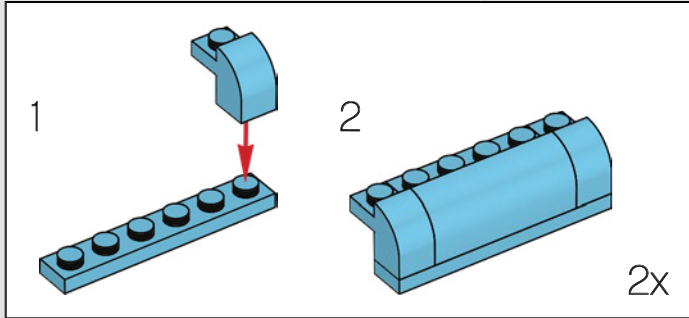

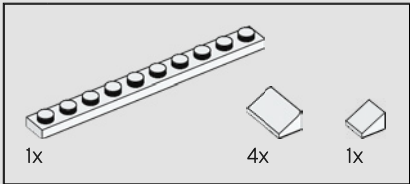
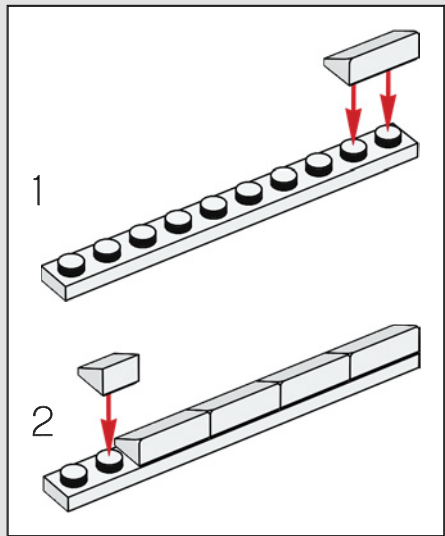
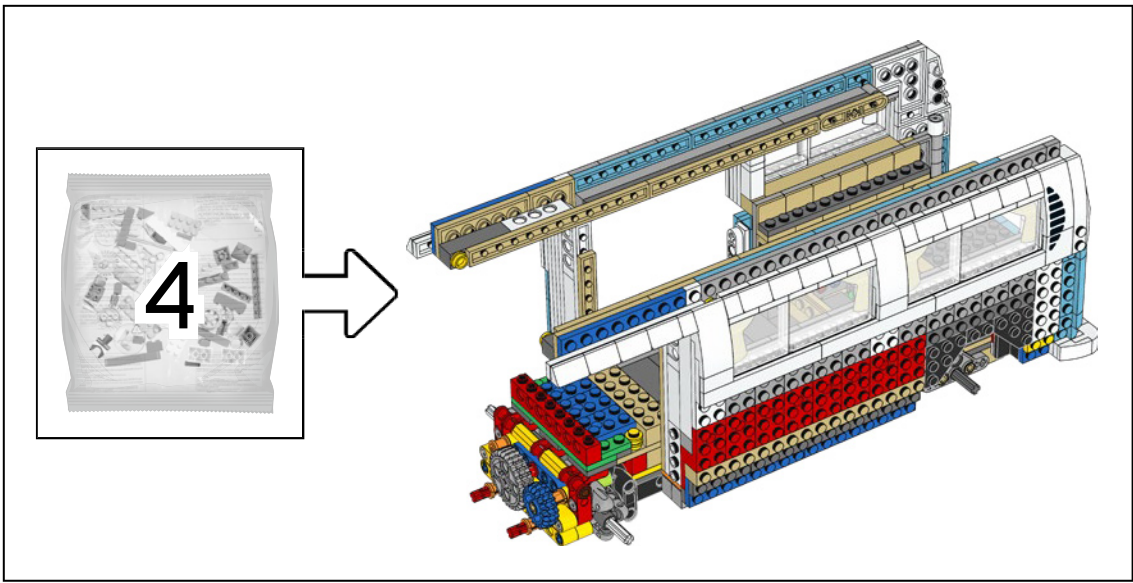

130

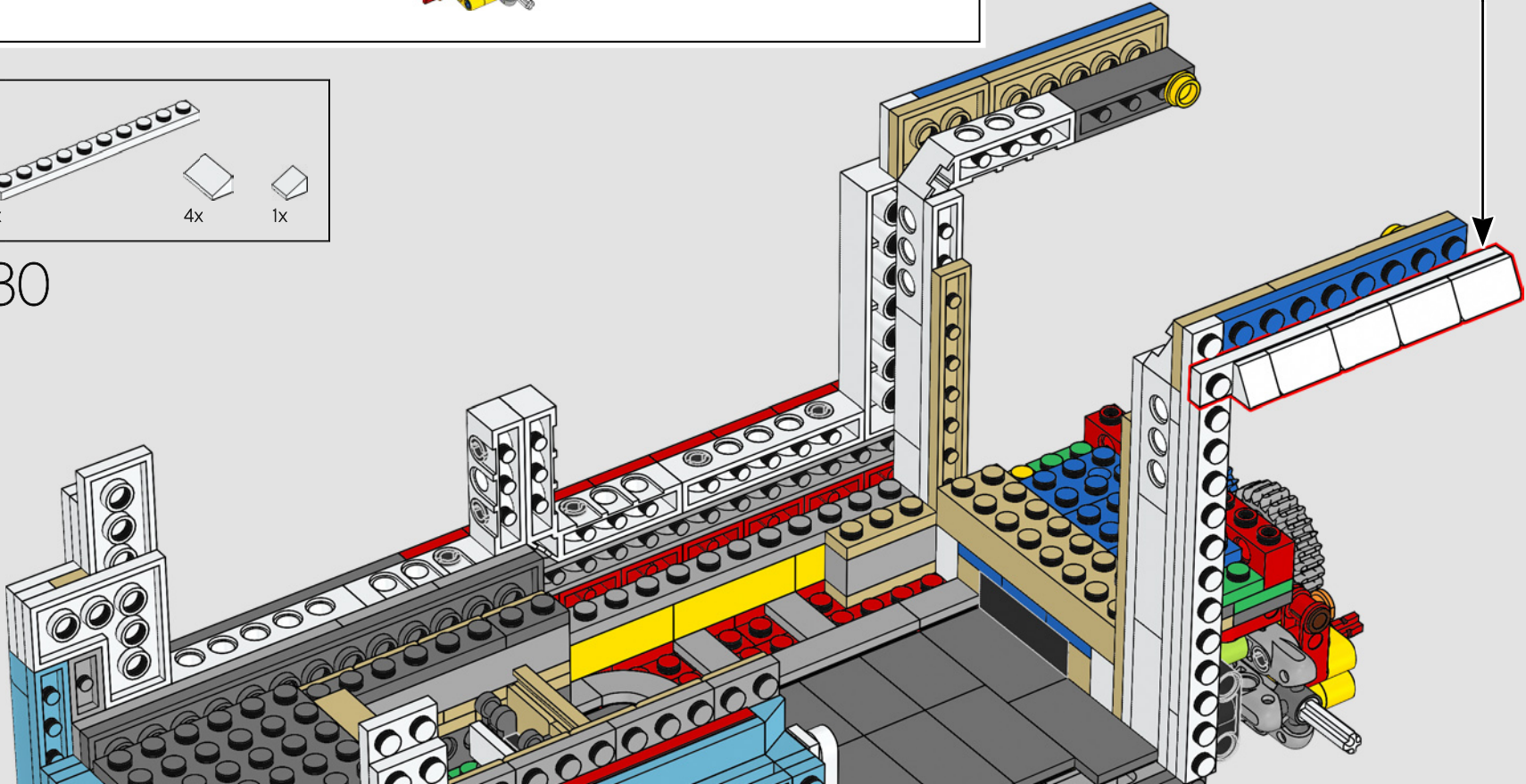

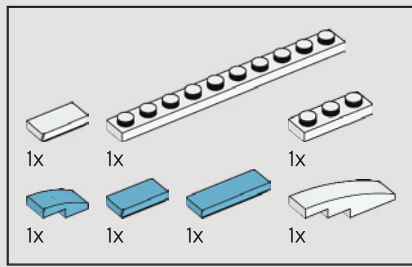

131

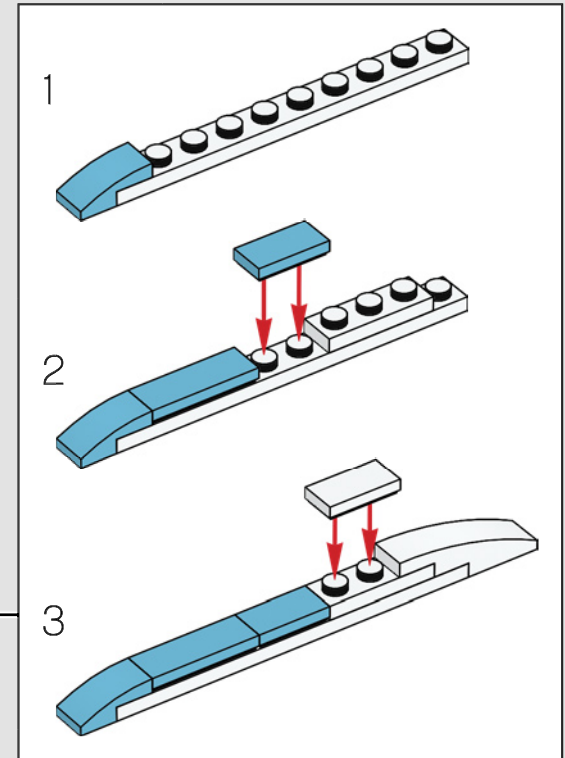
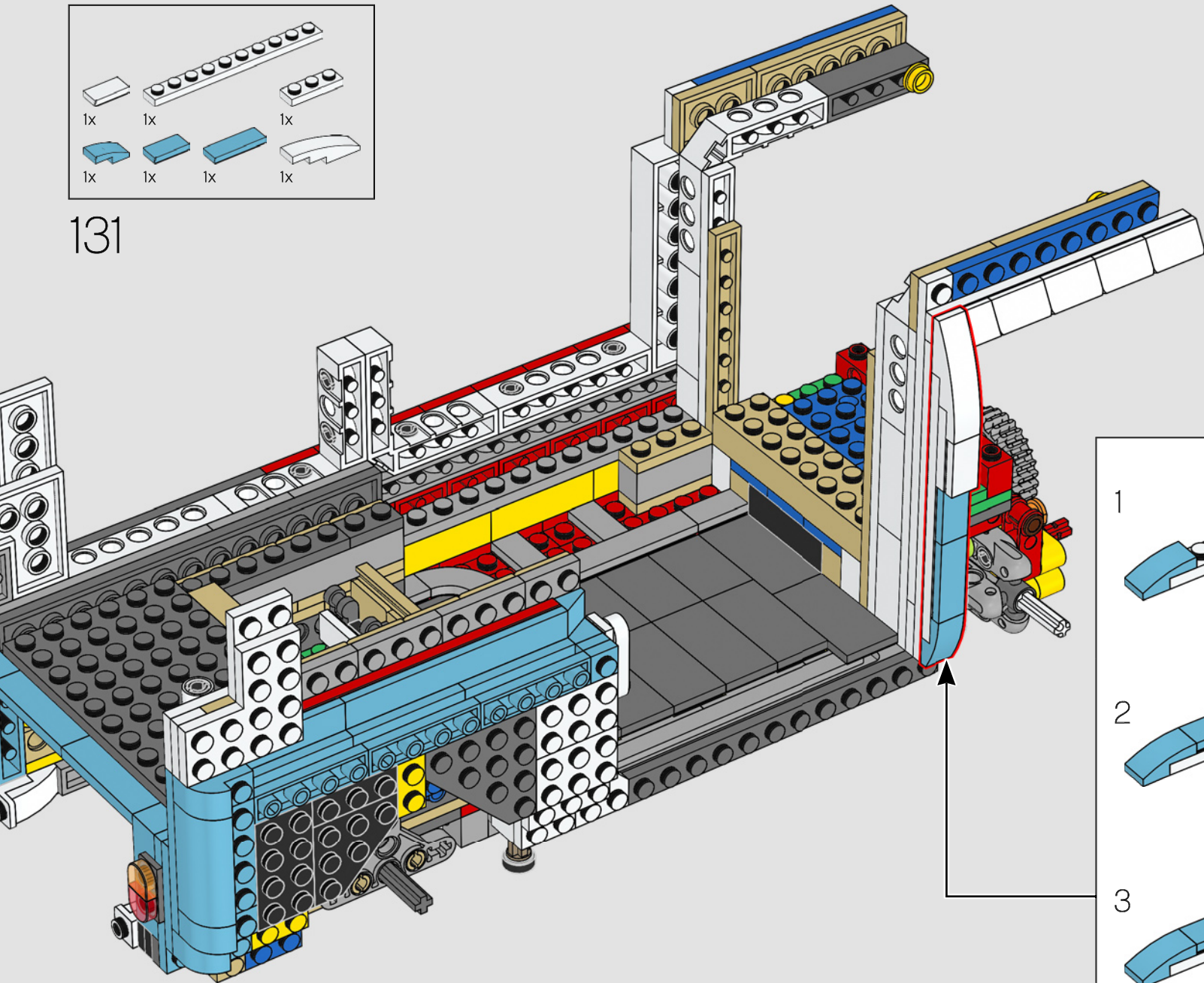

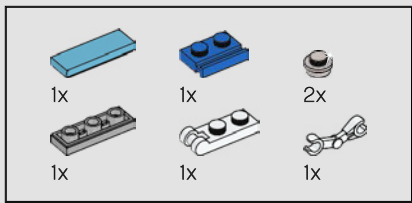

132

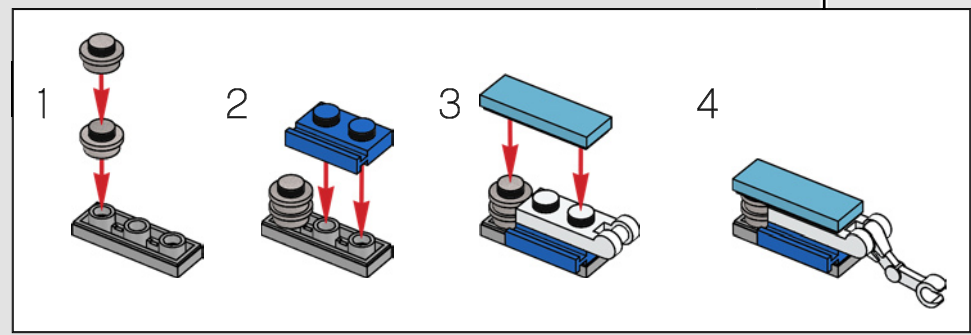
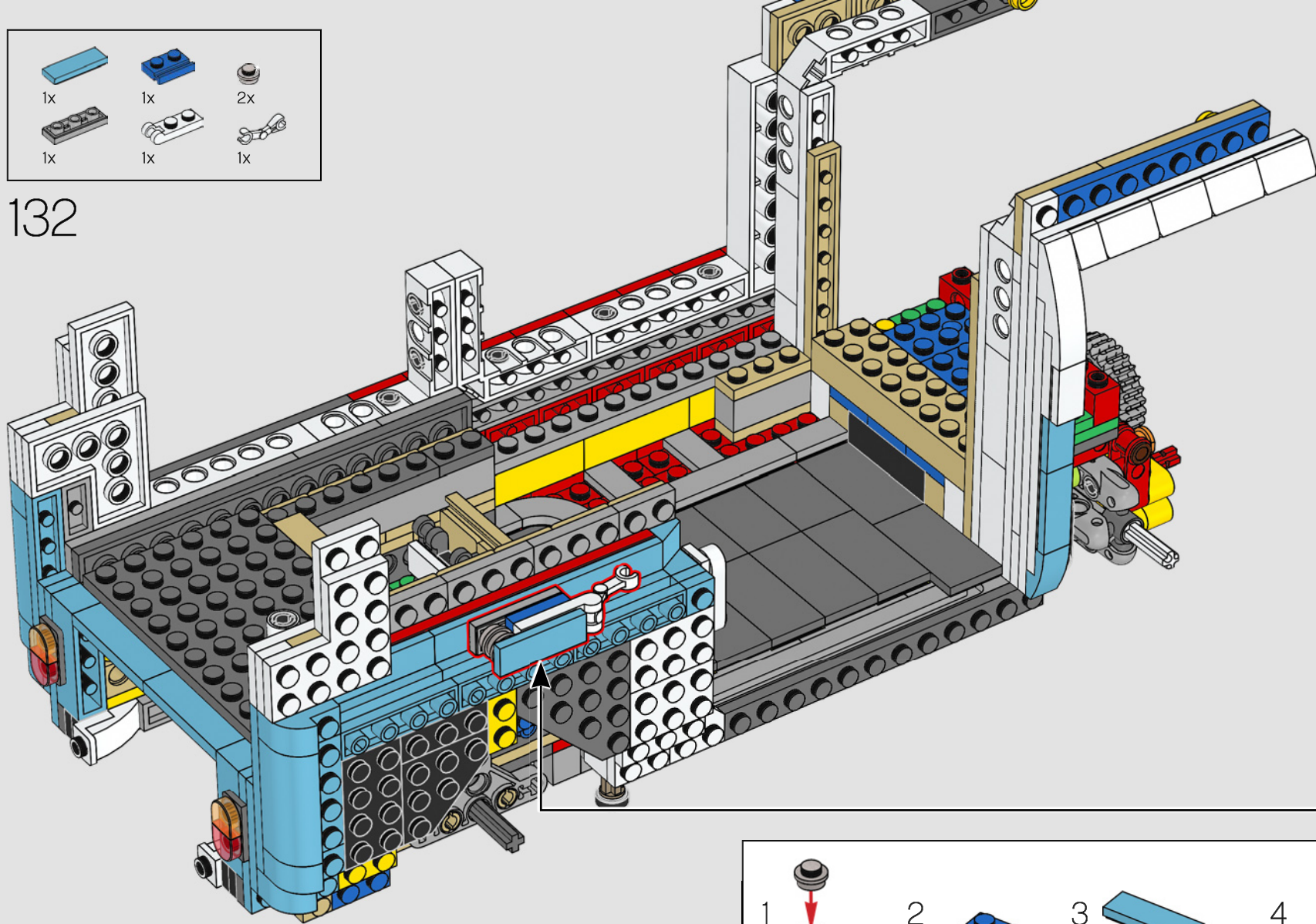

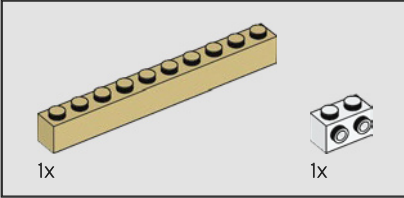
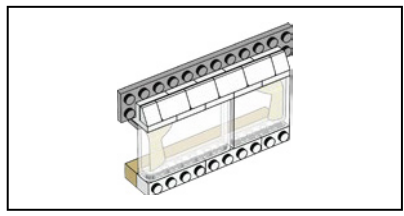

133

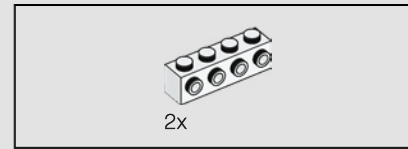
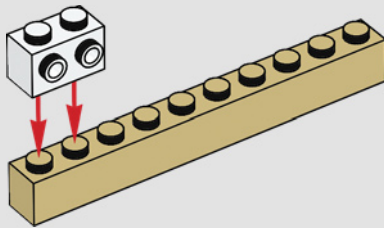

134

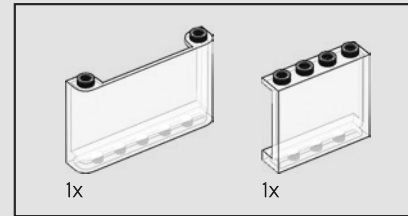
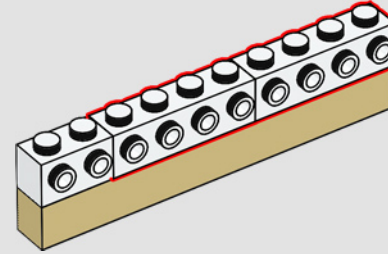

135

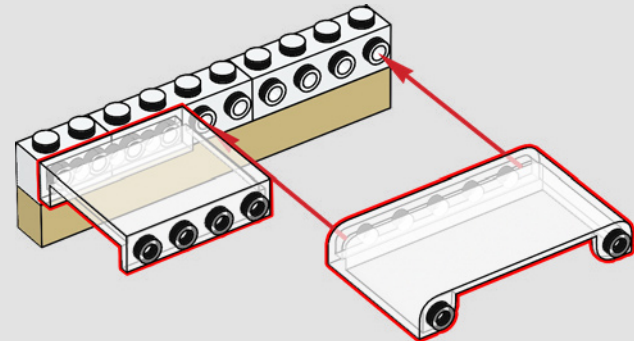

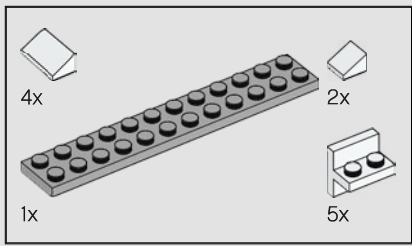

136

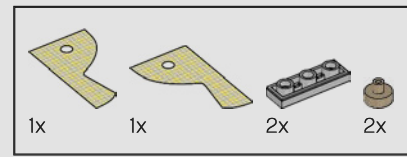
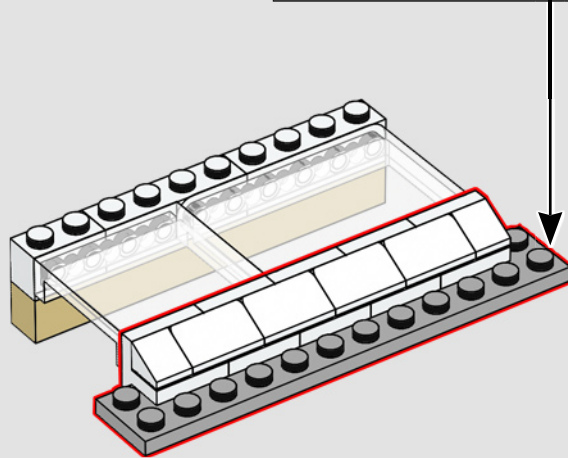
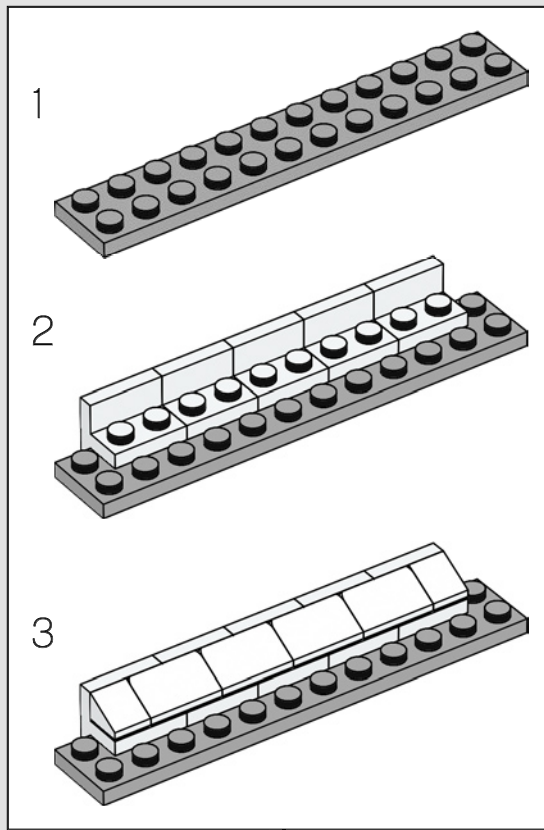

137

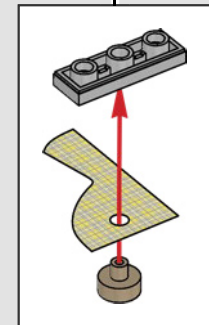
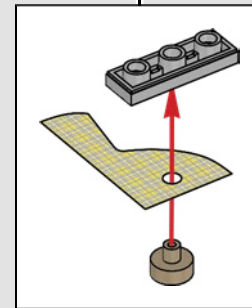
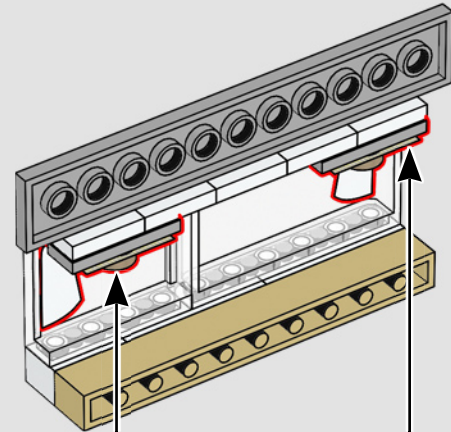
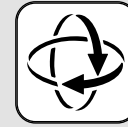

138

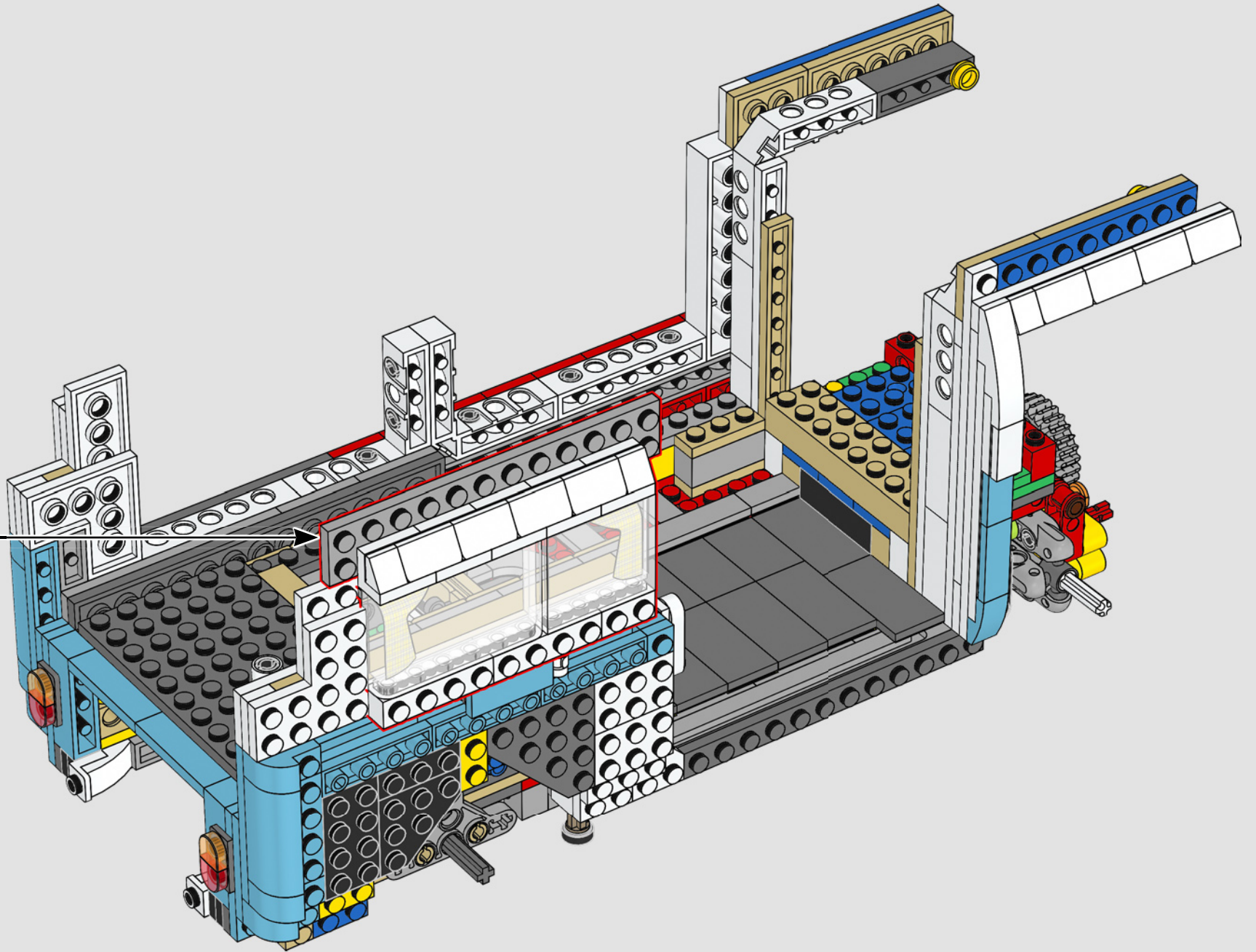

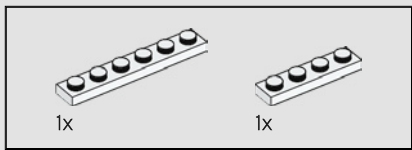

139

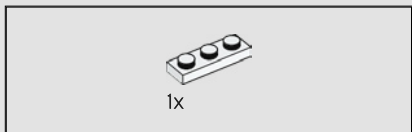
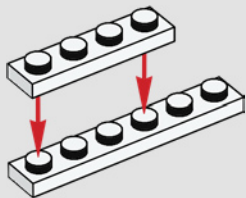

140

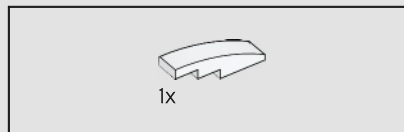
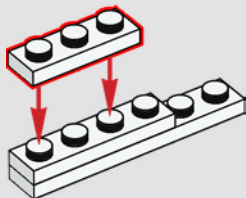

141

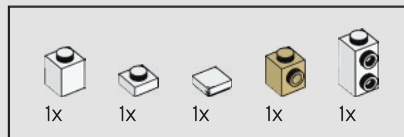
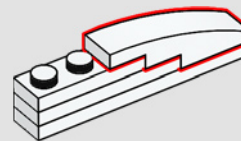

142

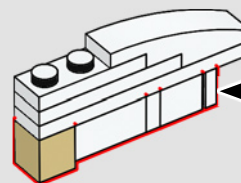
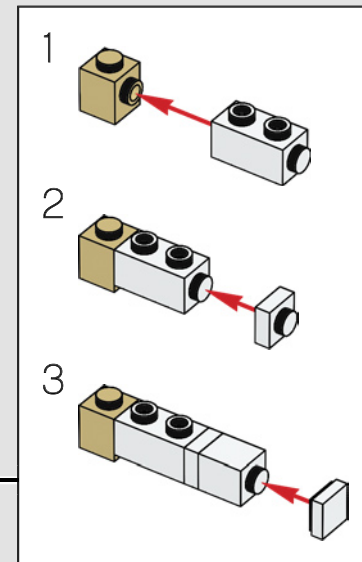

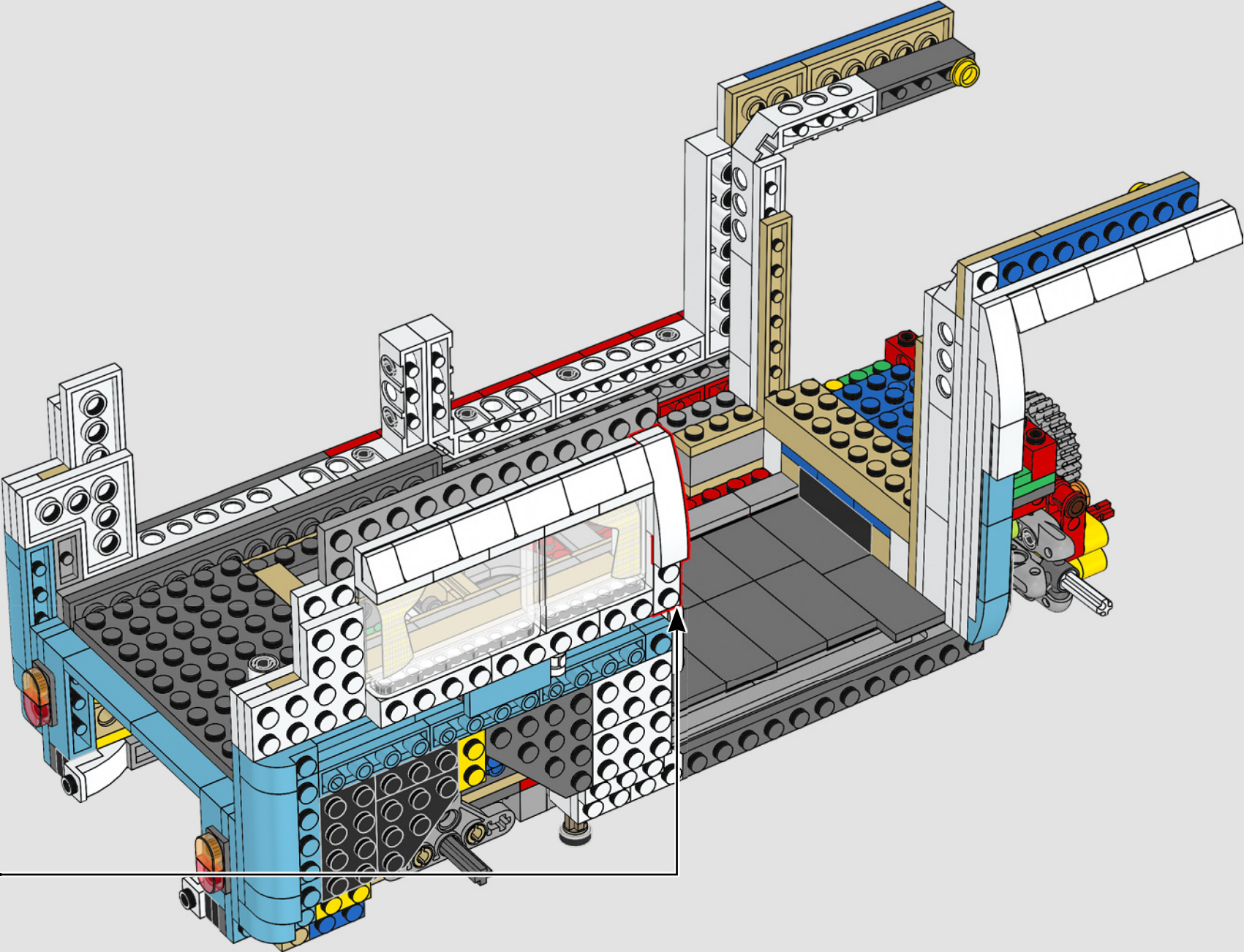

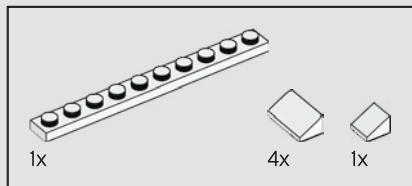

145

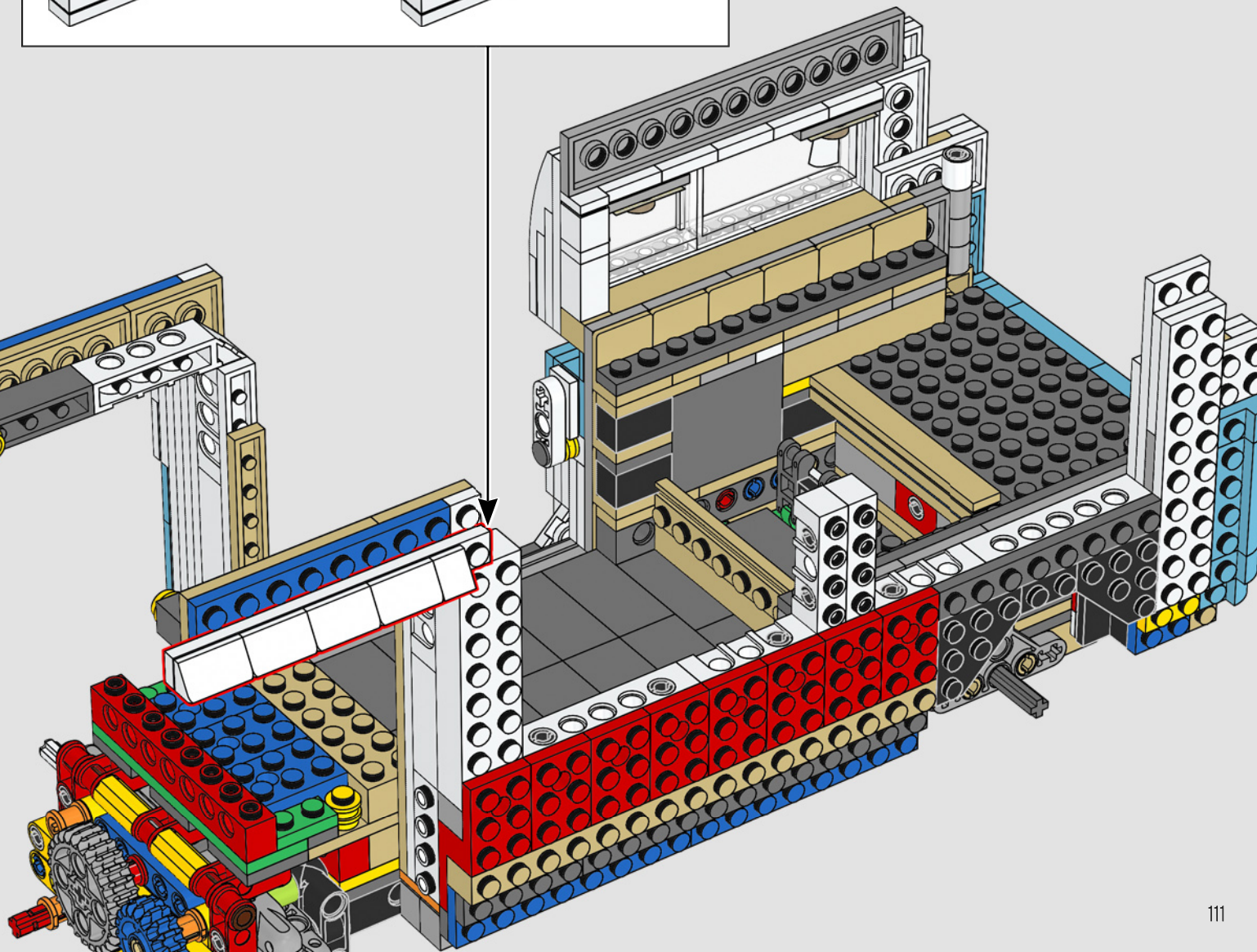
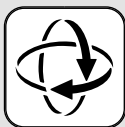
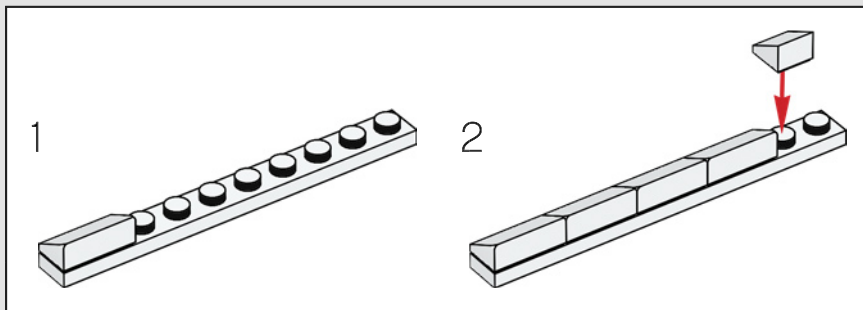

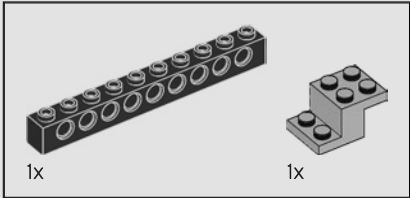
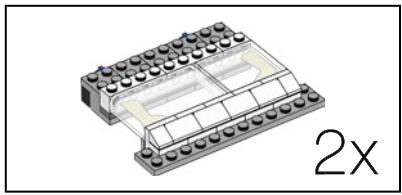

146

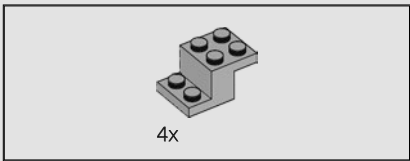
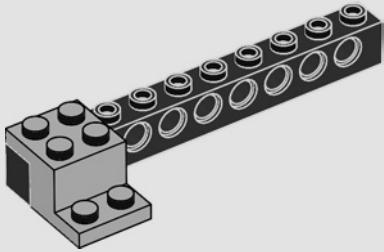

147

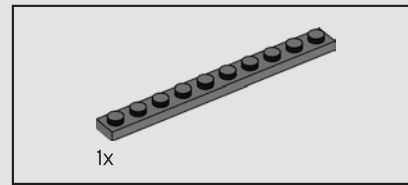
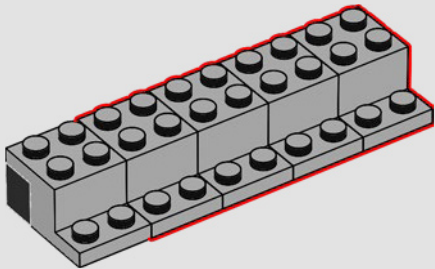

148

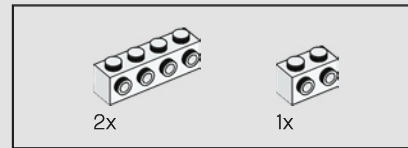
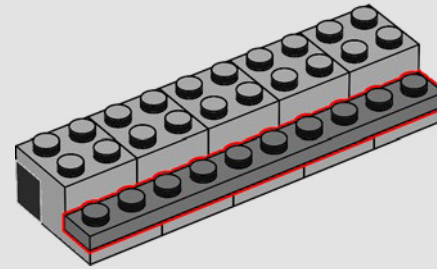

149

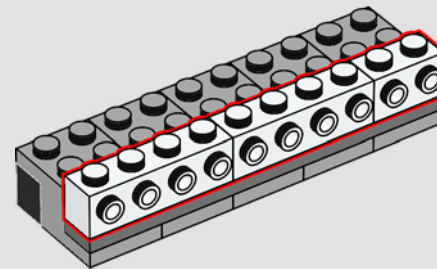

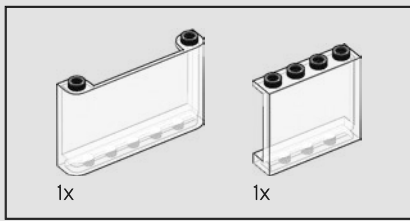

150

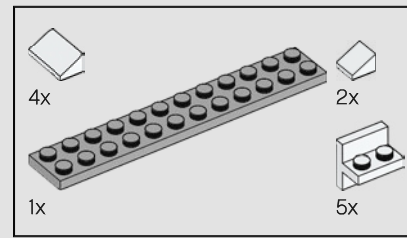
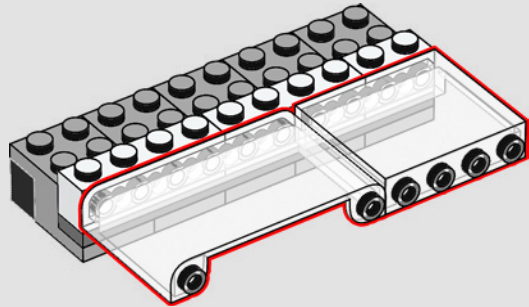

151

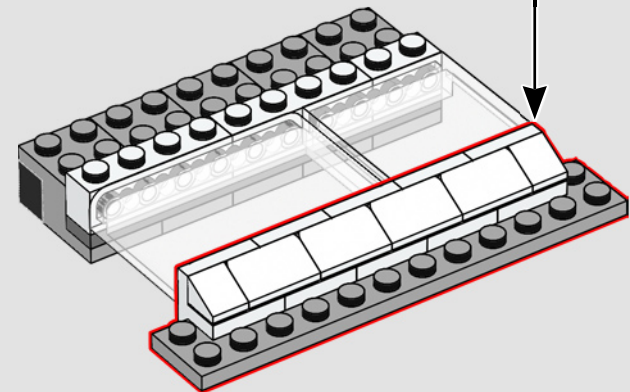
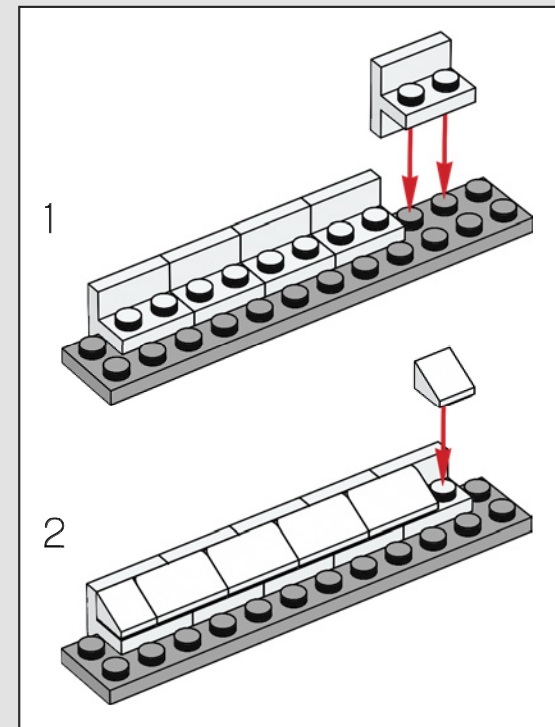

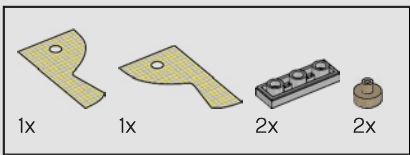

152

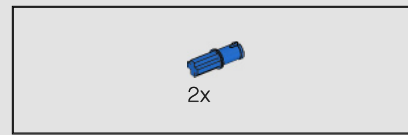
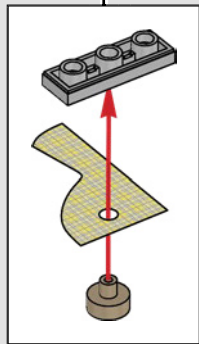
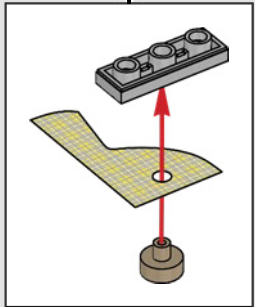
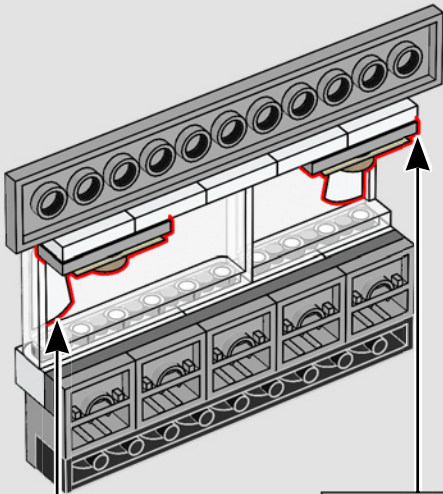

153

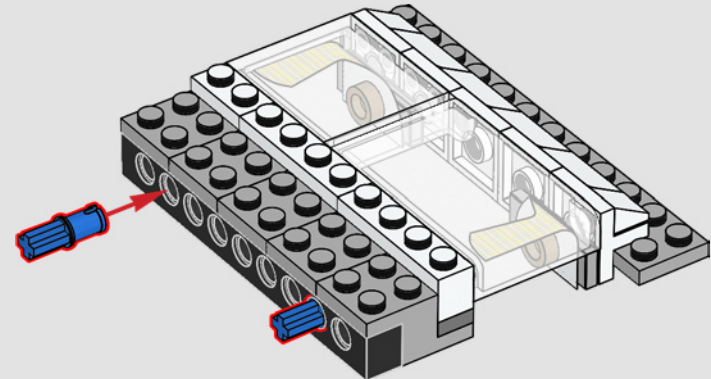

2x

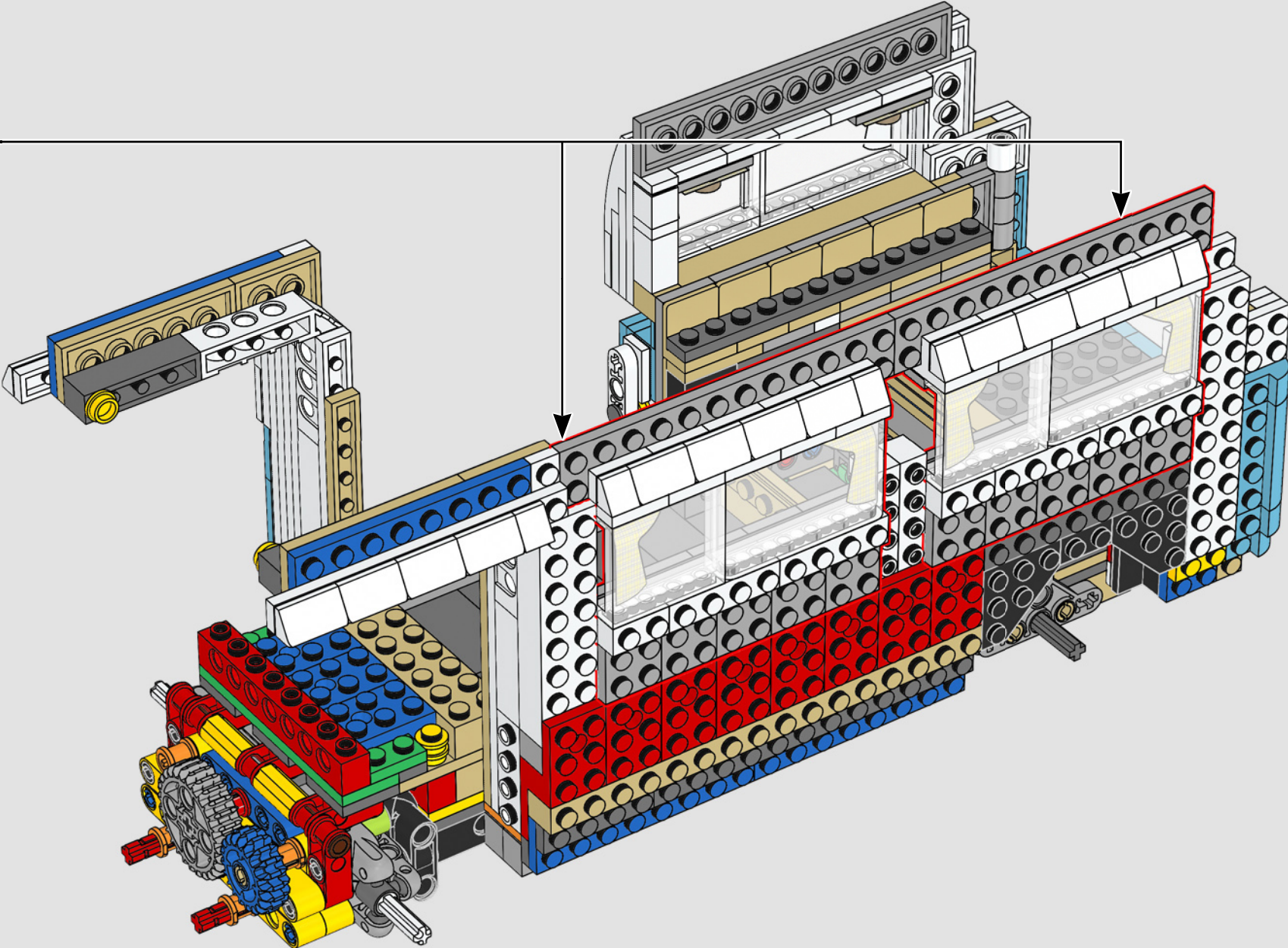

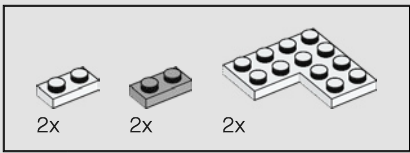

155

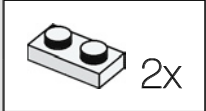
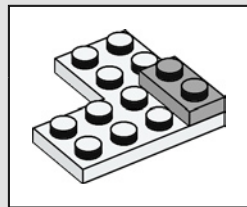
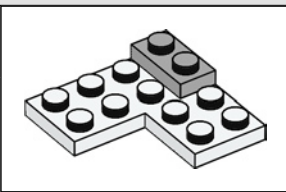
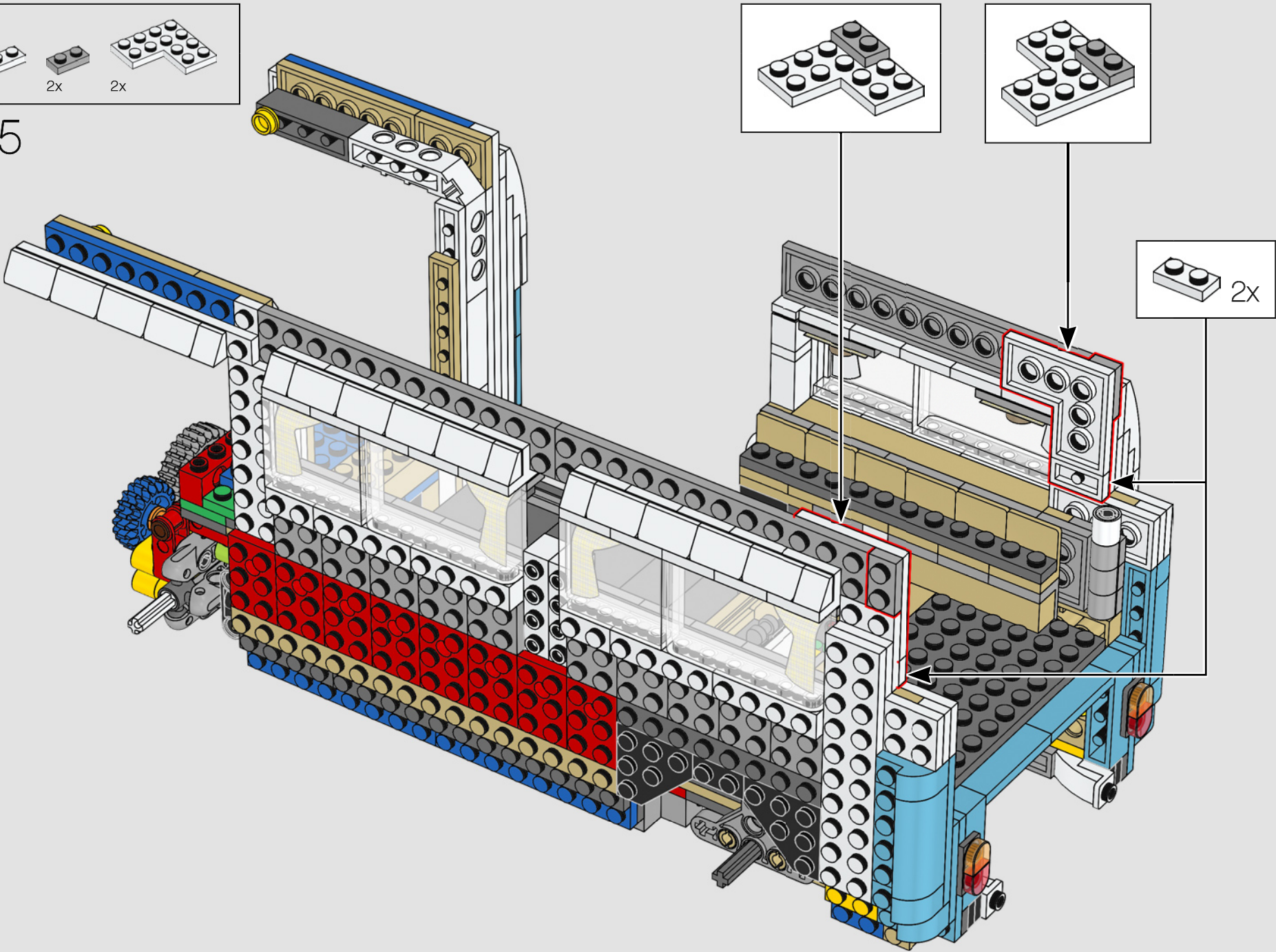

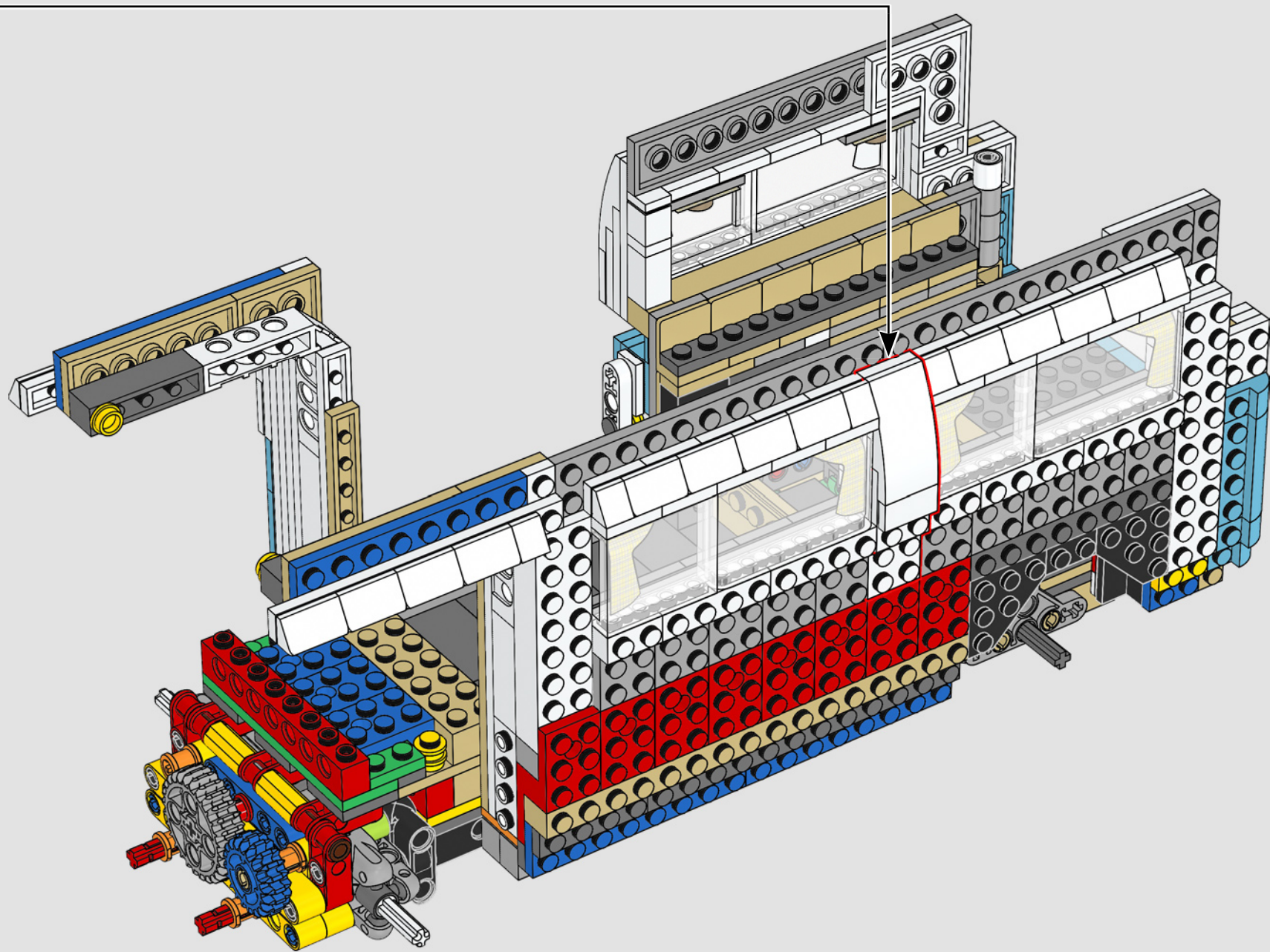

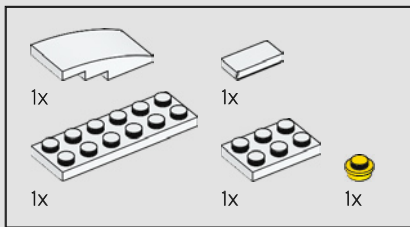

157

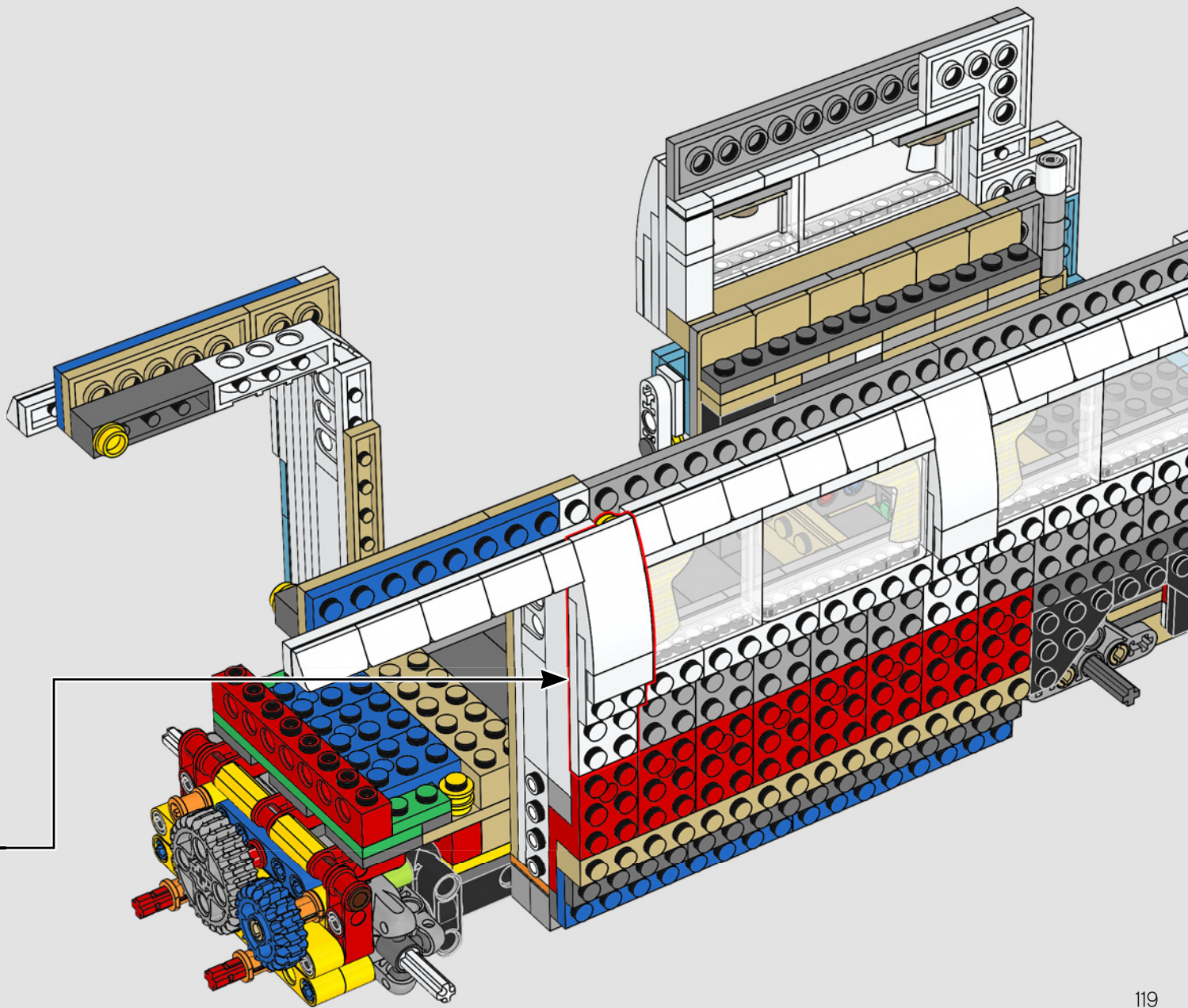
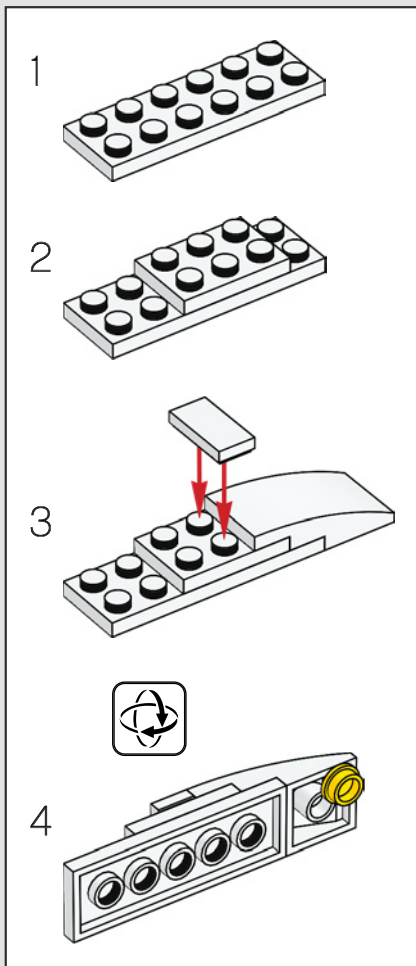

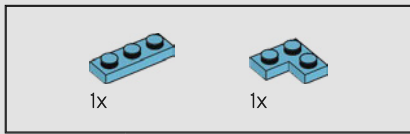

159

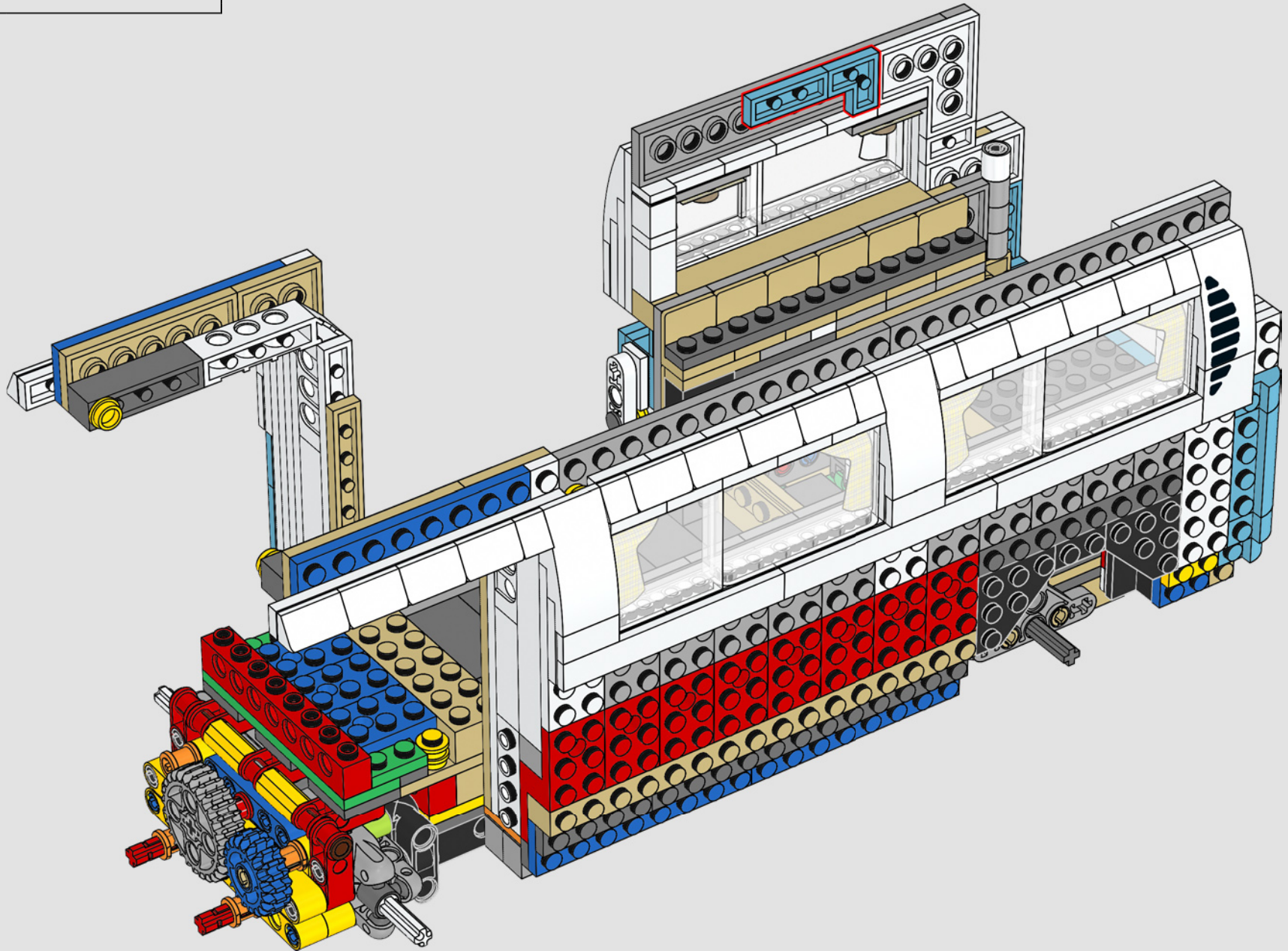

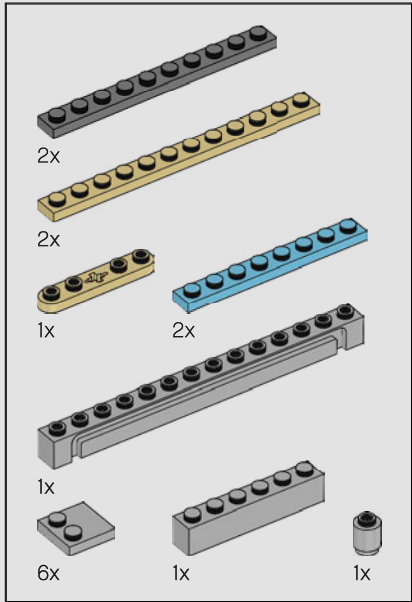
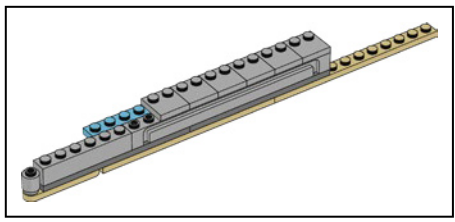

160

1

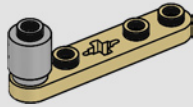

2

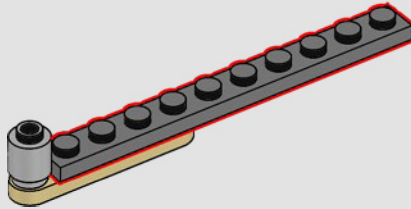

3

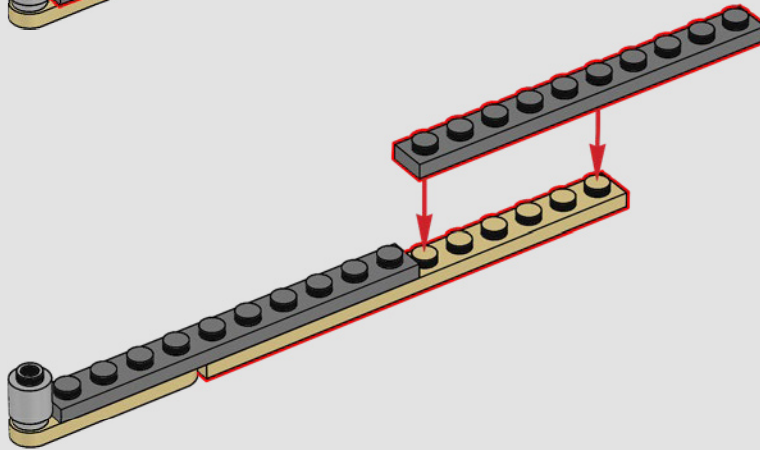

4

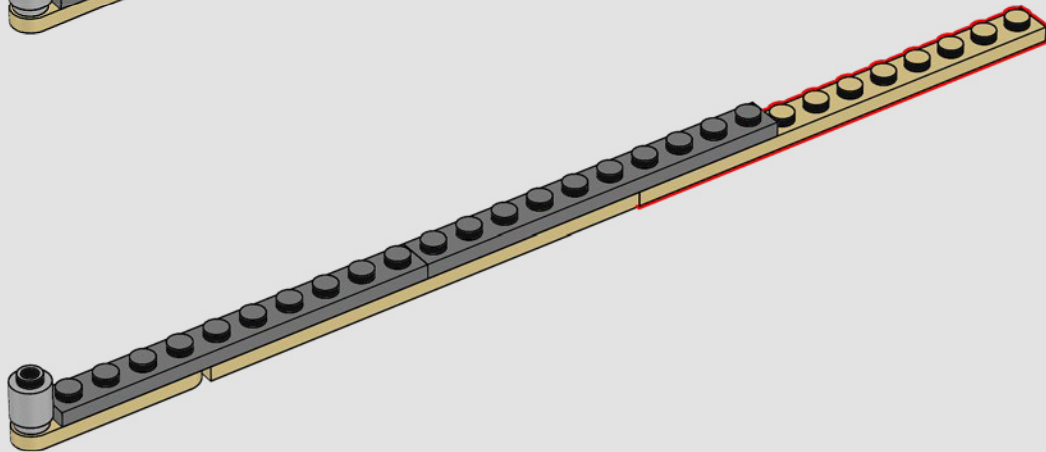

5

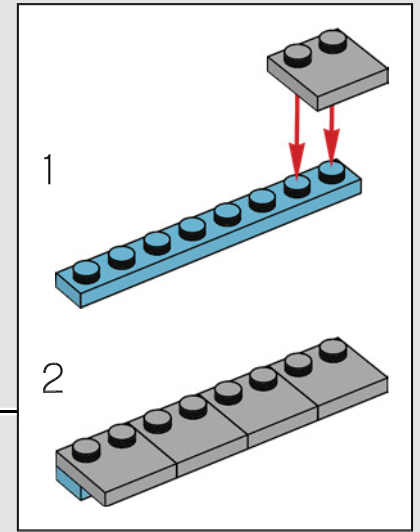
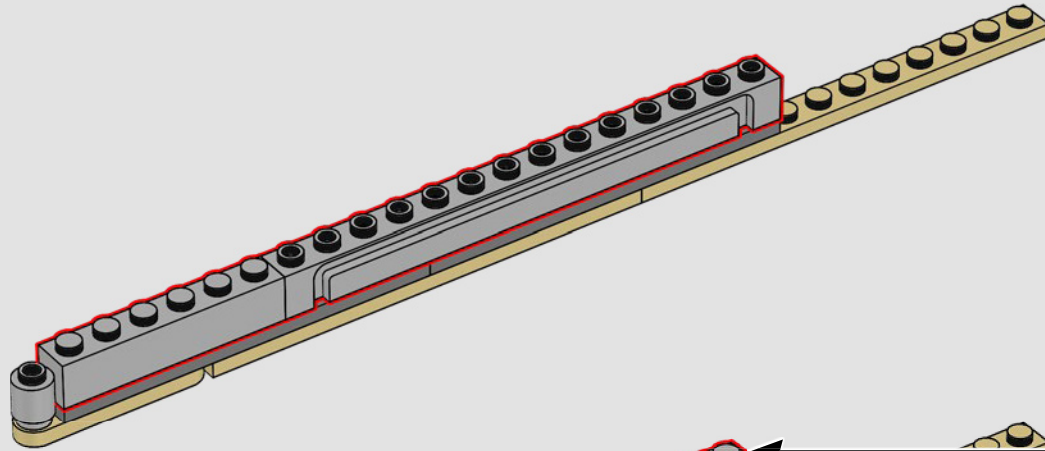

6

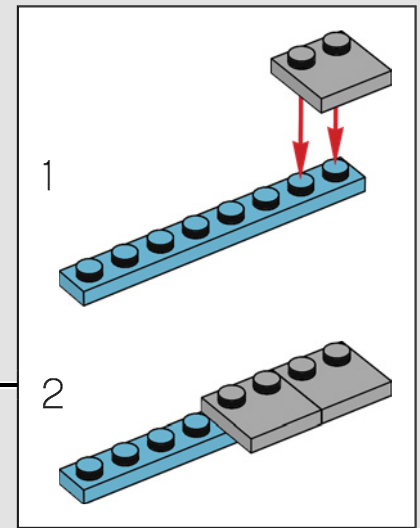
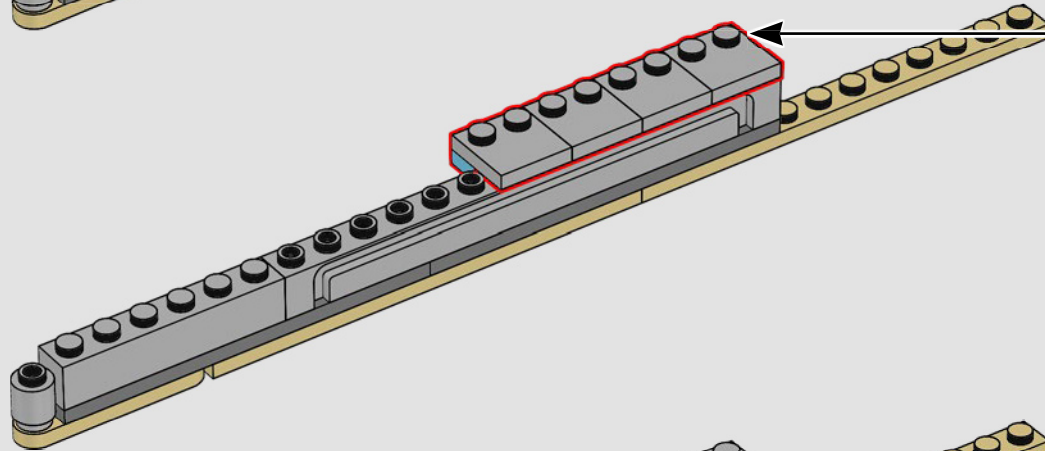

7

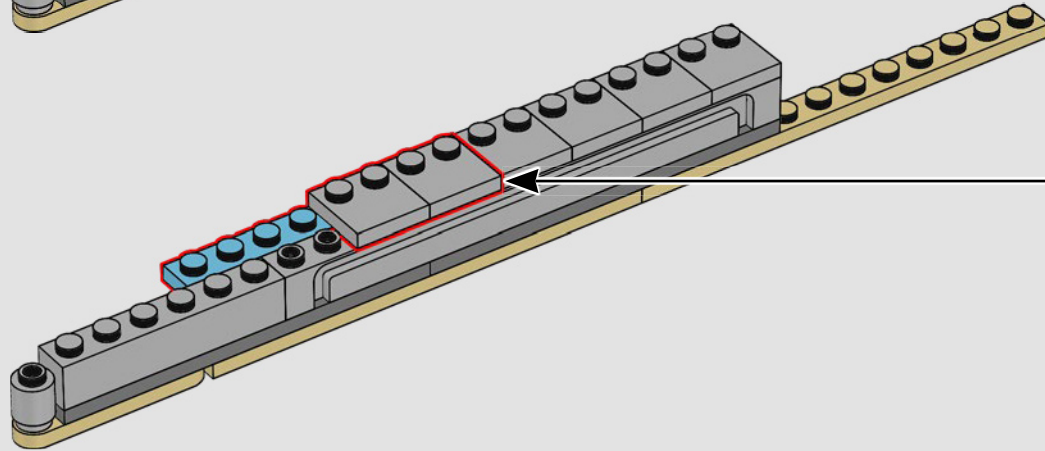

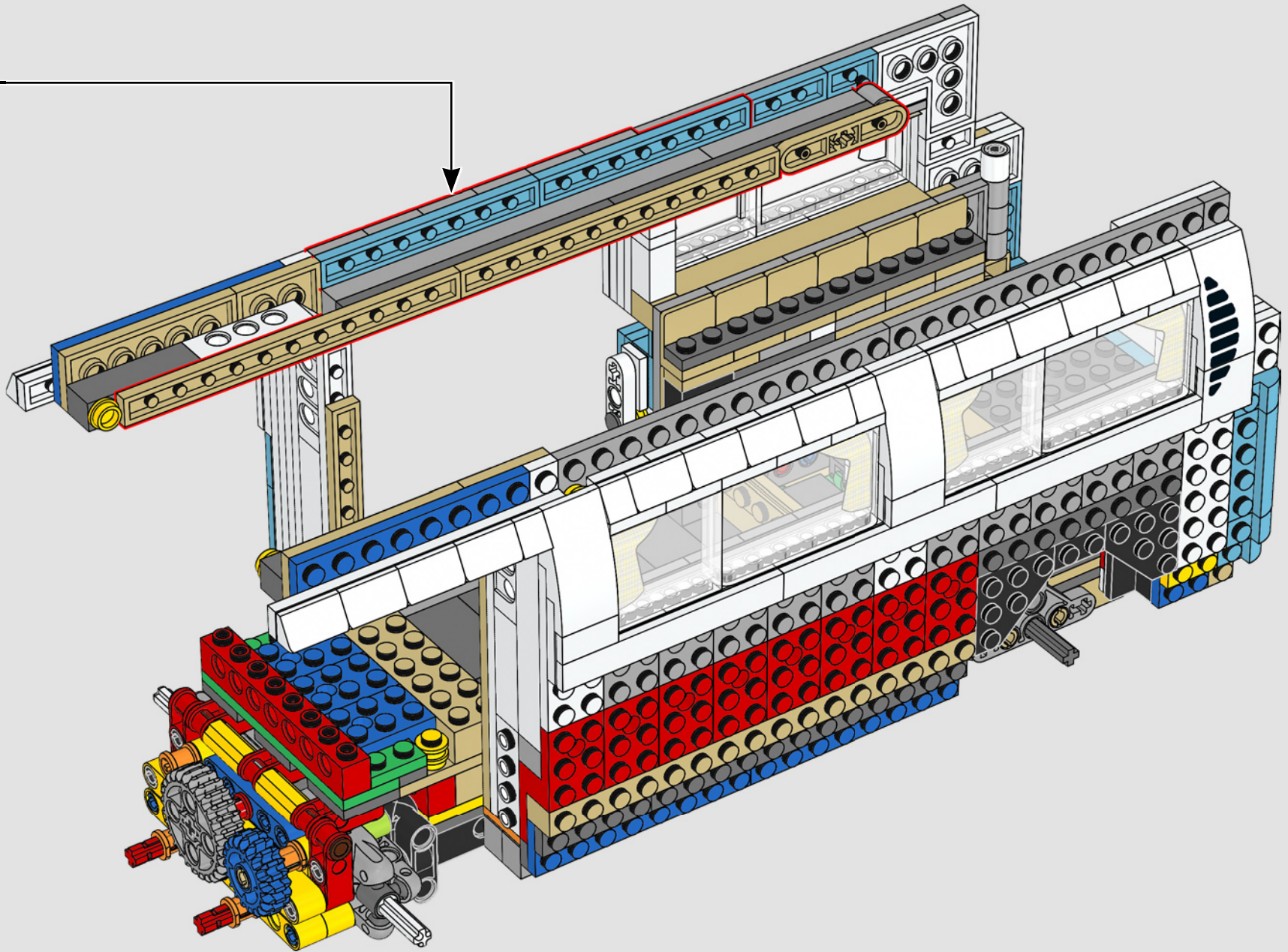

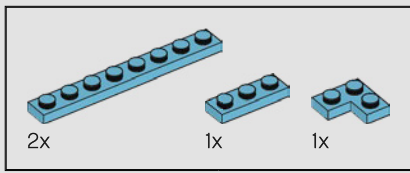

161

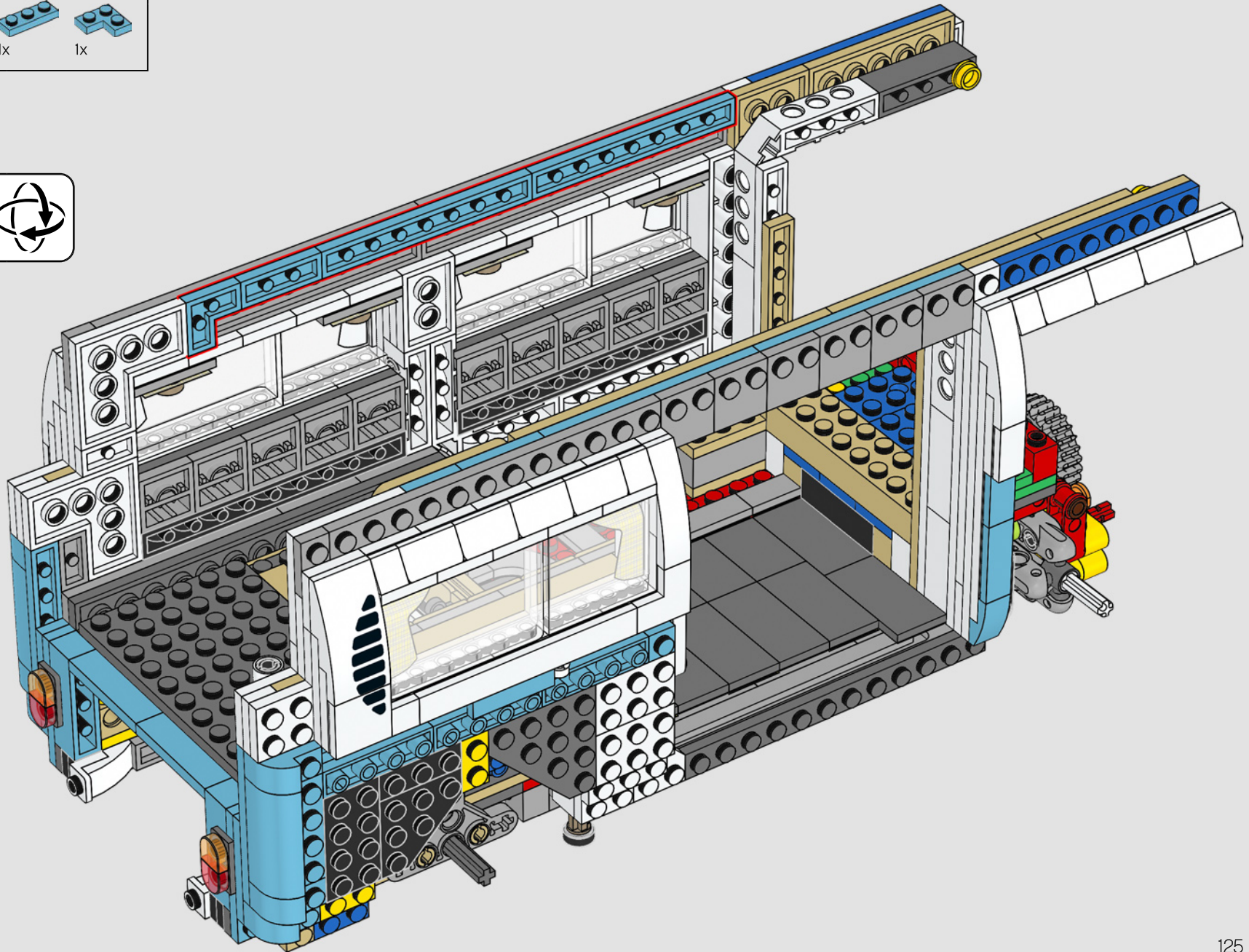

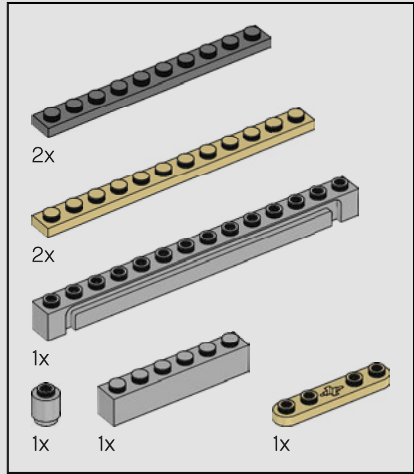
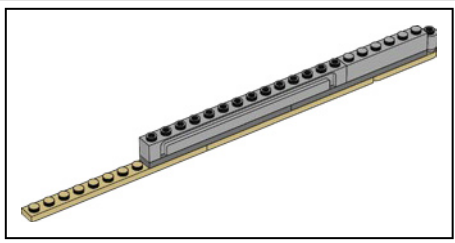

162

1

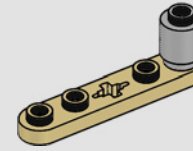

2

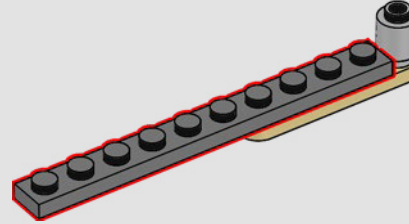

3

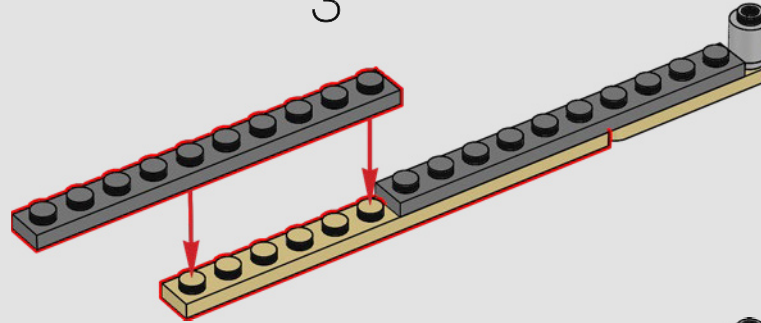

4

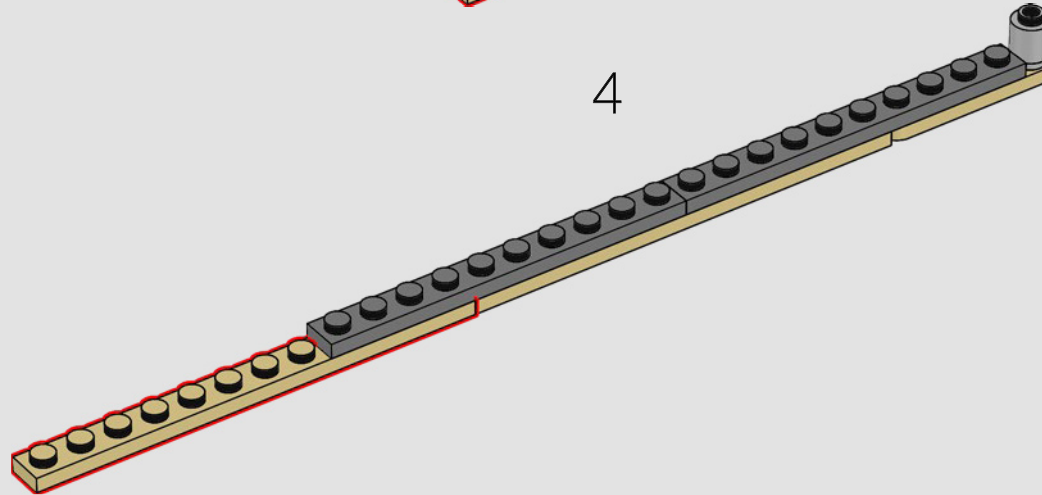

5

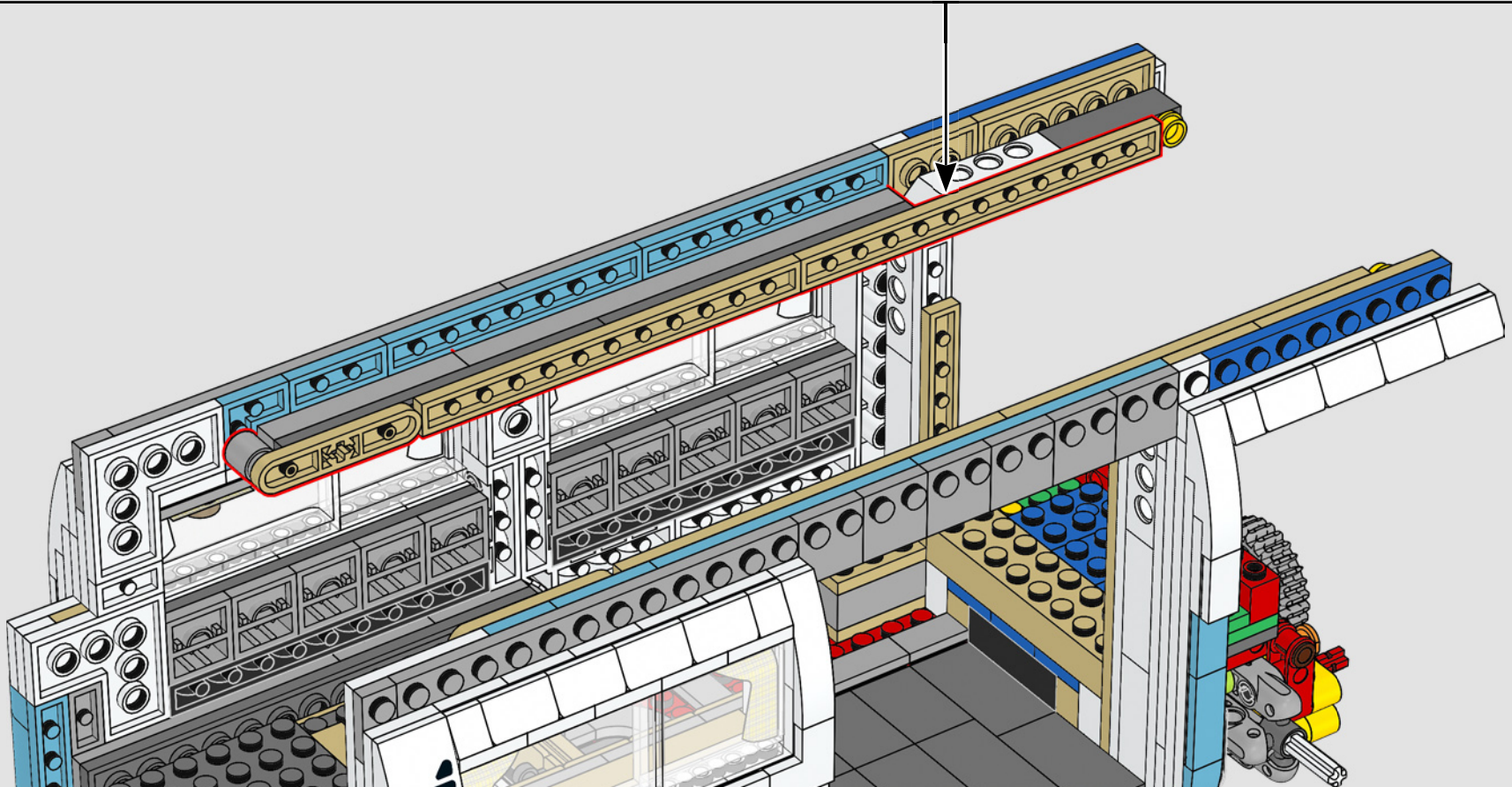
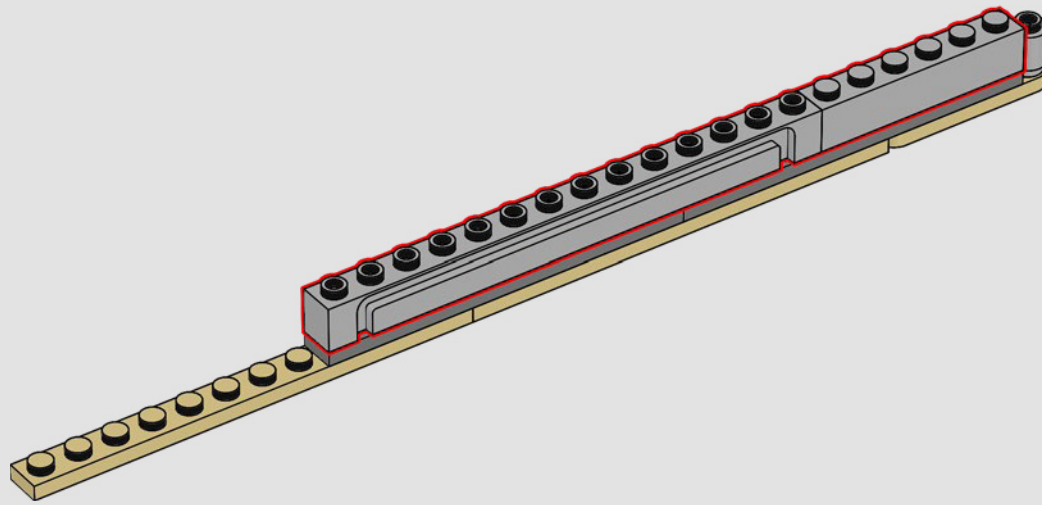

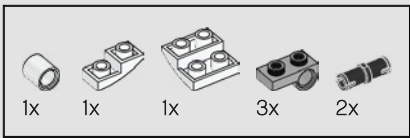

163

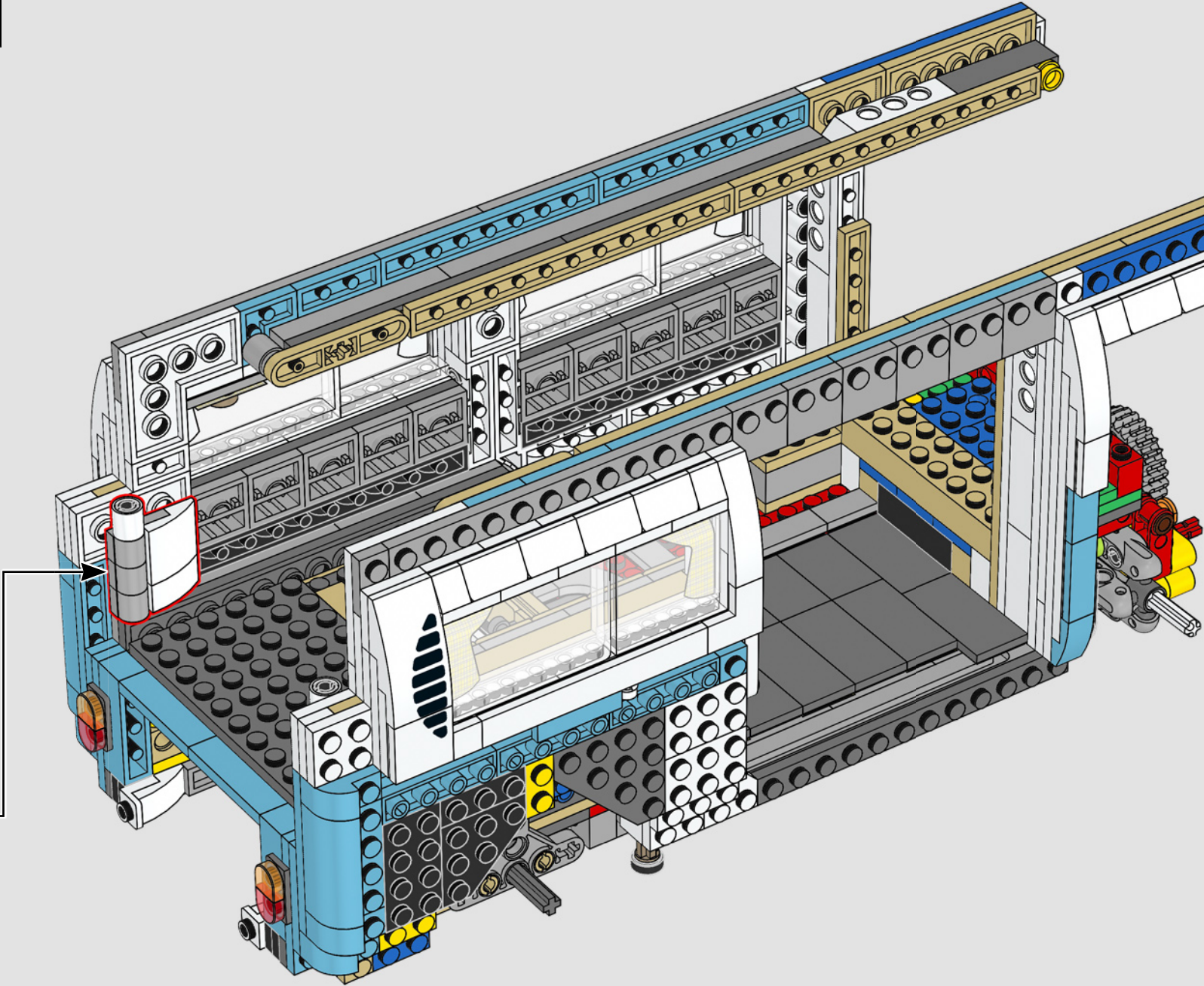
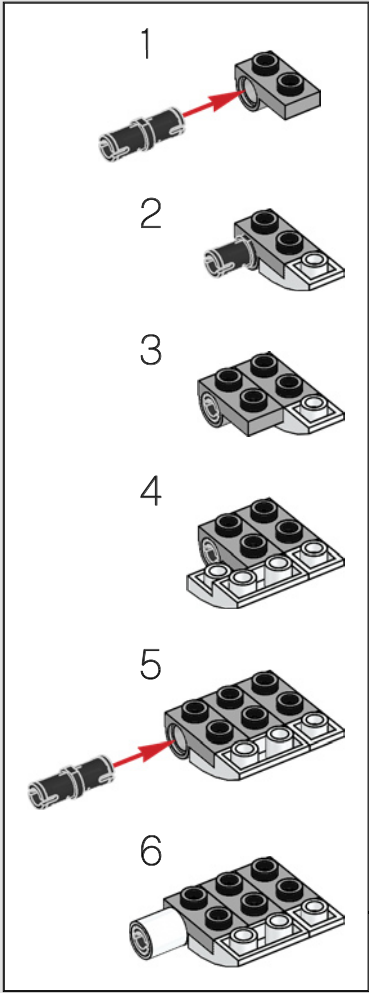

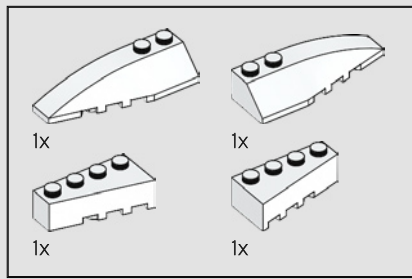

164

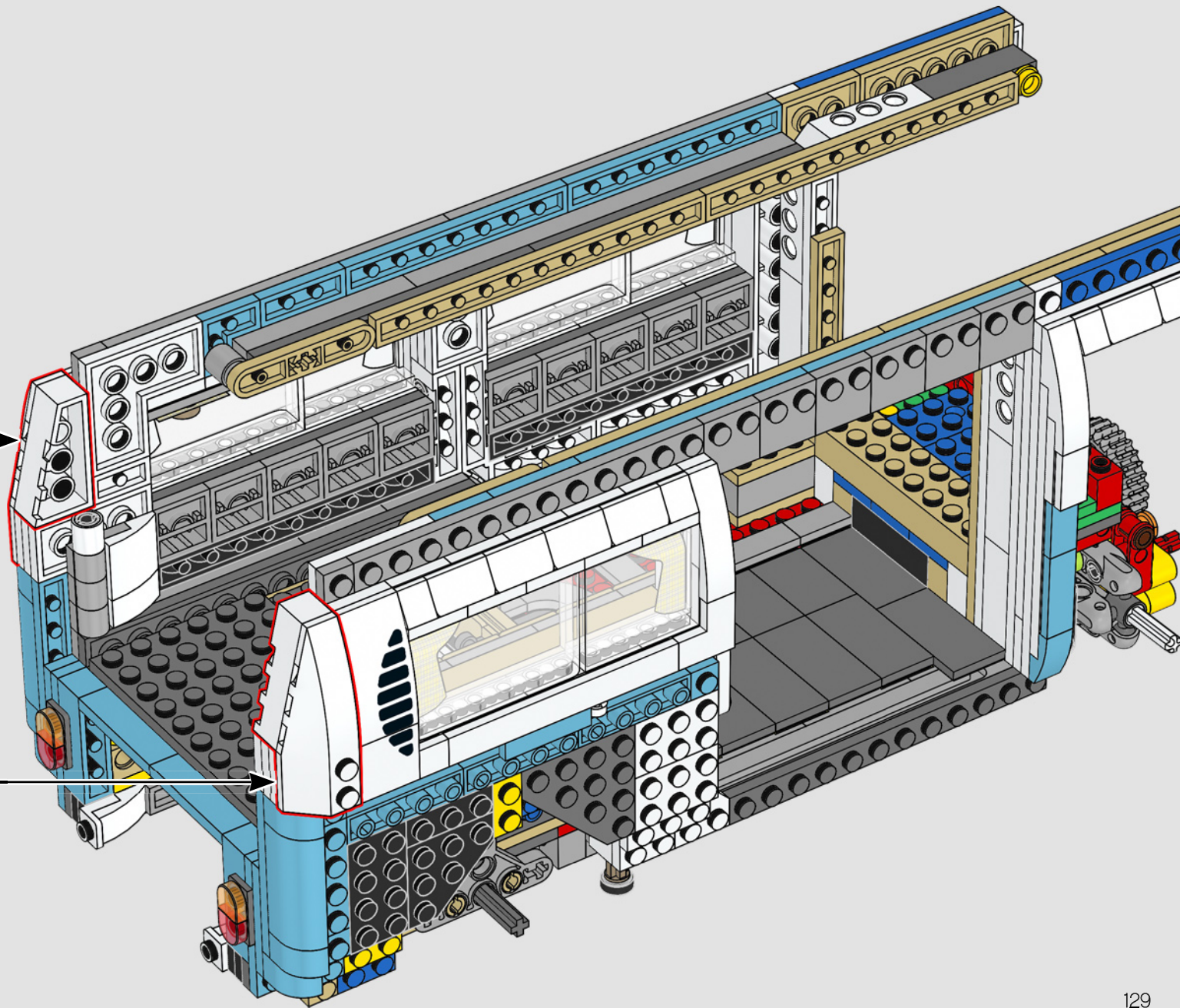
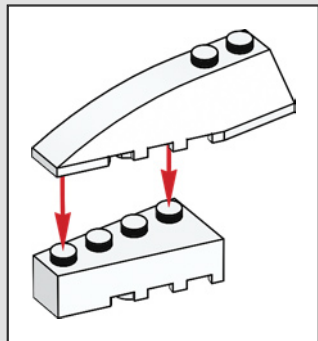
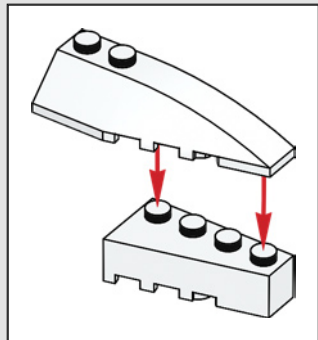

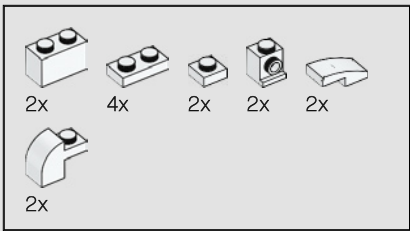

165

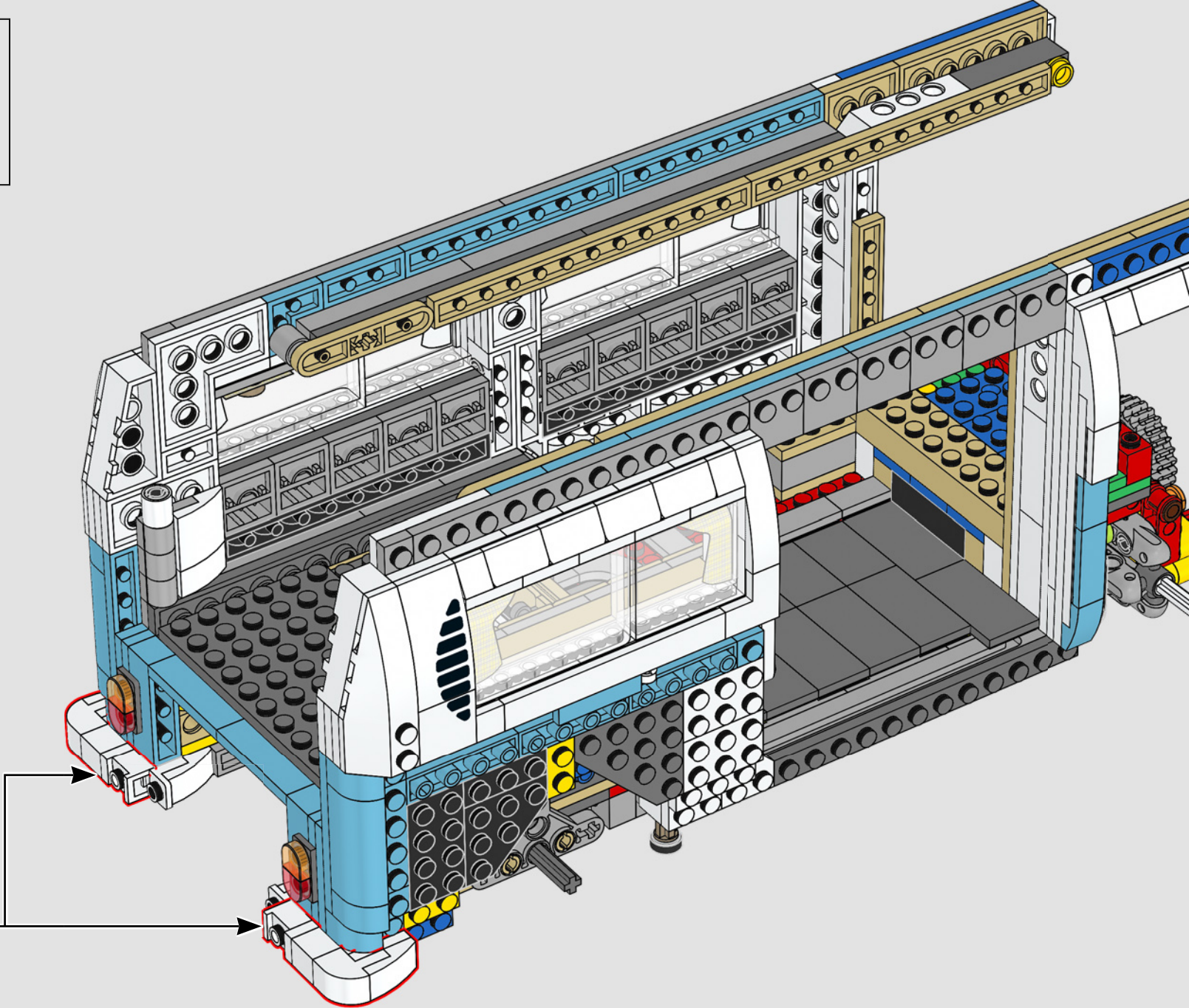
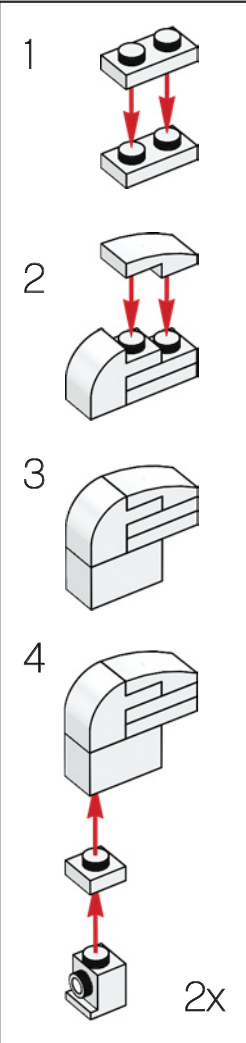



166

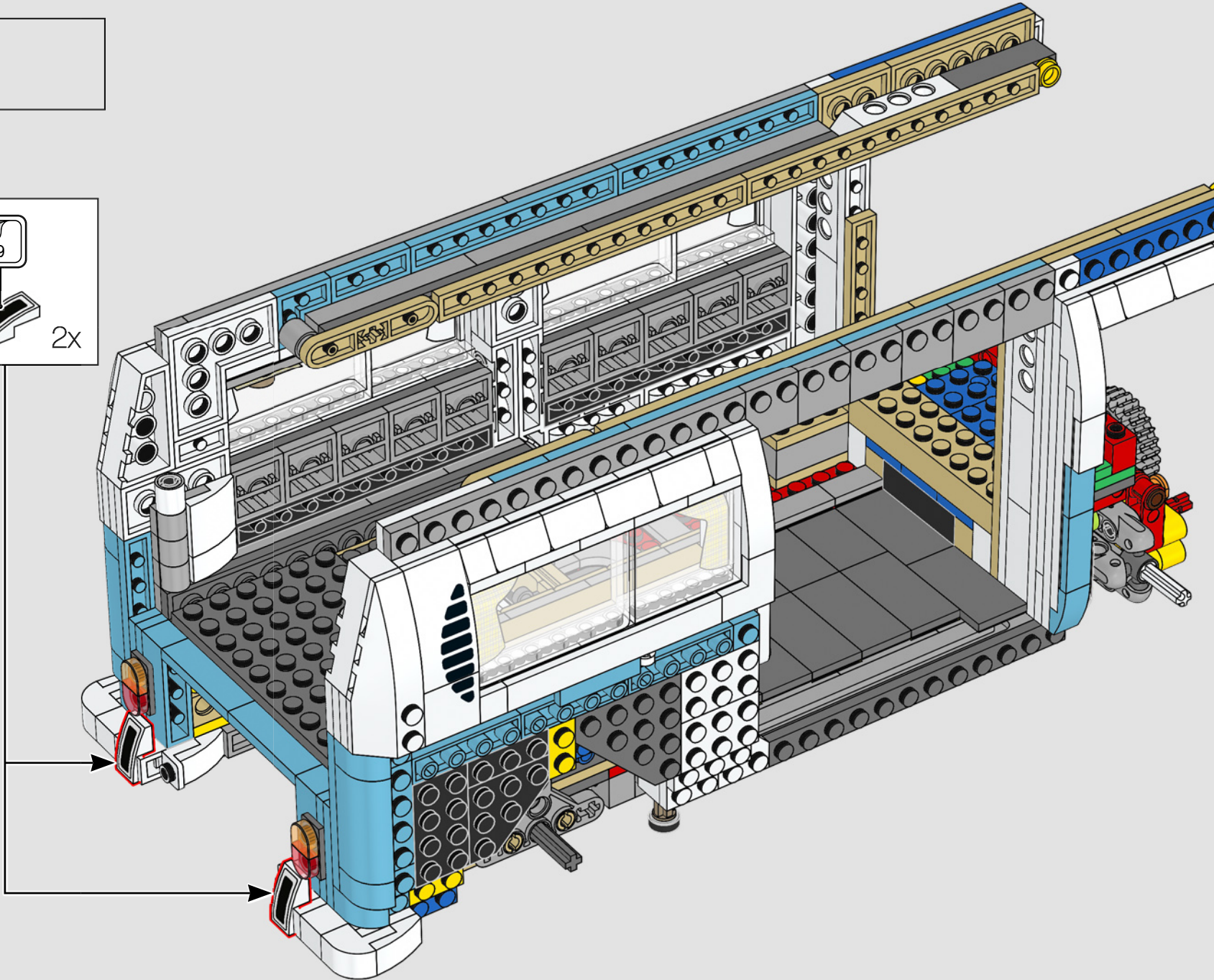
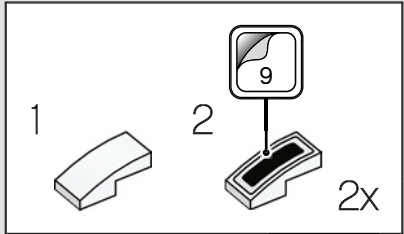

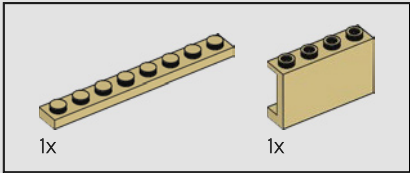
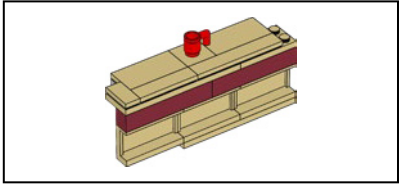
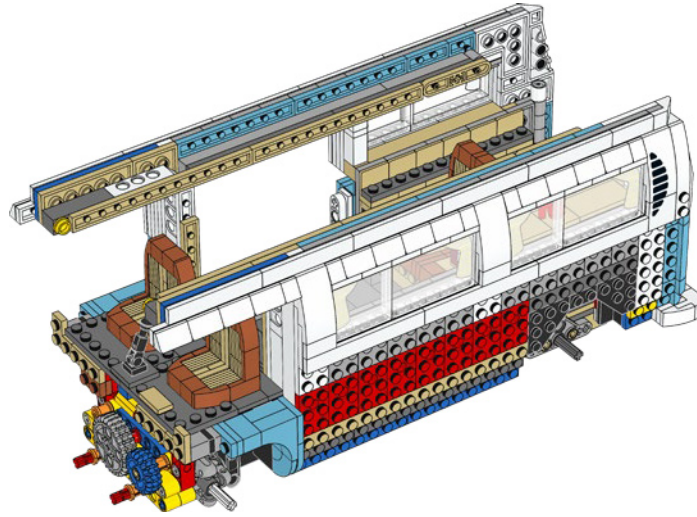

167

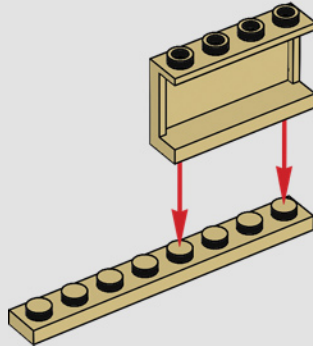

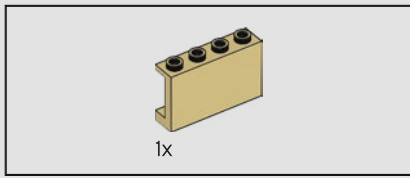

168

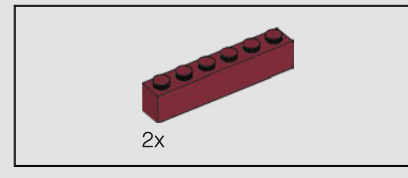
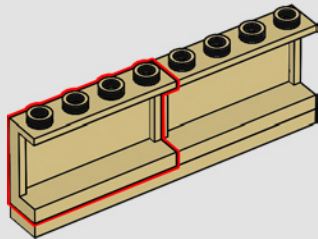

169

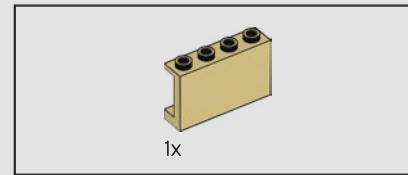
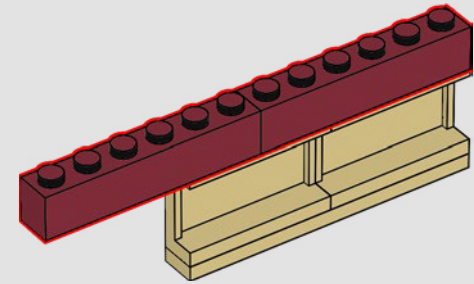

170

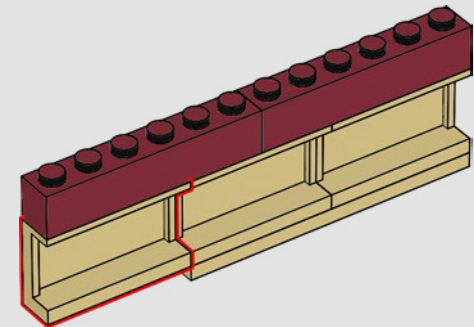

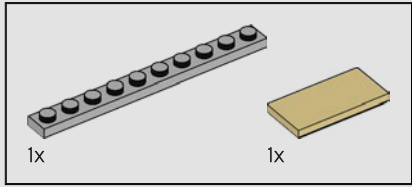
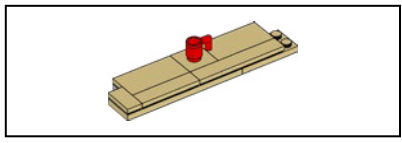

171

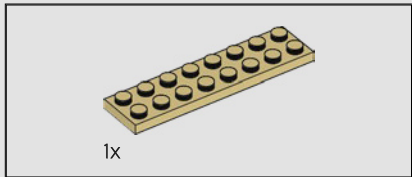
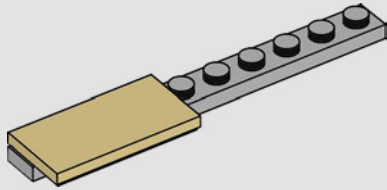

172

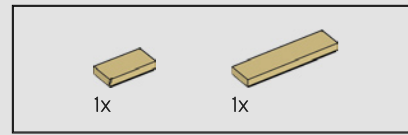
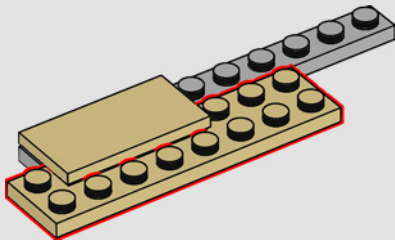

173

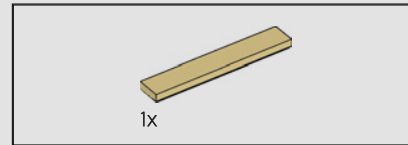
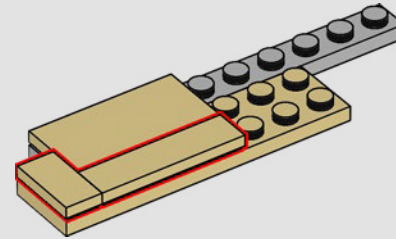

174

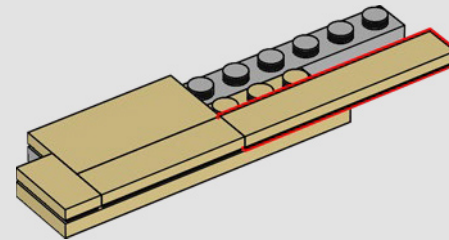

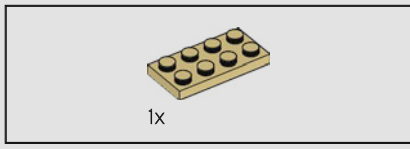

175

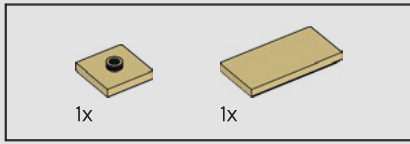
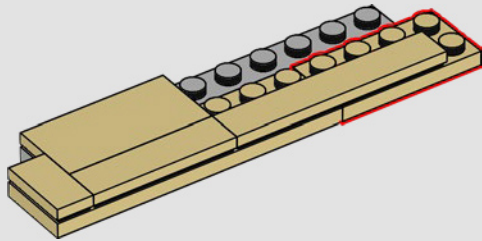

176

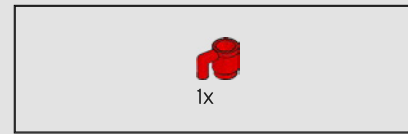
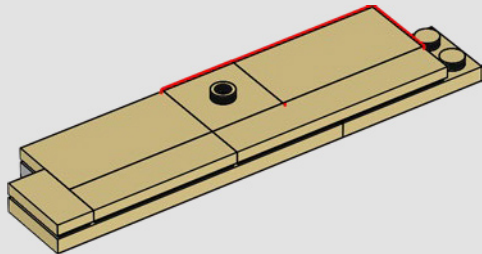

177

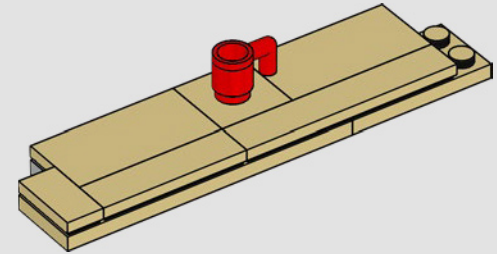

178

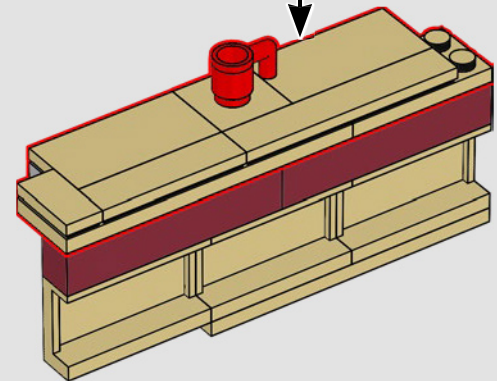

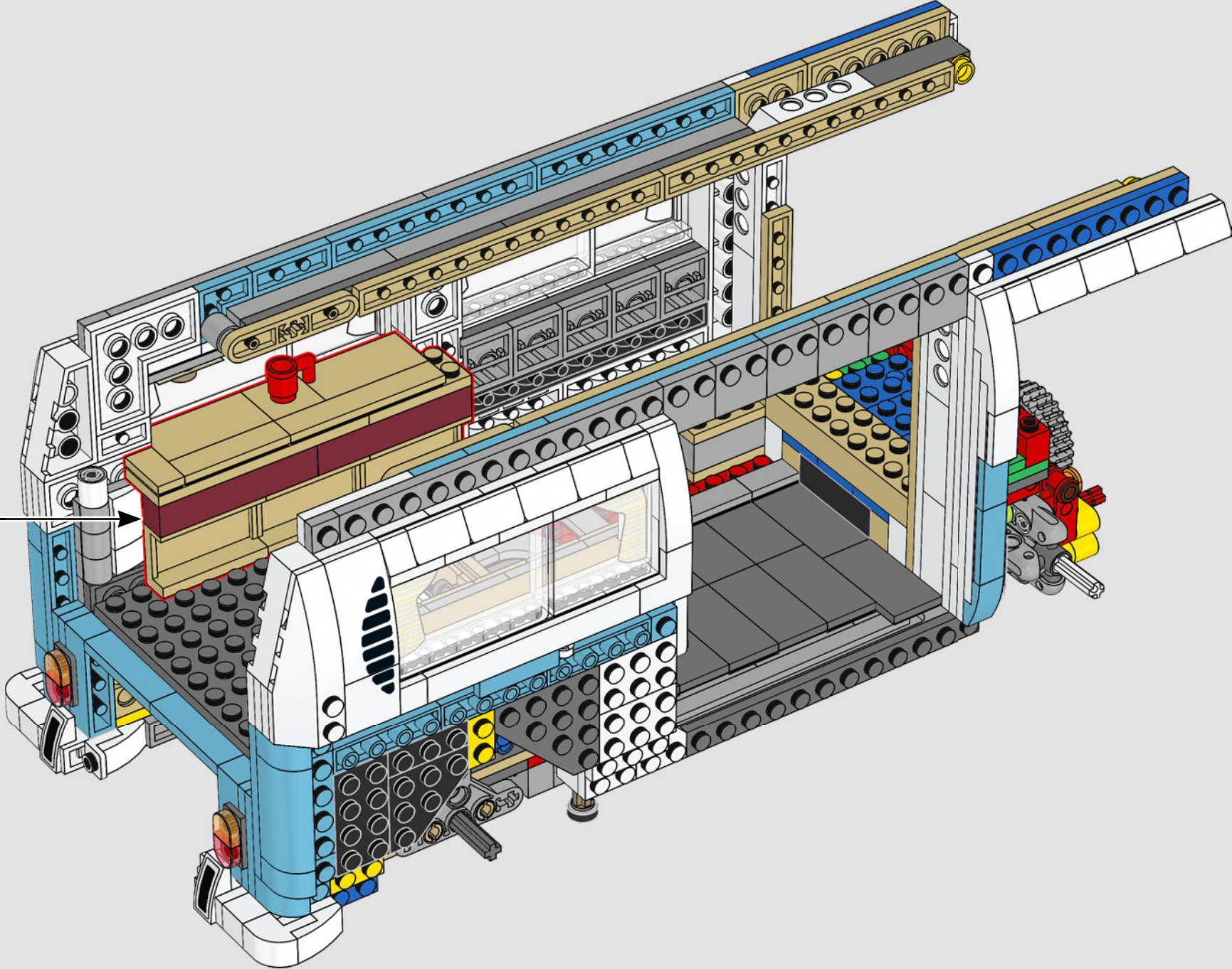

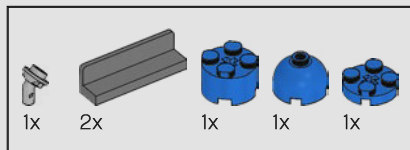

180

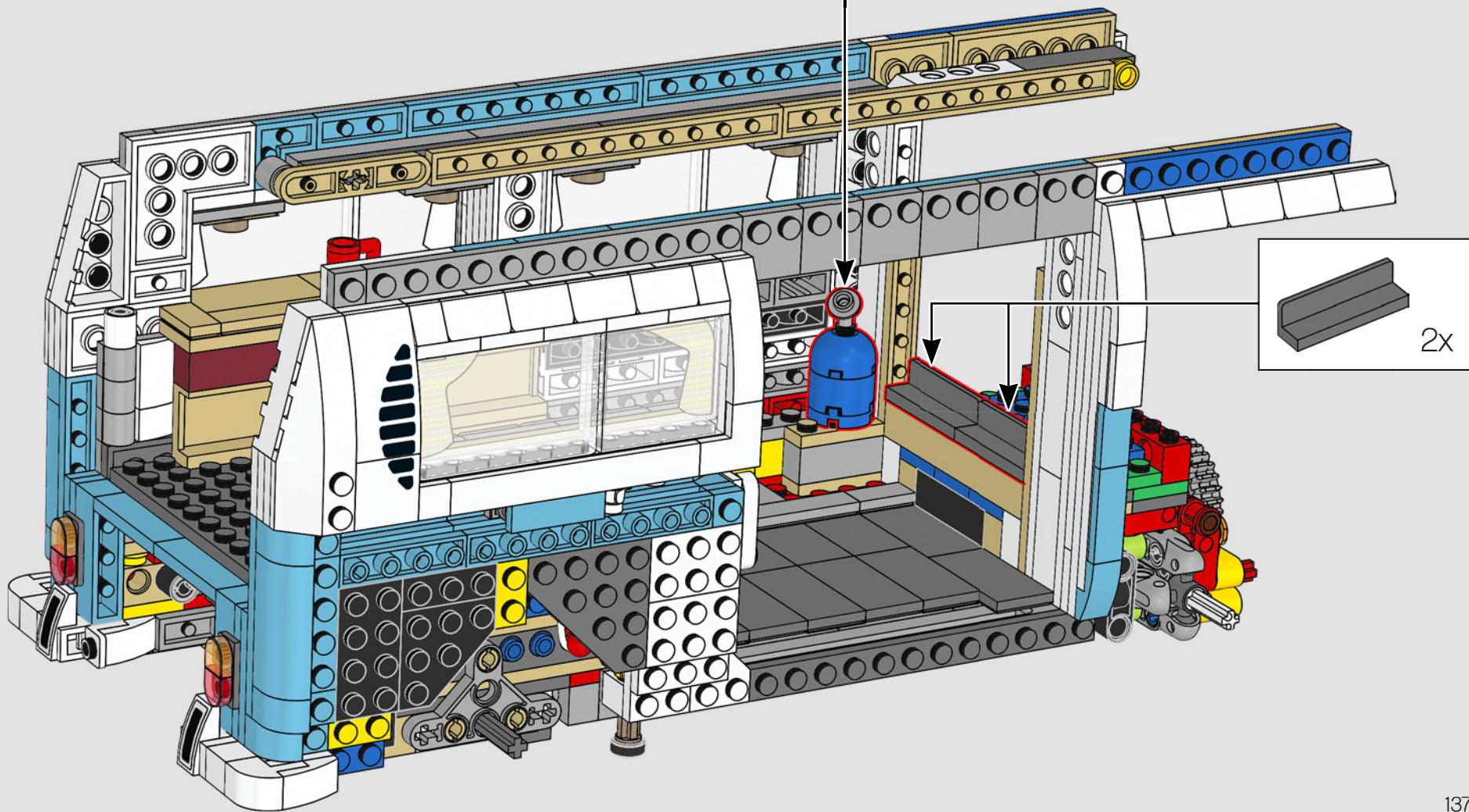
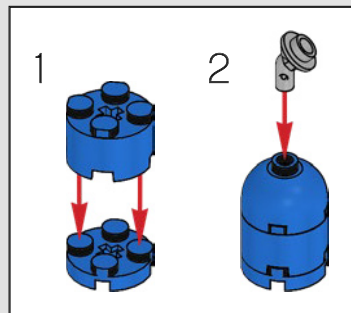

I frigoriferi dei camper negli anni '70 erano in genere alimentati a gas propano, il quale veniva utilizzato anche per i fornelli e la stufa della cabina.

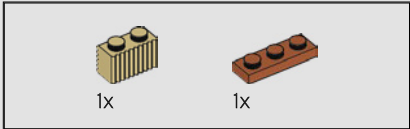
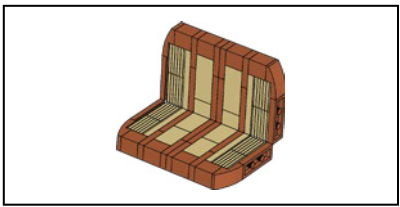

181

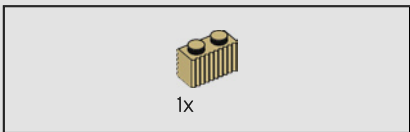
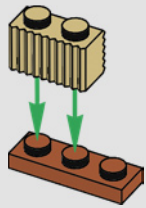

182

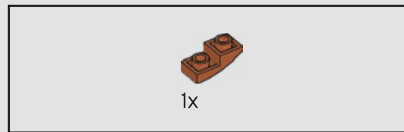
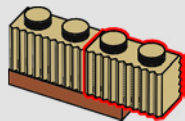

183

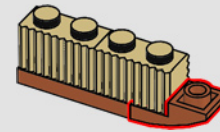

184

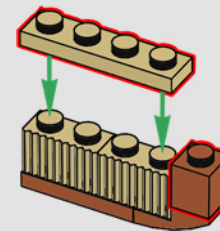

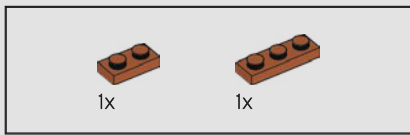

185

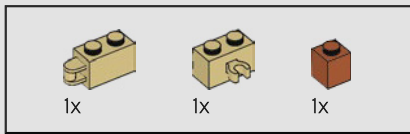
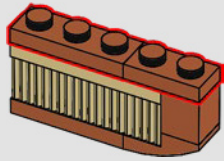

186

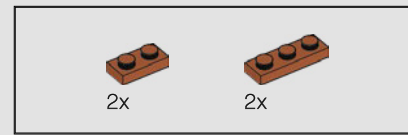
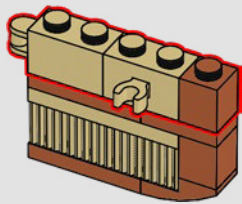

187

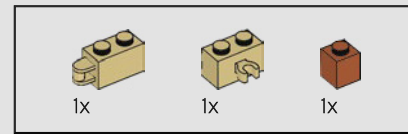
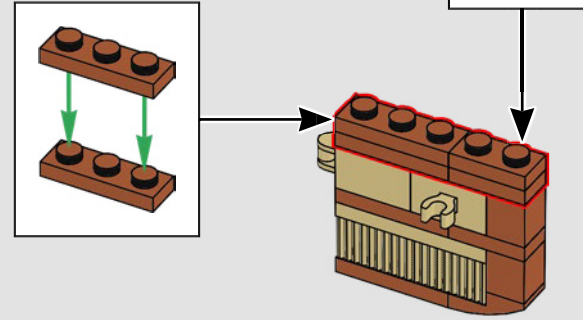

188

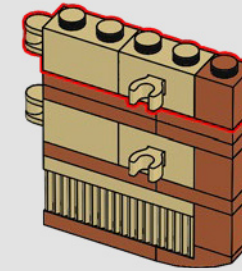

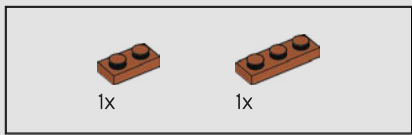

189

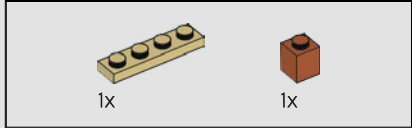
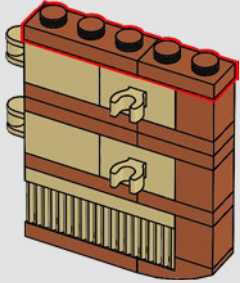

190

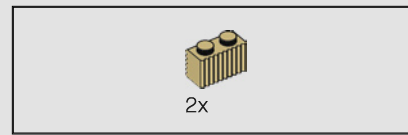
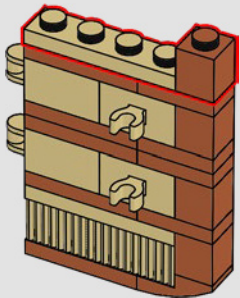

191

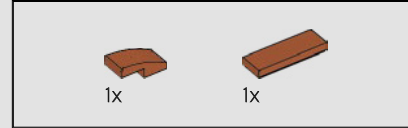
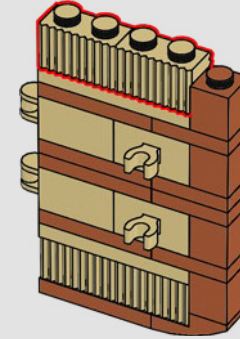

192

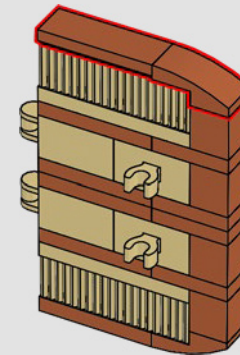

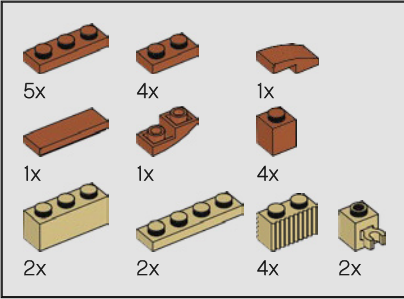
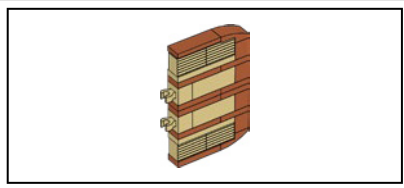

193

1

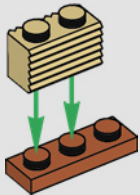

2

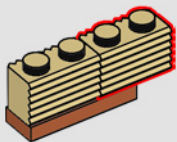

3

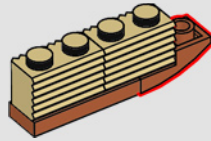

4

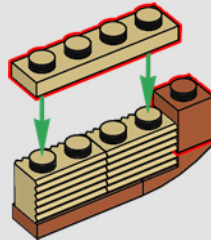

5

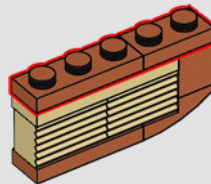

6

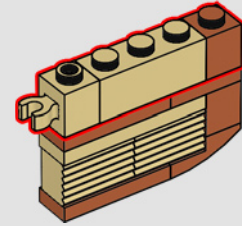

7

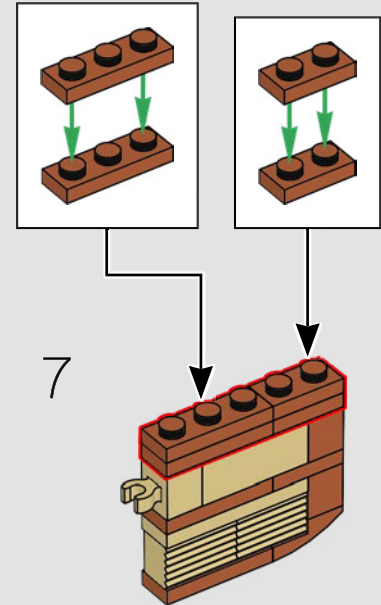

8

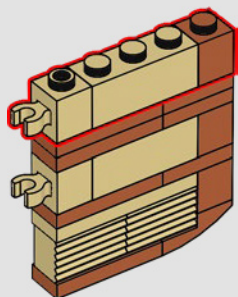

9

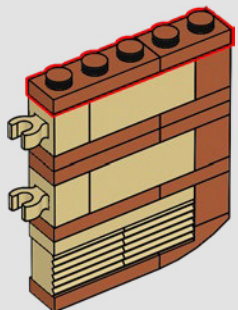

10

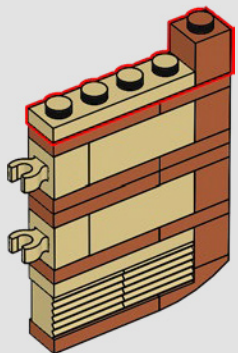

11

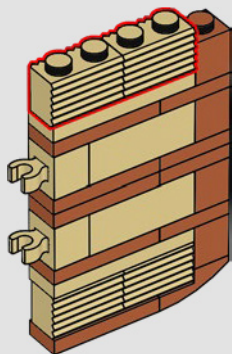

12

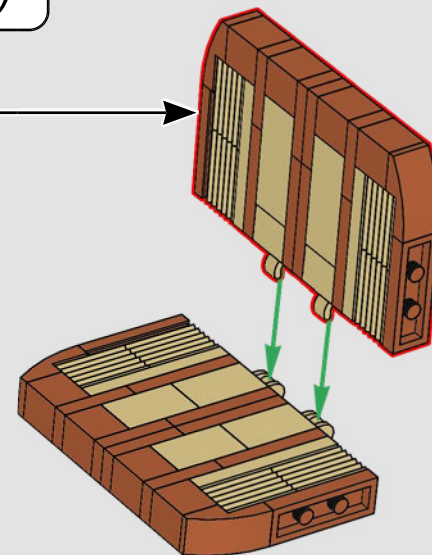
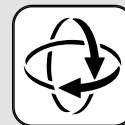
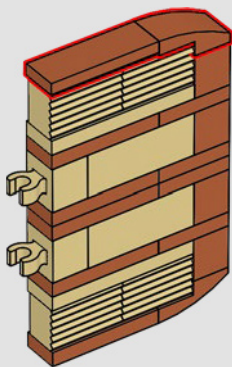

Il sedile a panchina posteriore sulle versioni da campeggio del veicolo poteva essere convertito in letto. Questa soluzione è nota come letto "rock and roll".

194

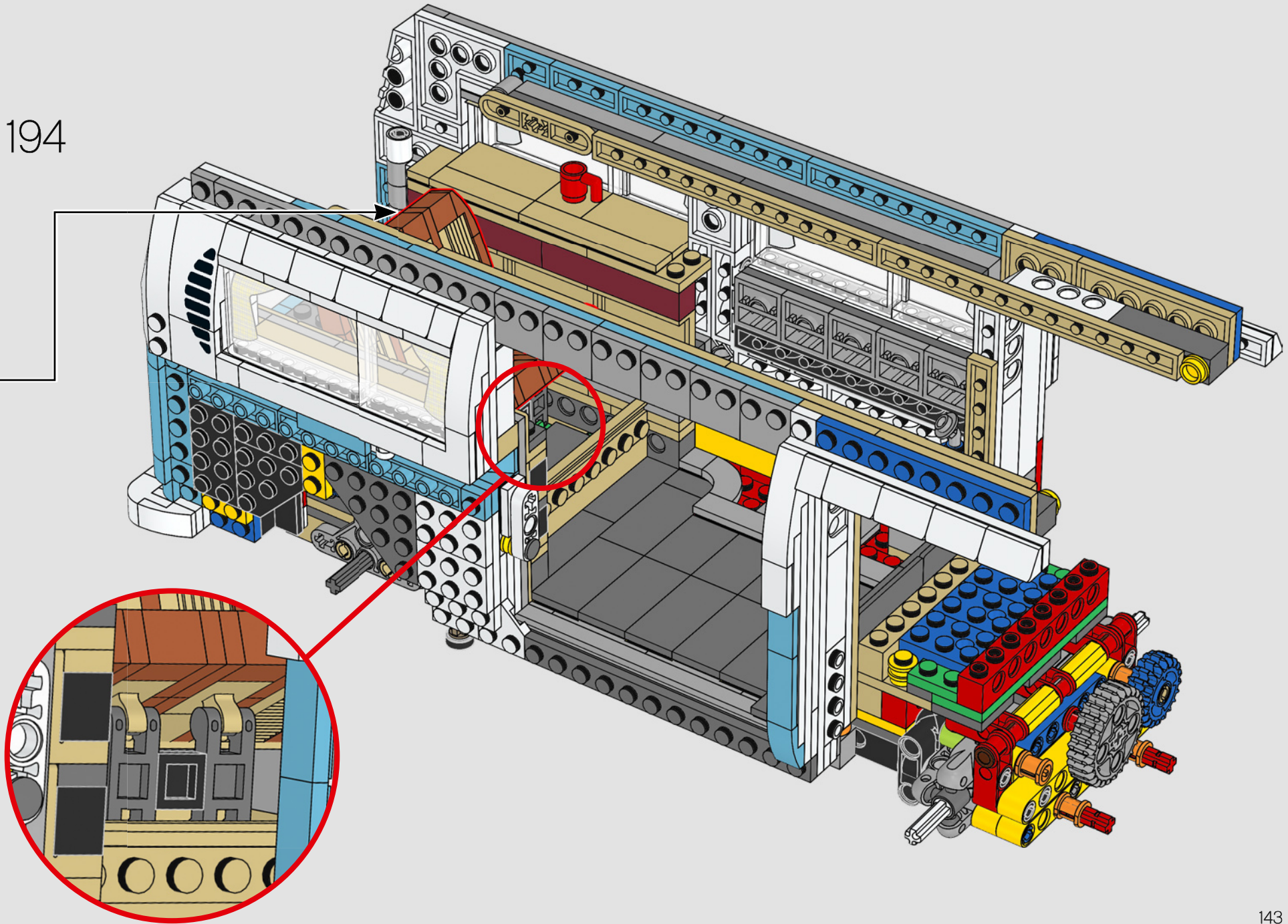

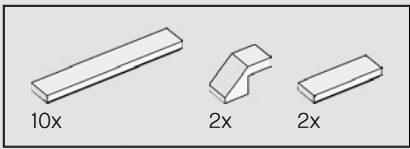

195

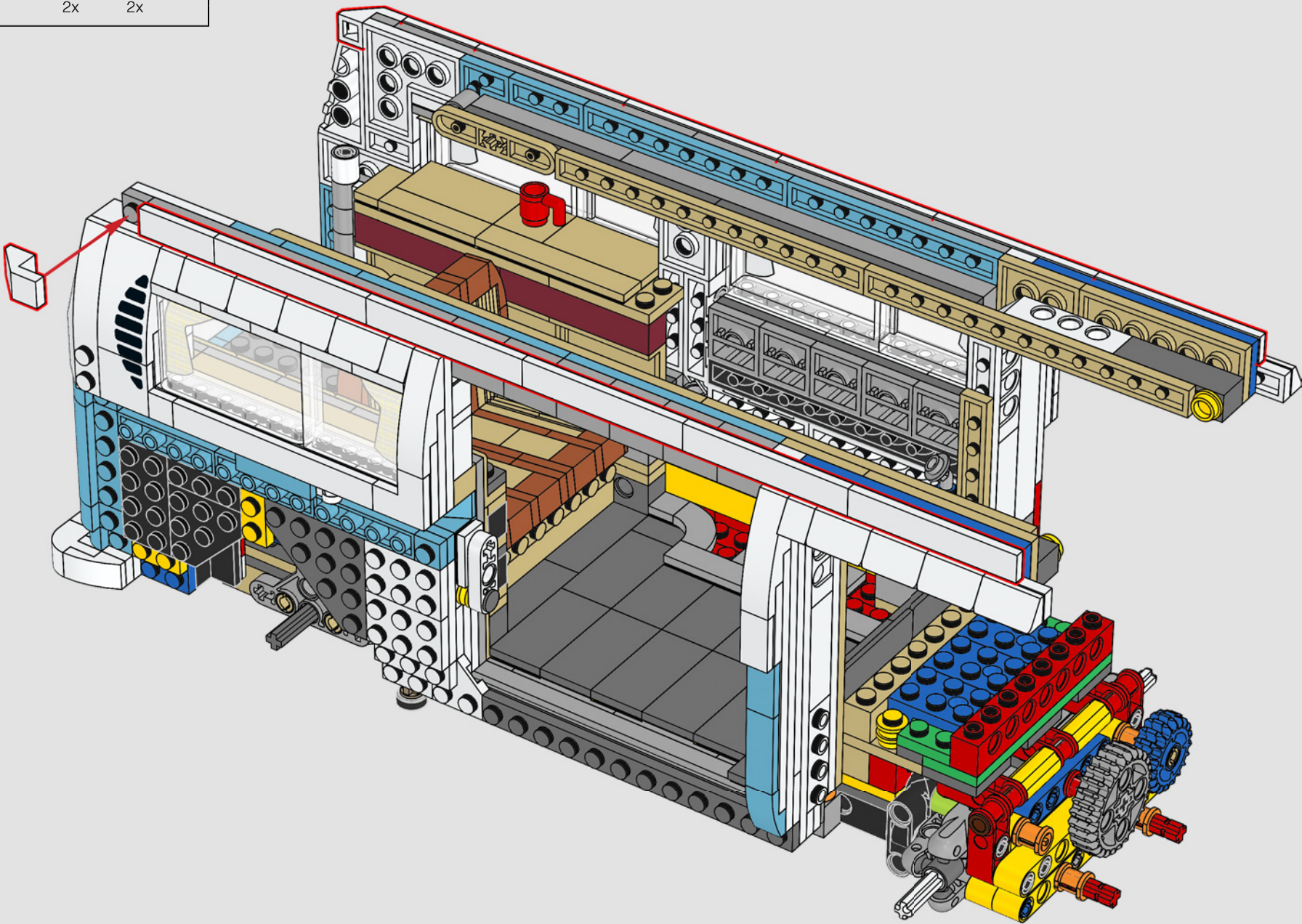

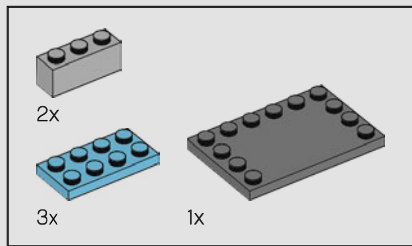

196

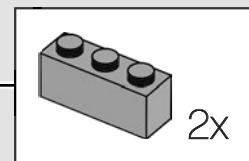
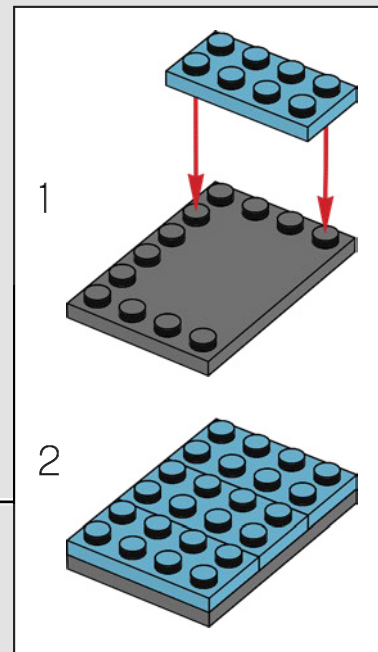
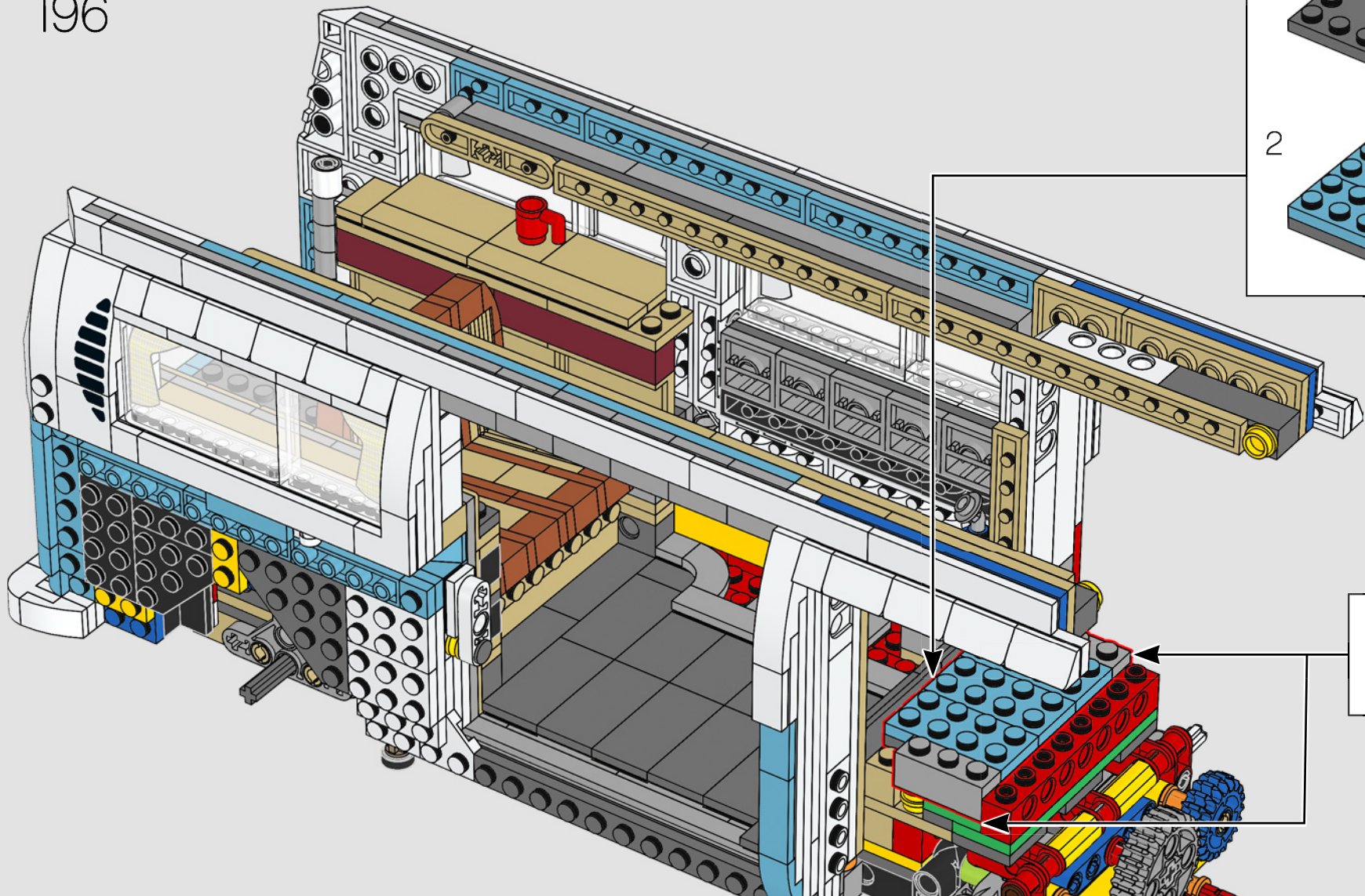

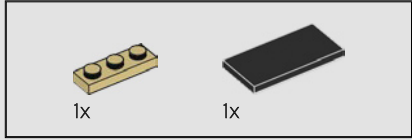
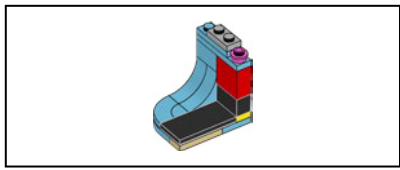

197

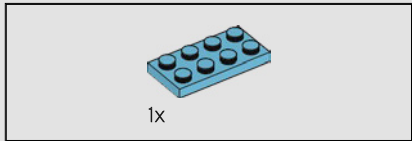
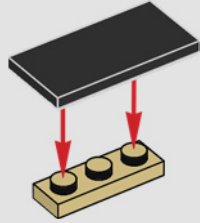

198

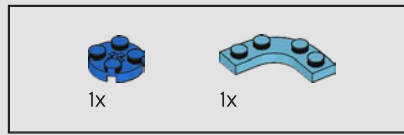
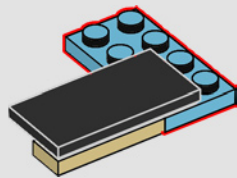

199

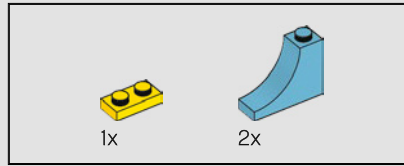
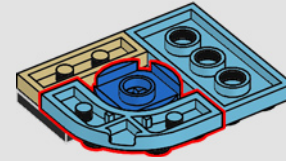
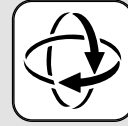

200

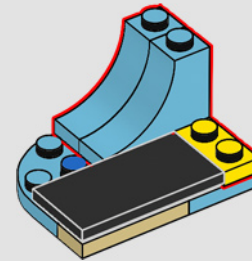
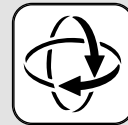

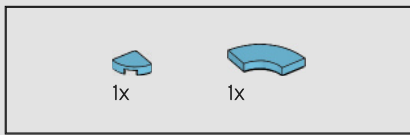

201

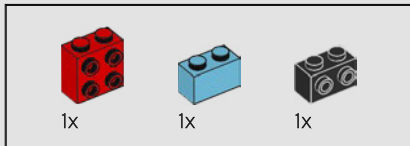
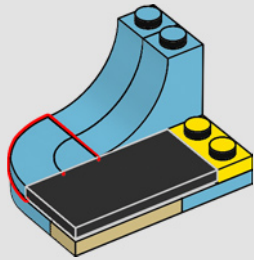

202

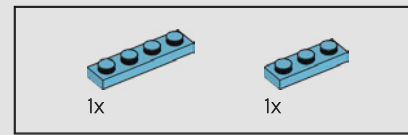
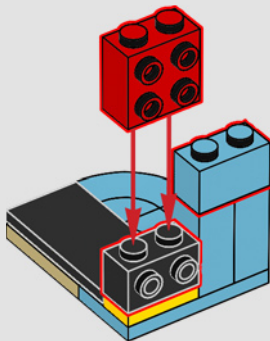

203

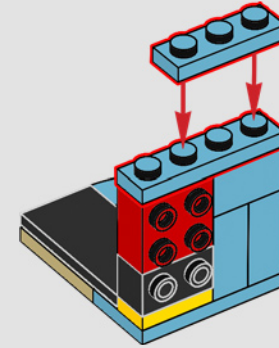

204

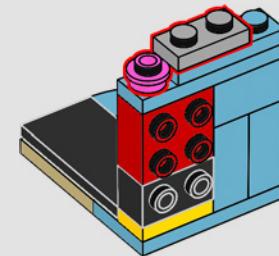

205

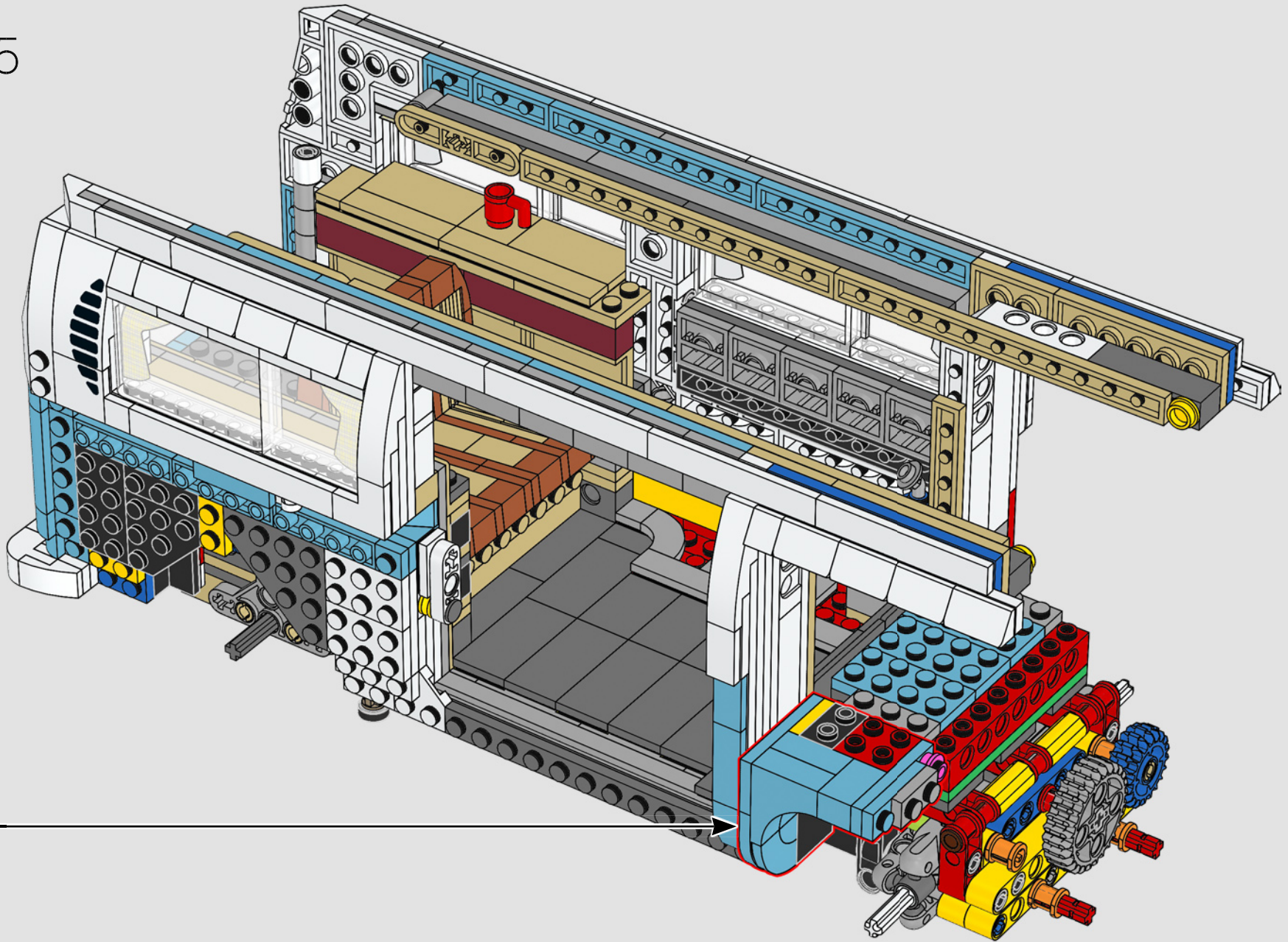

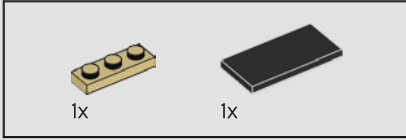
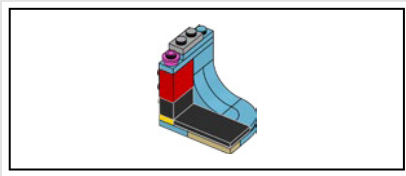

206

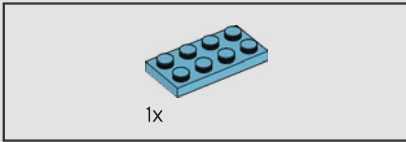
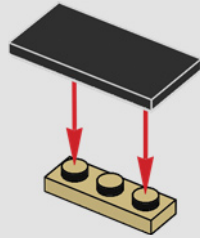

207

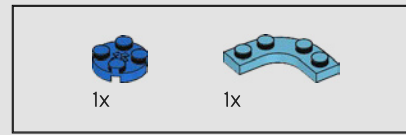
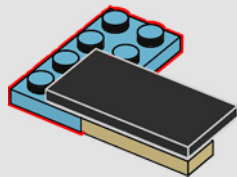

208

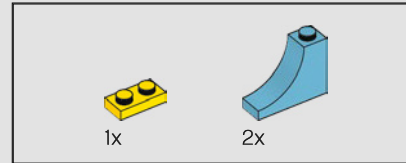
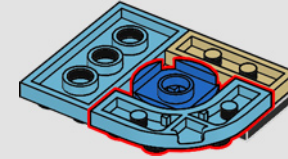

209

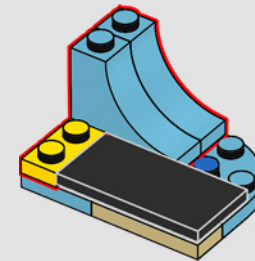

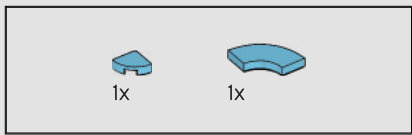

210

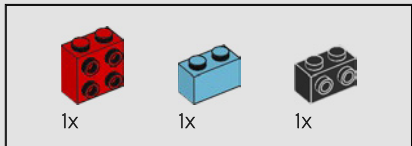
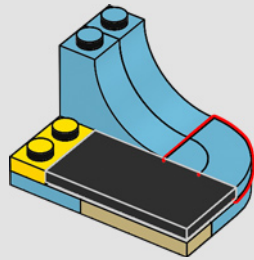

211

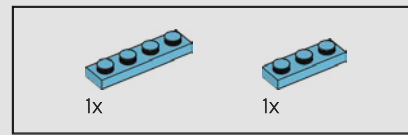
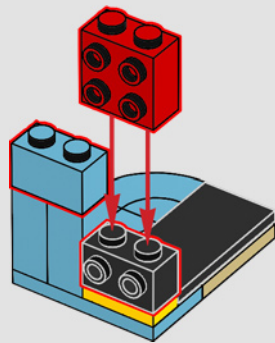

212

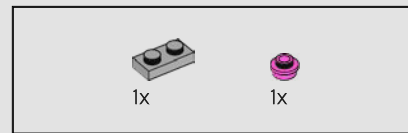
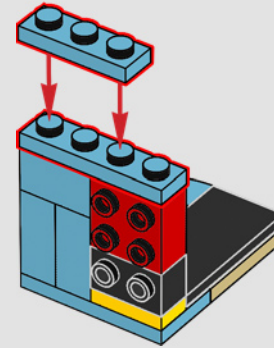

213

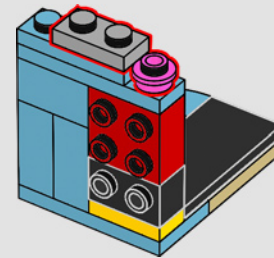

214

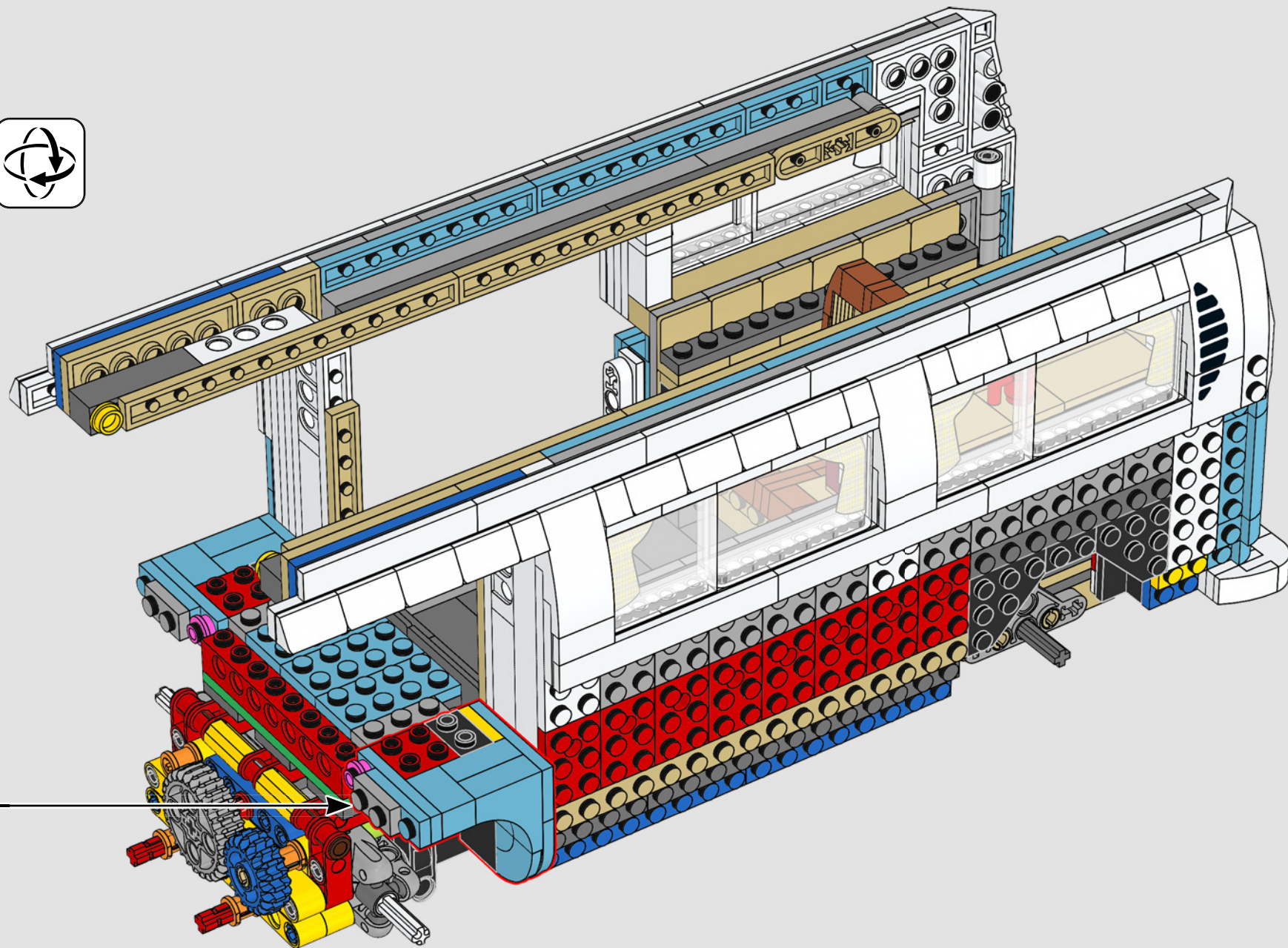

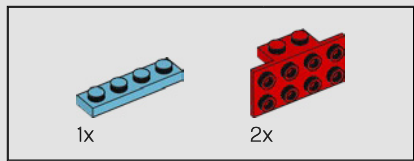

215

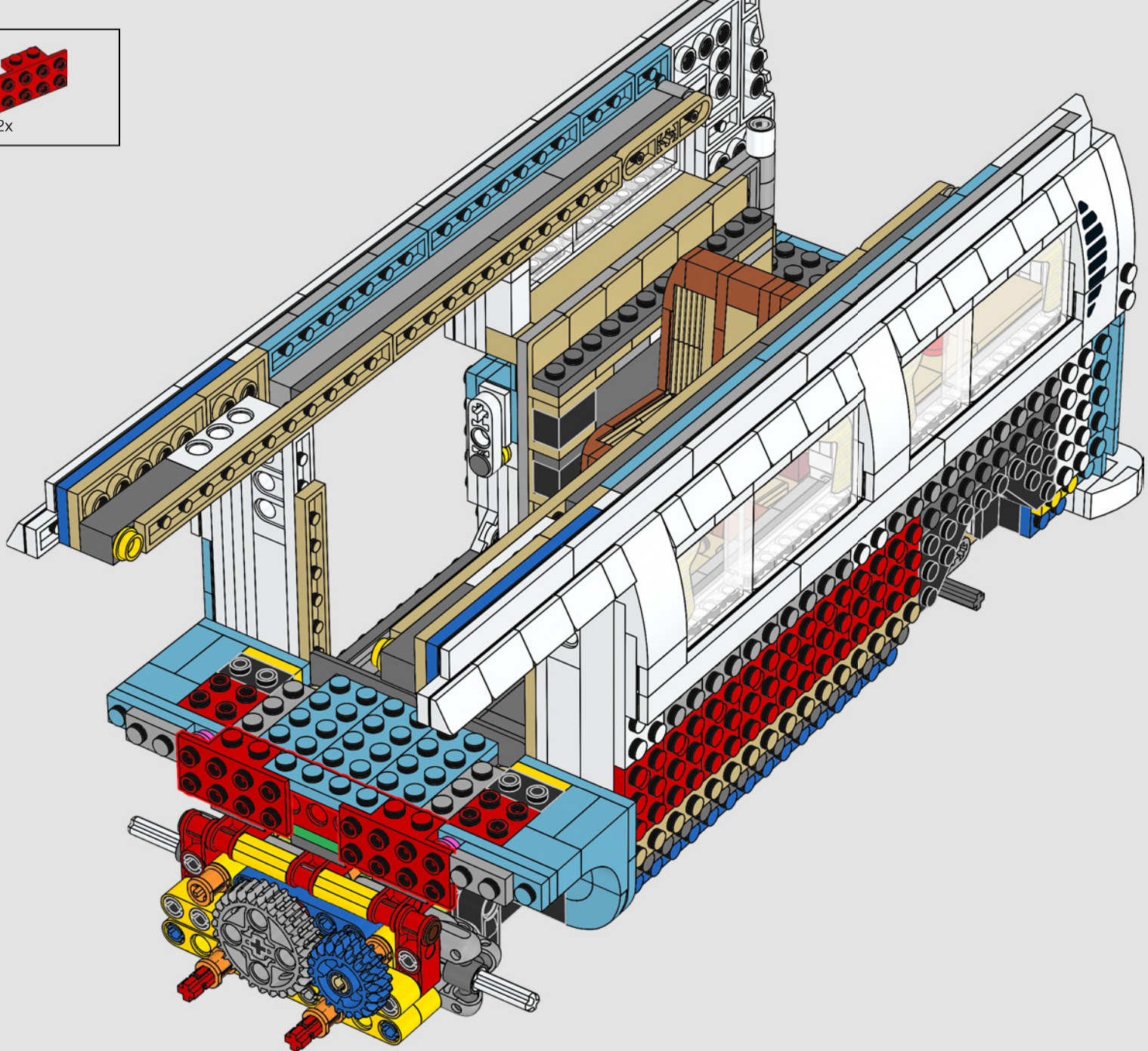

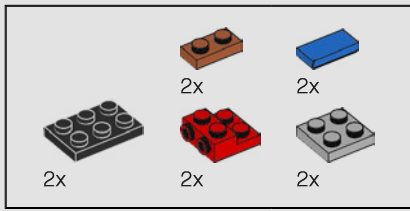

216

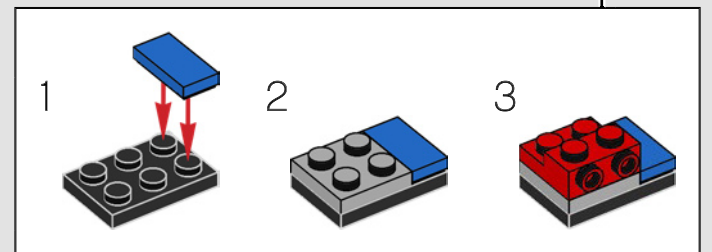
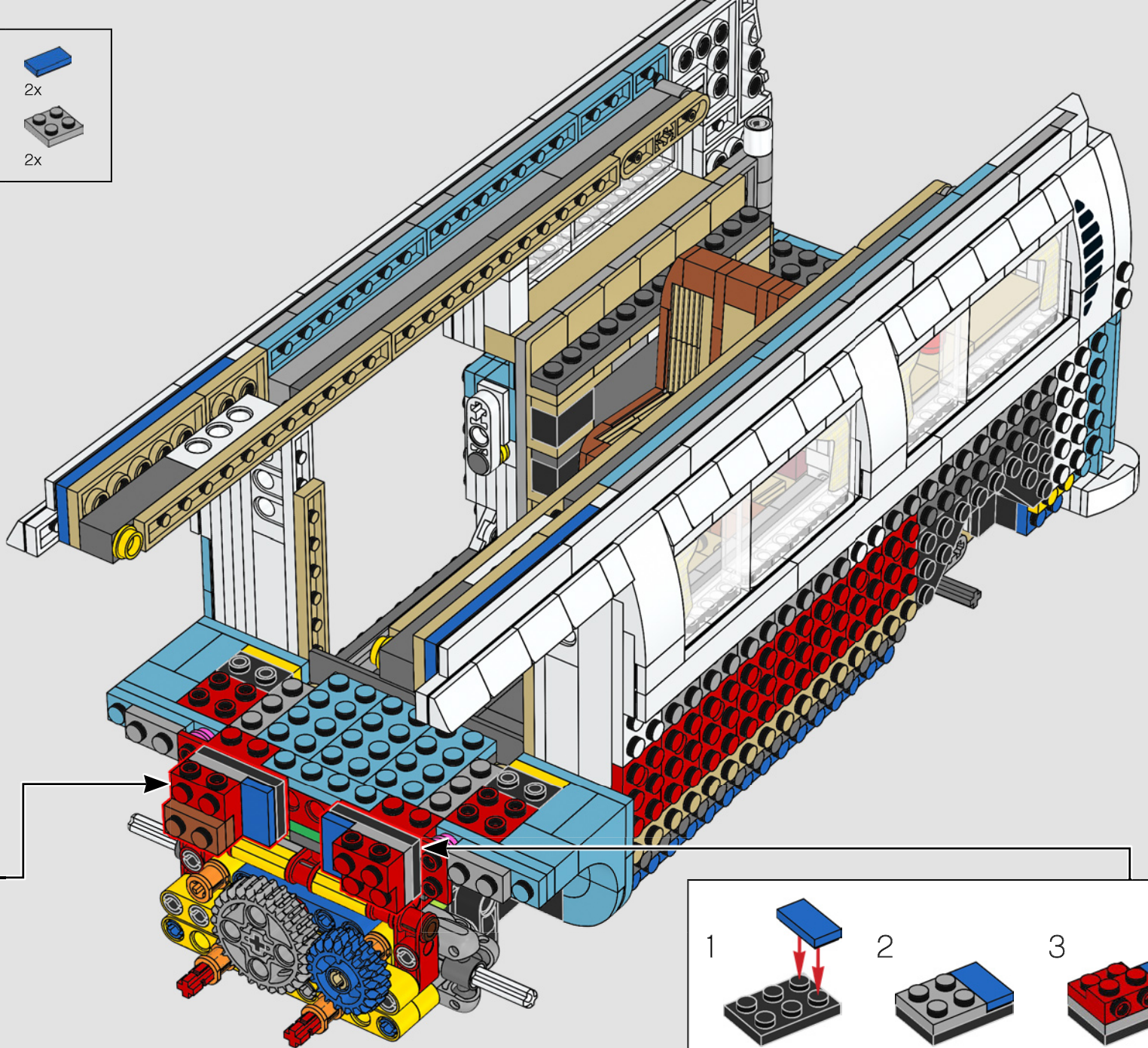
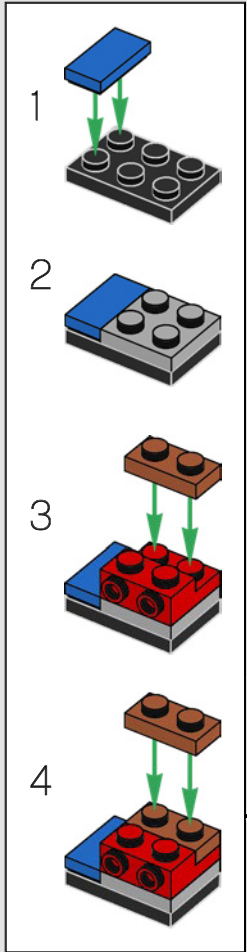

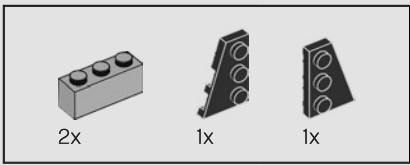

217

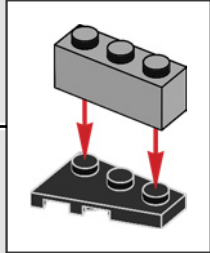
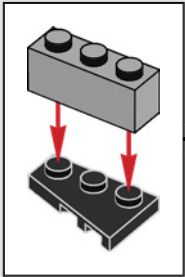
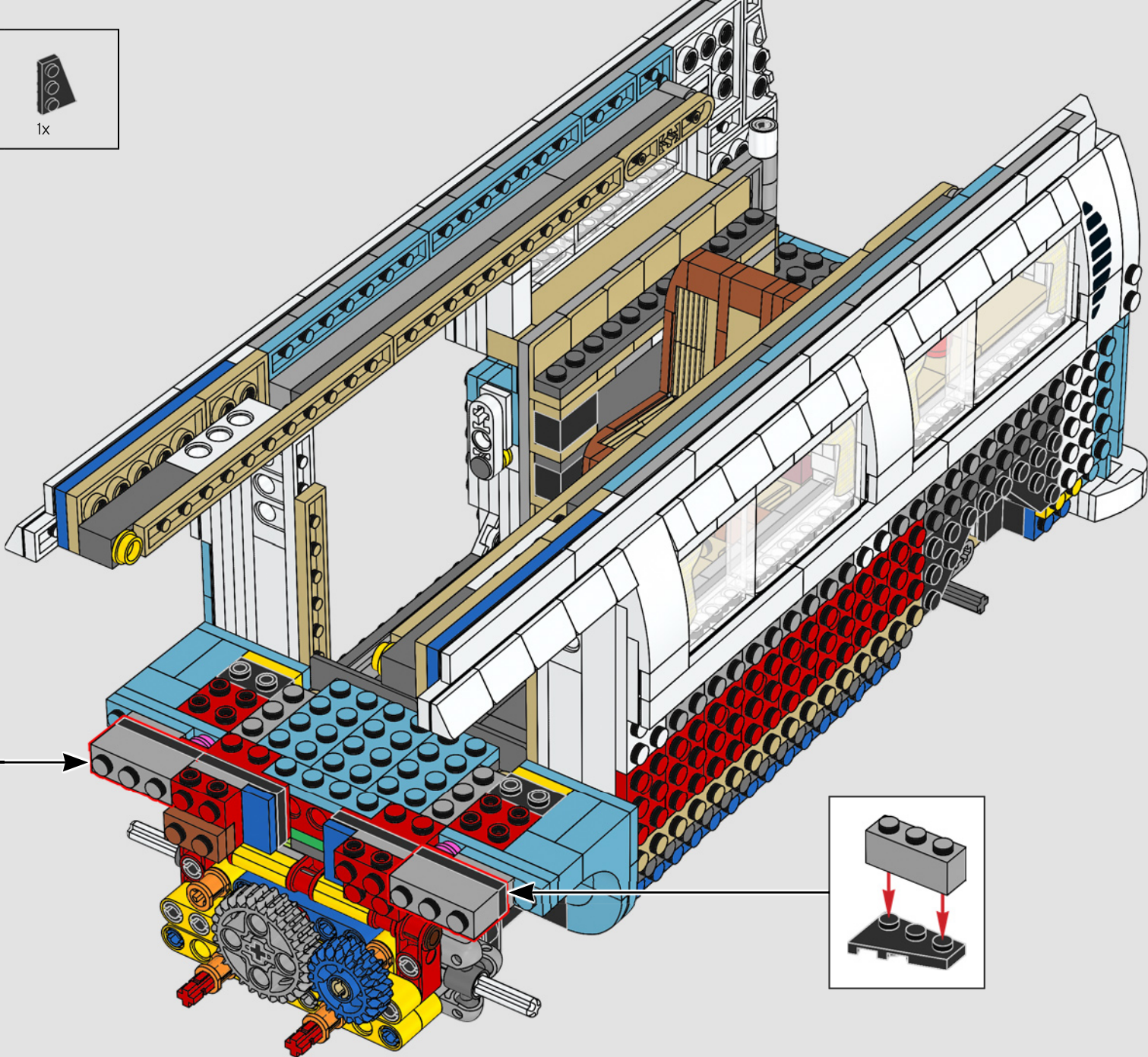

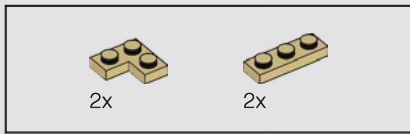

218

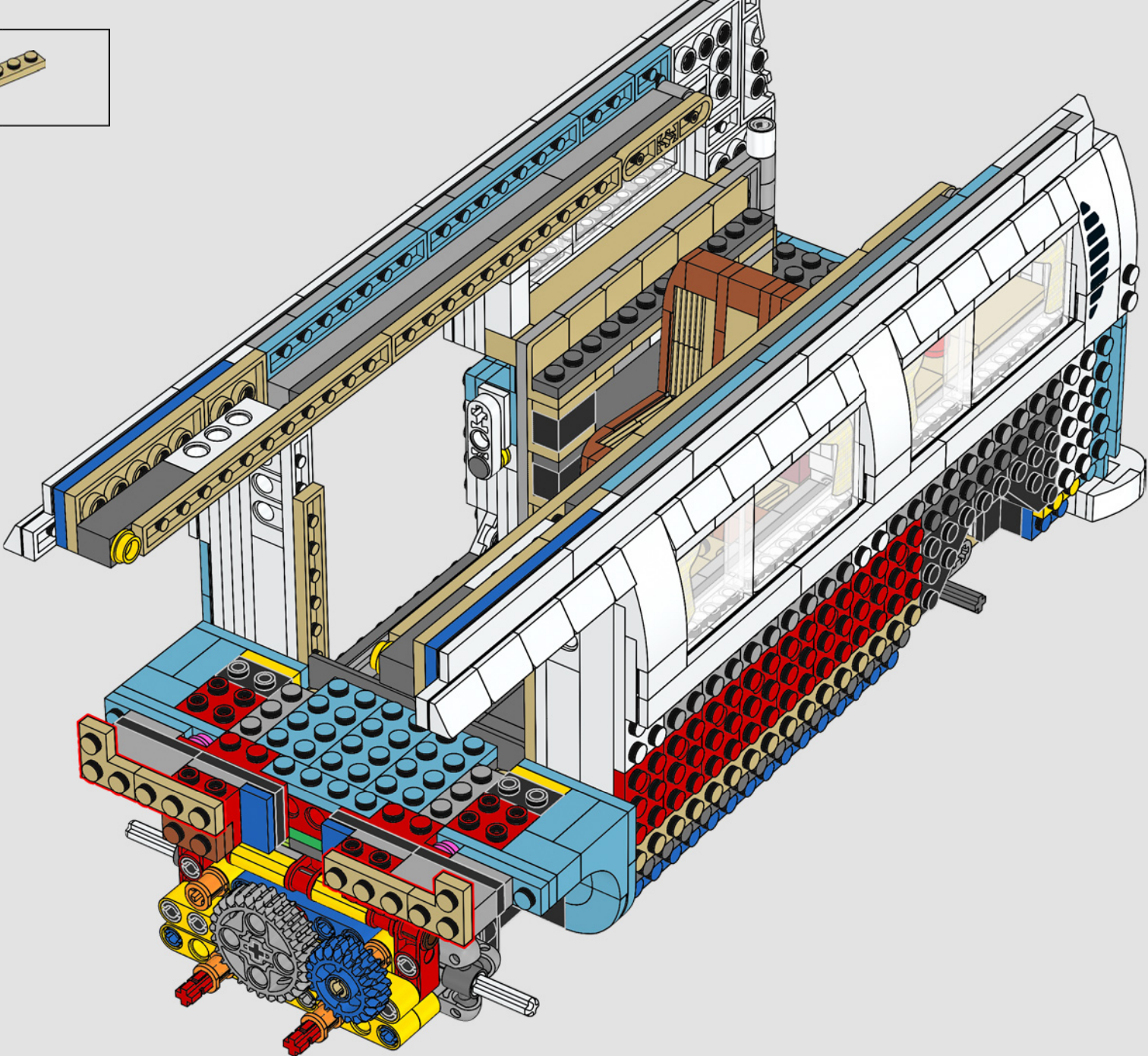

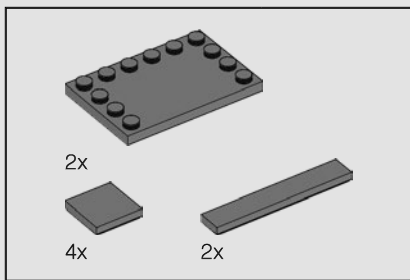

219

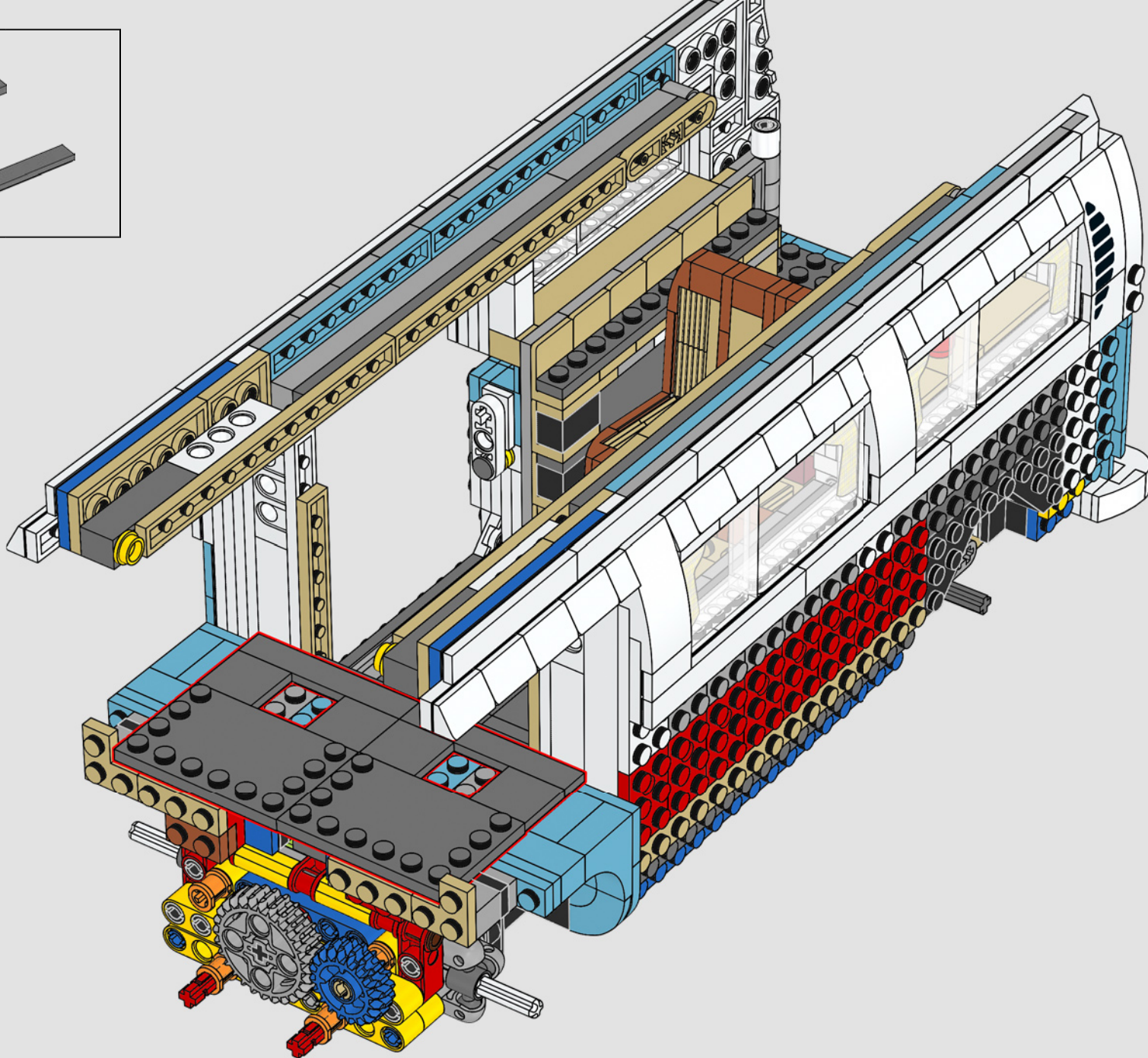

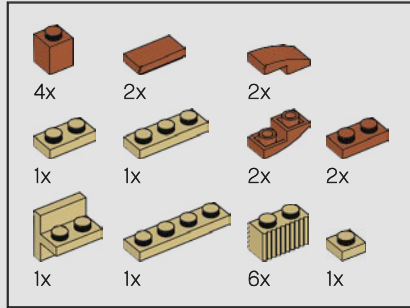
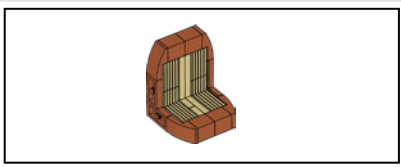

220

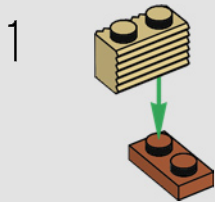

2

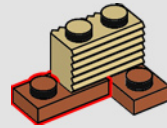

3

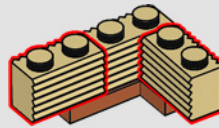

4

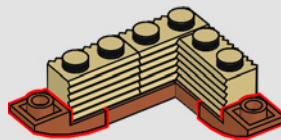

5

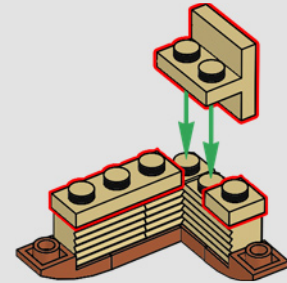

6

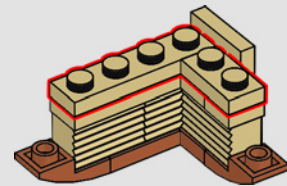

7

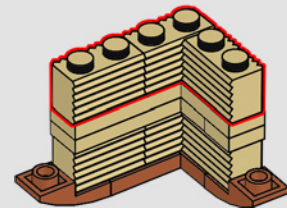

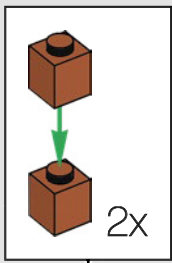

8

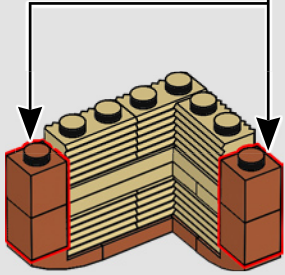

9

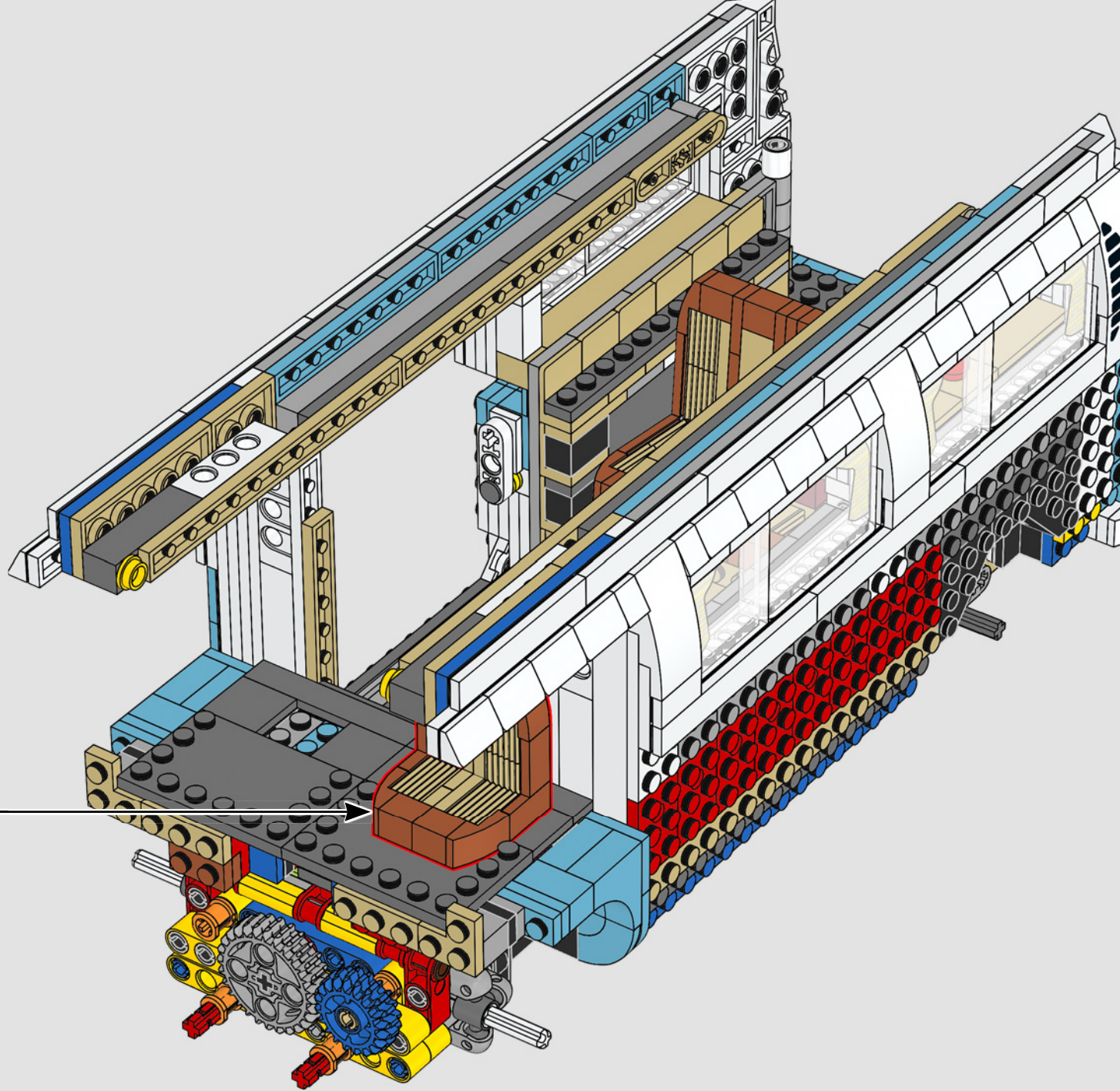
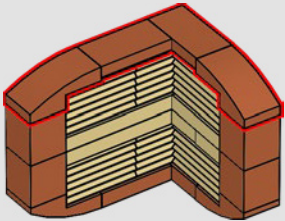

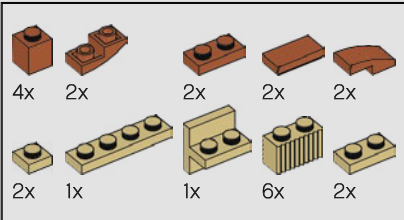
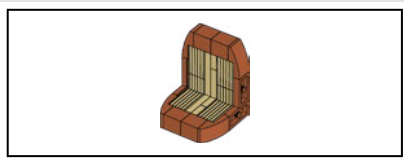

221

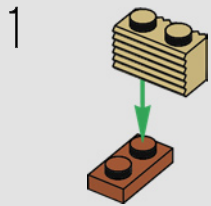

2

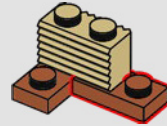

3

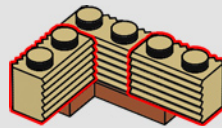

4

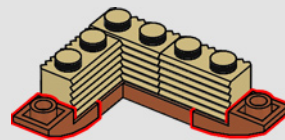

5

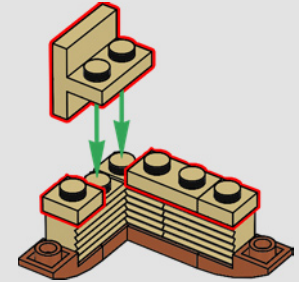

6

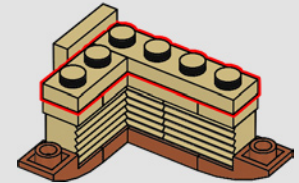

7

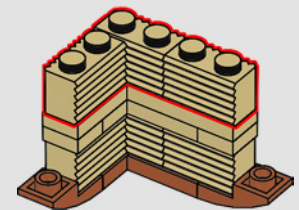

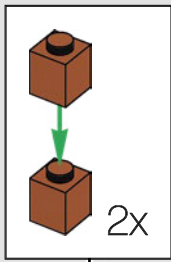

8

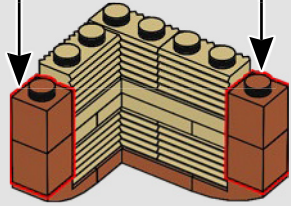

9

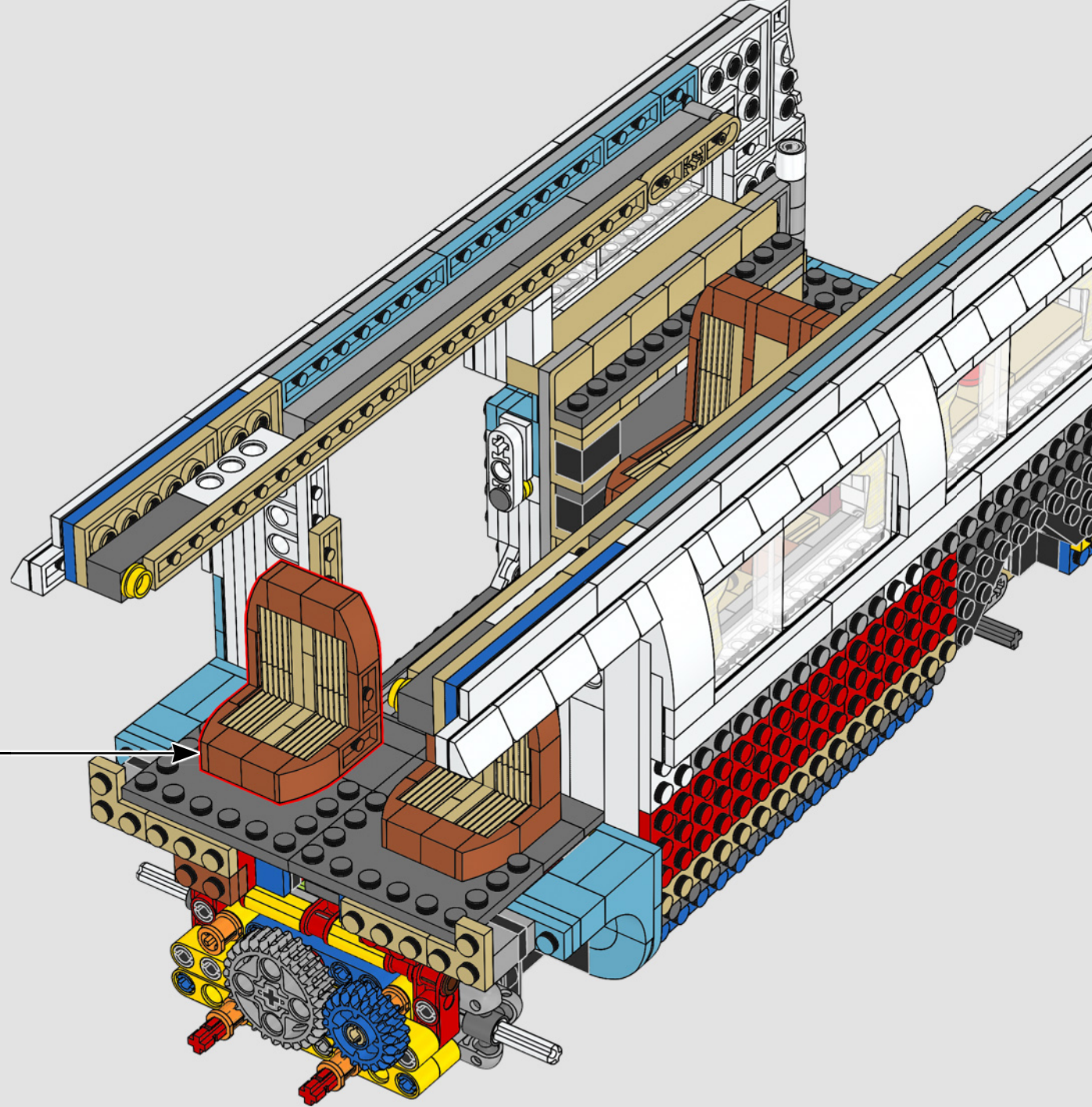
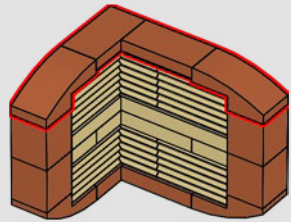

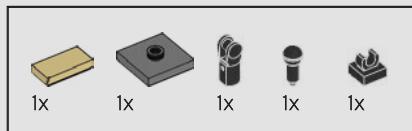

222

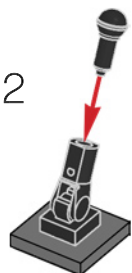
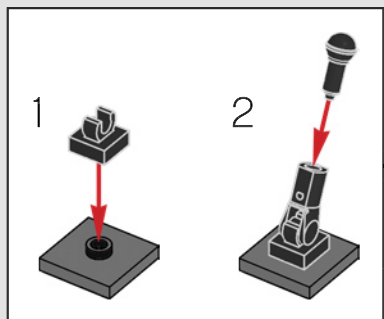
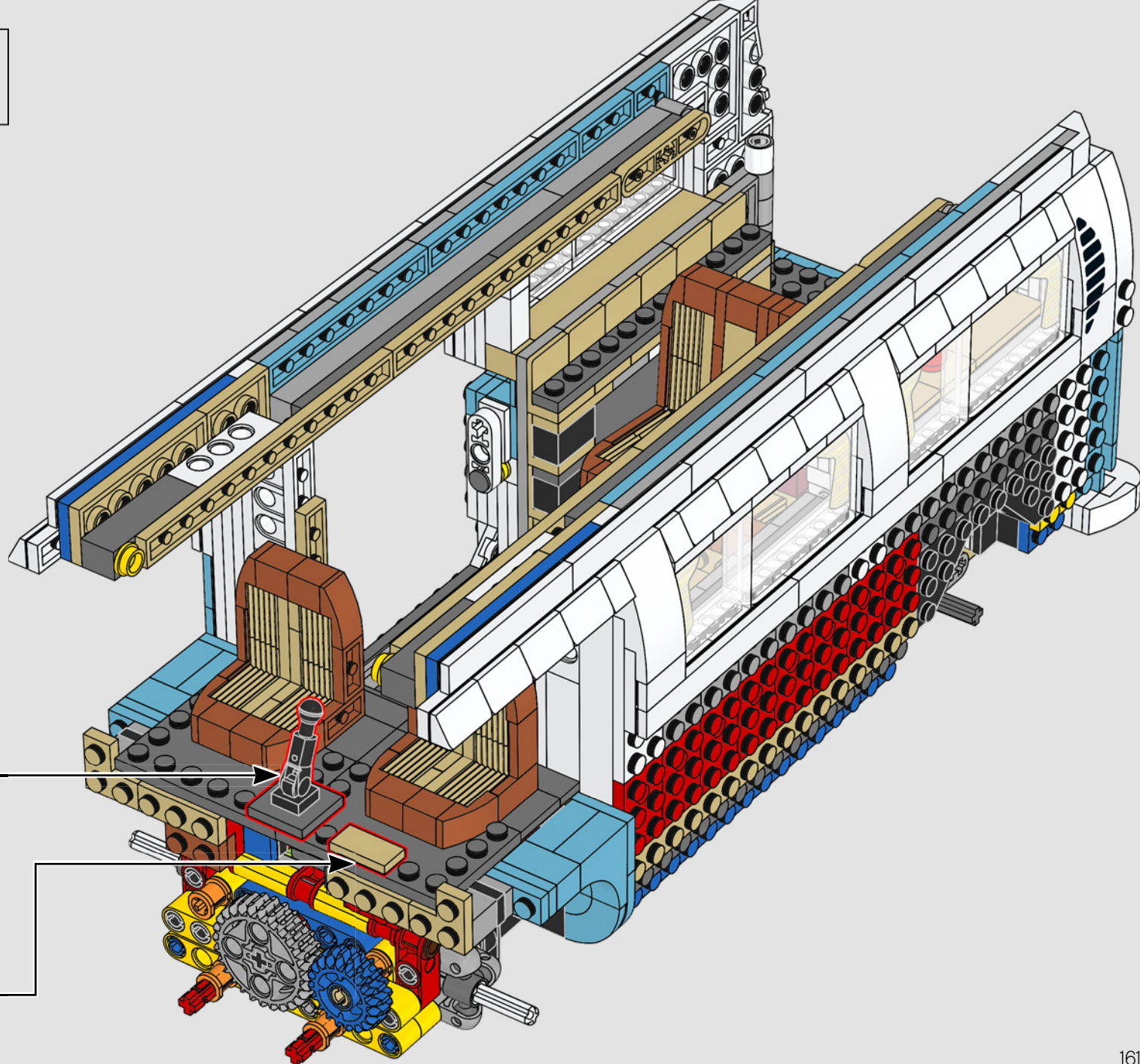

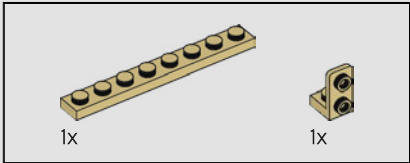
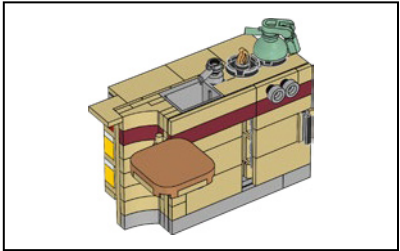
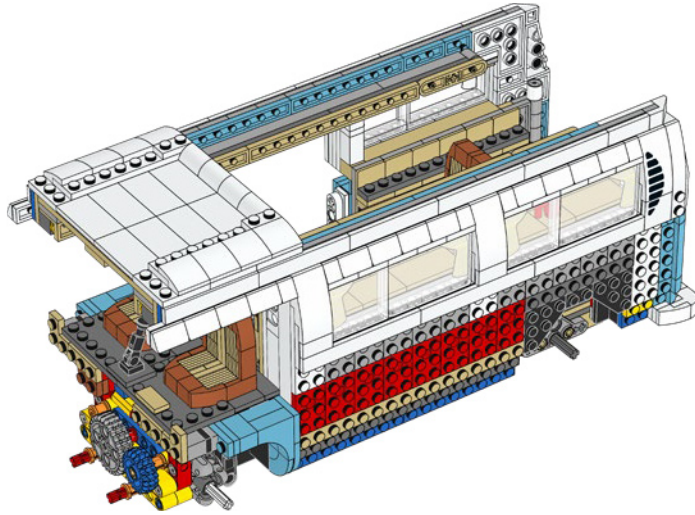
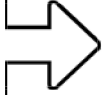

223

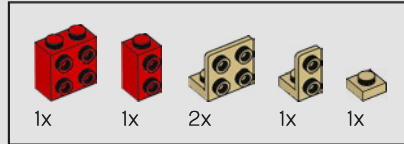
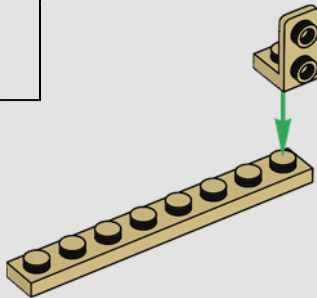

224

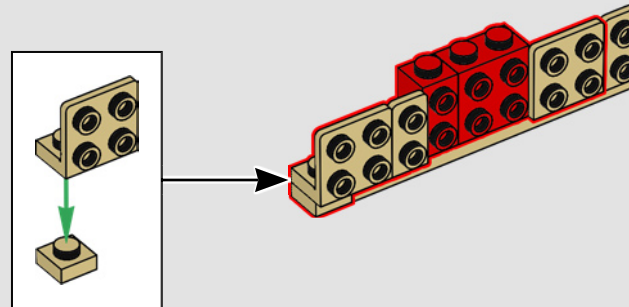

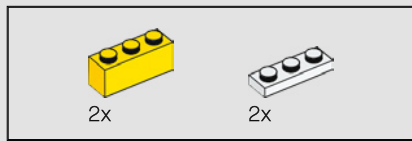

225

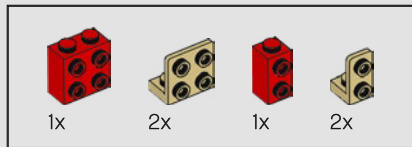
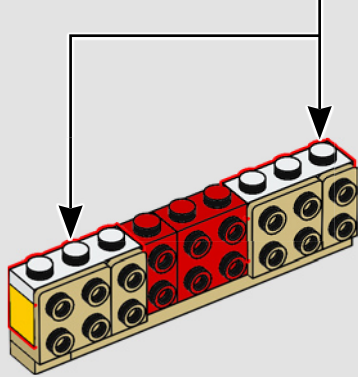
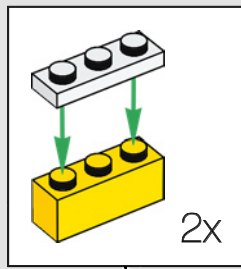

226

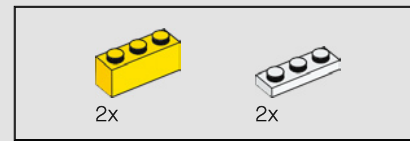
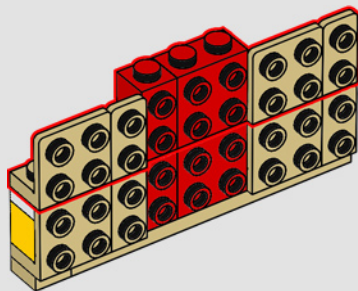

227

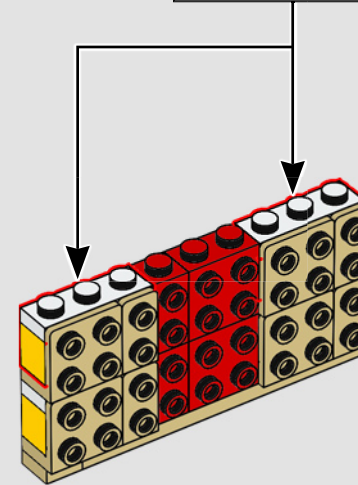
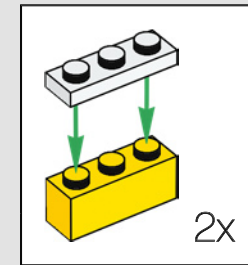

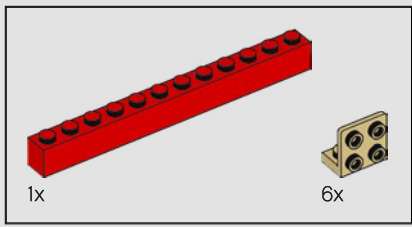

228

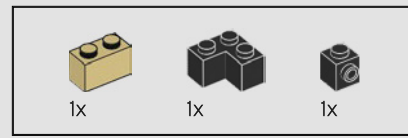
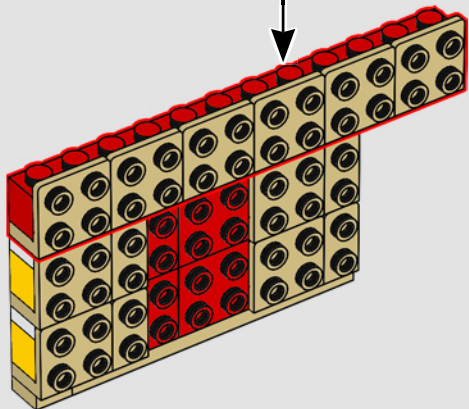
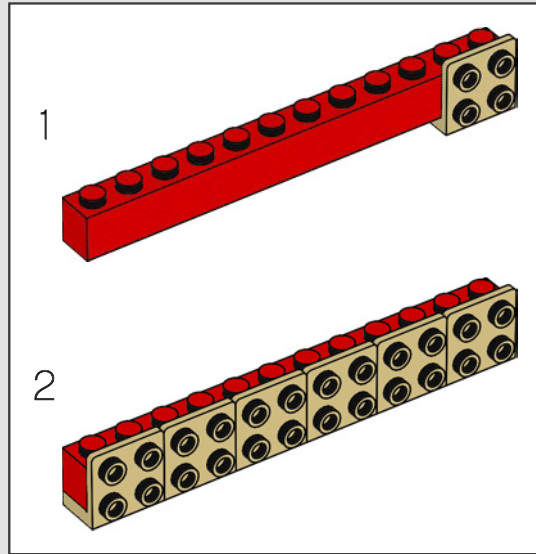

229

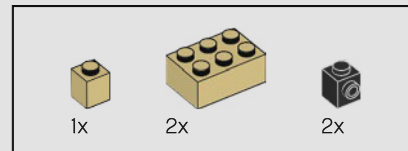
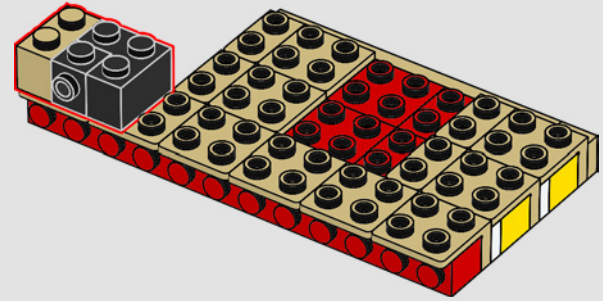
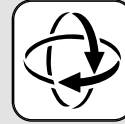

230

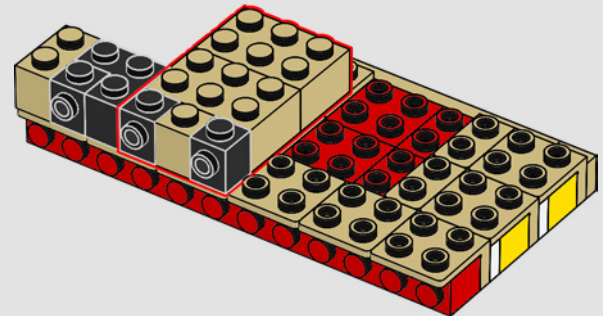

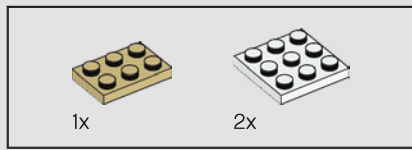

231

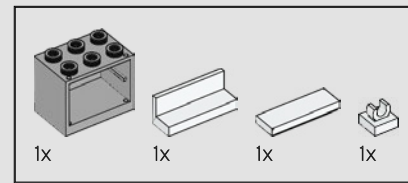
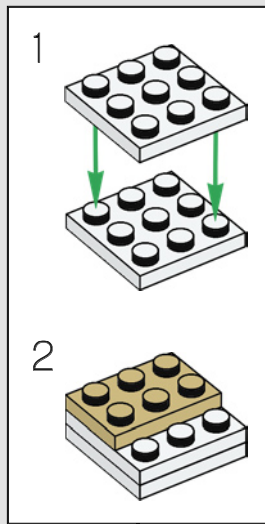
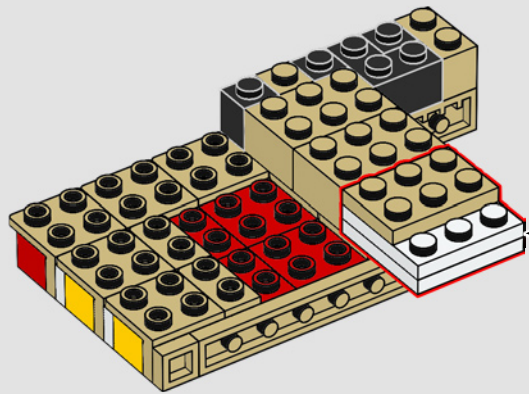

232

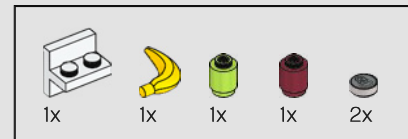
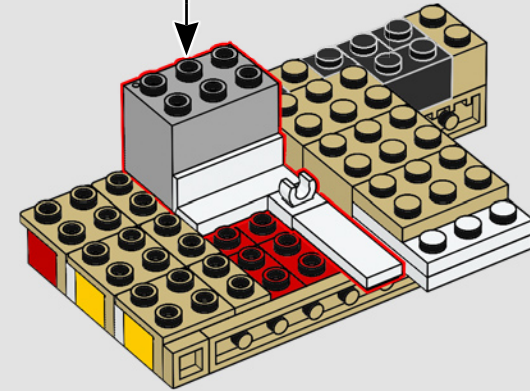
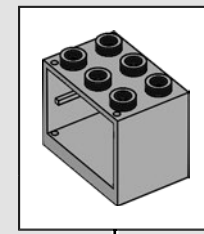

233

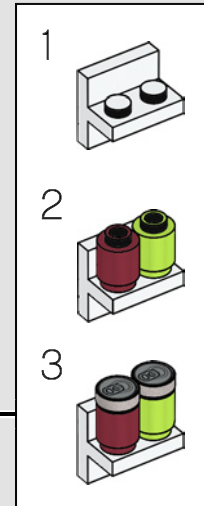
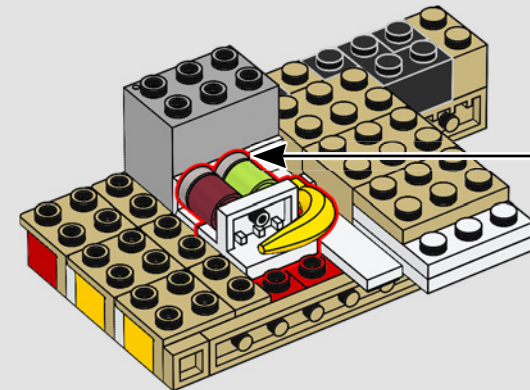

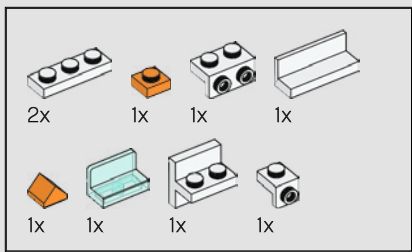

234

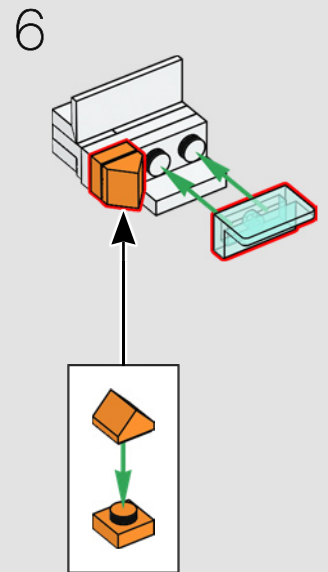
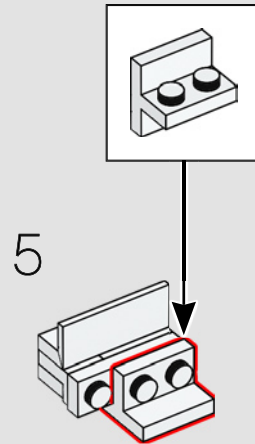
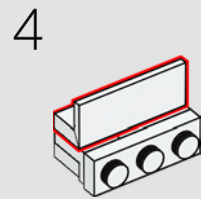
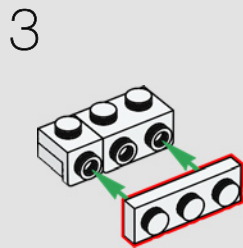
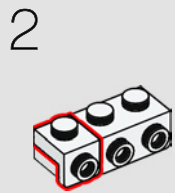
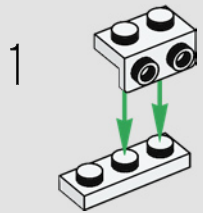

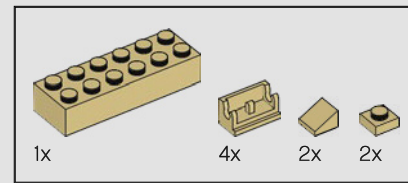
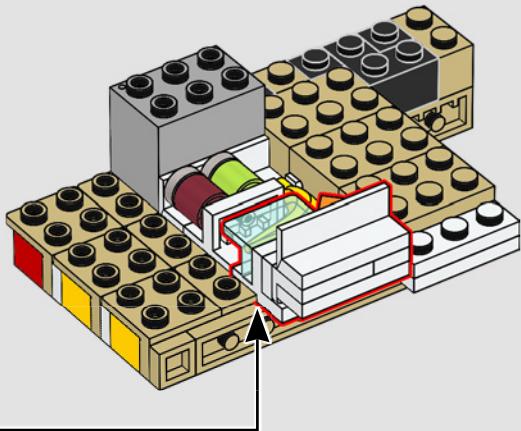

235

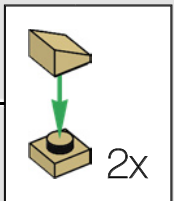
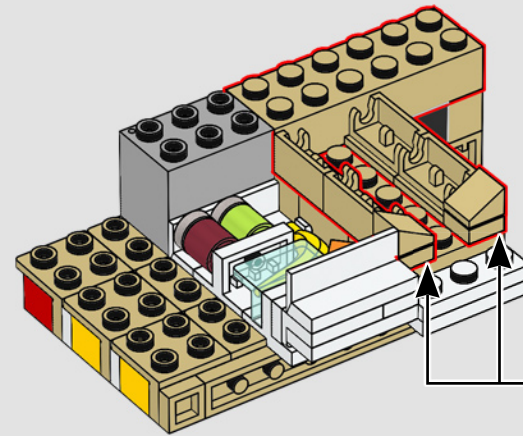

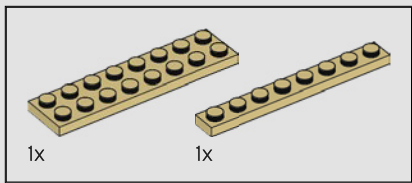

236

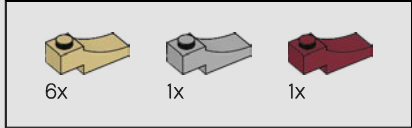
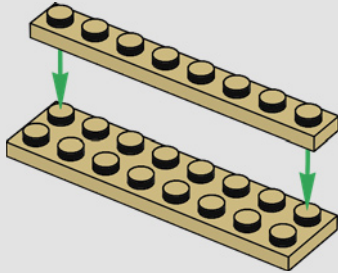

237

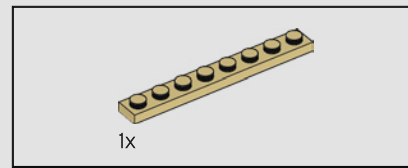
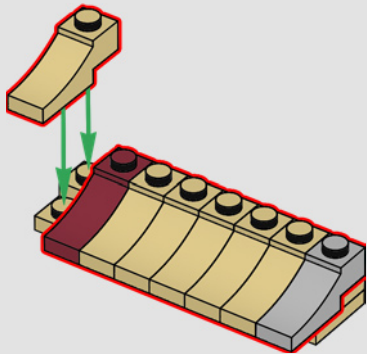

238

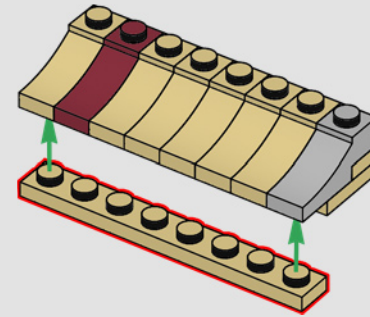

239

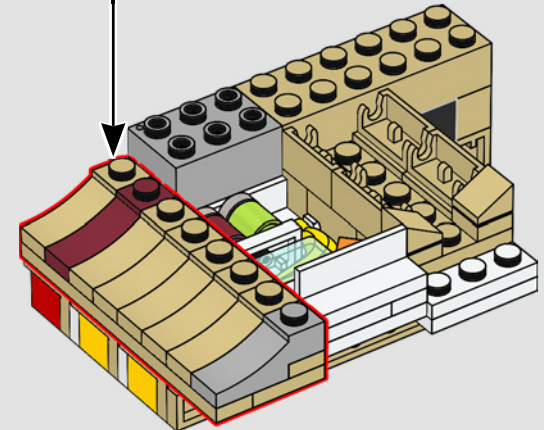

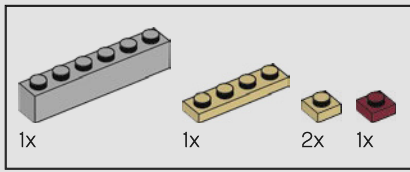

240

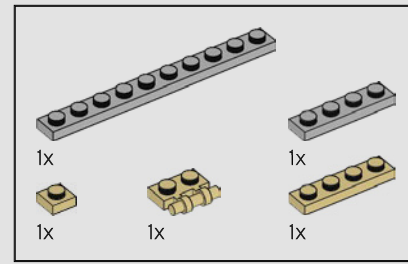
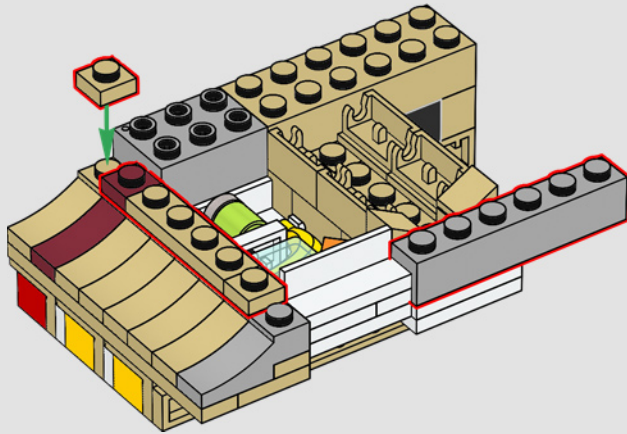

241

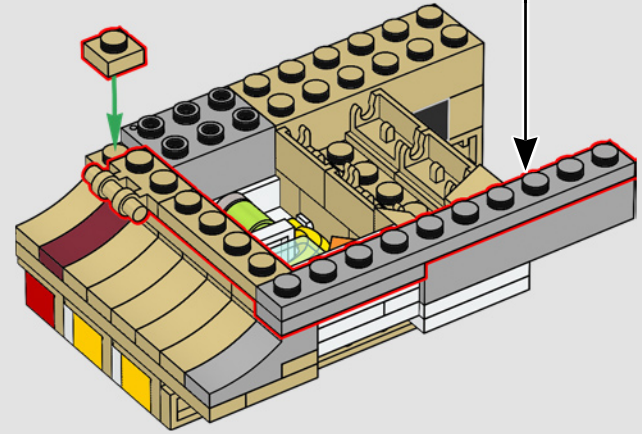
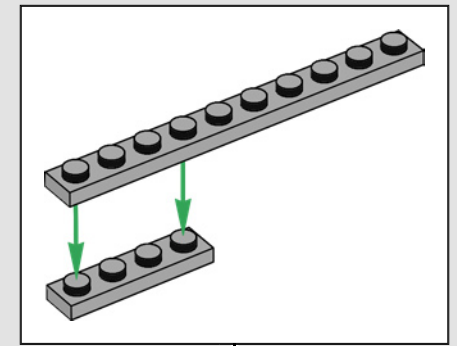

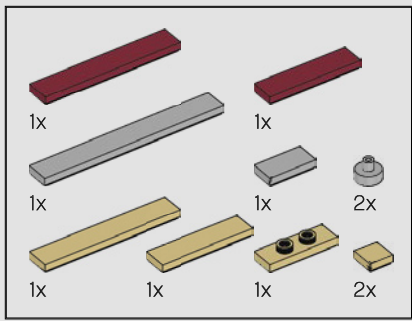

242

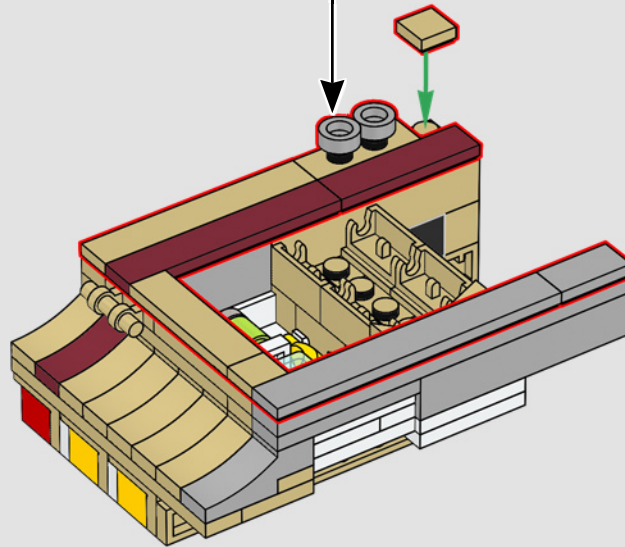
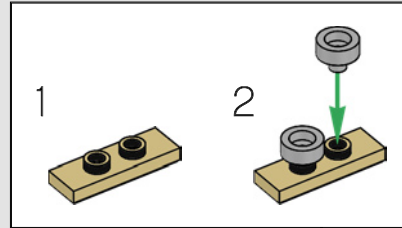

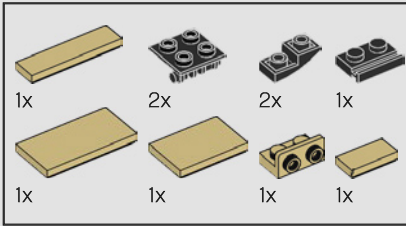
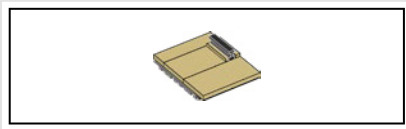

243

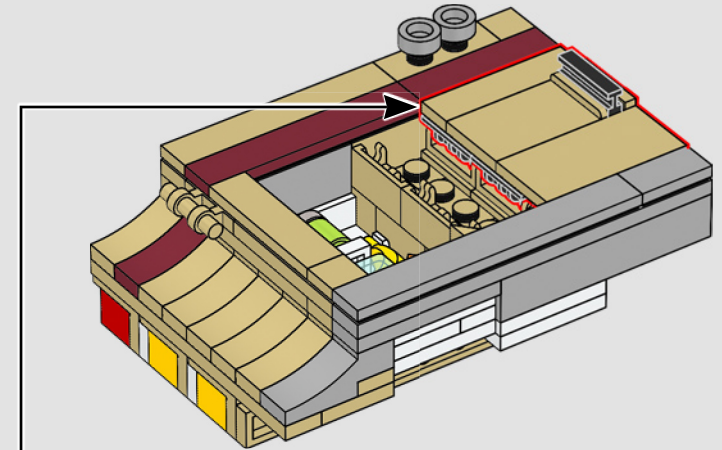
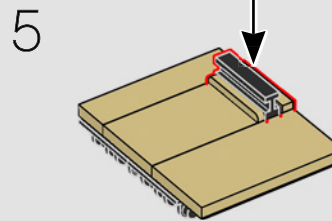
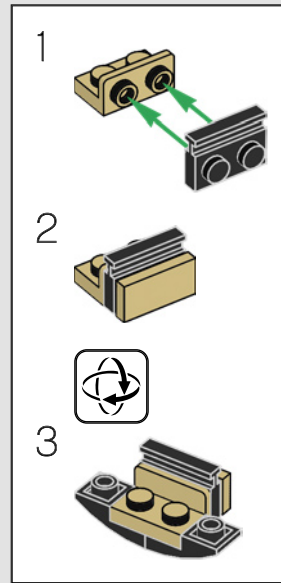
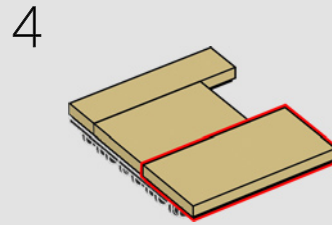
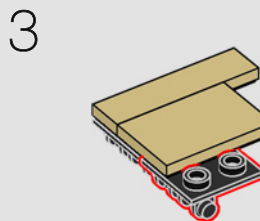
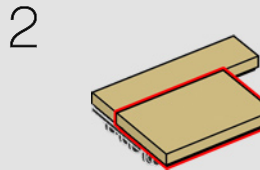
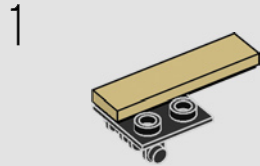

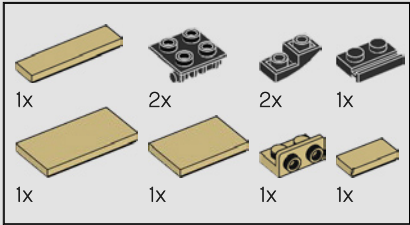
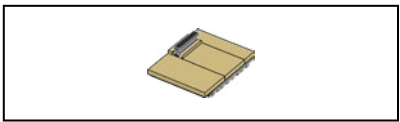

244

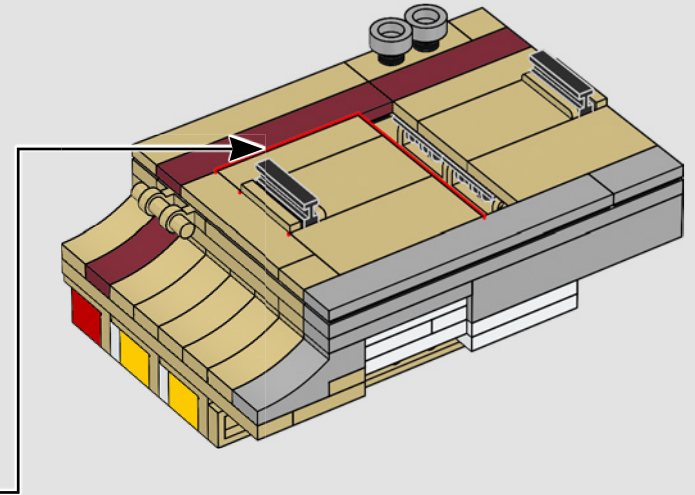
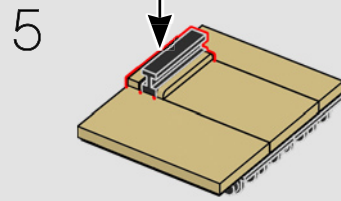
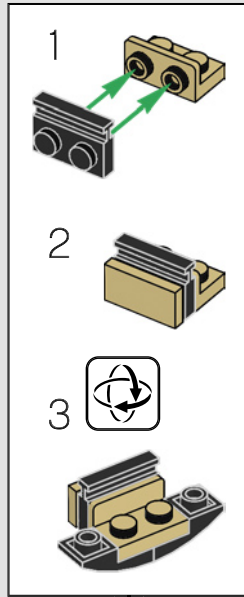
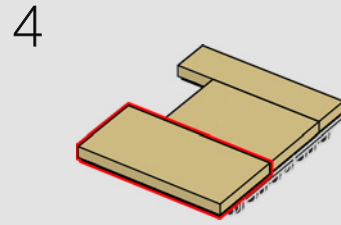
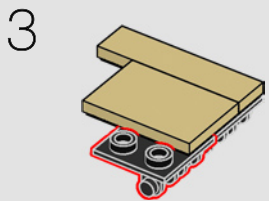
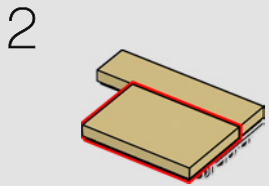
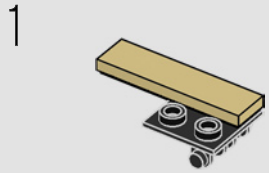

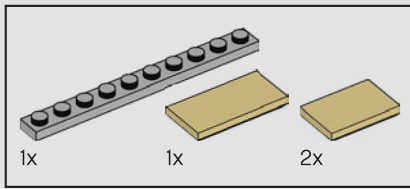

245

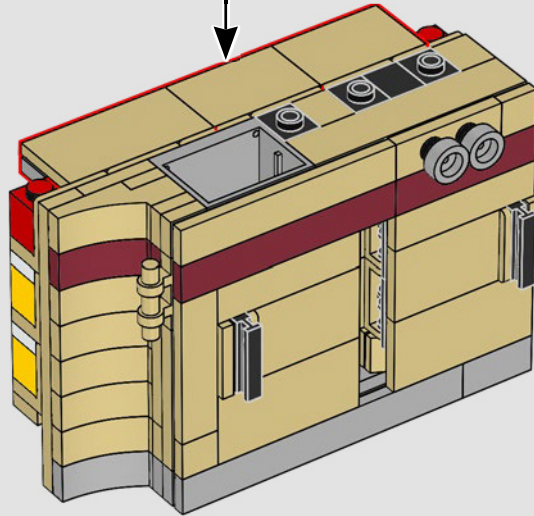
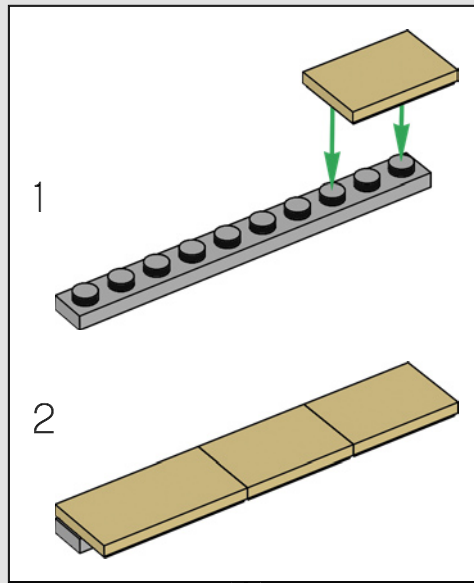

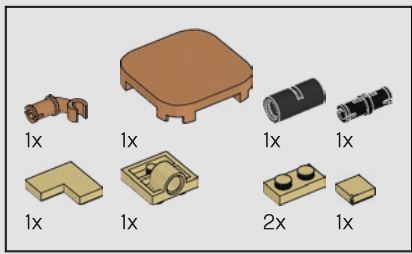

246

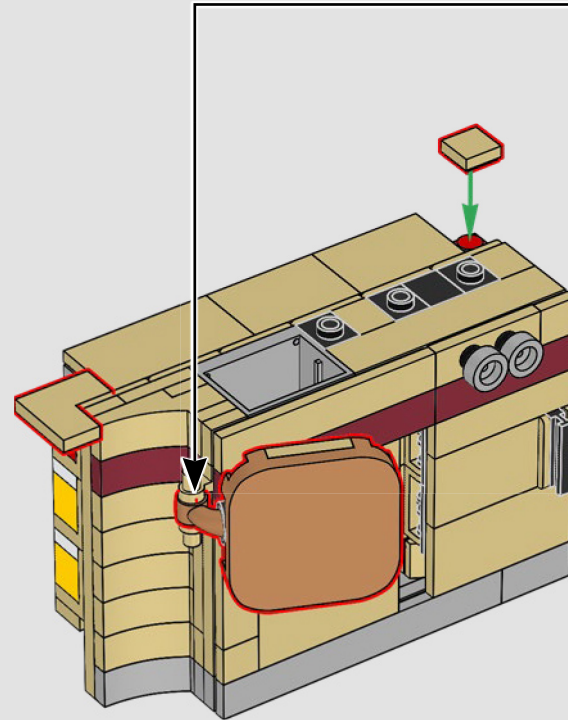
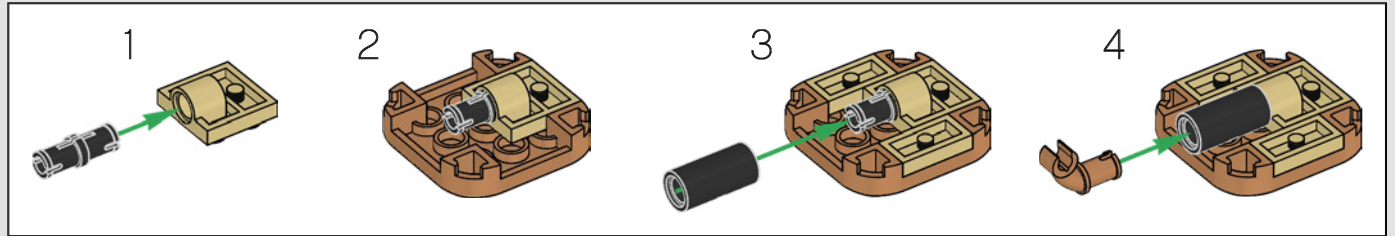

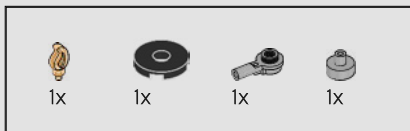

247

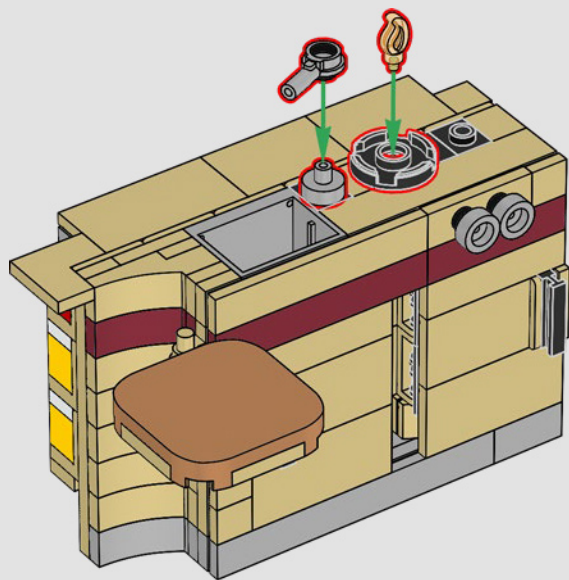

248

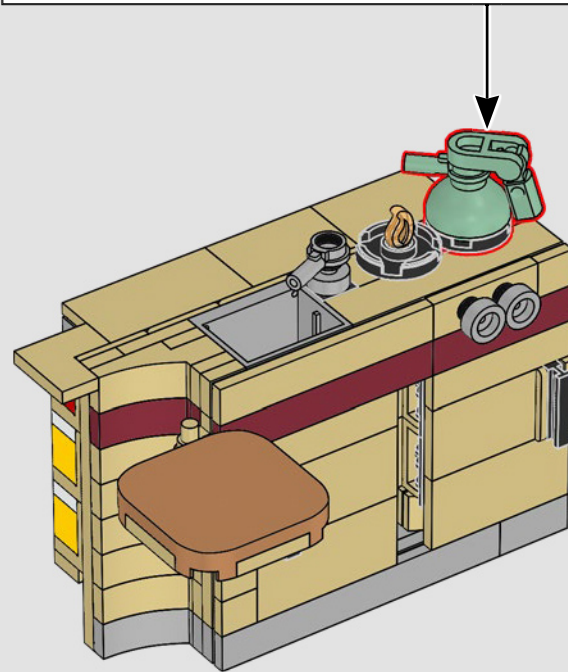
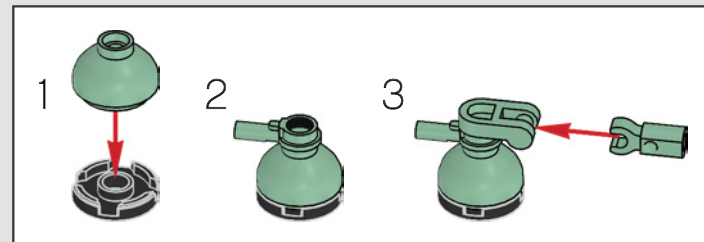

249

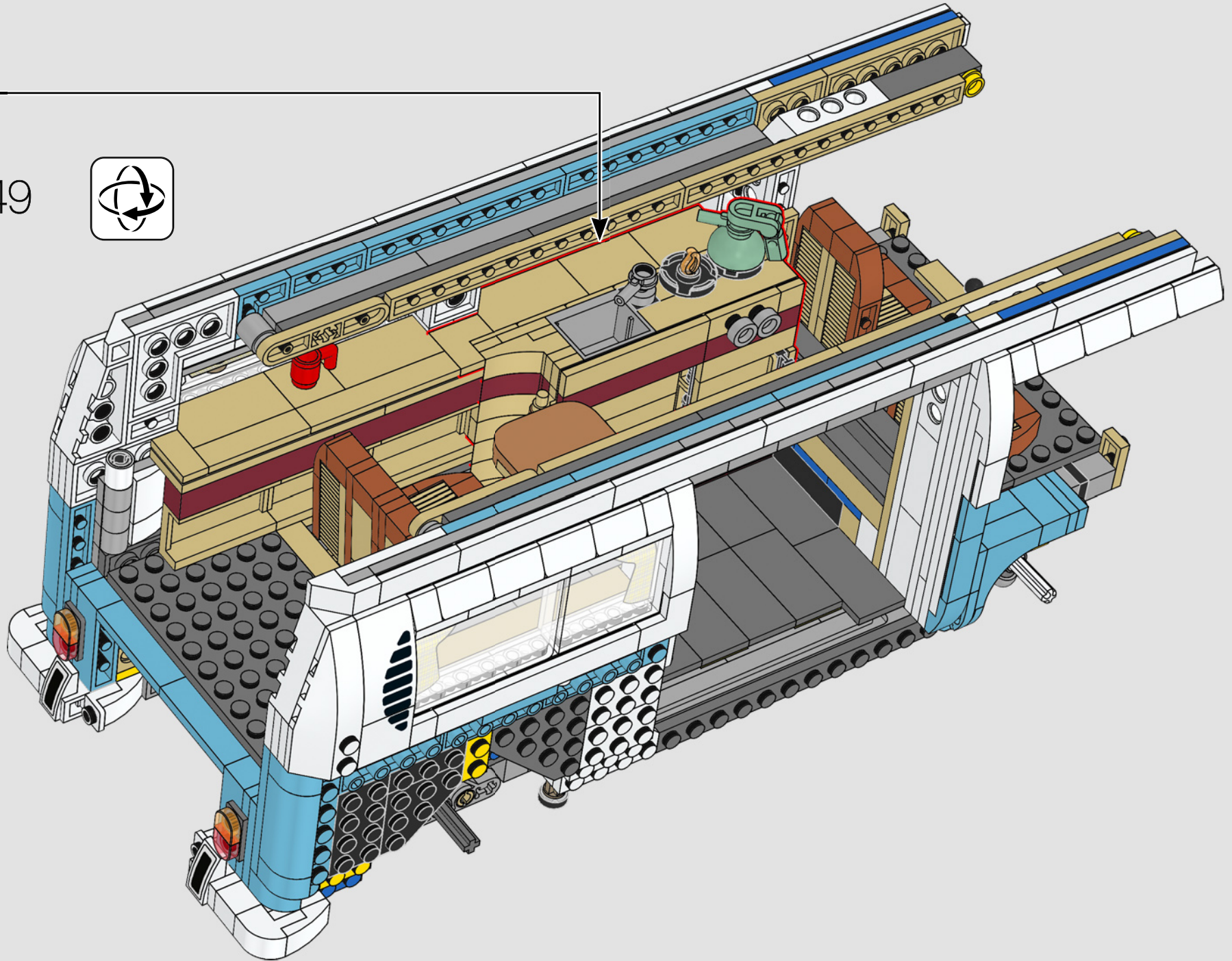

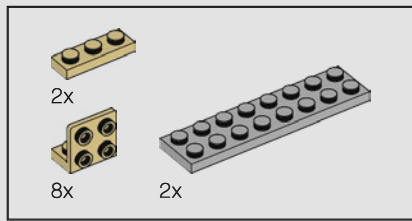

250

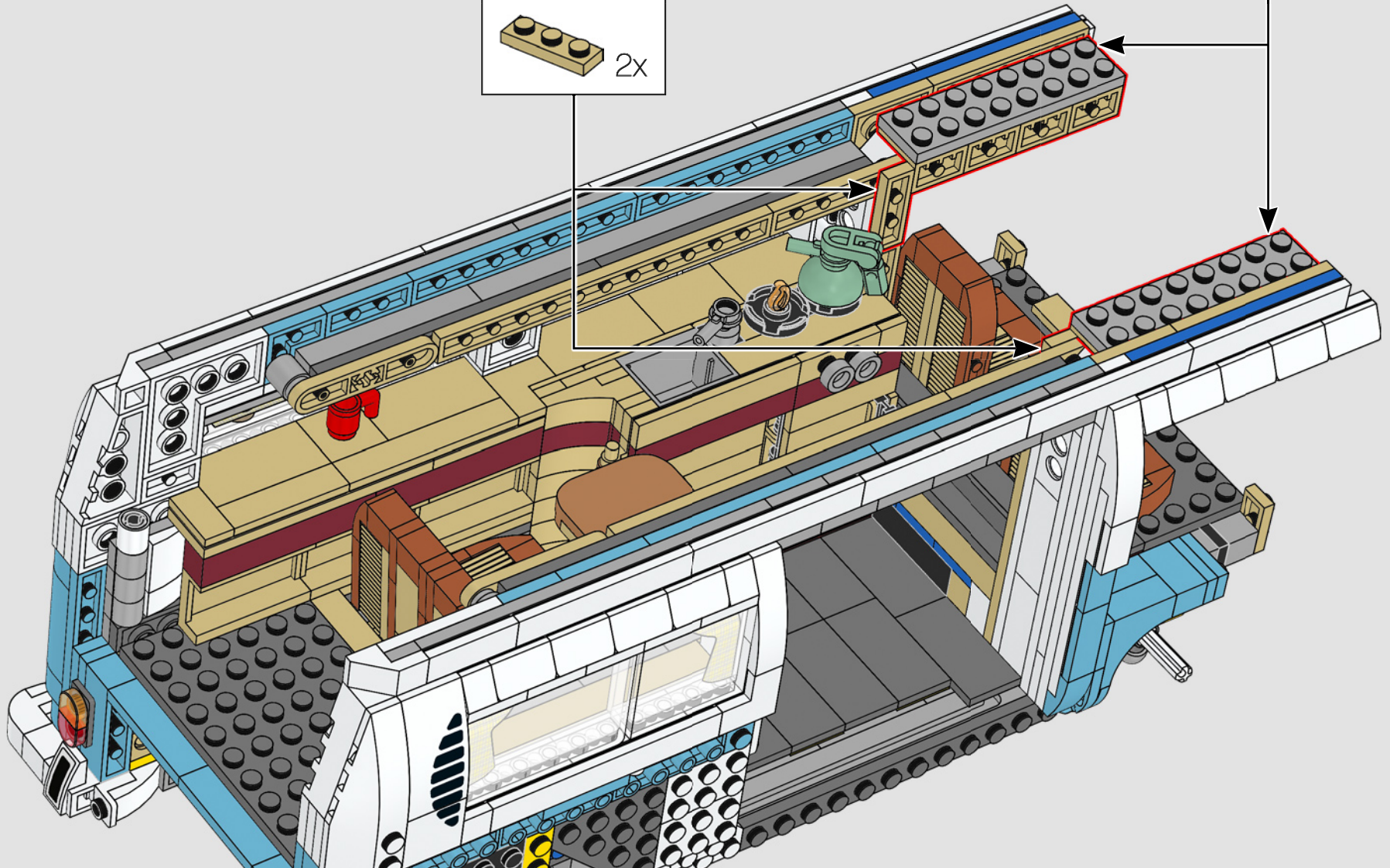
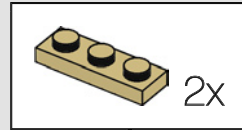
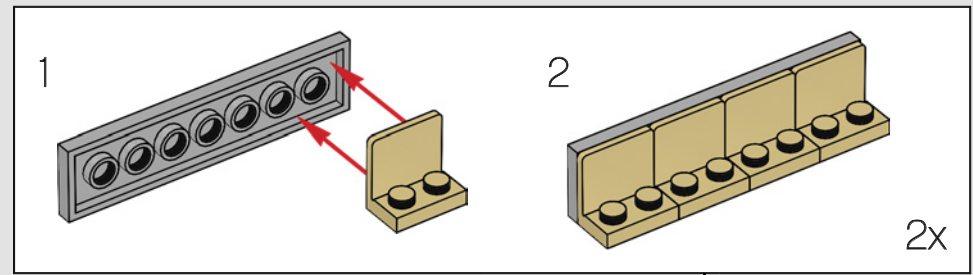

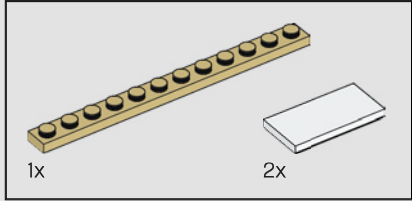
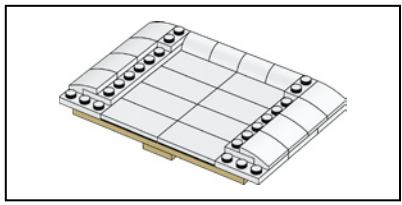

251

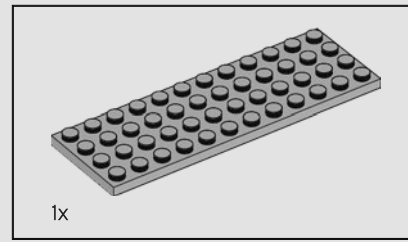
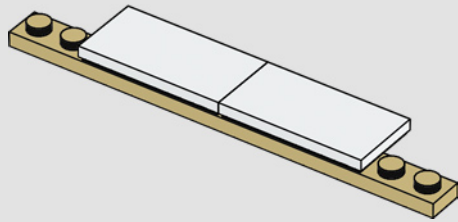

252

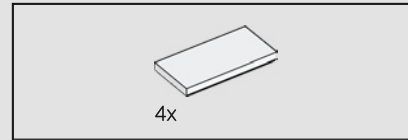
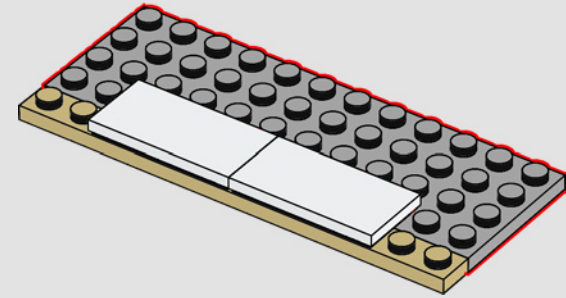

253

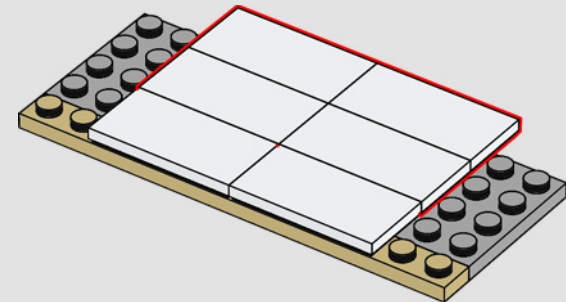

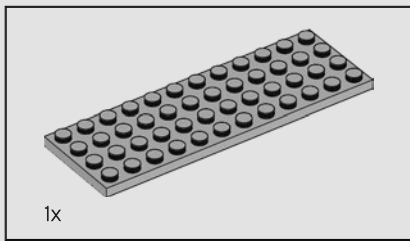

254

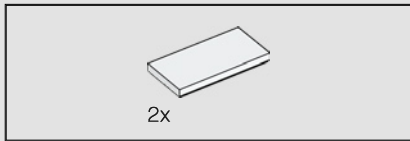
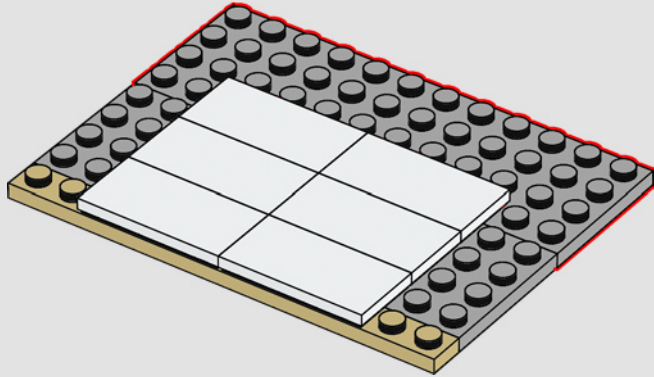

255

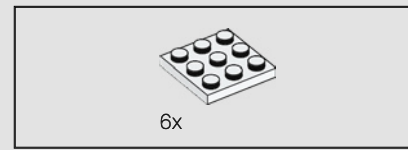
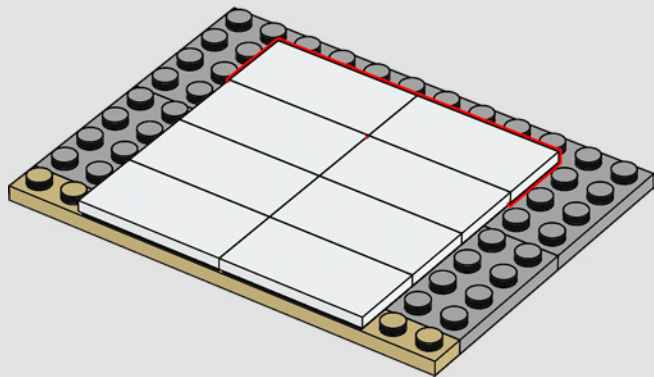

256

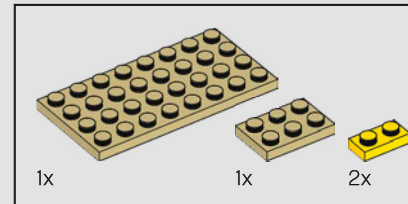
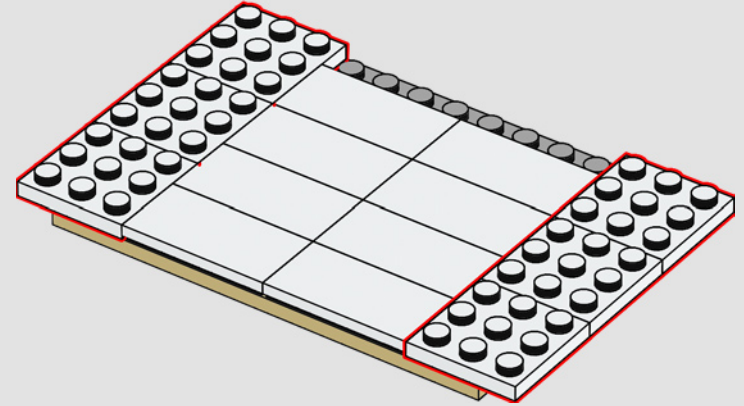

257

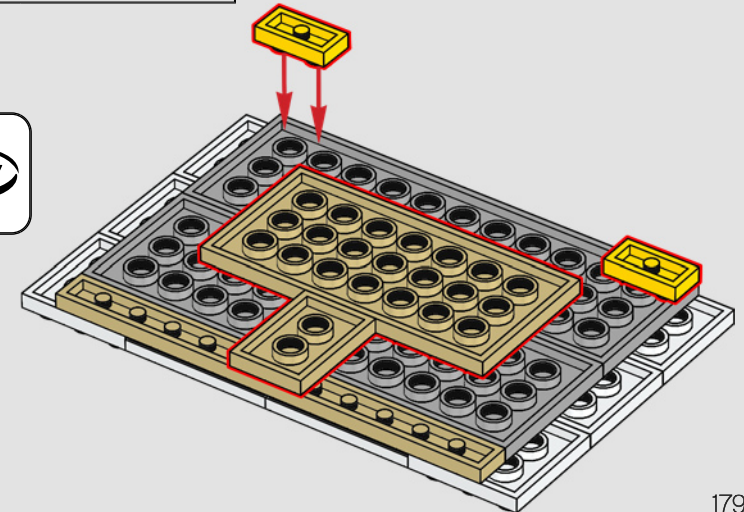
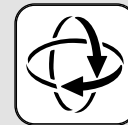

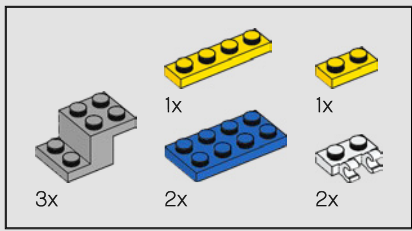

258

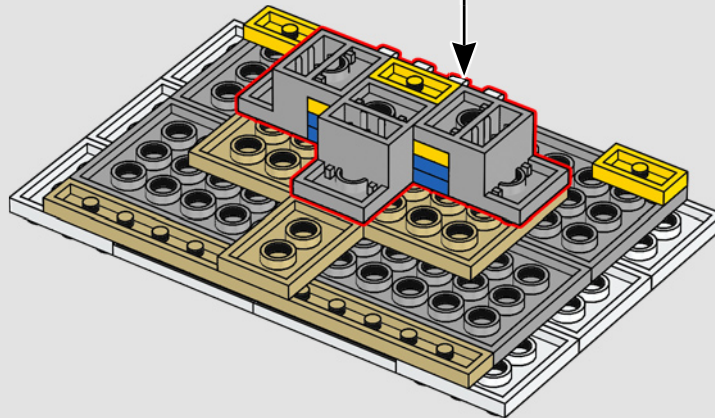
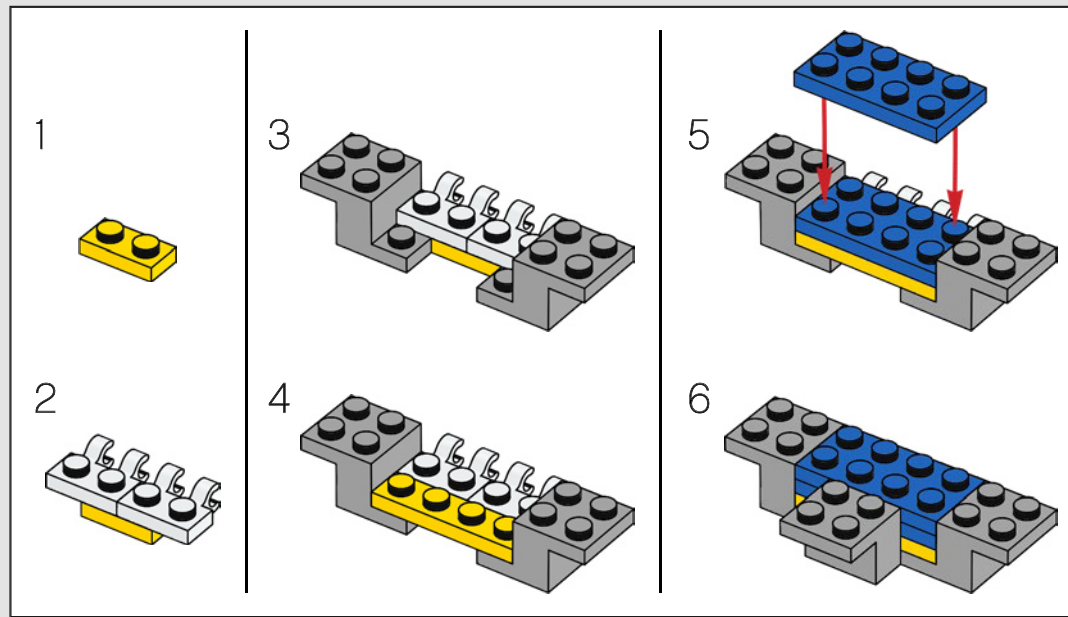

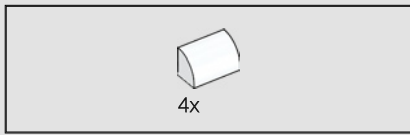

259

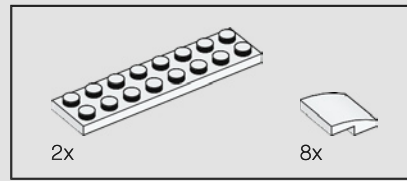
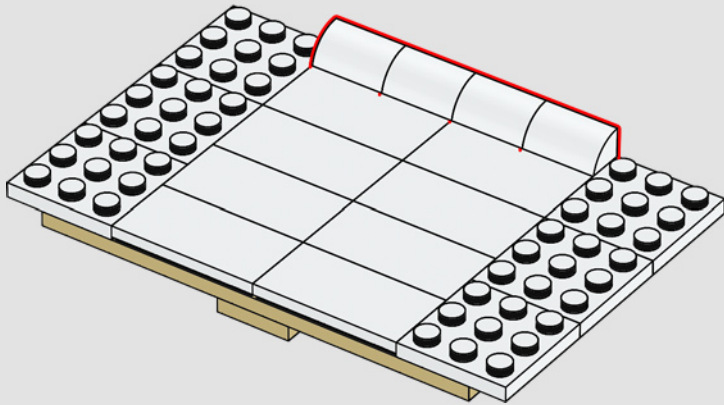

260

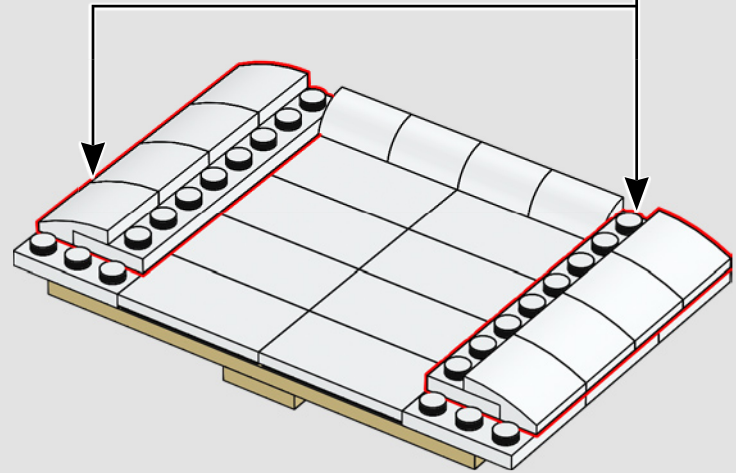
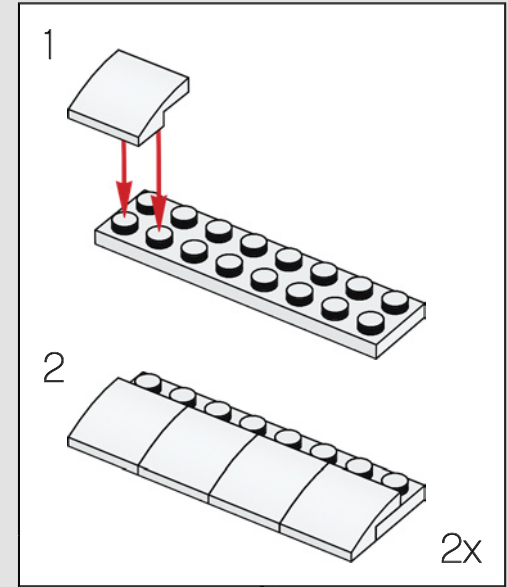



2x

261

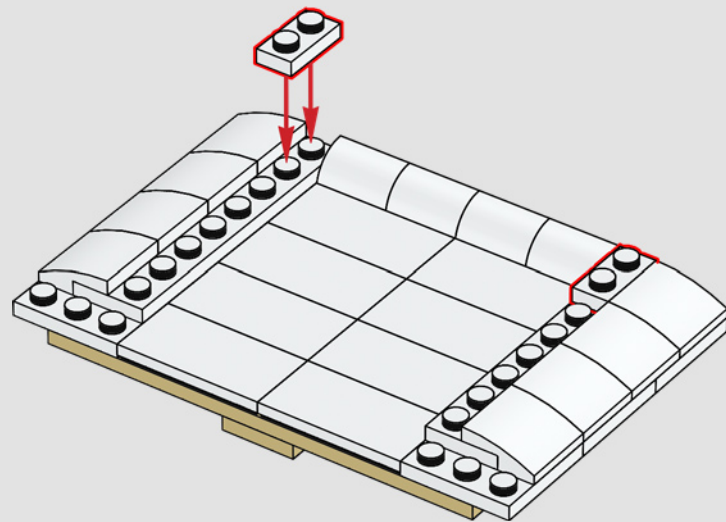

262

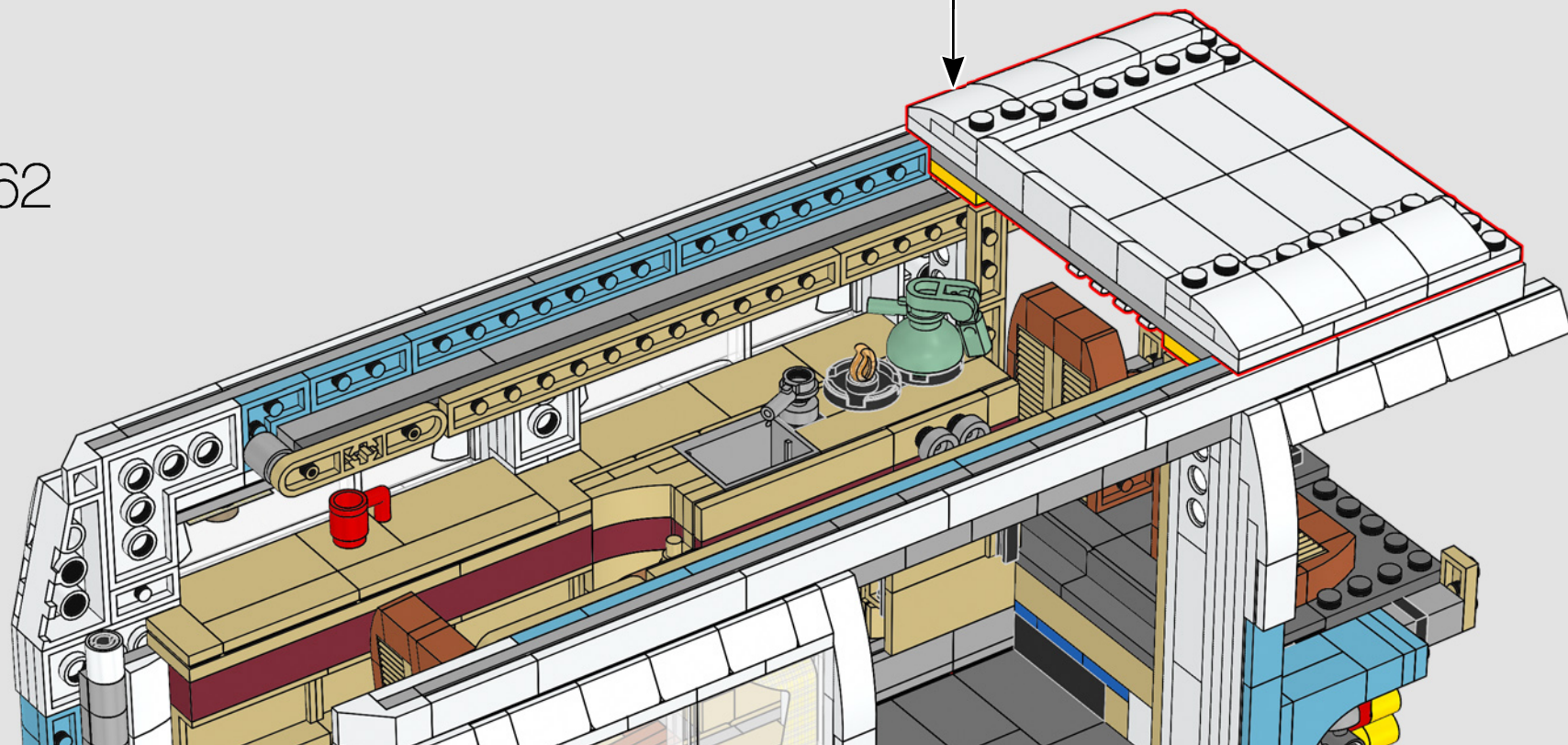

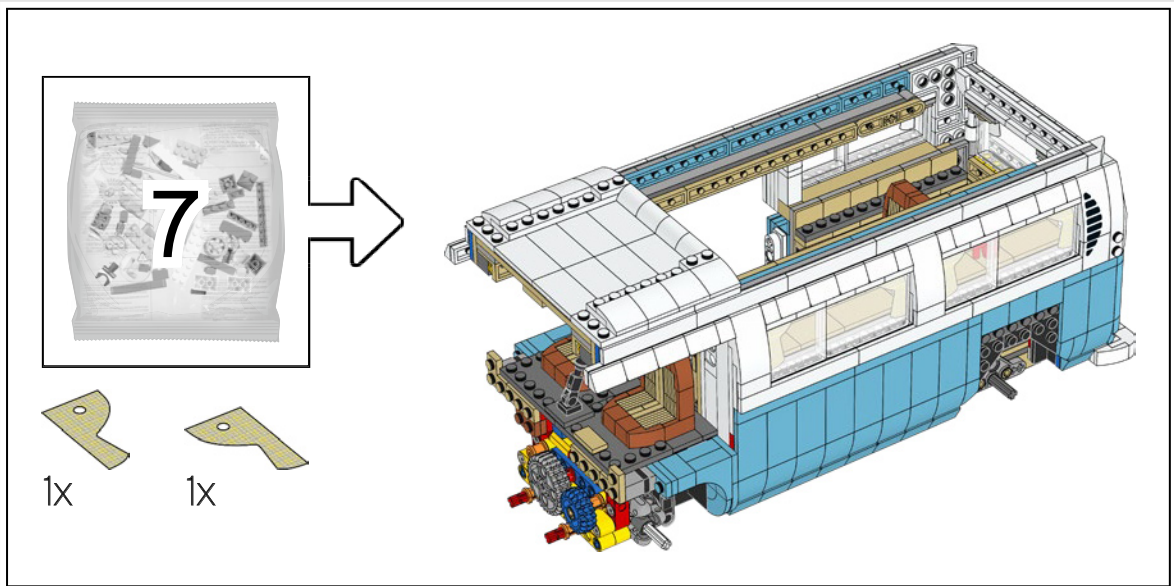

263

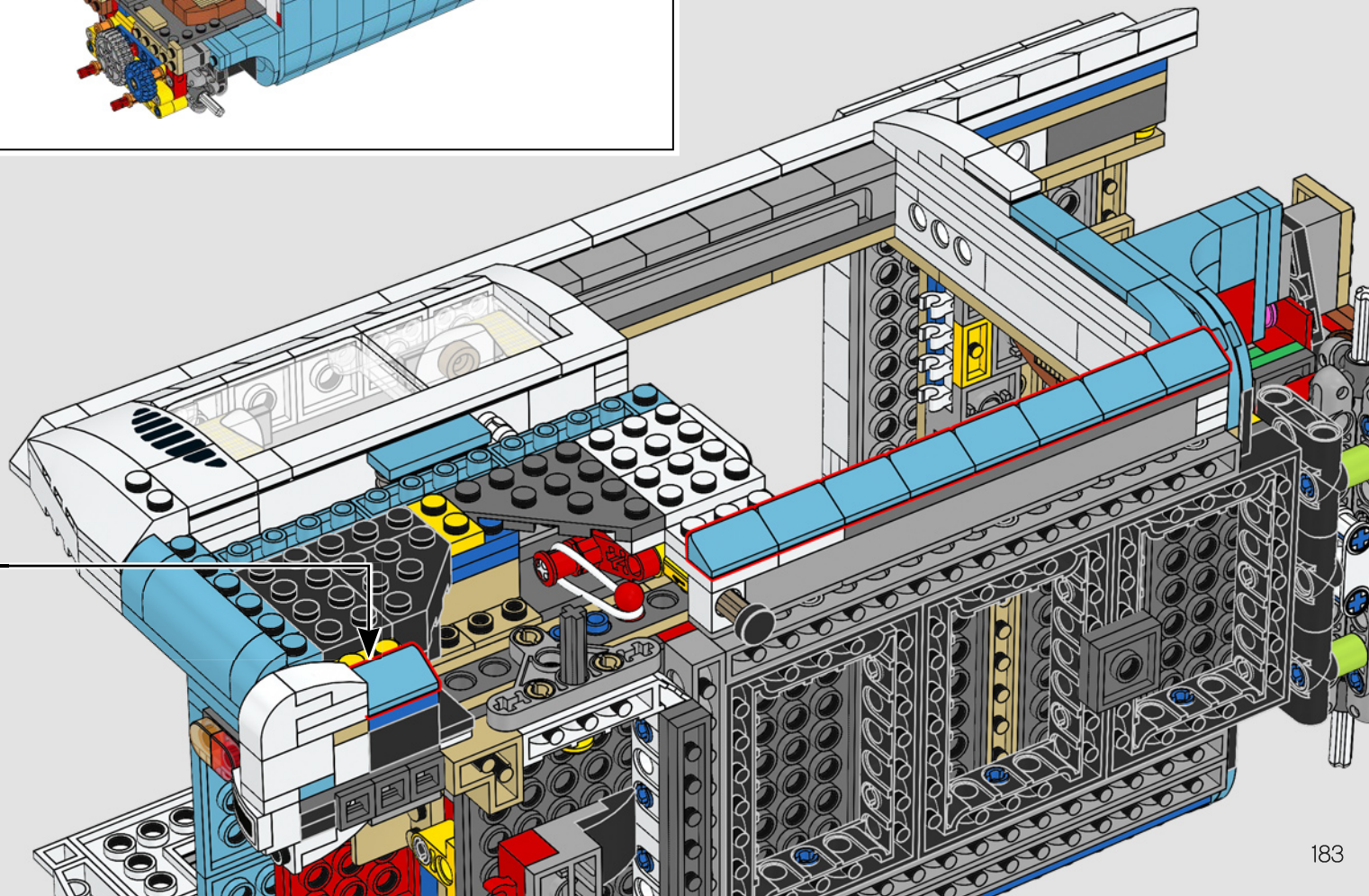
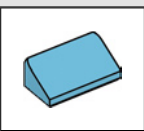
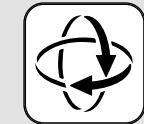

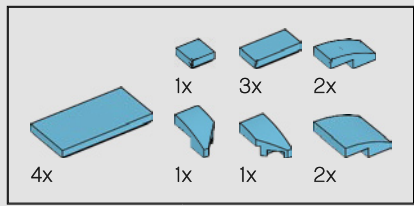

264

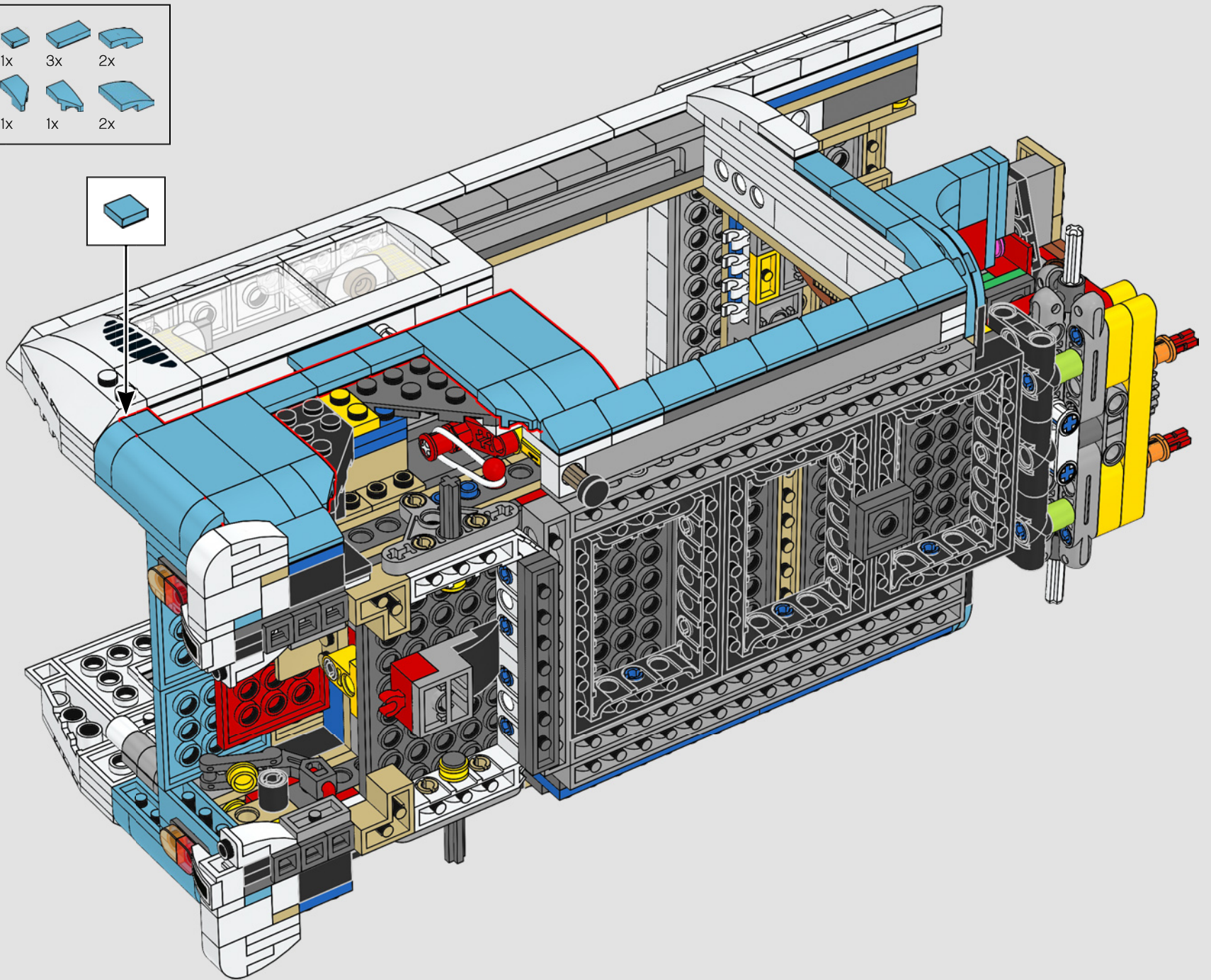
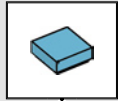

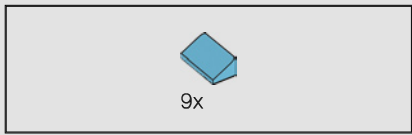

265

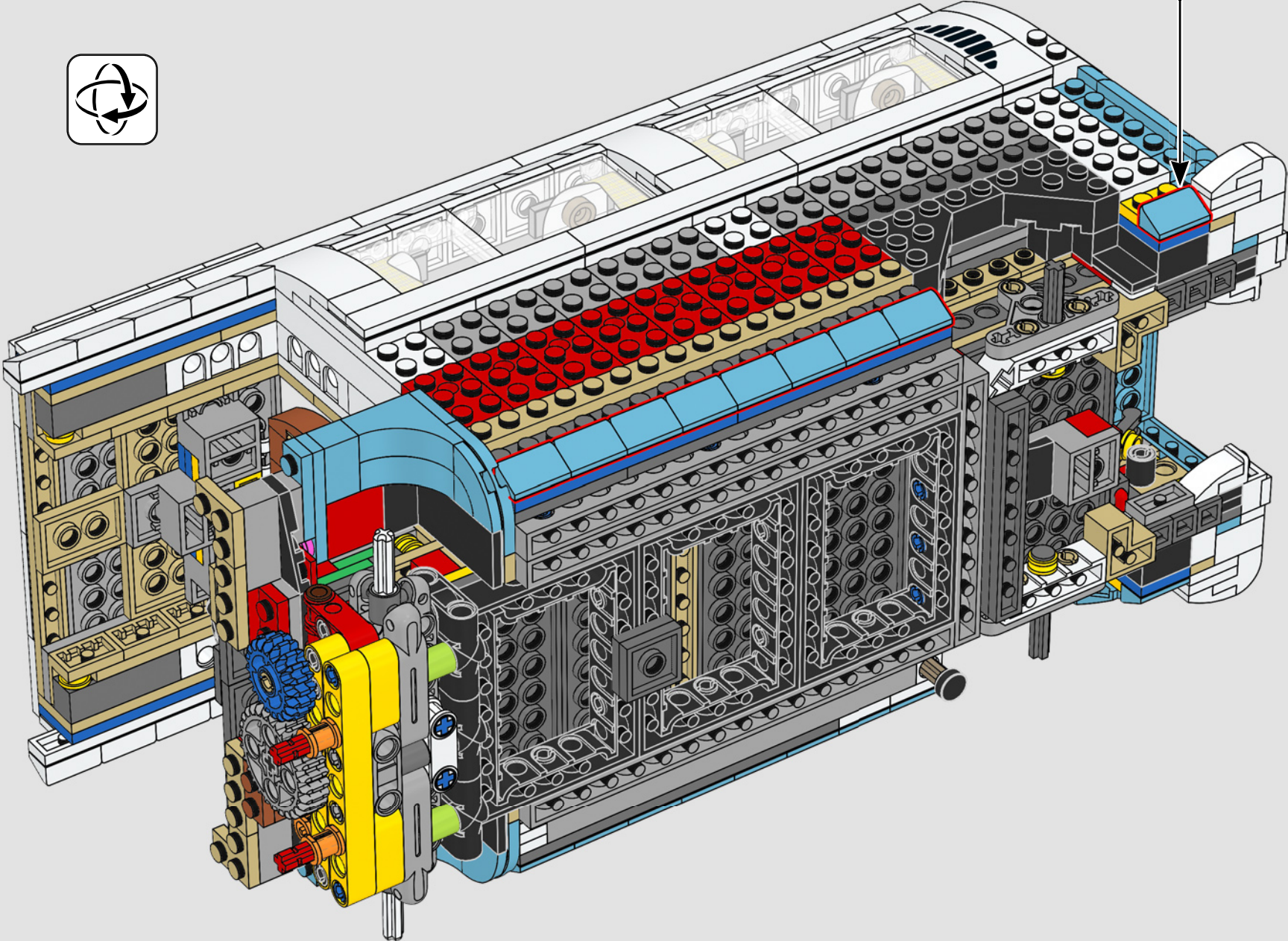
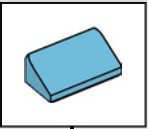

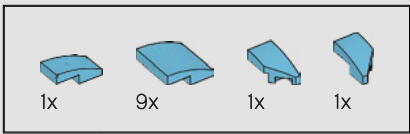

266

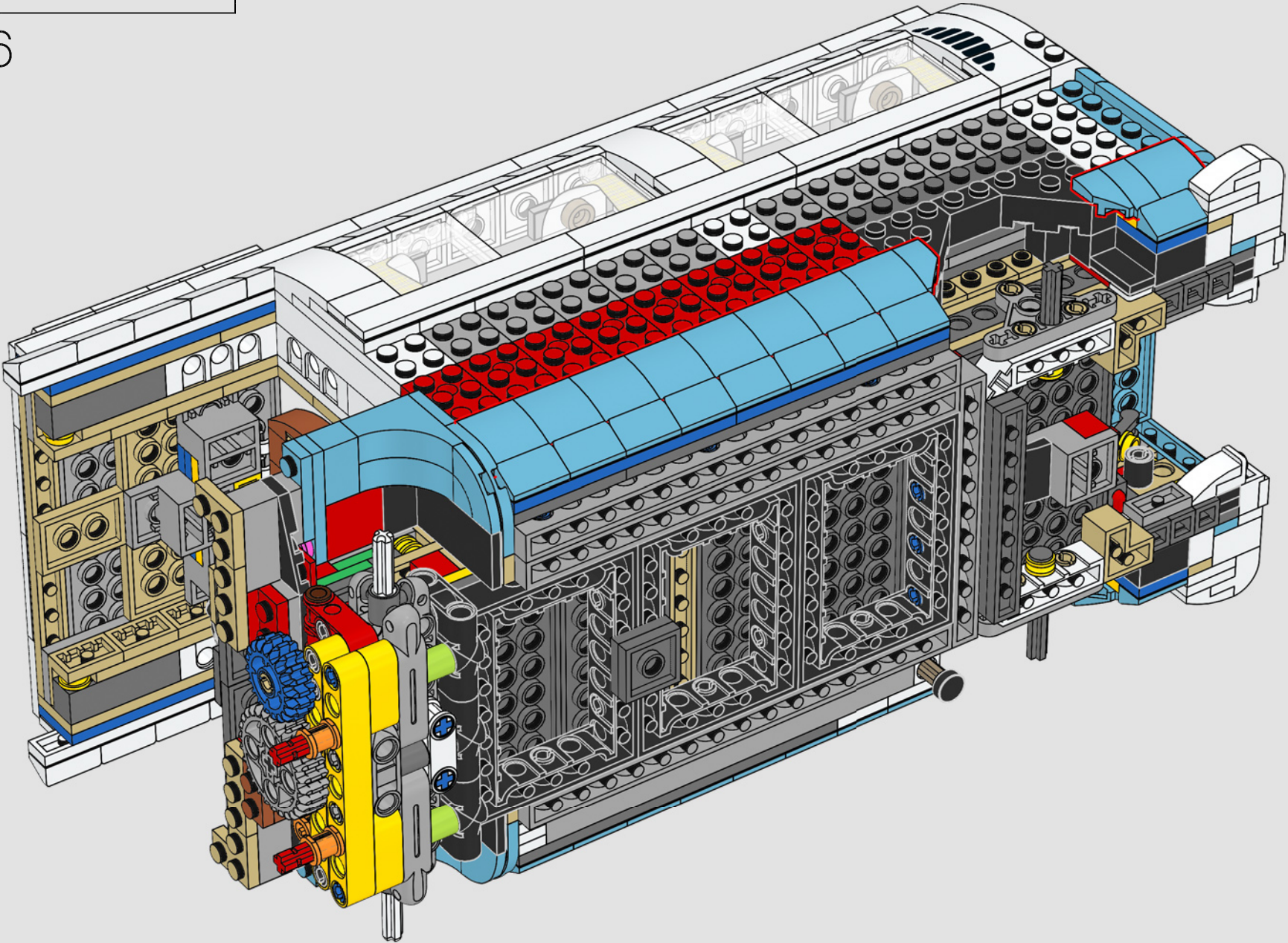

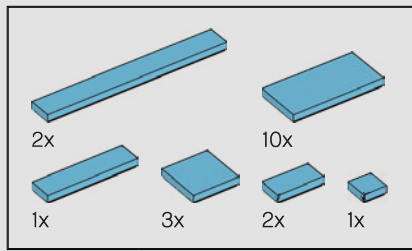

267

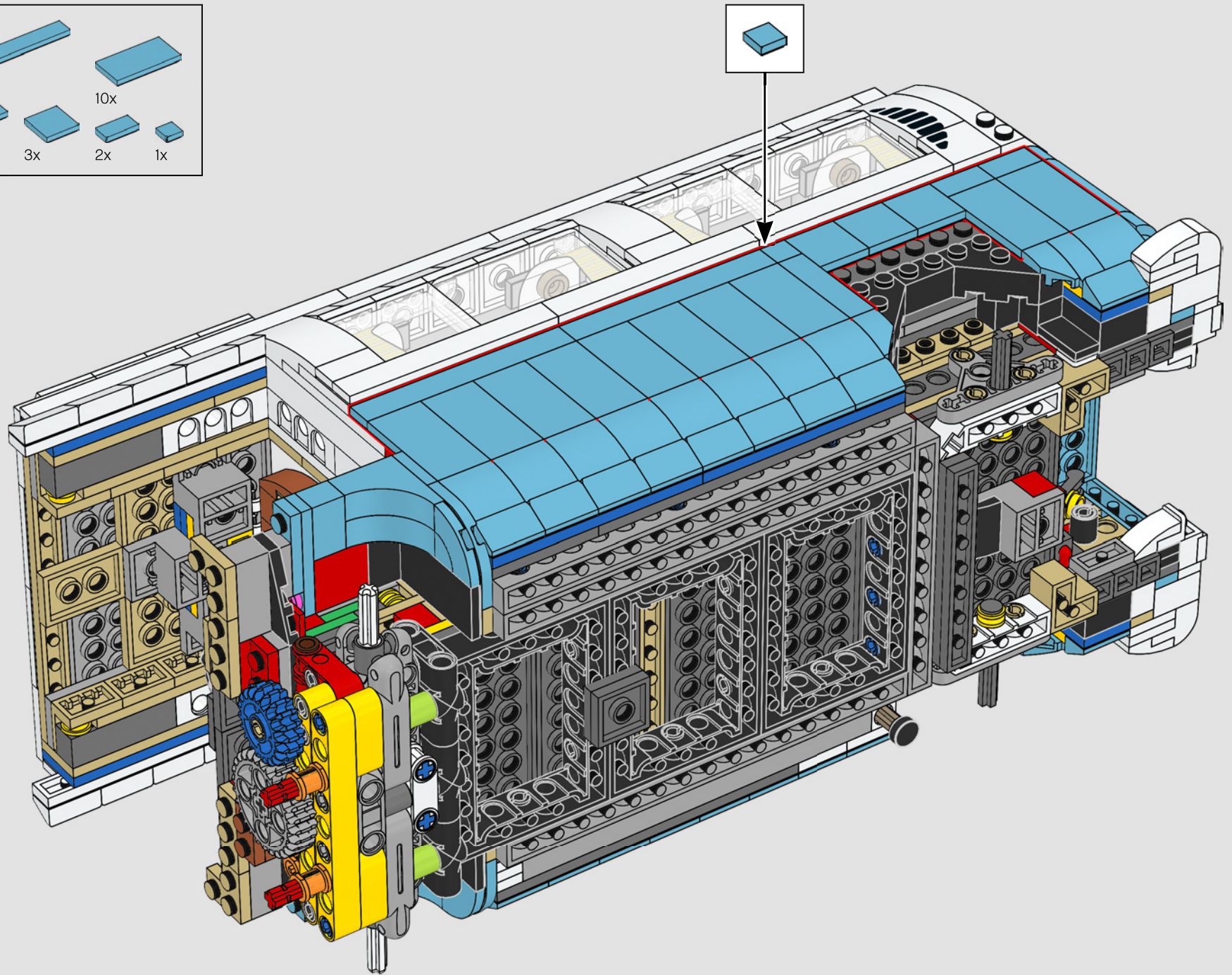

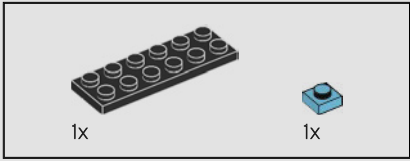
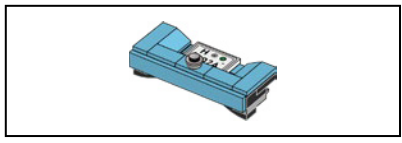

268

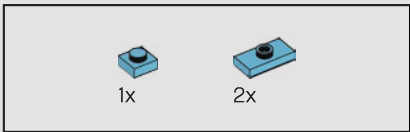
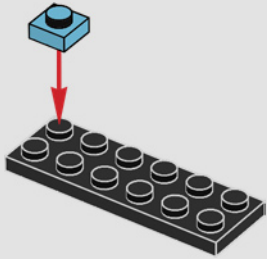

269

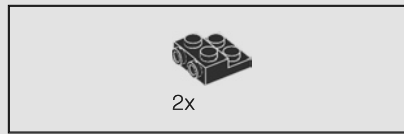
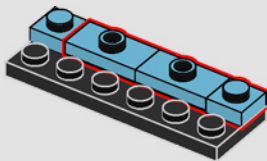

270

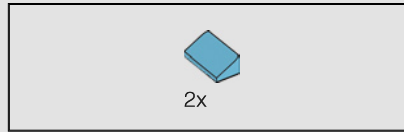
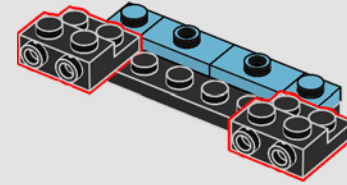

271

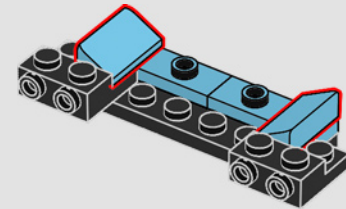

272

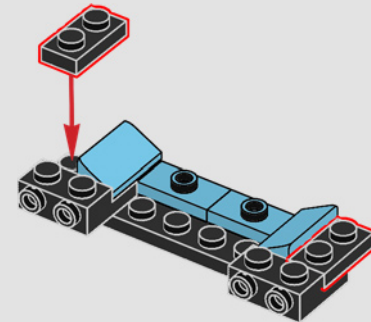

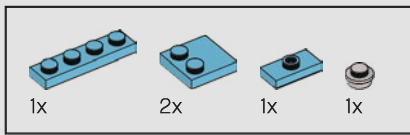

273

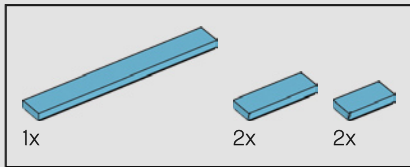
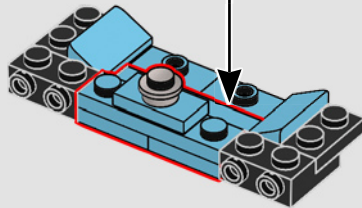
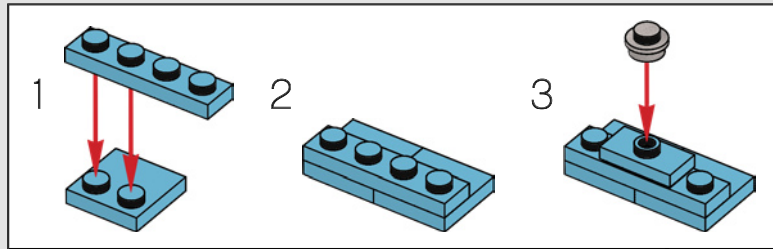

274

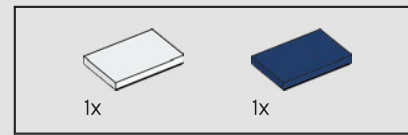
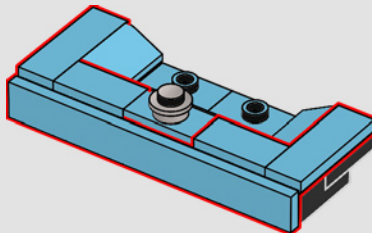

275

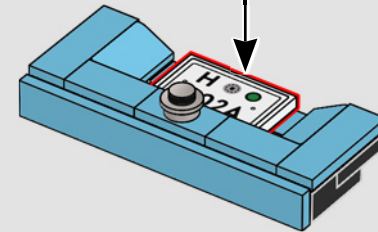
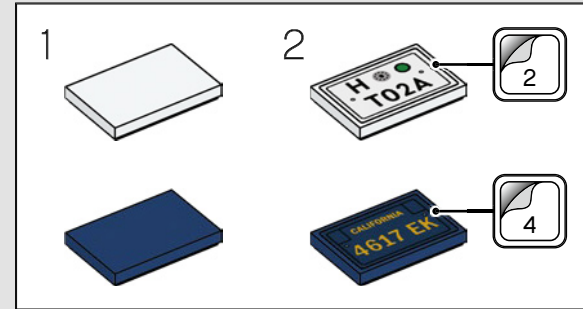

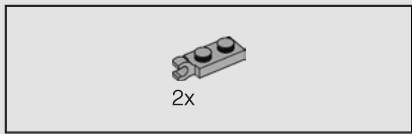

276

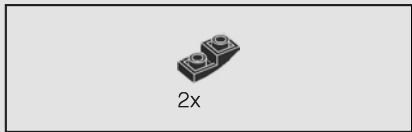
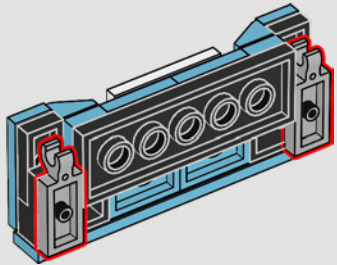

277

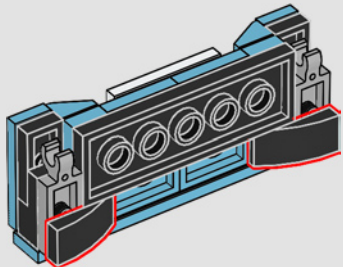

278

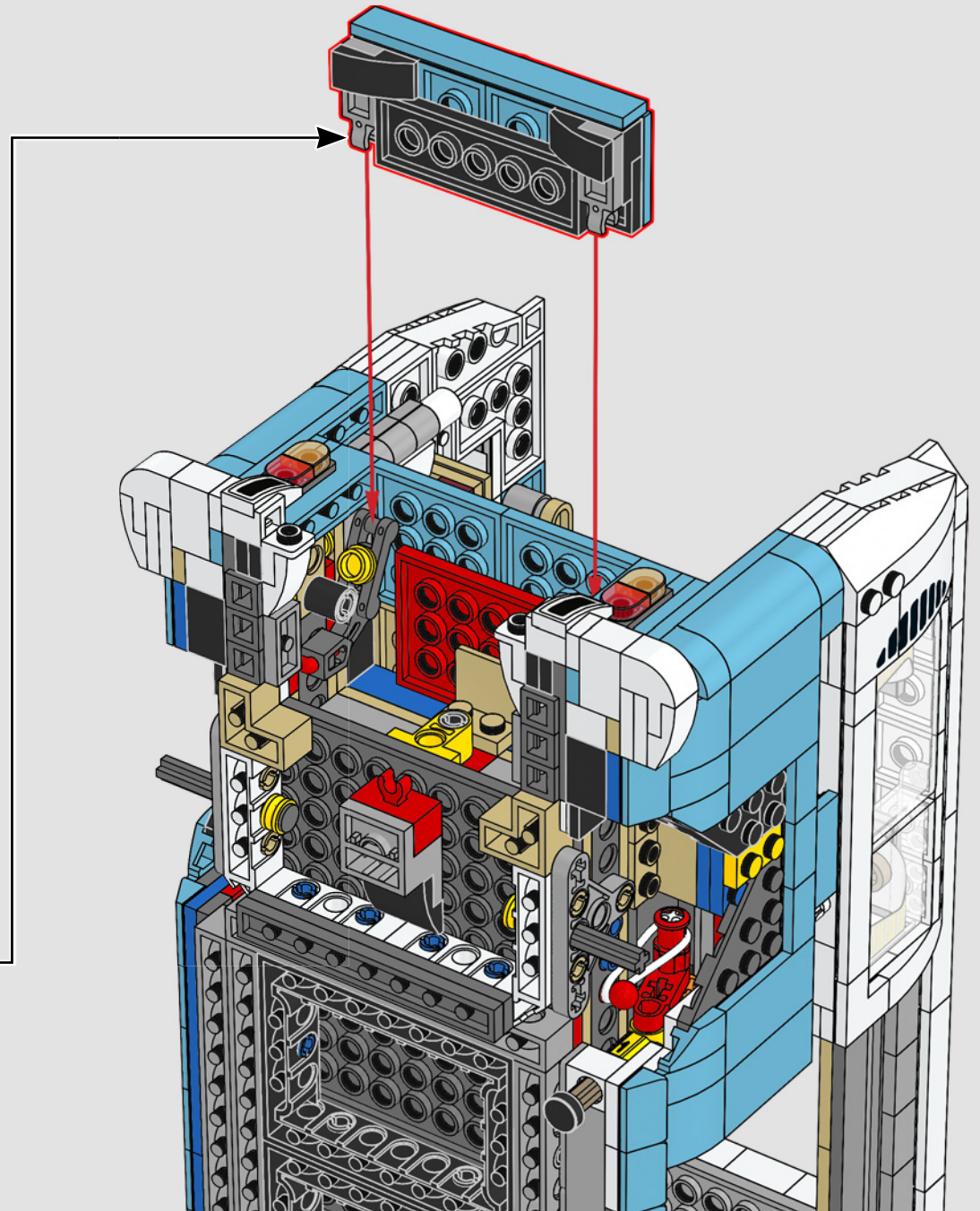

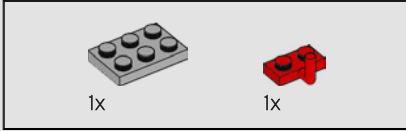
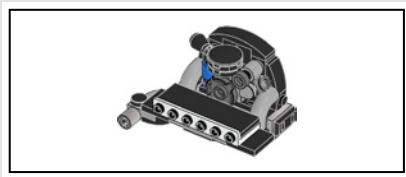

279

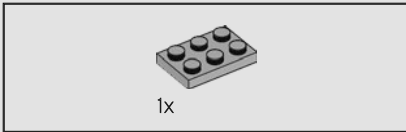
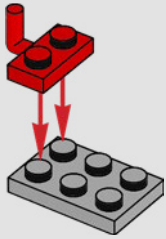

280

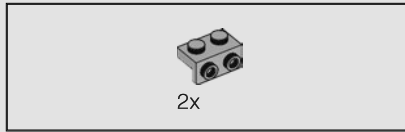
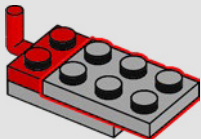

281

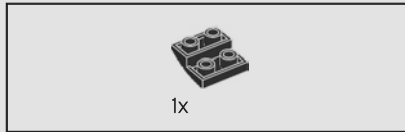
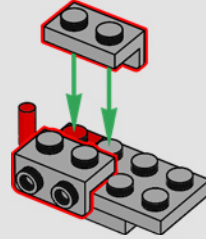

282

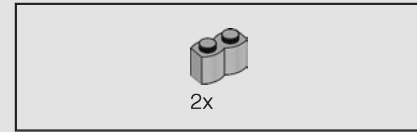
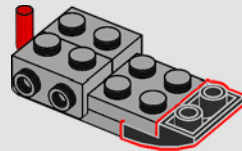

283

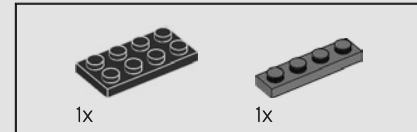
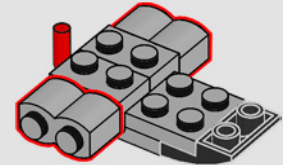

284

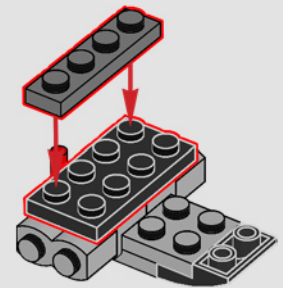

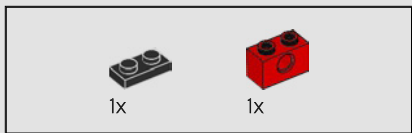

285

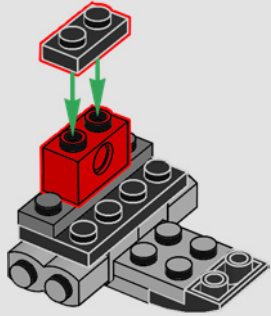

286

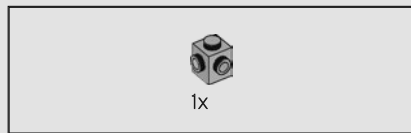
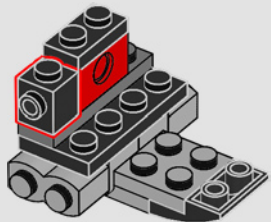

287

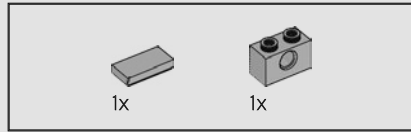
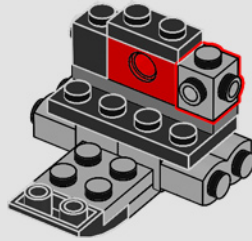
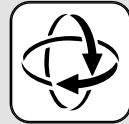

288

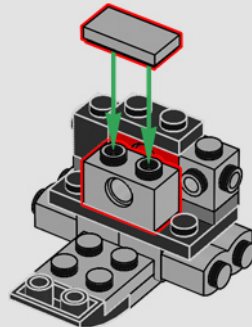

289

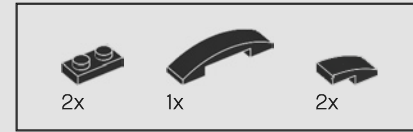
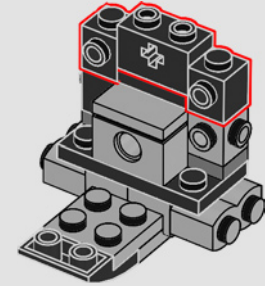

290

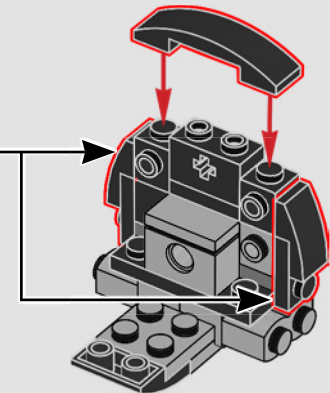
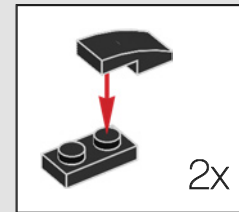



291

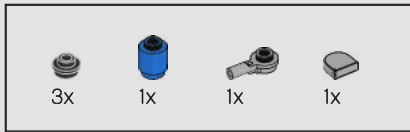
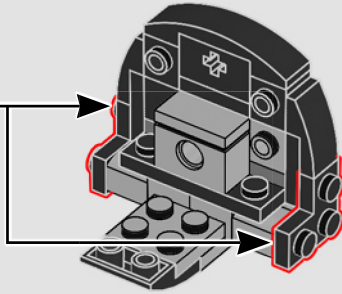
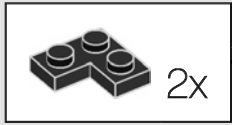

292

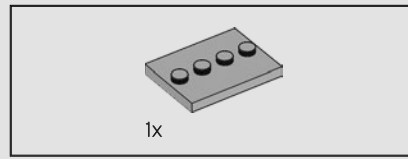
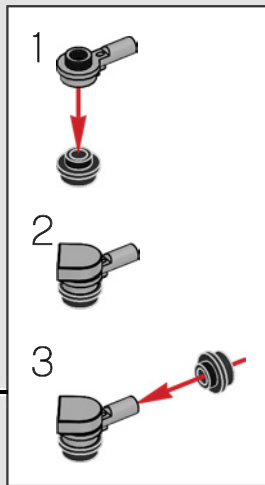
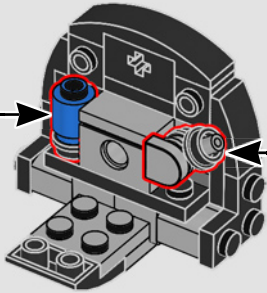
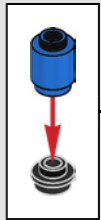

293

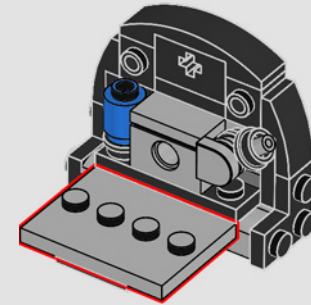

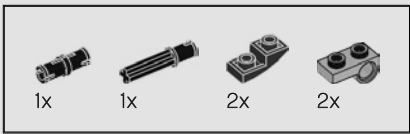

294

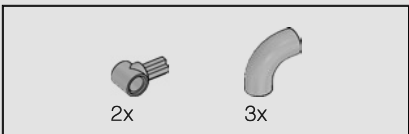
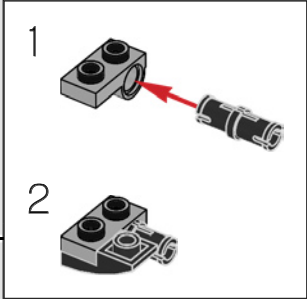
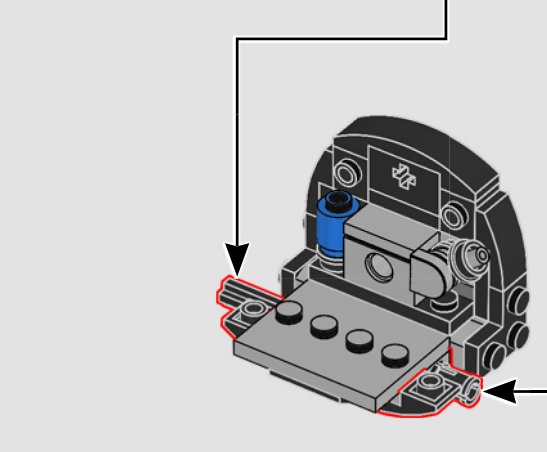
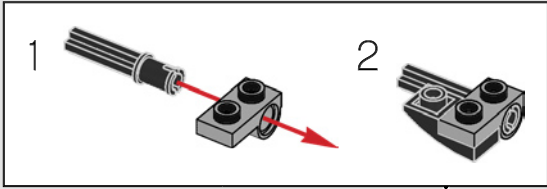

295

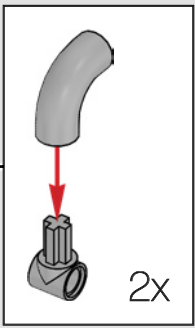
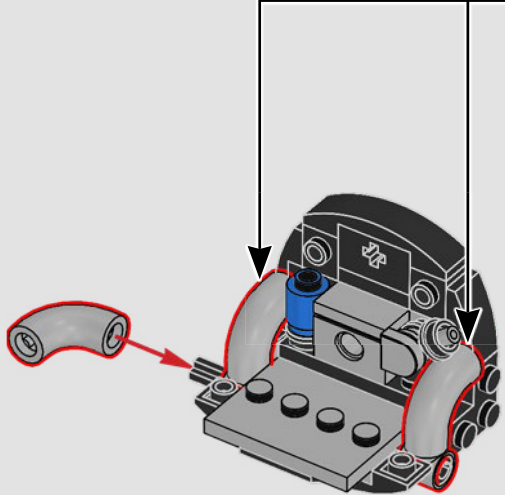

296

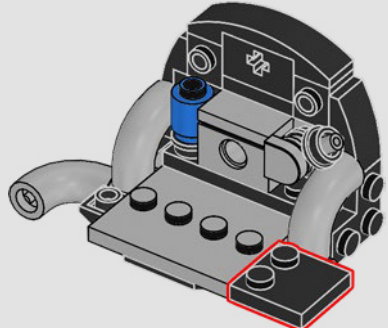

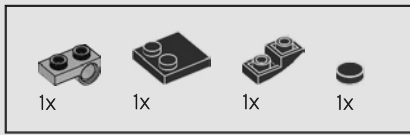

297

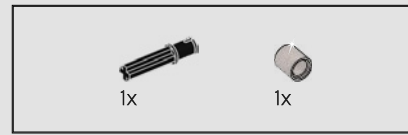
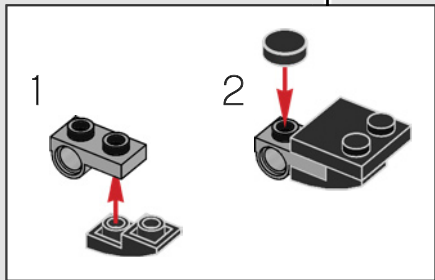
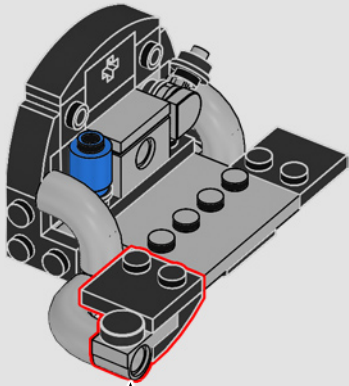

298

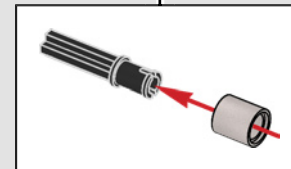
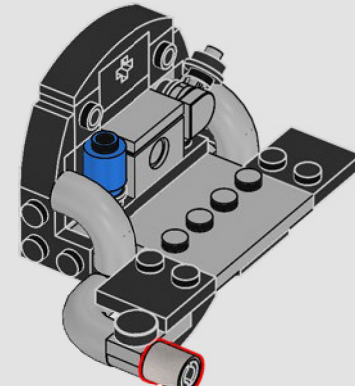

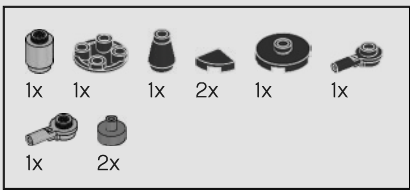

299

1



2



3

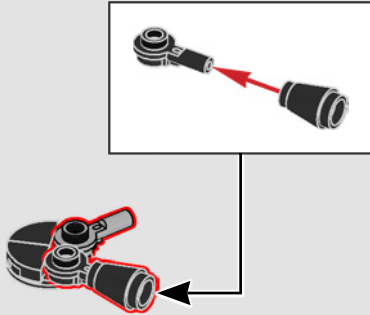

4

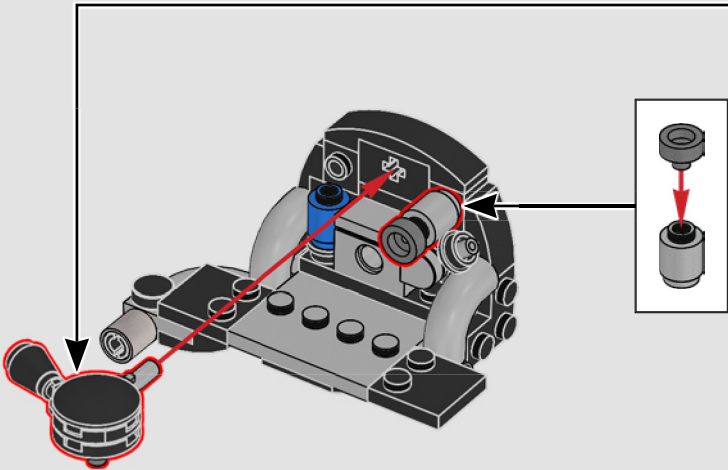



300

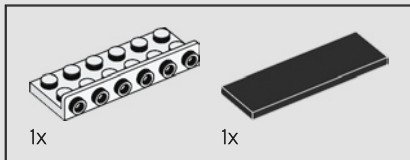
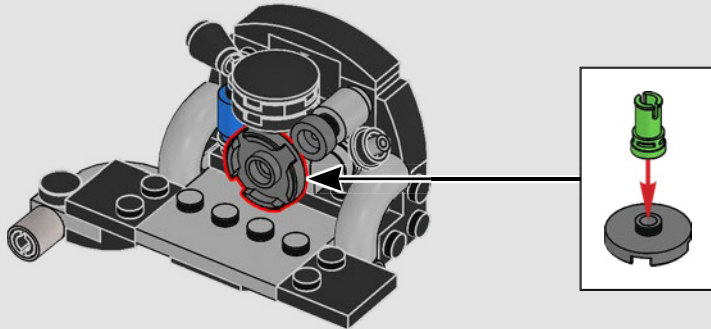

301

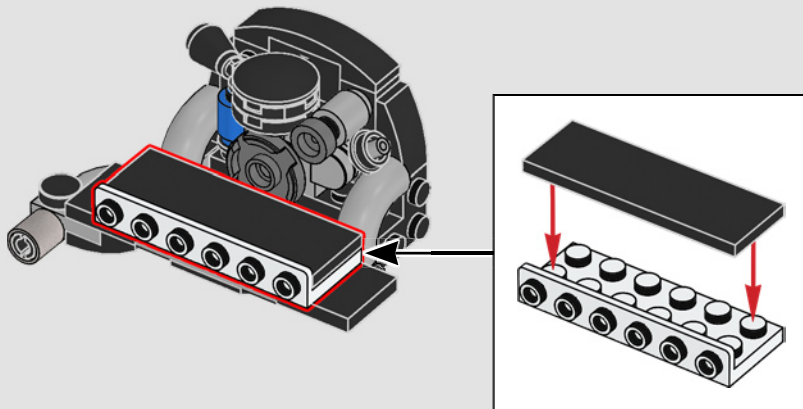

302

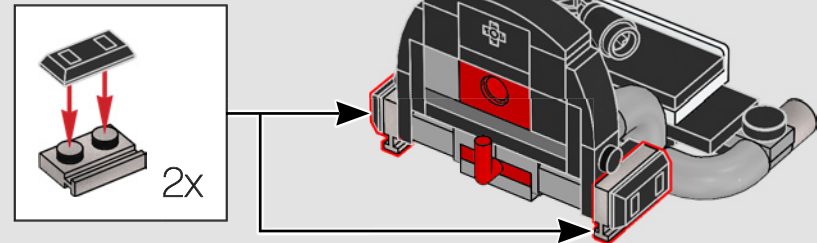
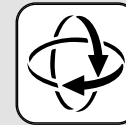

Il motore boxer raffreddato ad aria era famoso per la sua affidabilità, potenza modesta ma efficiente e il suo riconoscibilissimo rombo.

303

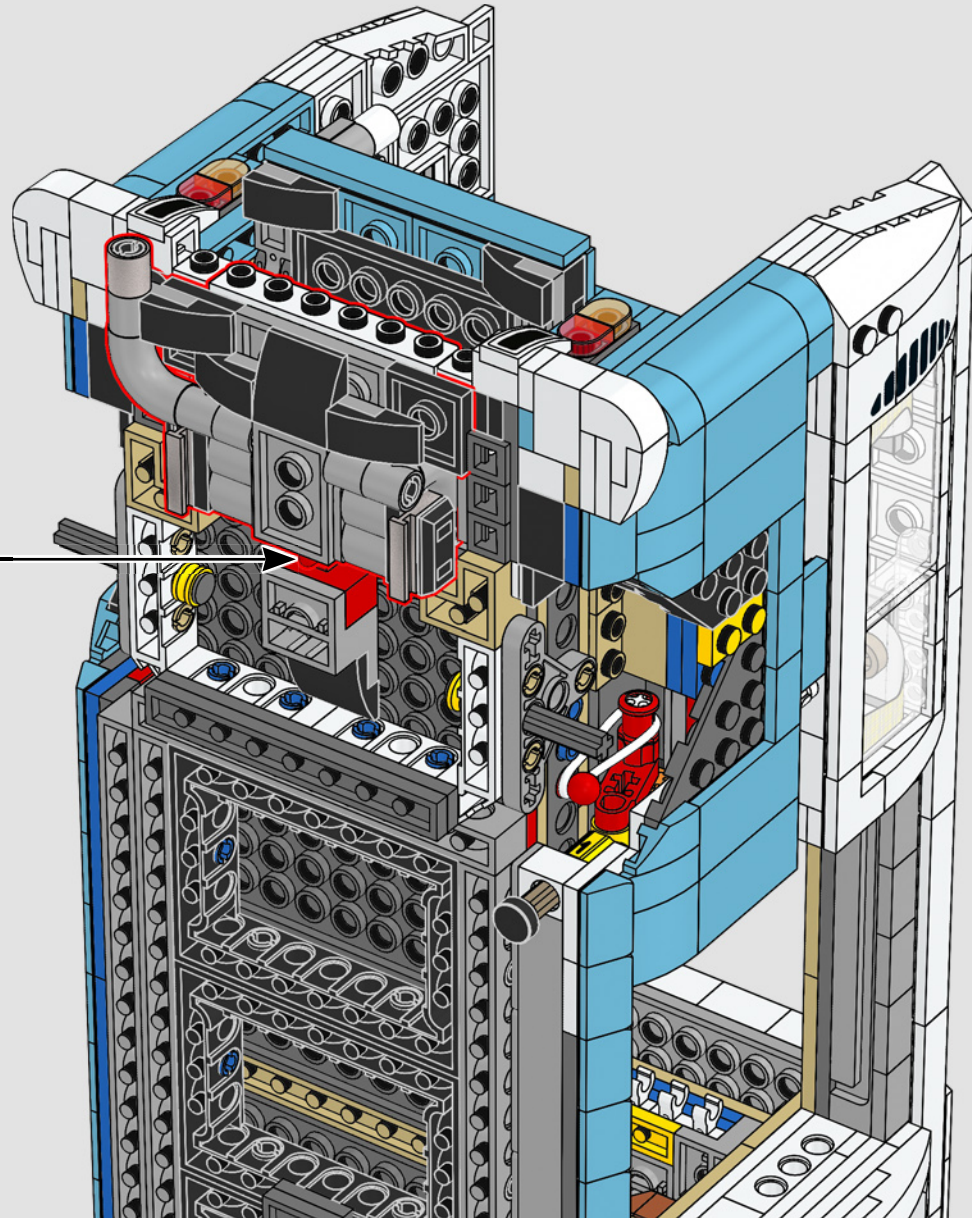

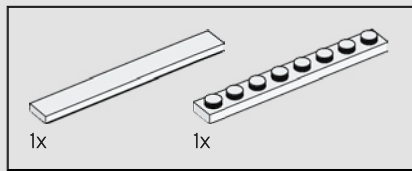

304

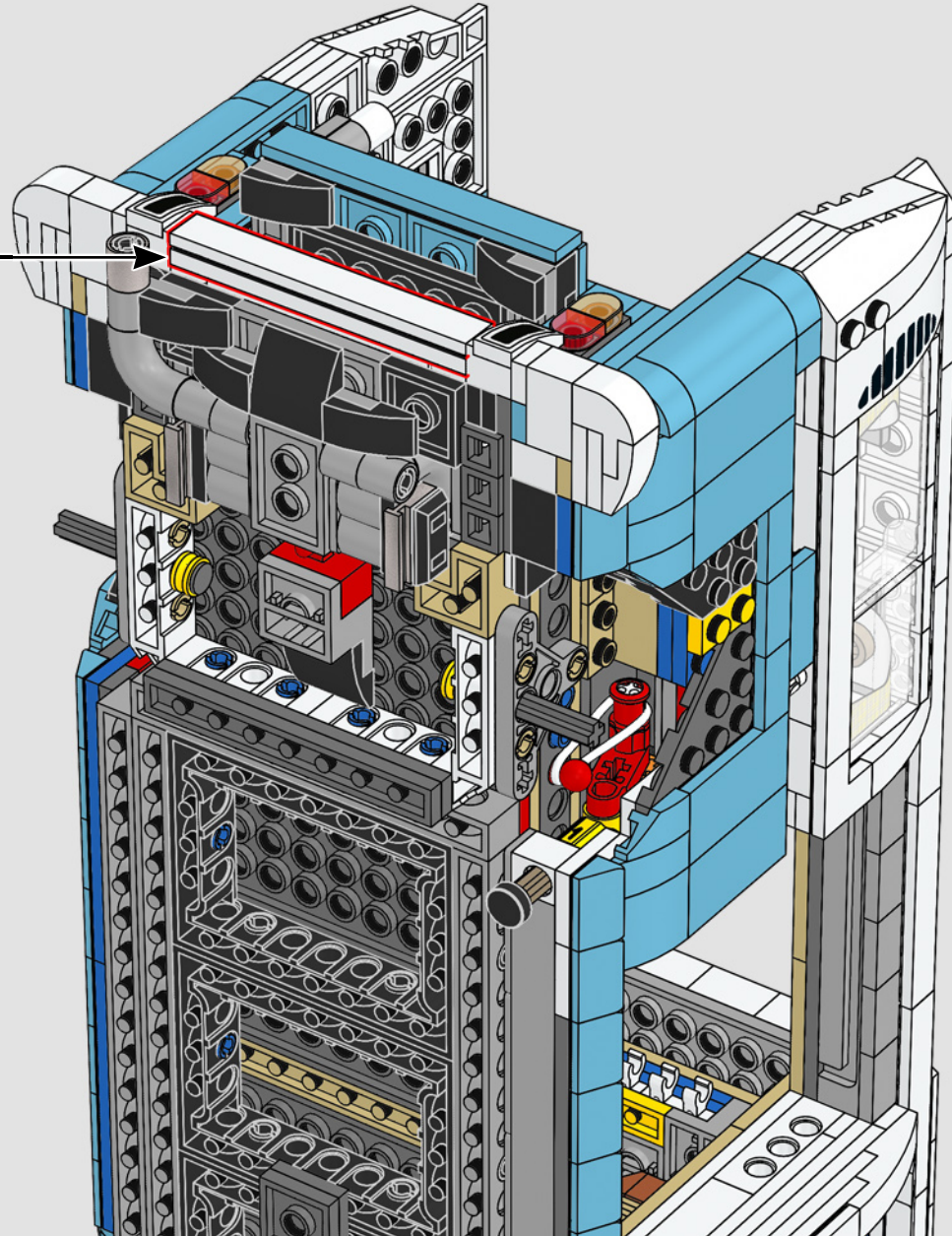
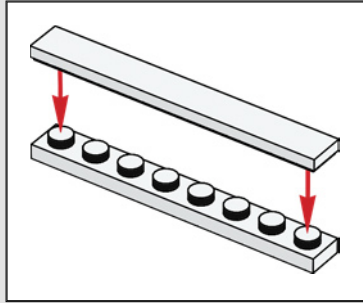

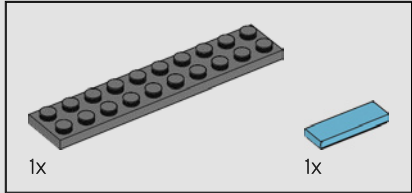
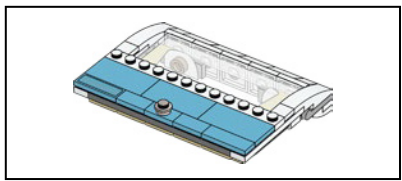

305

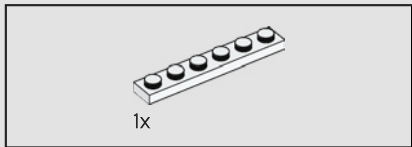
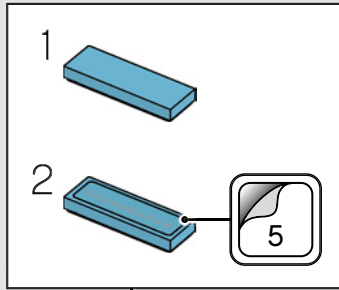
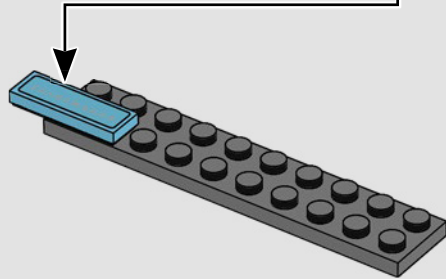

306

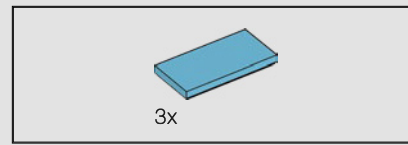
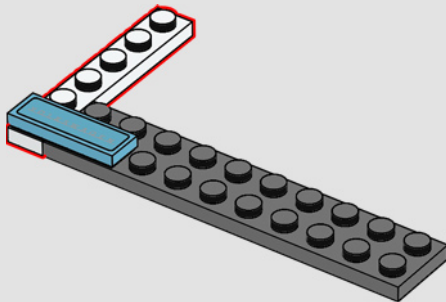

307

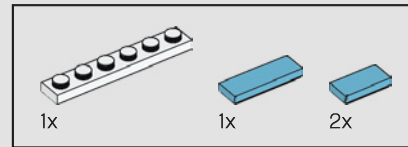
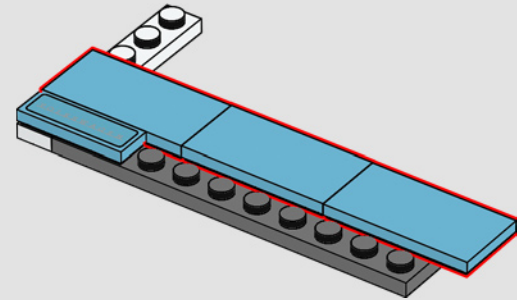

308

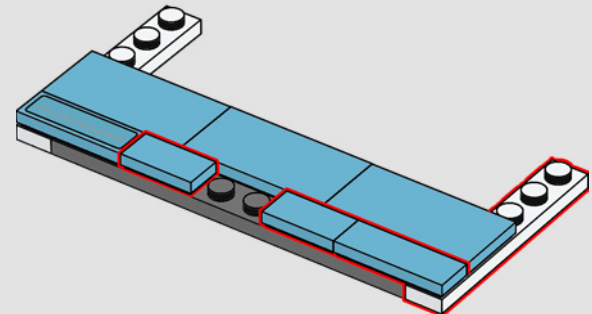

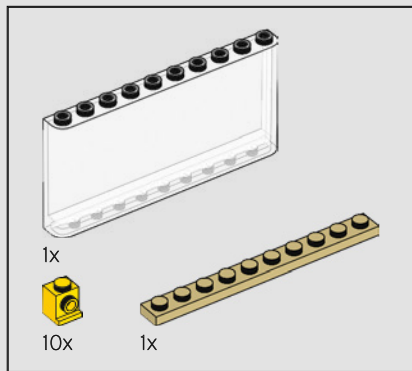

309

1

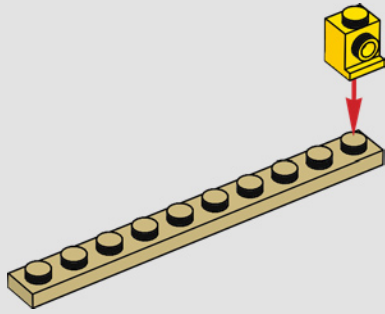

2

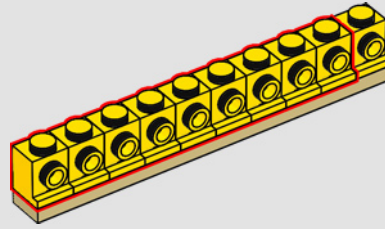

3

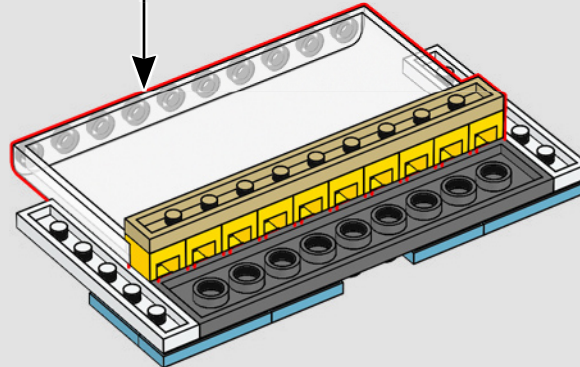
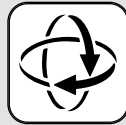
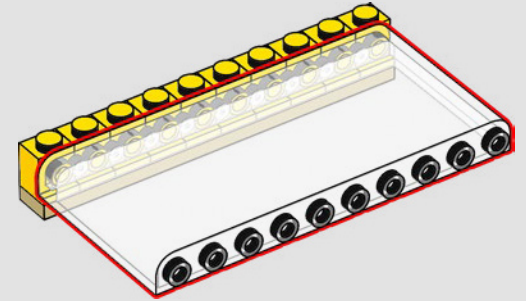

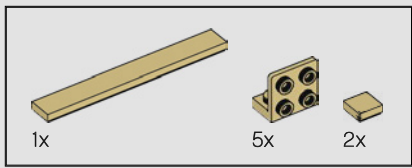

310

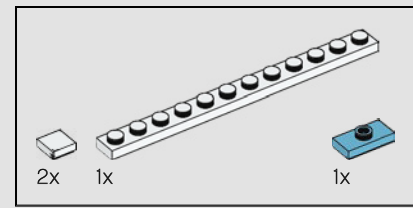
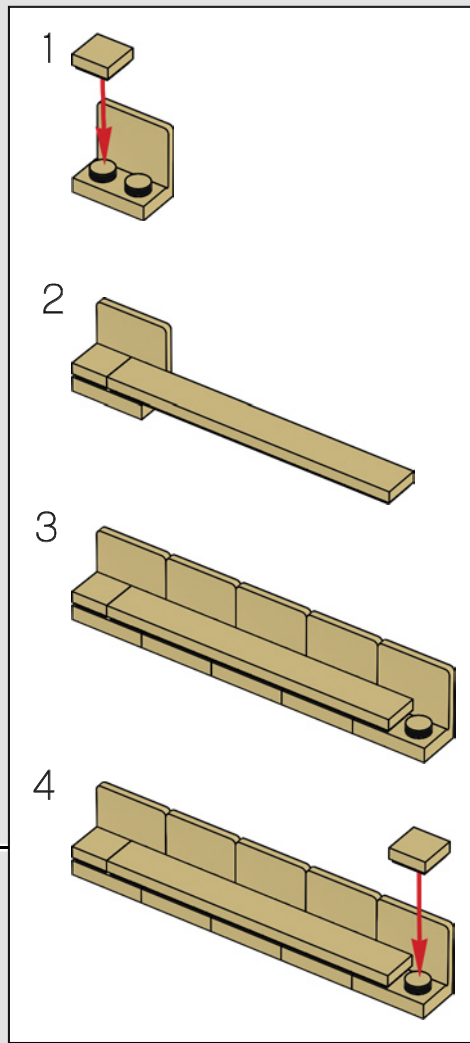
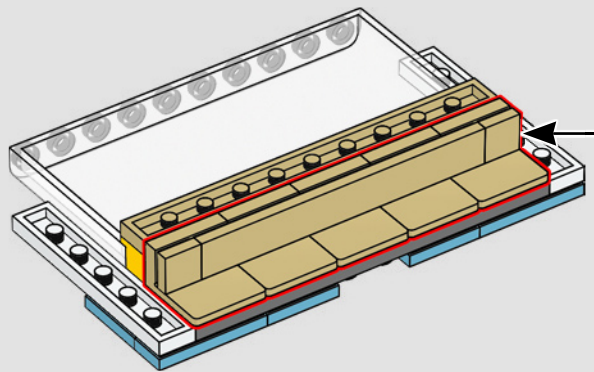

311

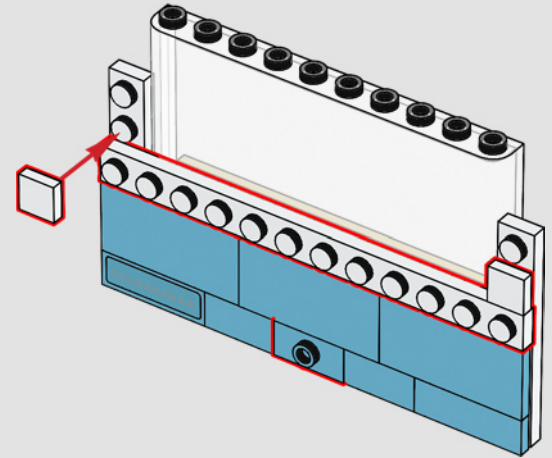

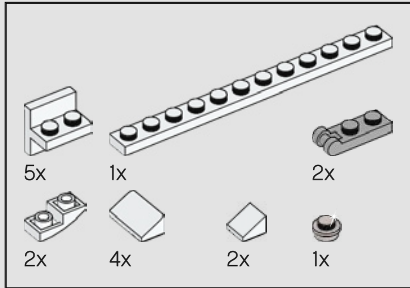
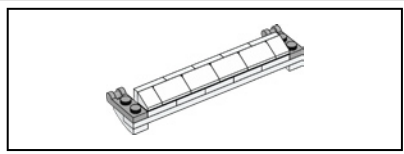

312

1

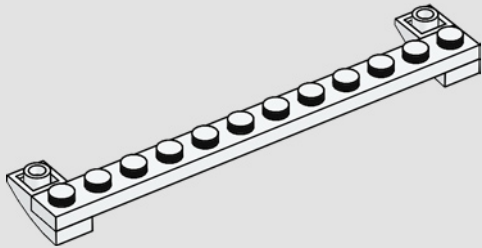

2

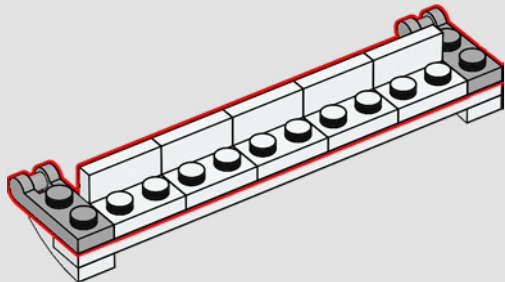

3

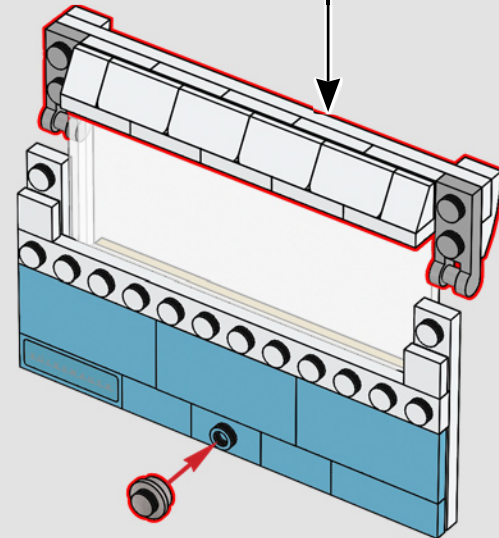
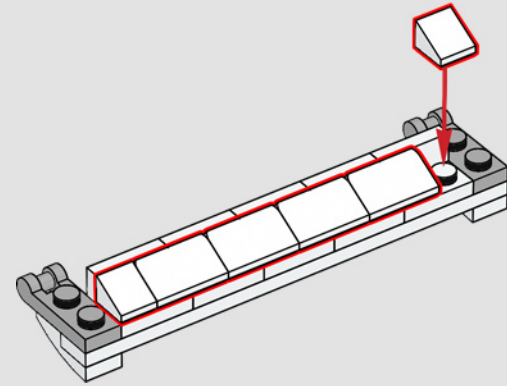

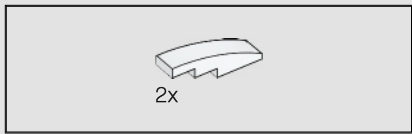

313

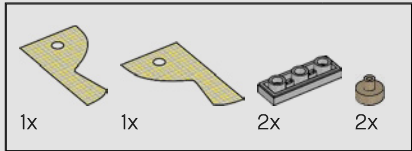
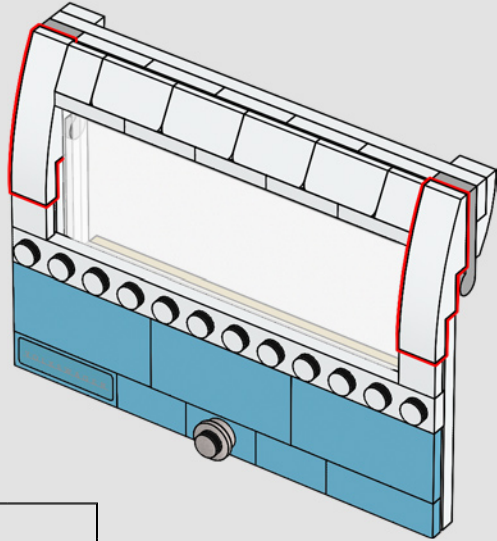

314

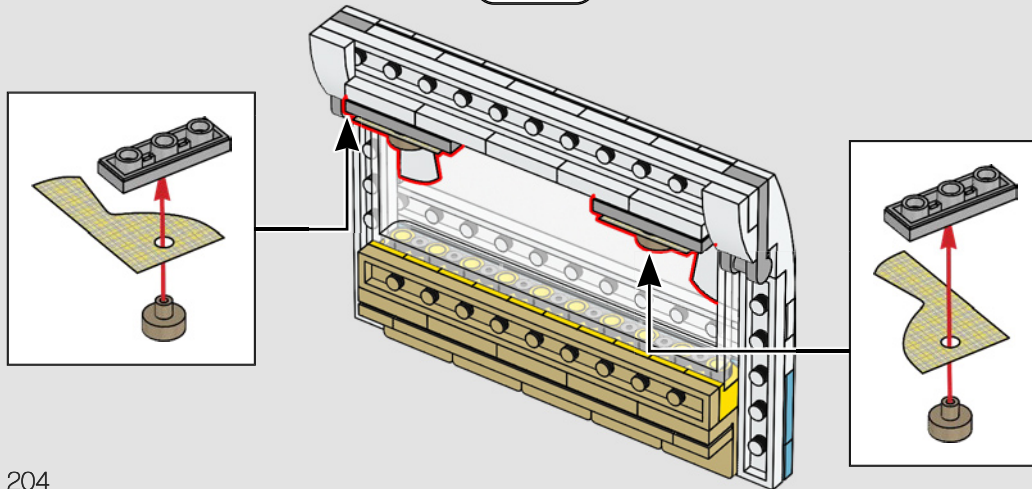

315

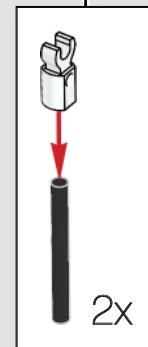
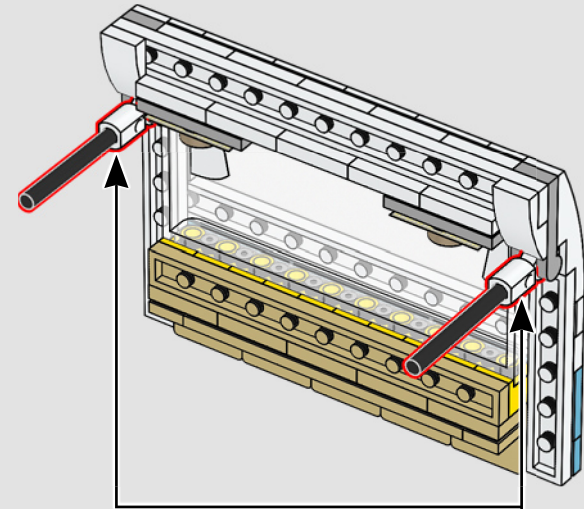

316

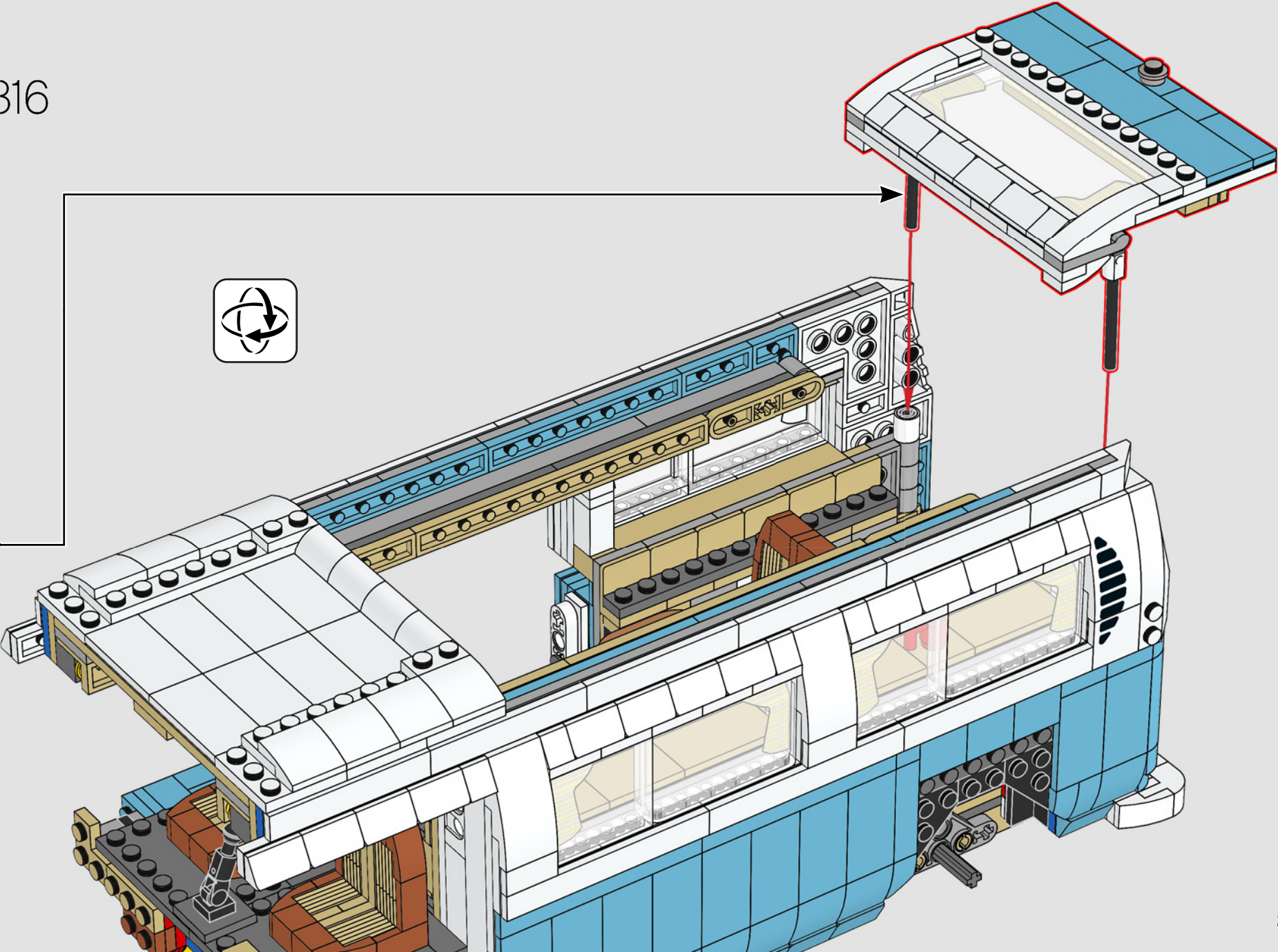

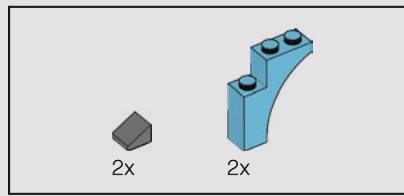
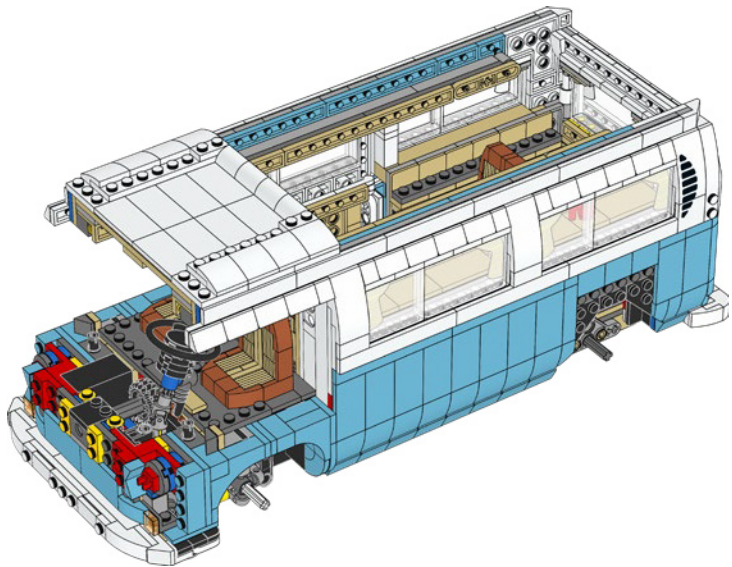
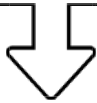

317

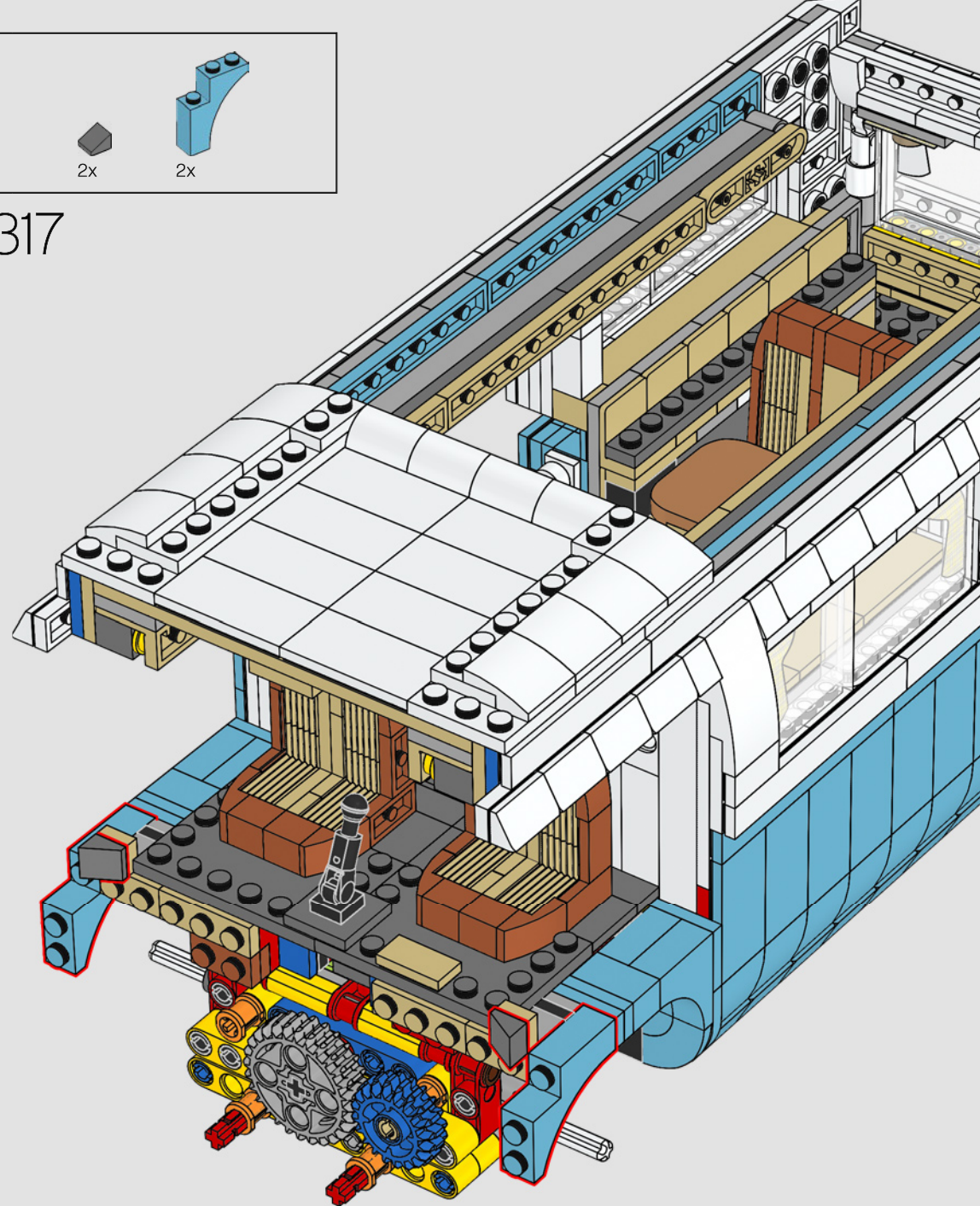

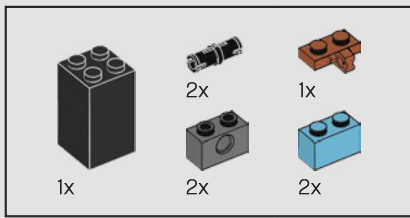

318

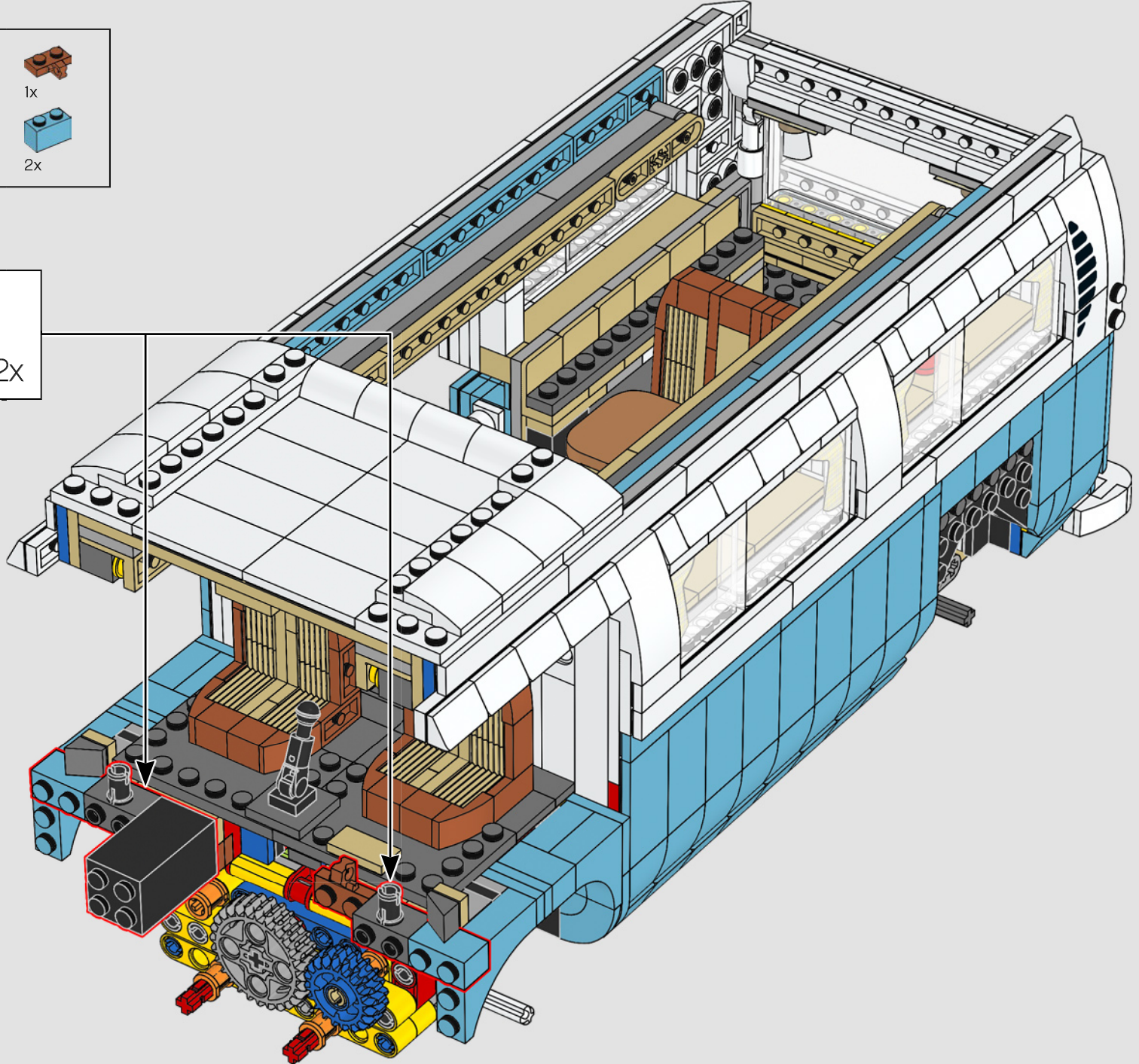
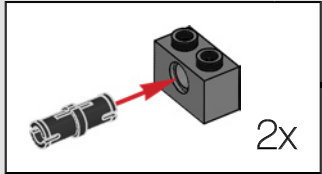

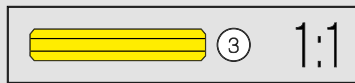
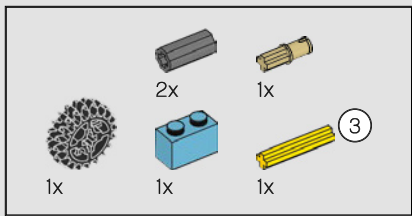

319

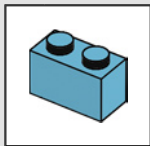
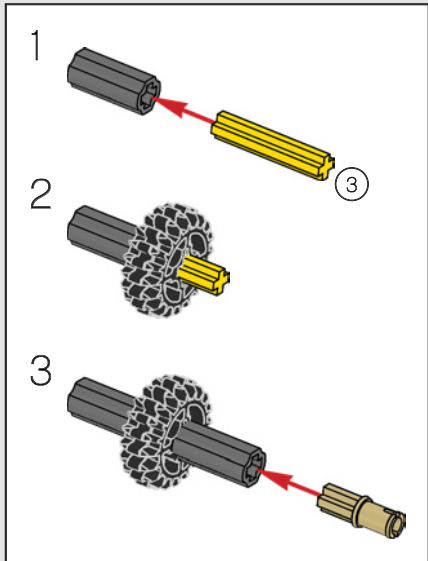
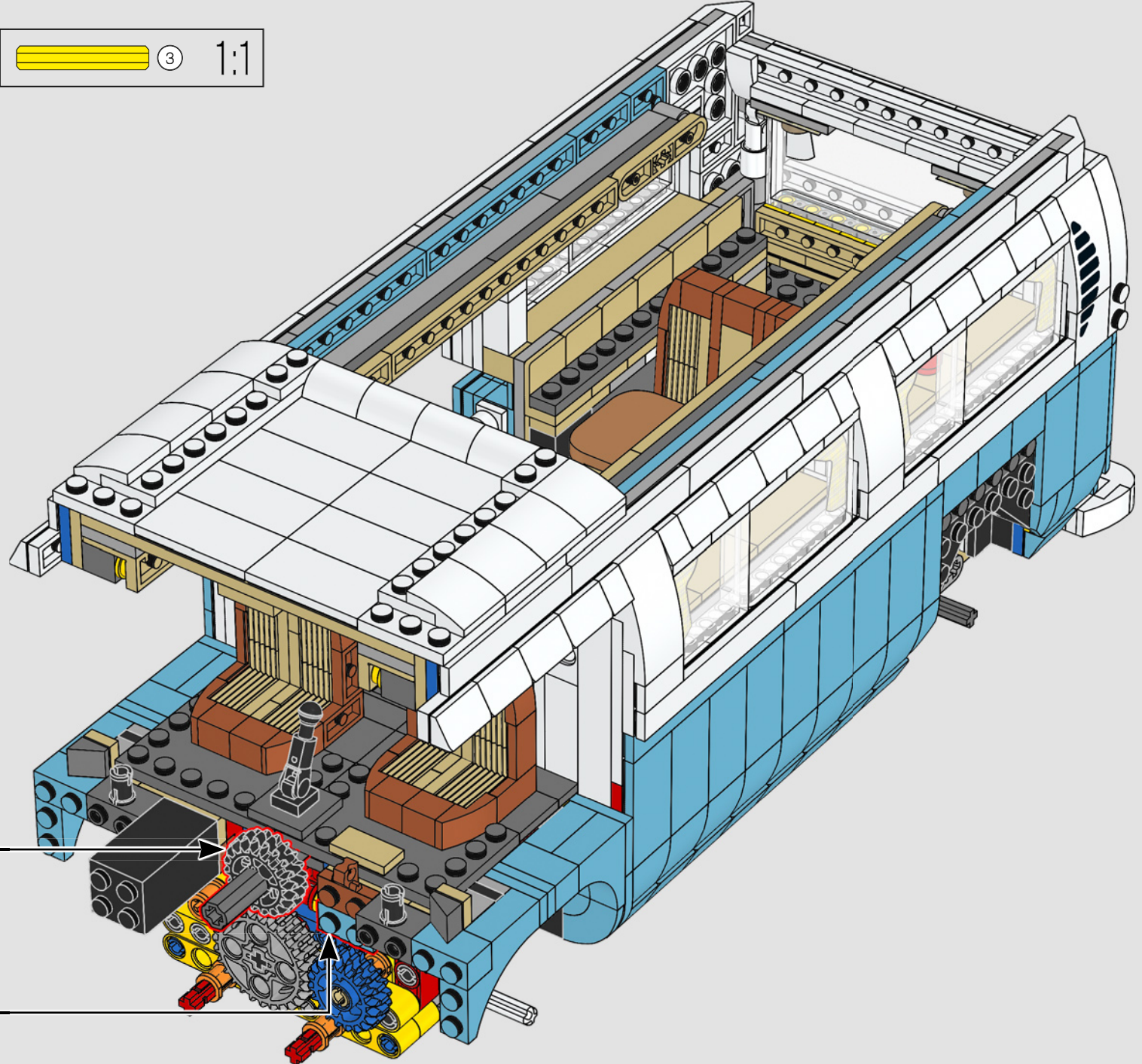

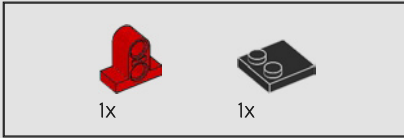

320

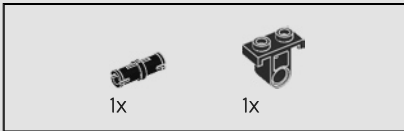
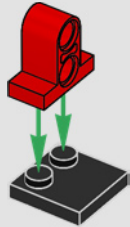

321

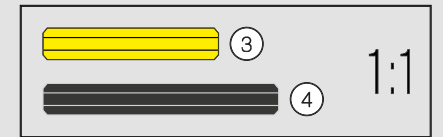
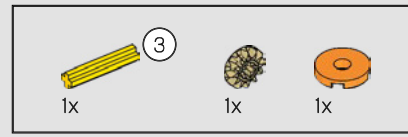
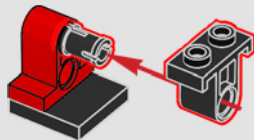

322

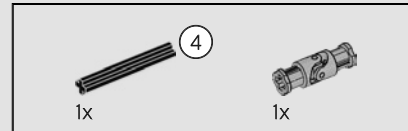
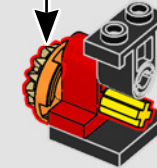
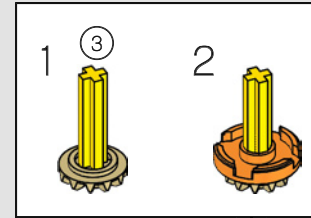

323

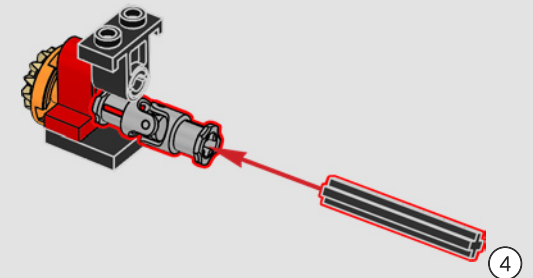

324

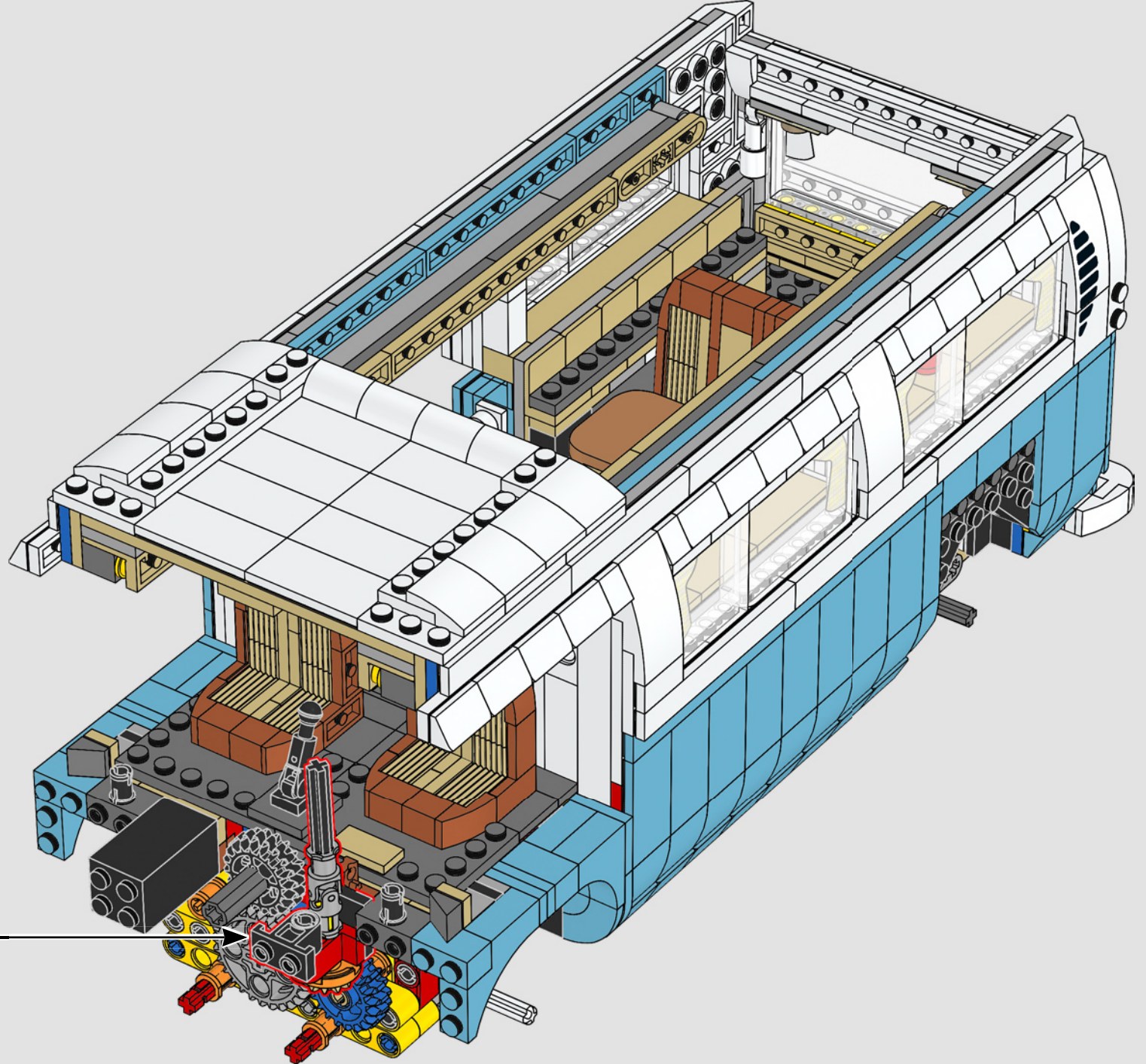

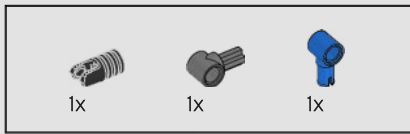

325

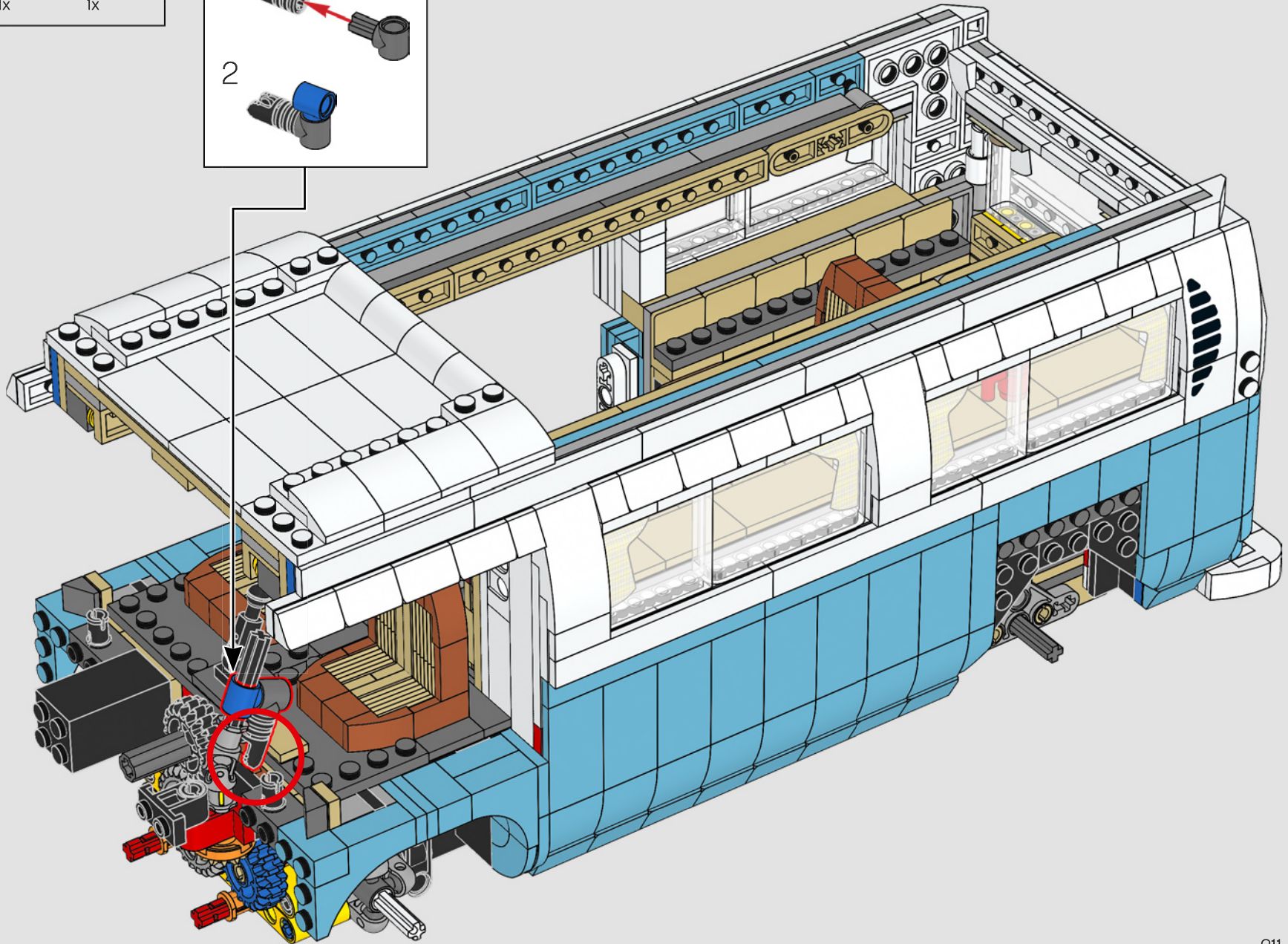
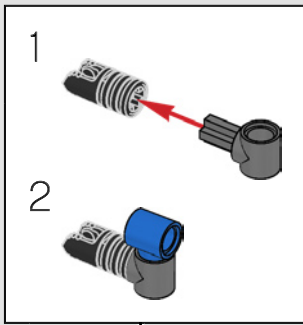

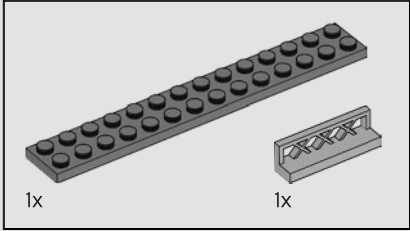
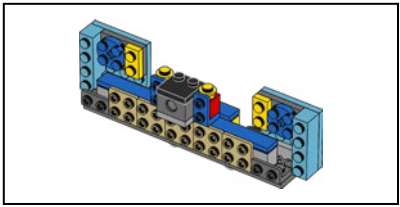

326

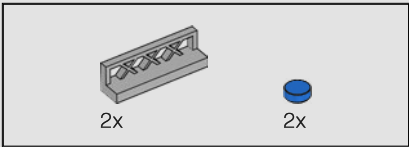
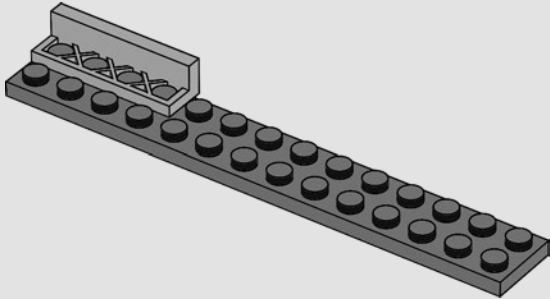

327

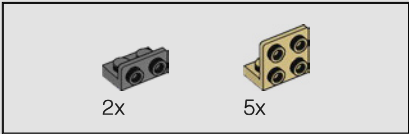
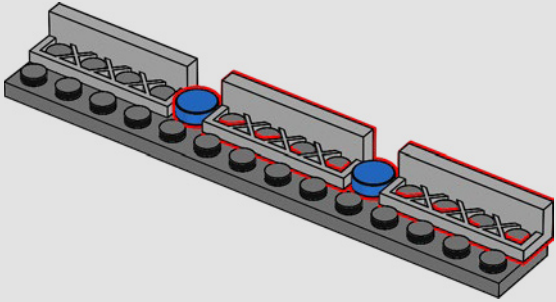

328

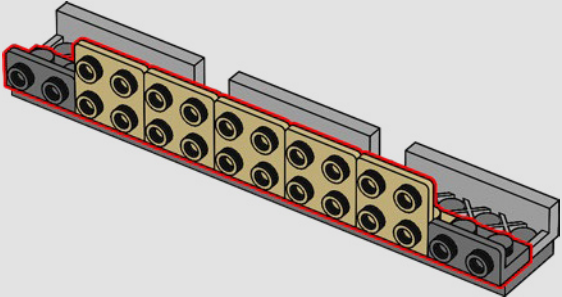

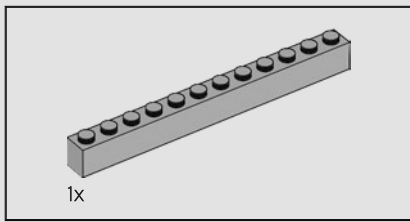

329

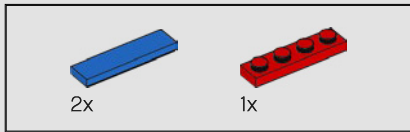
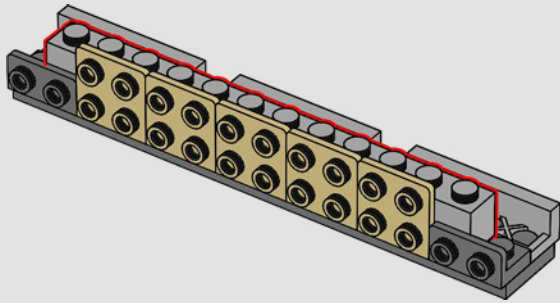

330

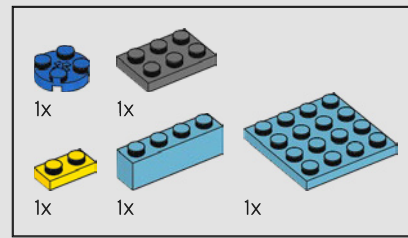
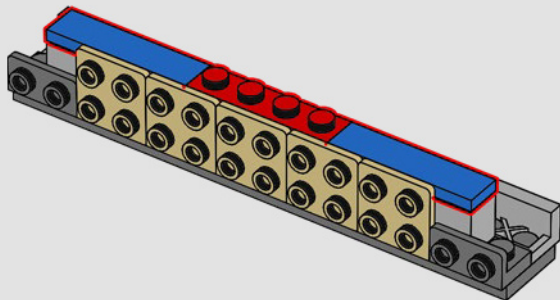

331

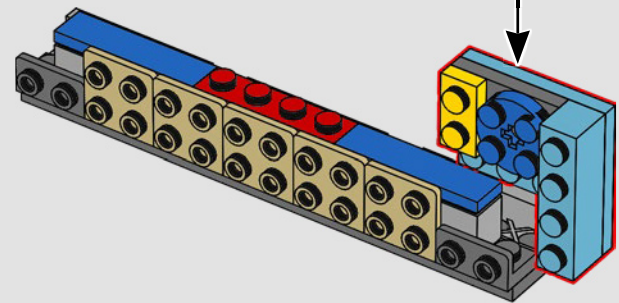
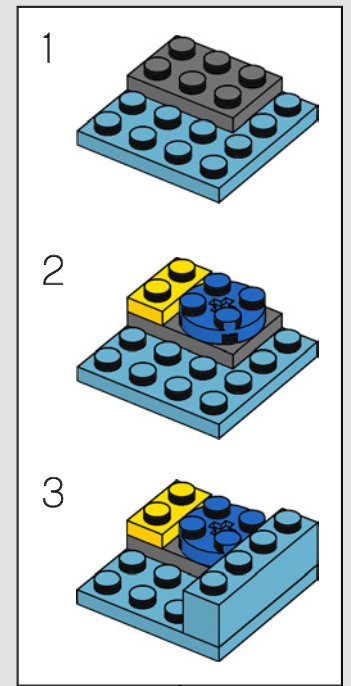

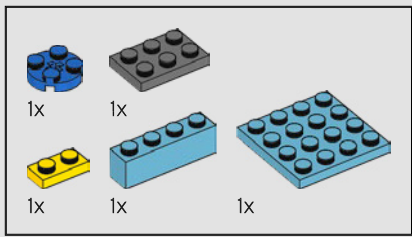

332

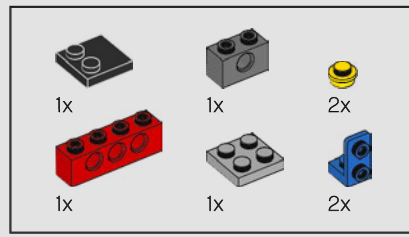
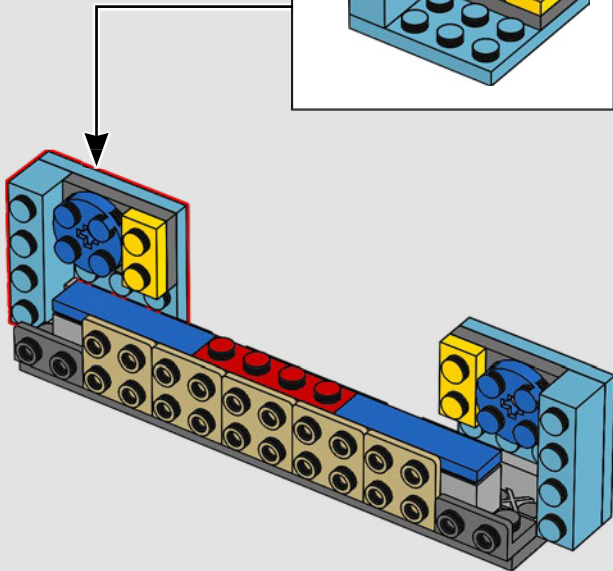
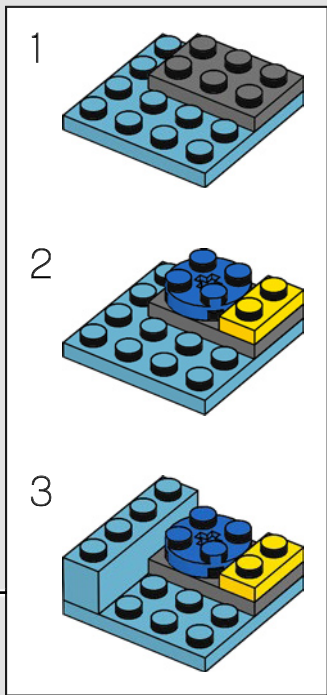

333

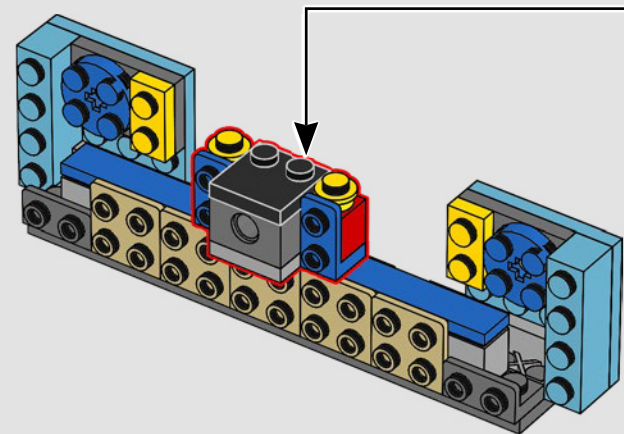
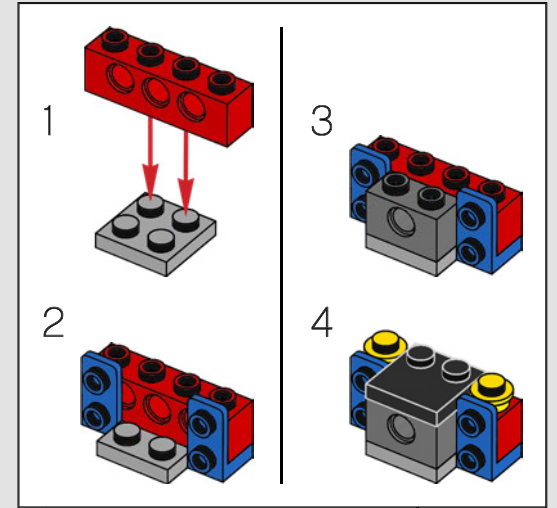



334

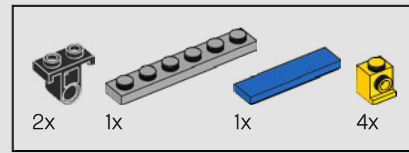
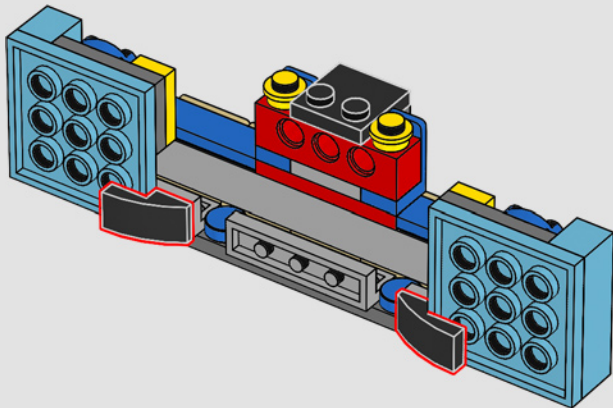

335

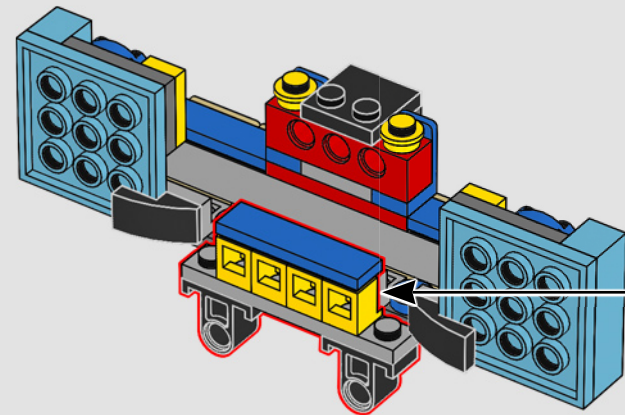
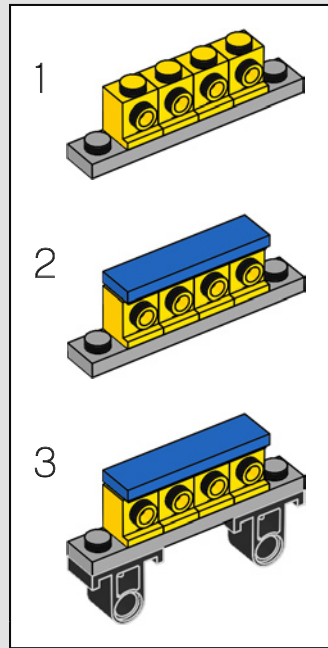

336

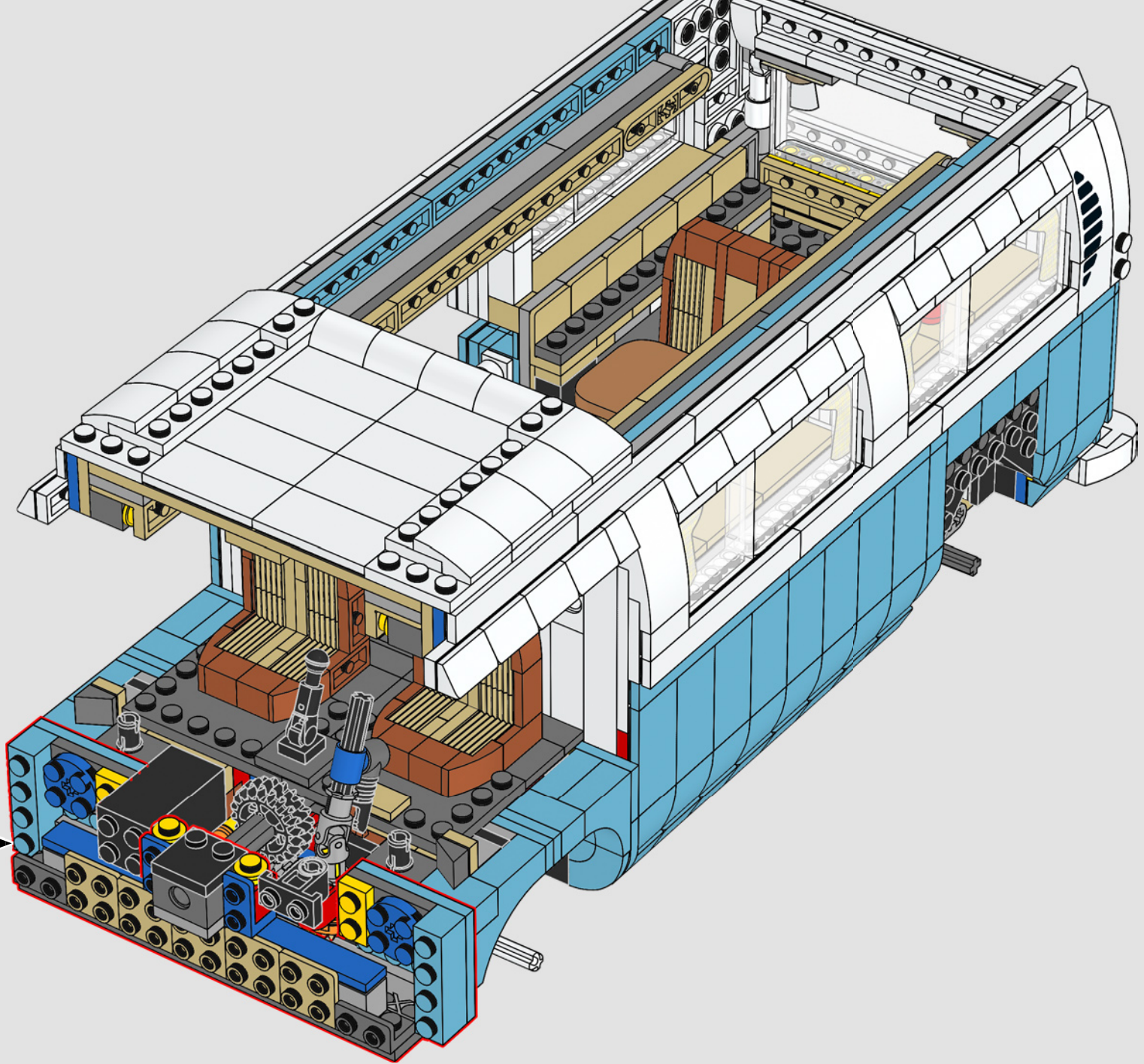

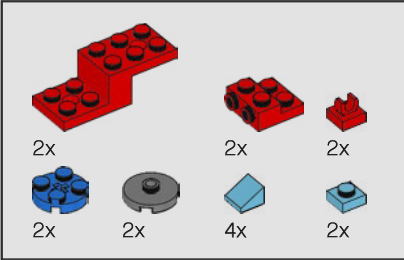
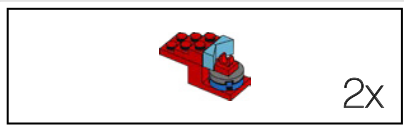

337

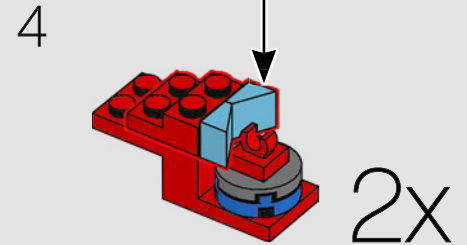
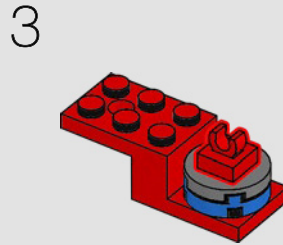
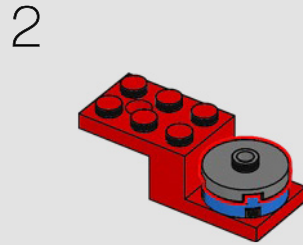
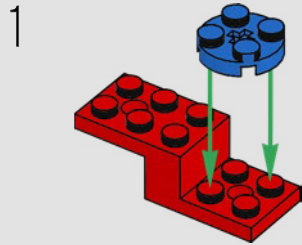
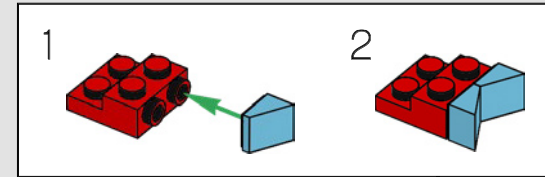

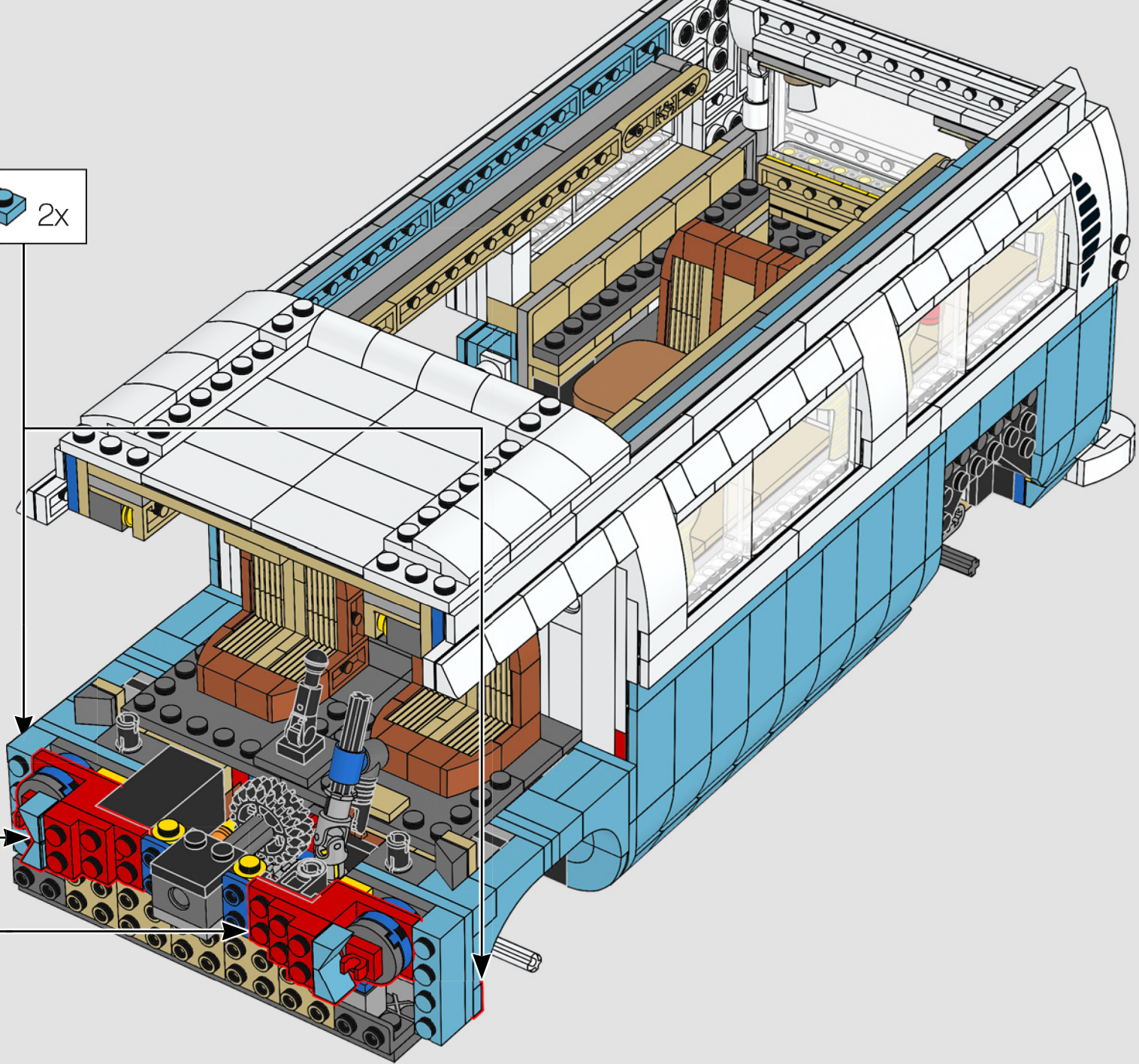
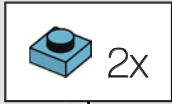

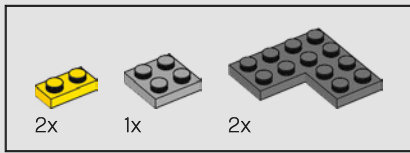

338

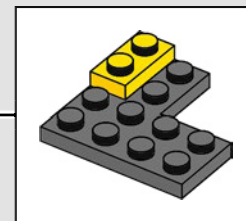
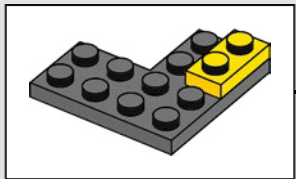
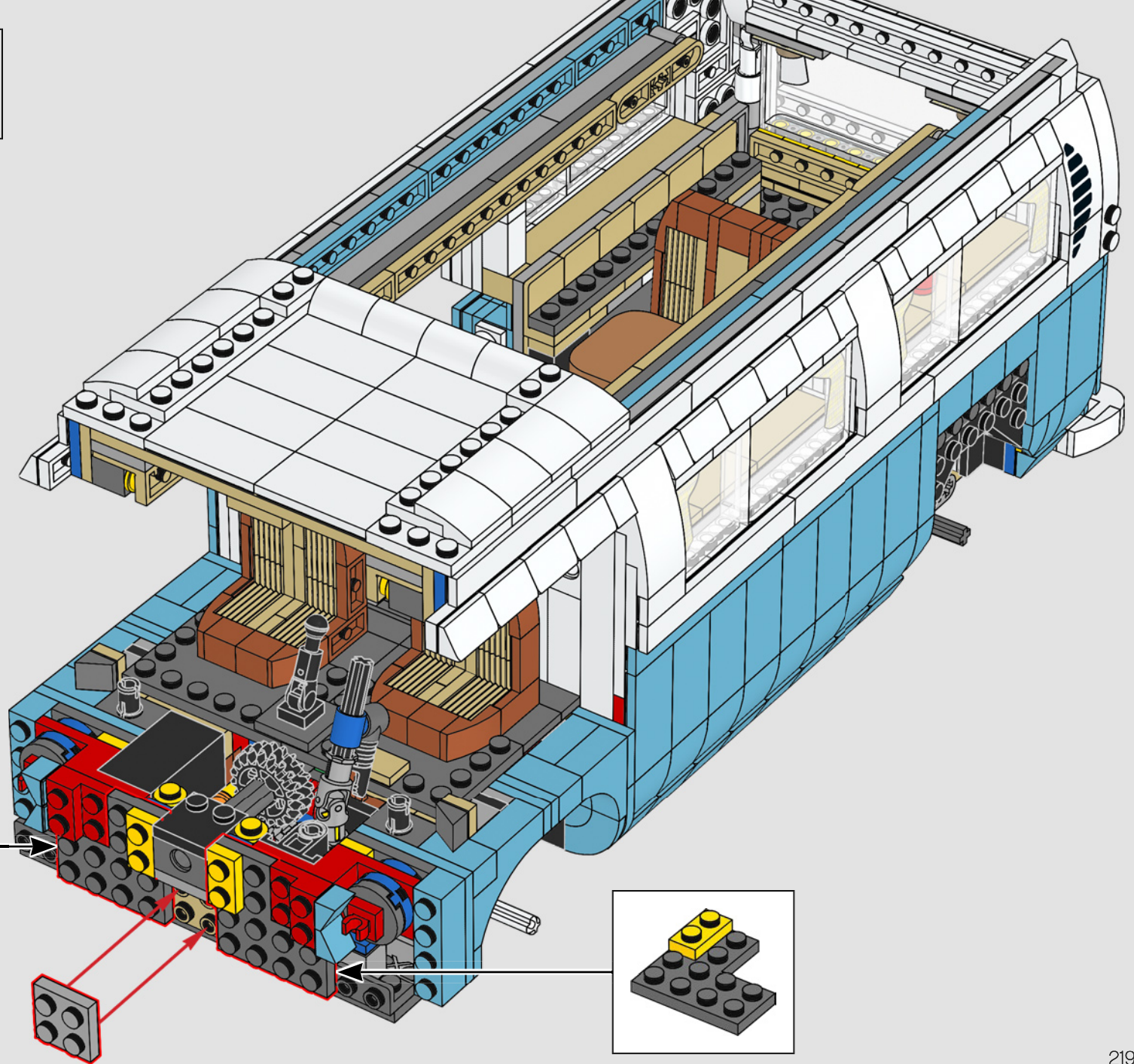

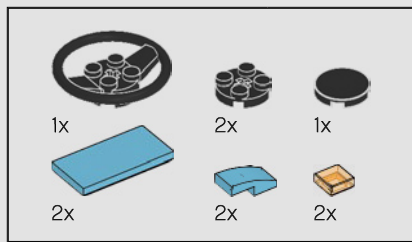

339

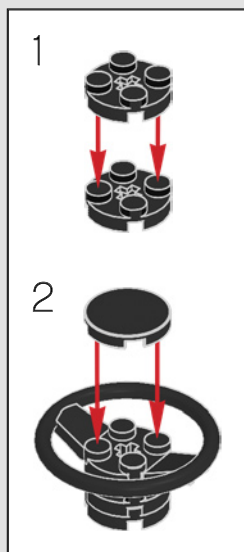
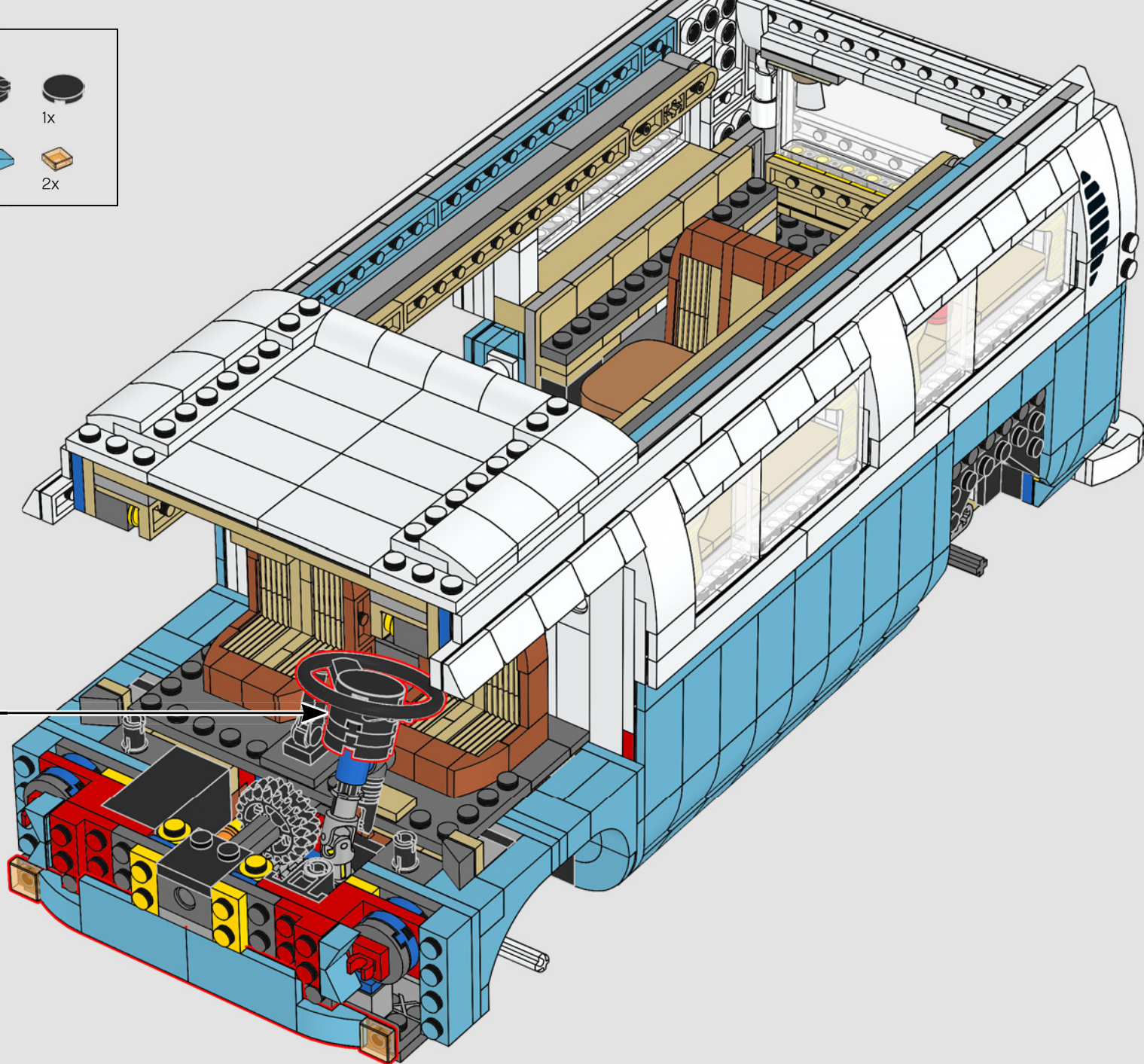

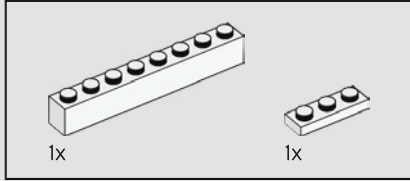
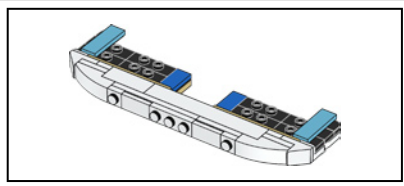

340

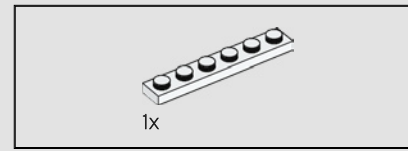
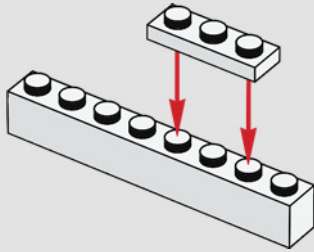

341

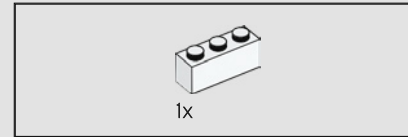
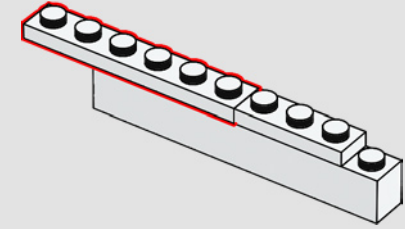

342

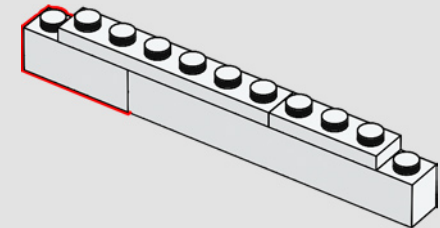

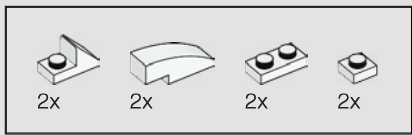

343

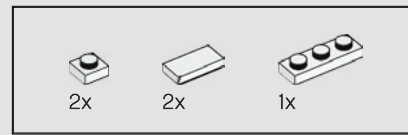
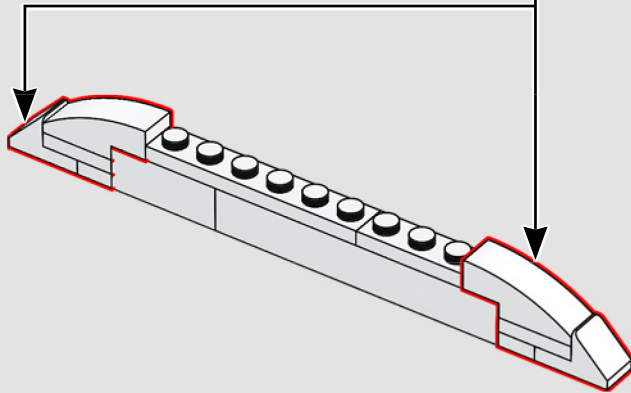
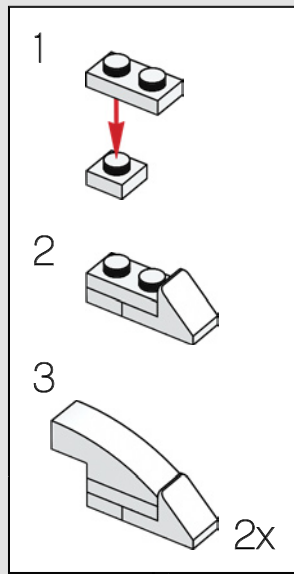

344

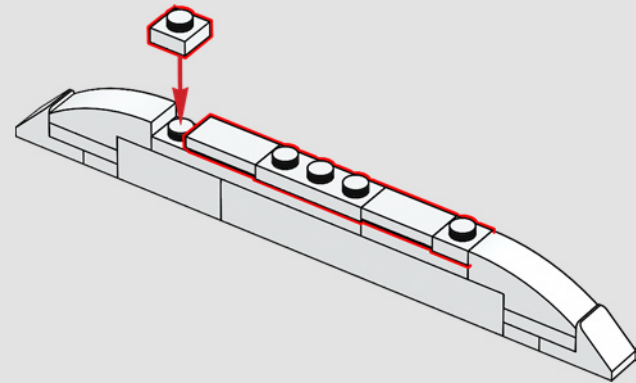

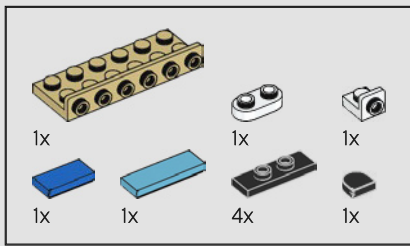

345

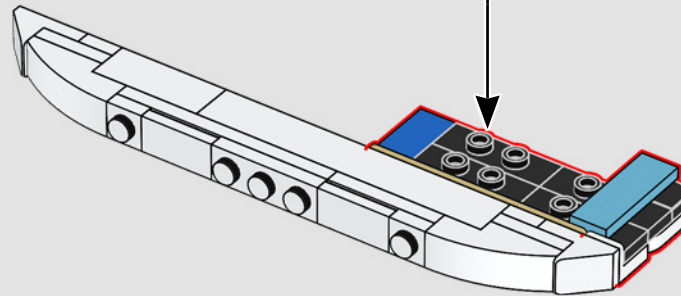
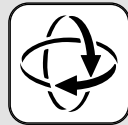
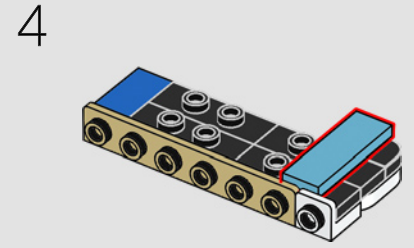
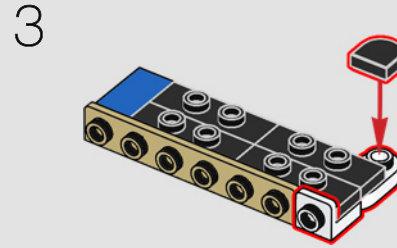
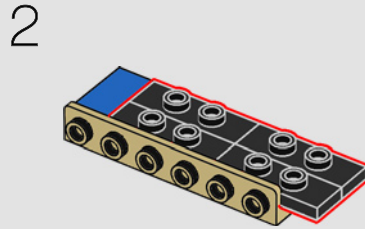
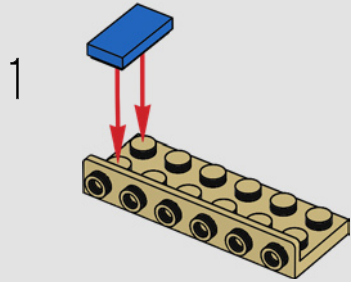

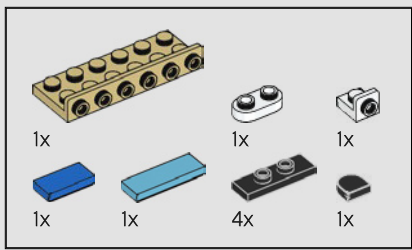

346

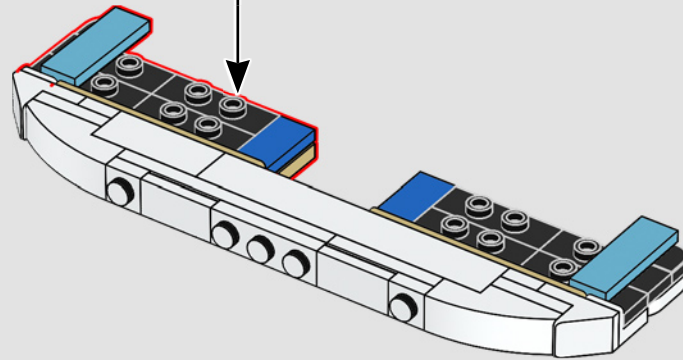
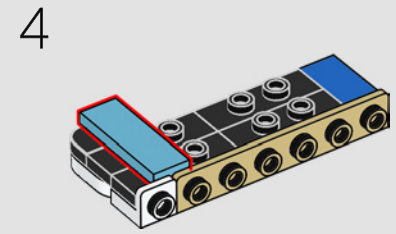
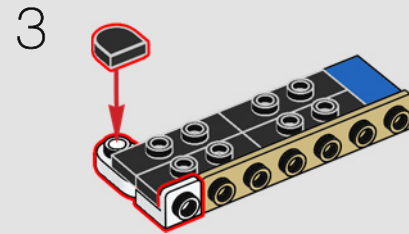
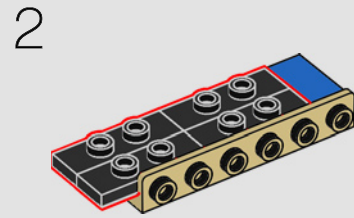
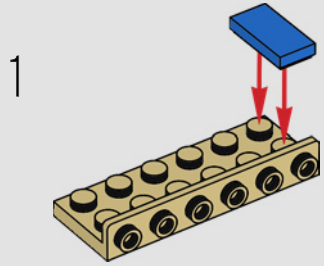



347

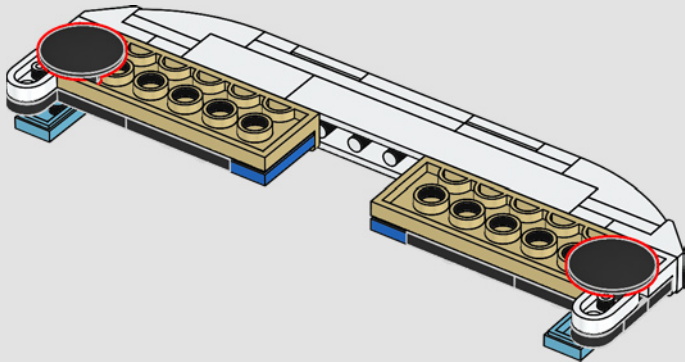

348

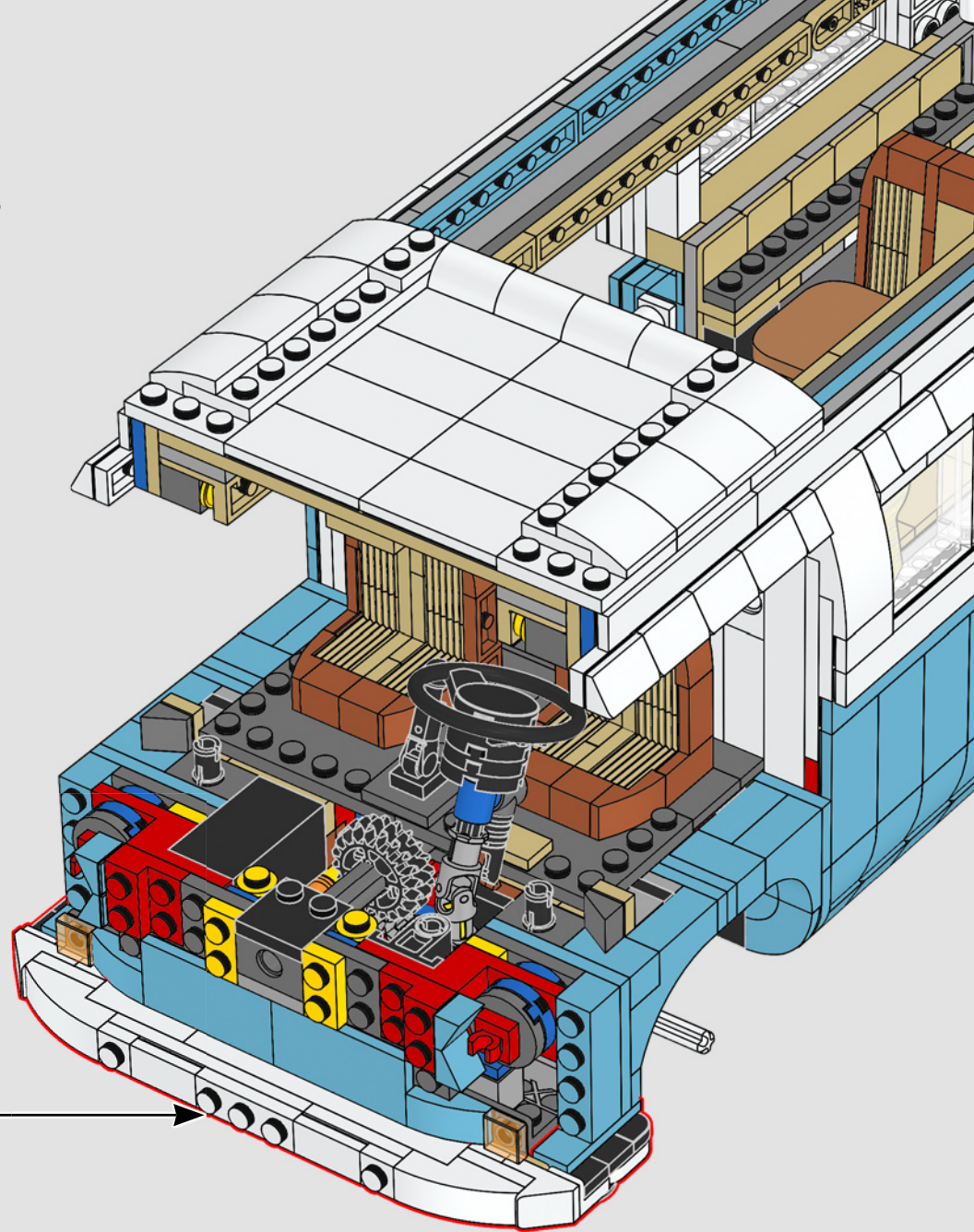

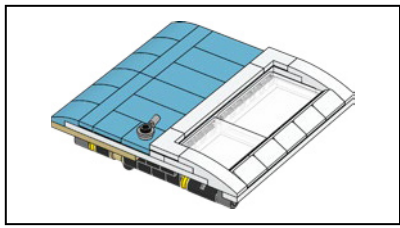

Mentre la maggior parte dei transporter VW era dotato di portellone scorrevole sul lato passeggero, era anche disponibile una versione con un portellone su entrambi i lati. Questi modelli venivano utilizzati principalmente come autopompe e per la consegna della posta.

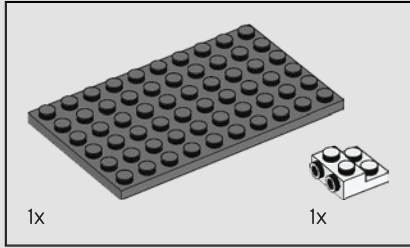

349

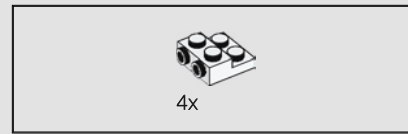
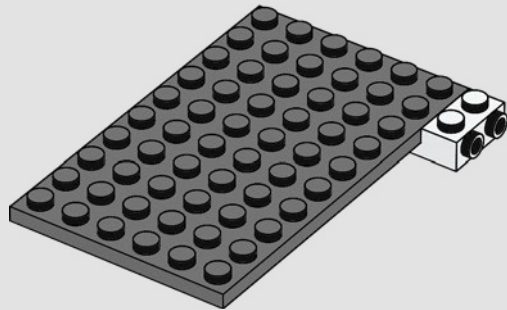

350

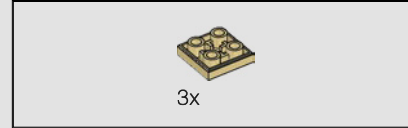
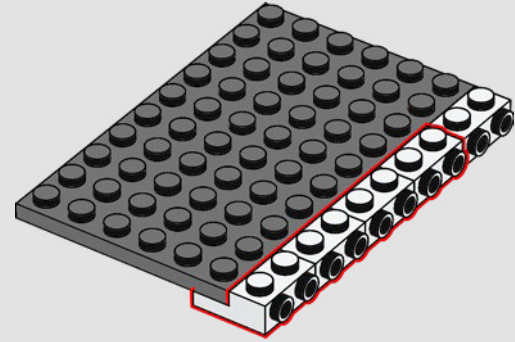

351

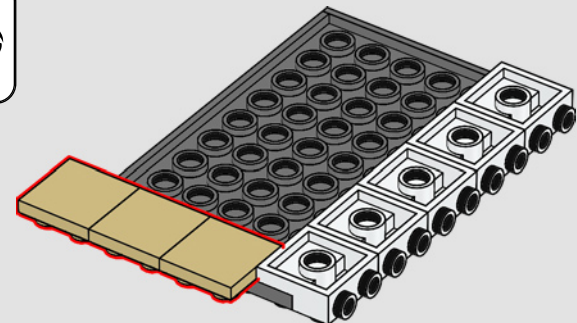
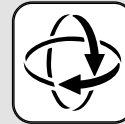

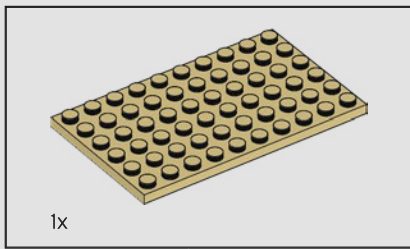

352

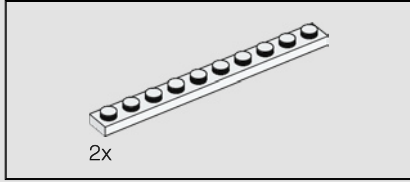
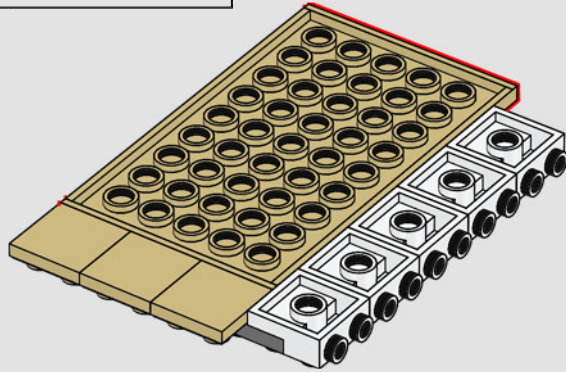

353

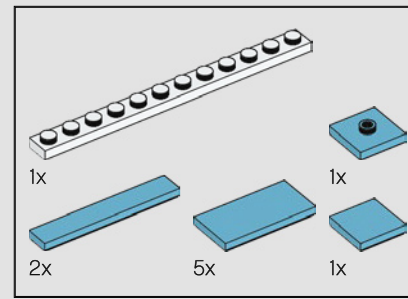
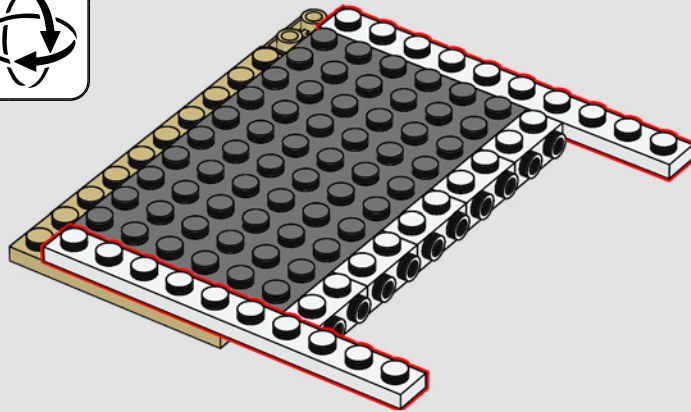

354

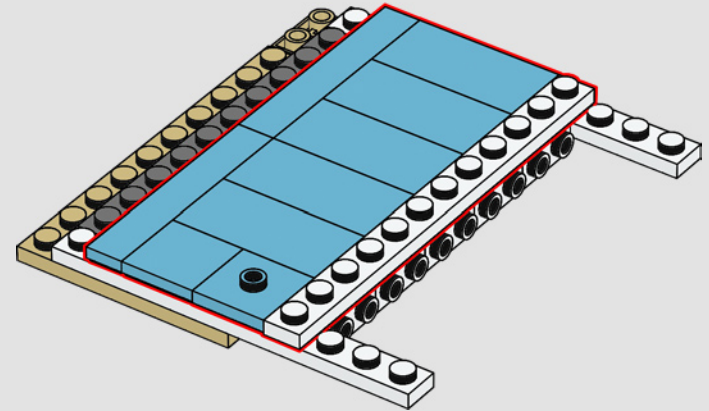

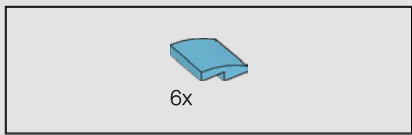

355

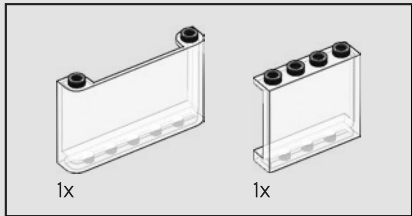
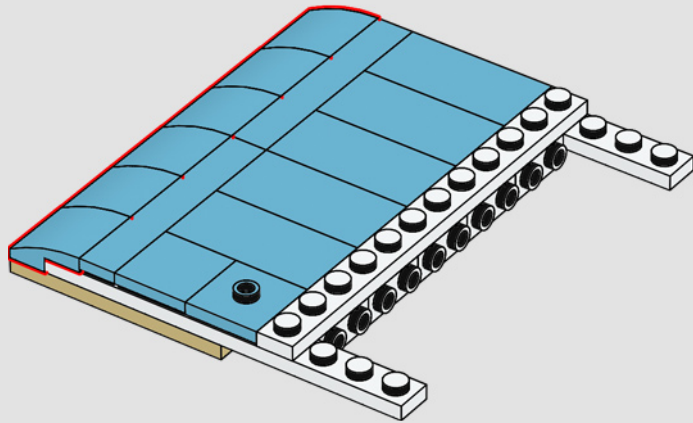

356

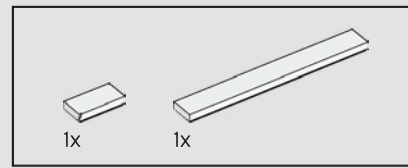
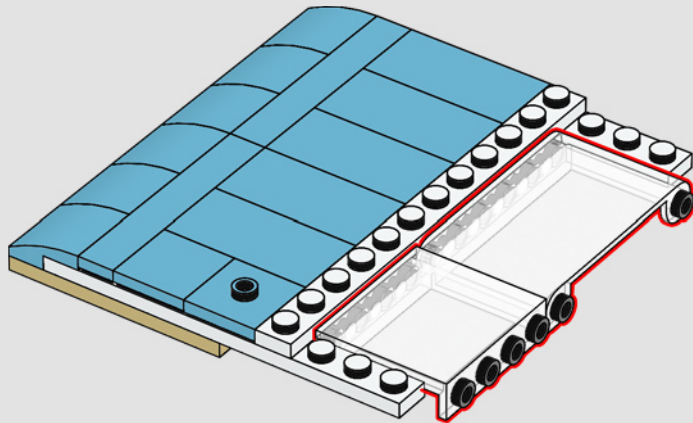

357

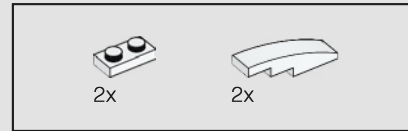
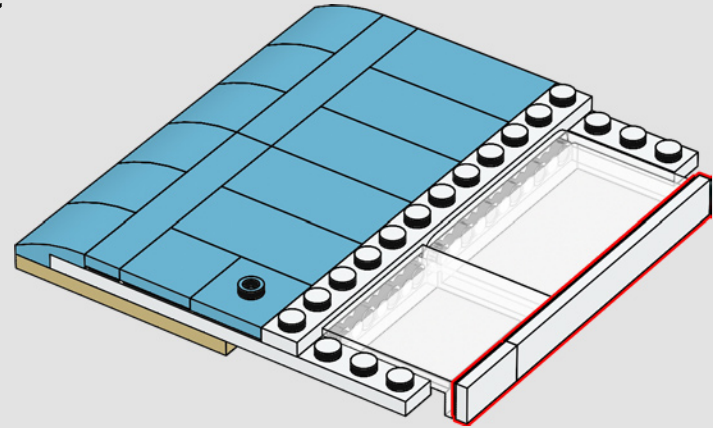

358

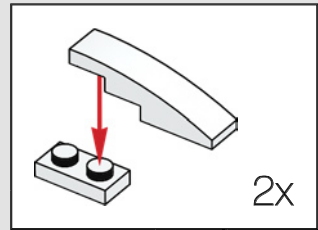
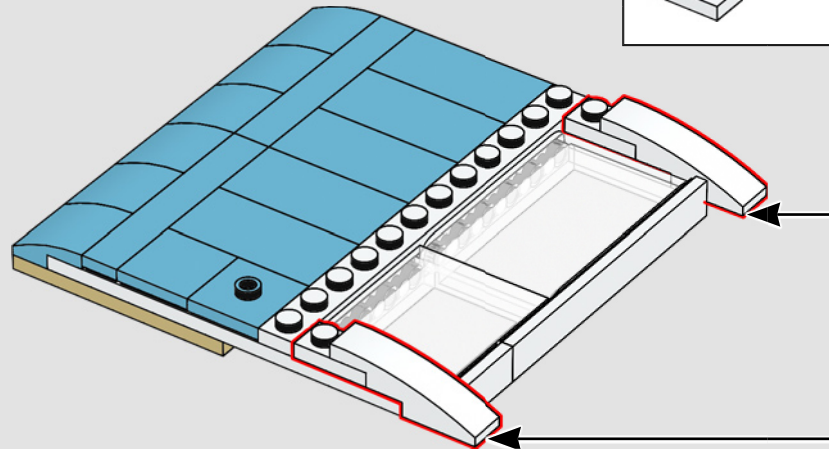

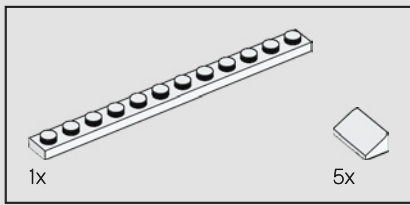

359

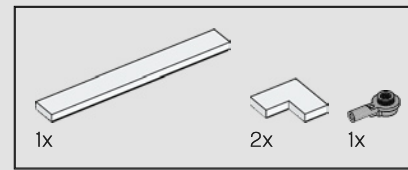
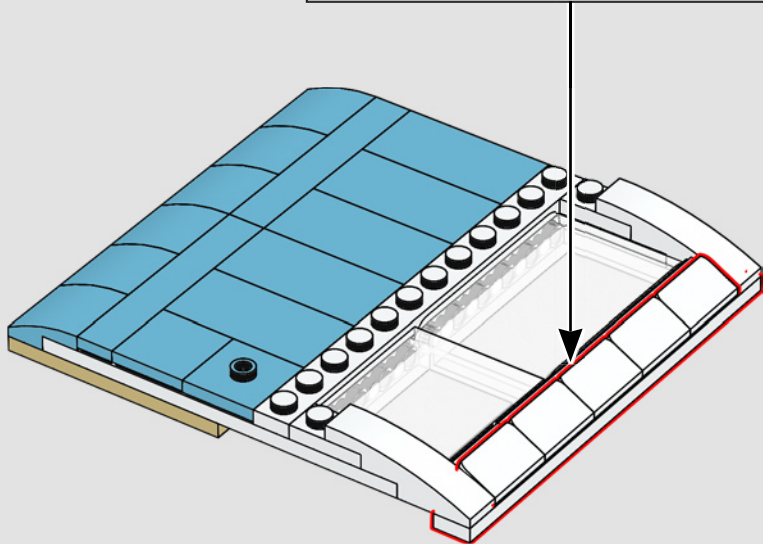
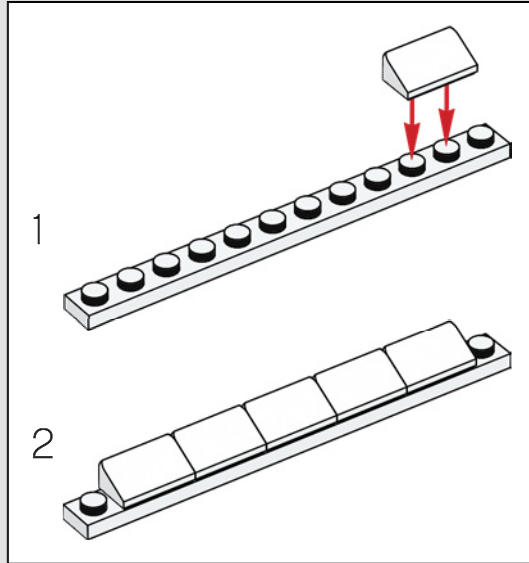

360

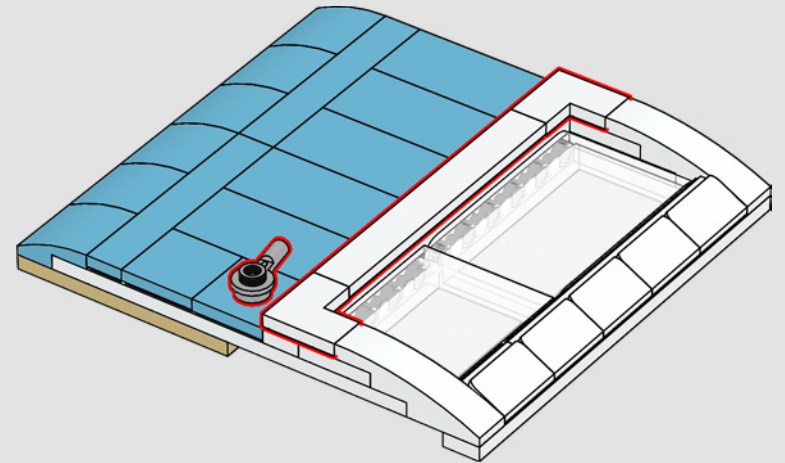

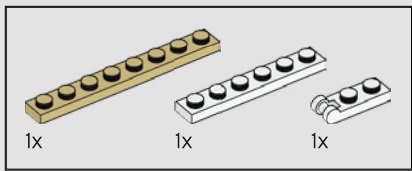

361

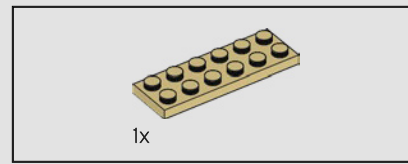
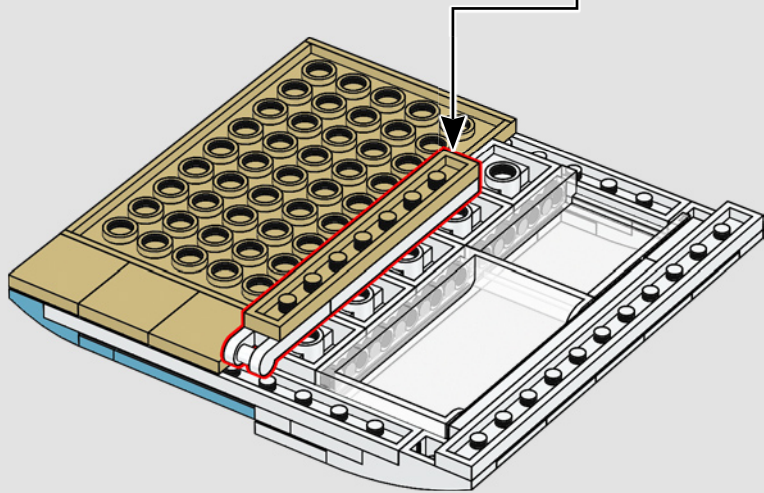
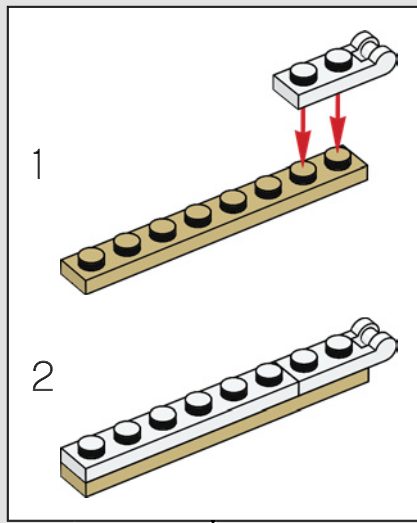

362

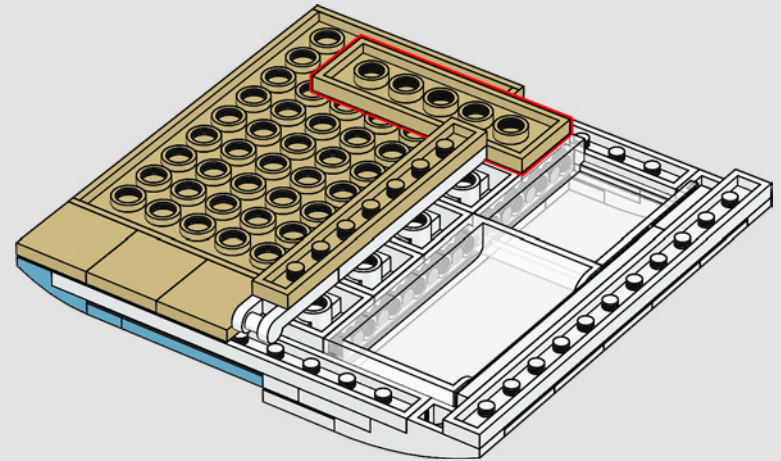

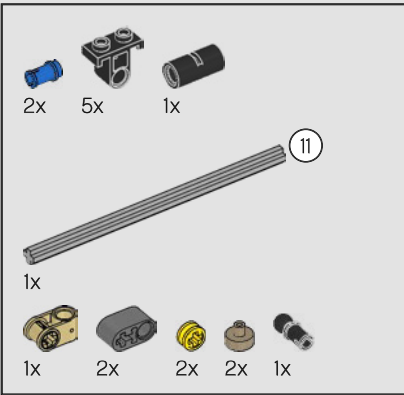
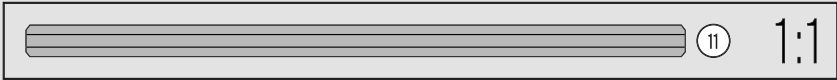
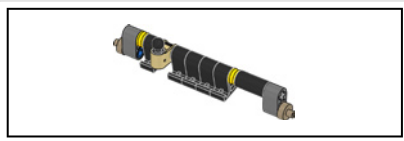

363

1

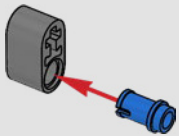

2

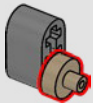

3

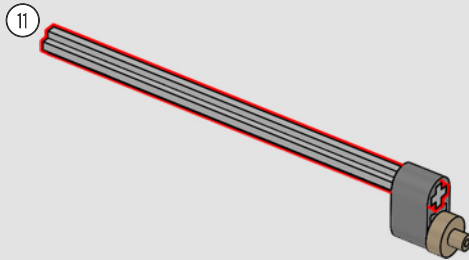

4

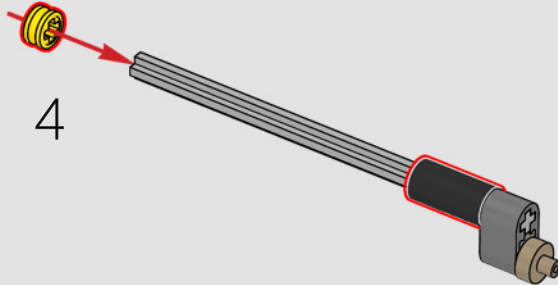

5

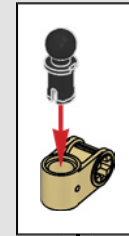
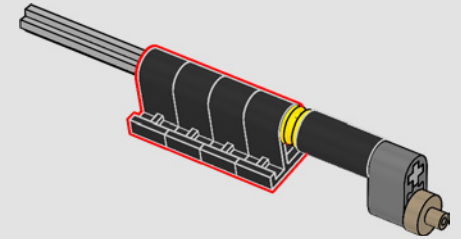

6

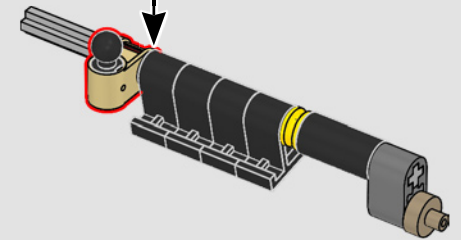

7

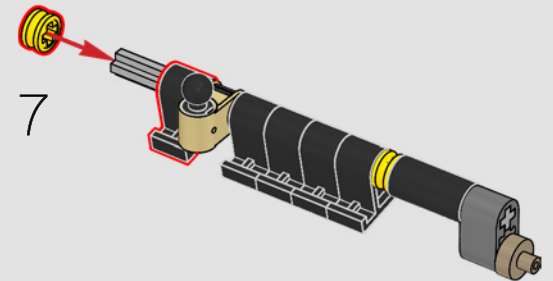

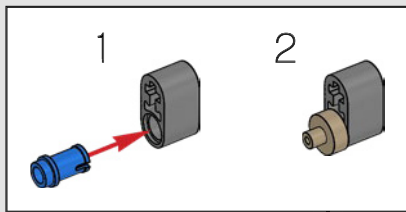

8

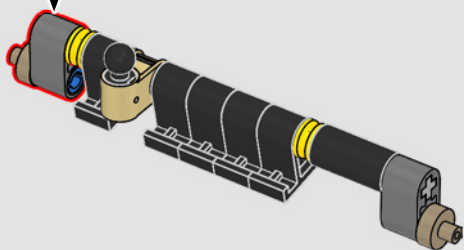

364

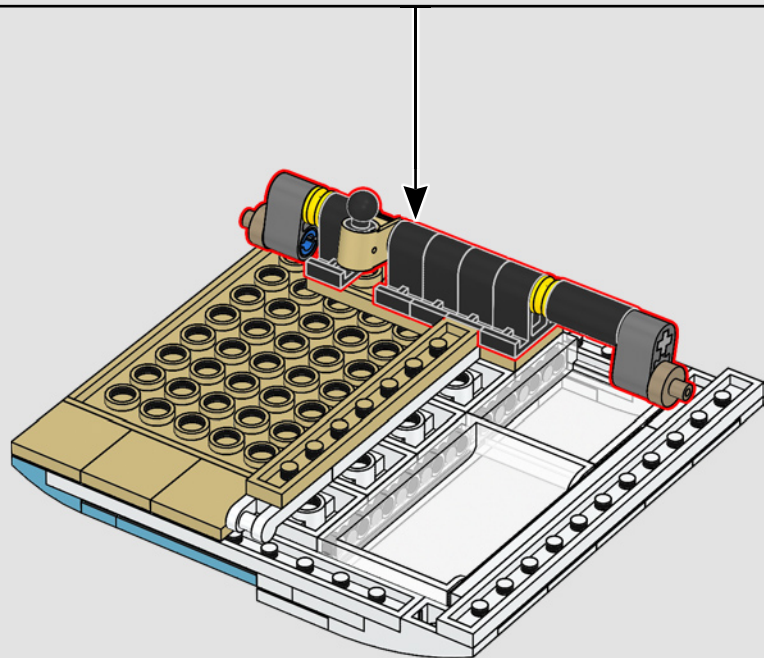
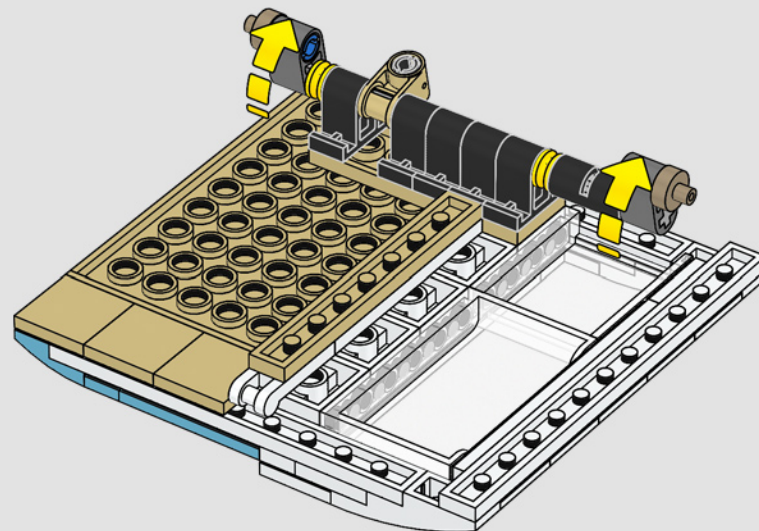

365

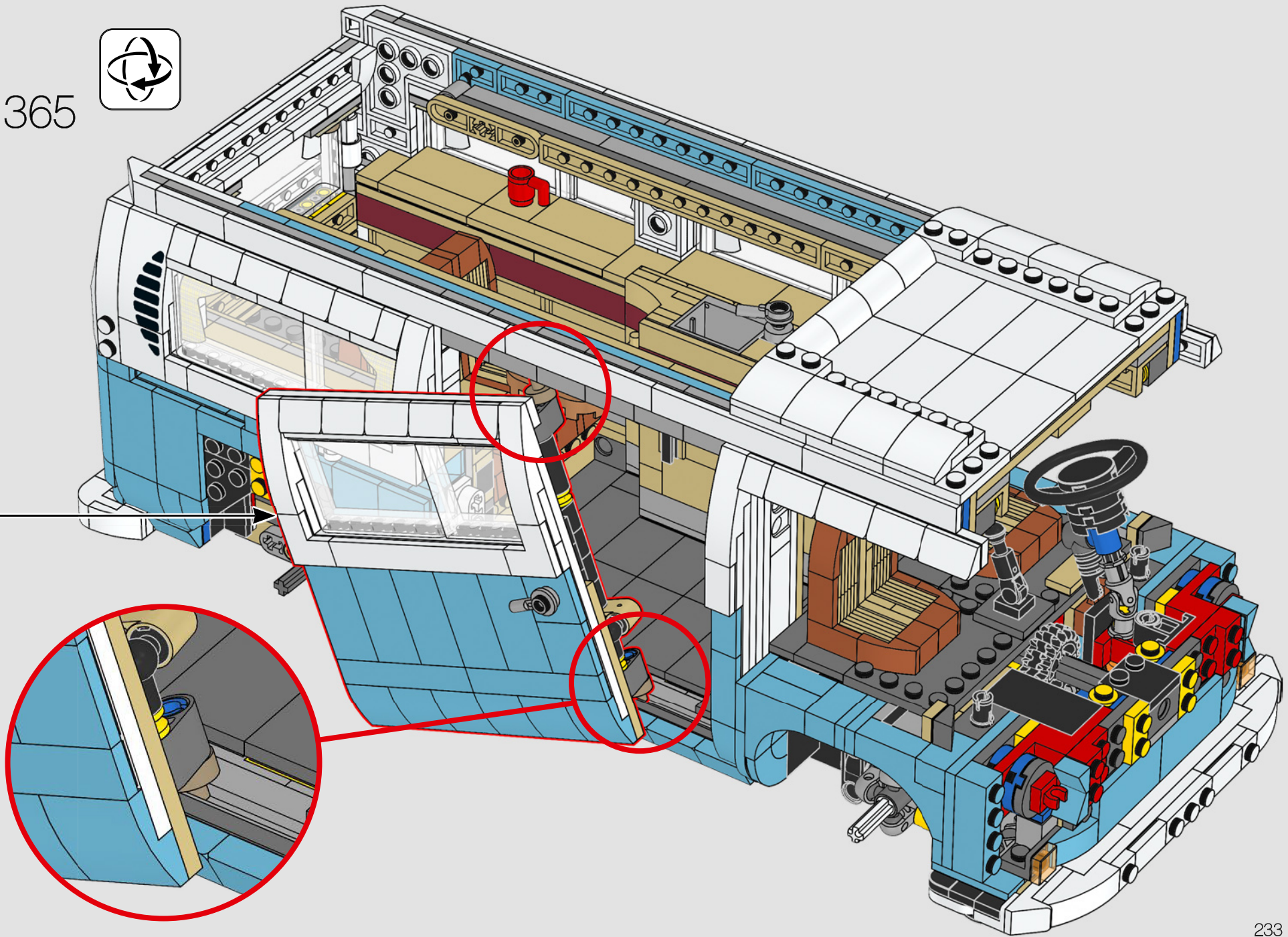

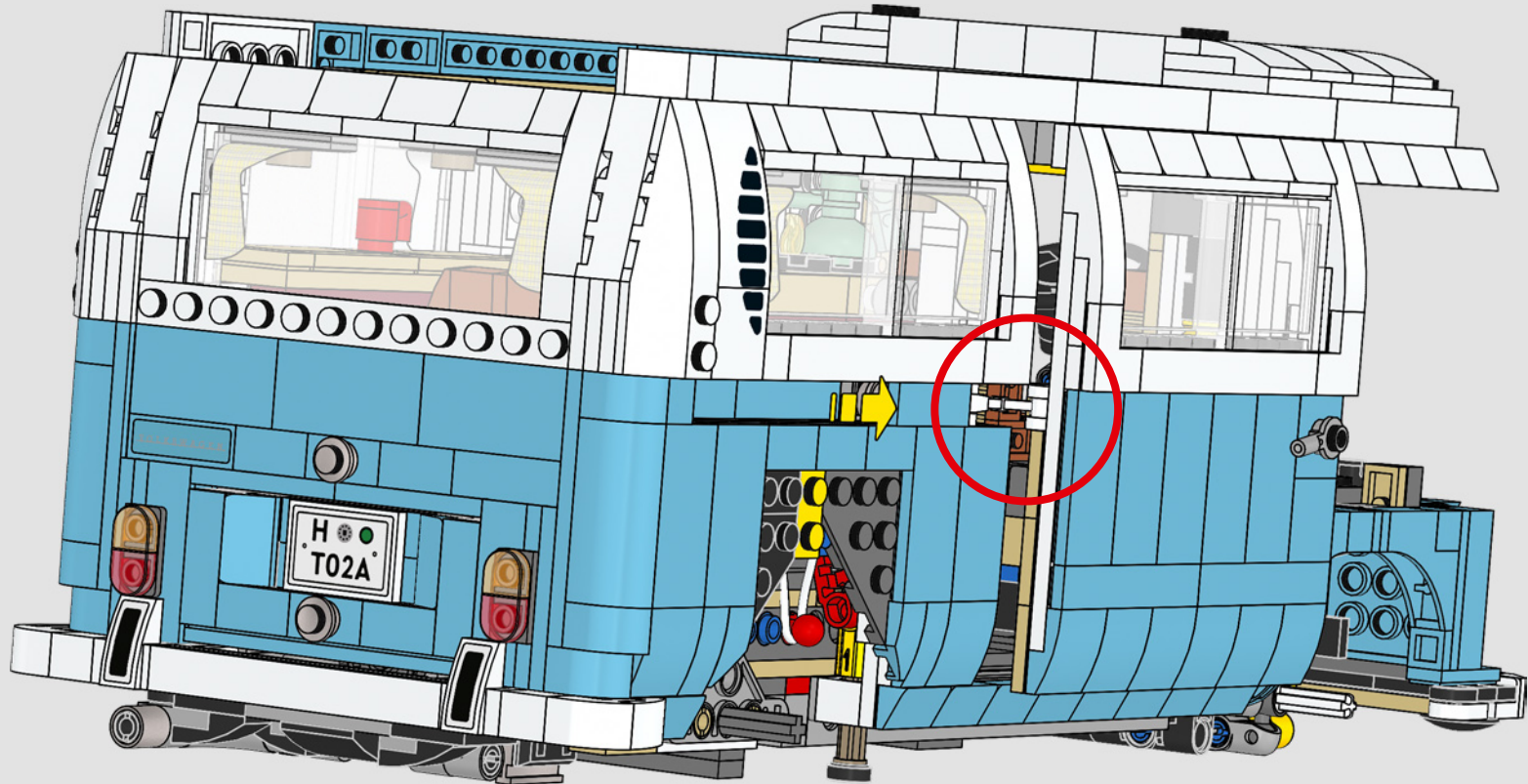

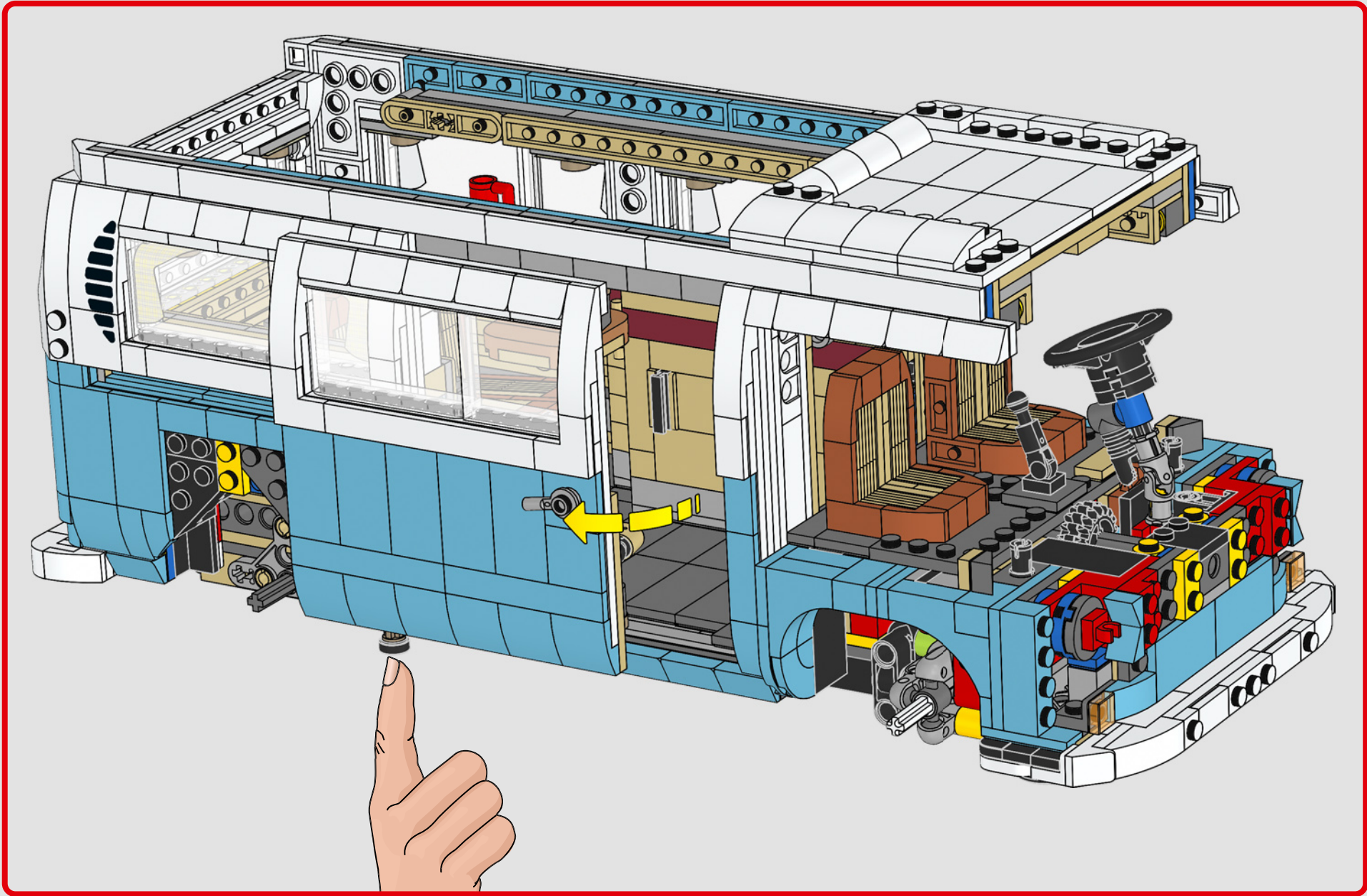



1x

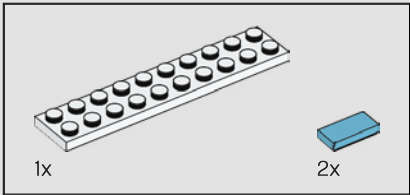
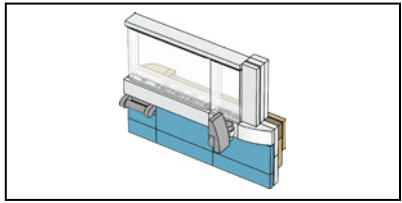
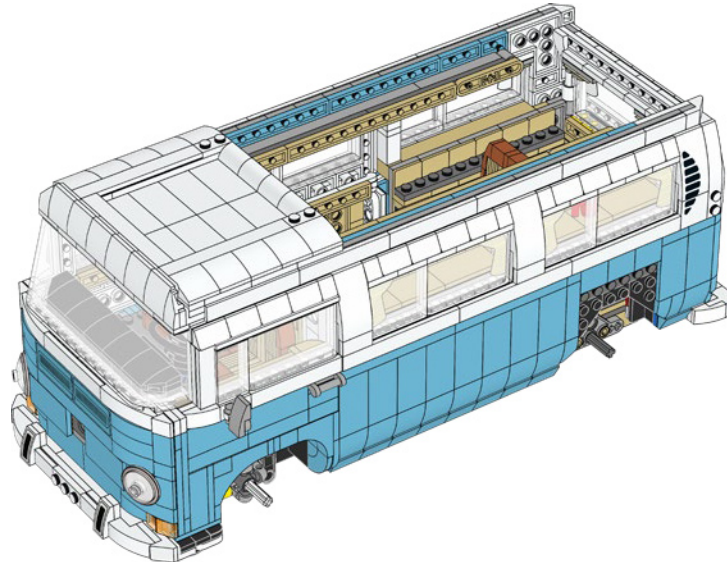
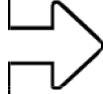

1x

2x

367

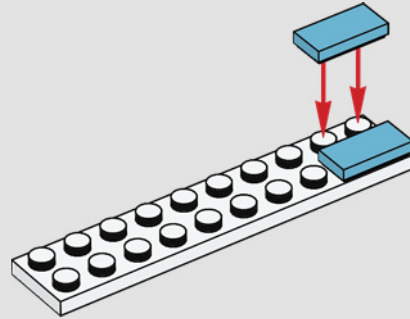

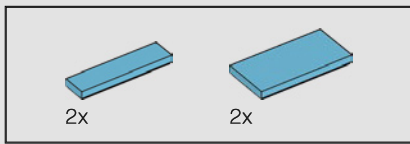

368

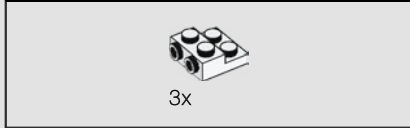
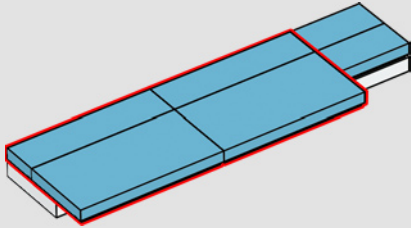

369

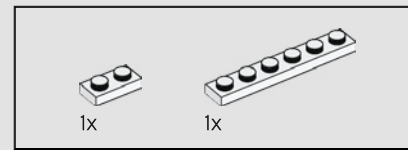
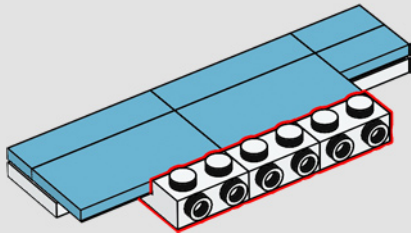

370

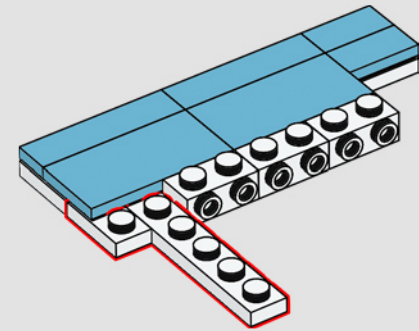

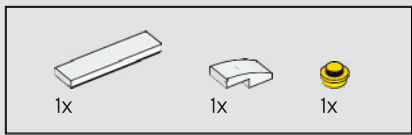

371

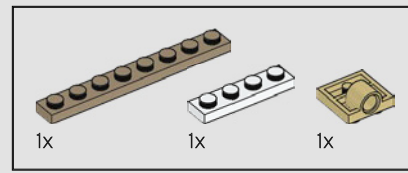
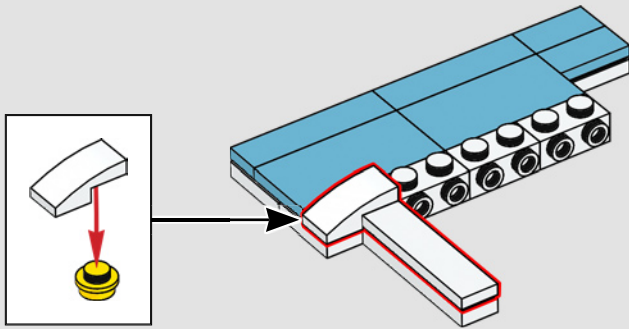

372

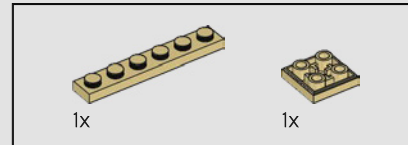
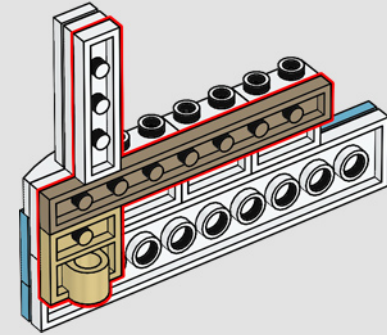
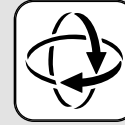

373

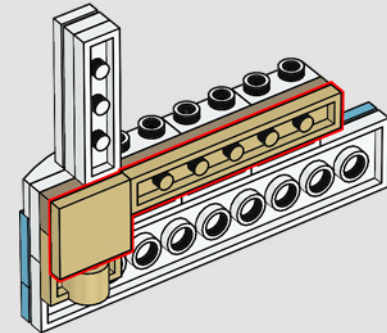

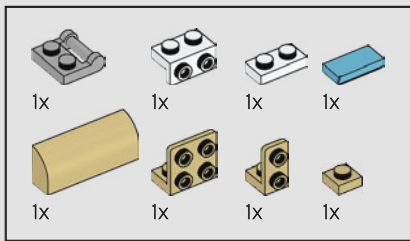

374

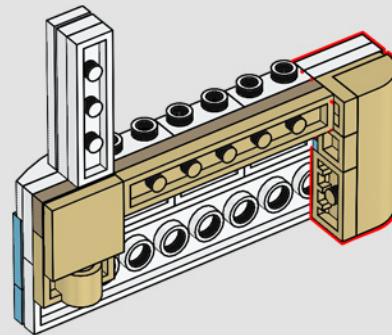
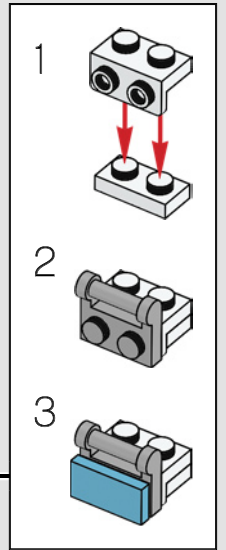
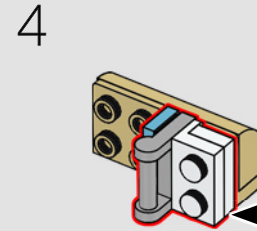
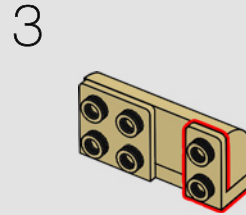
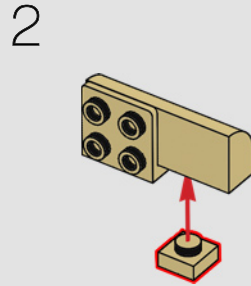
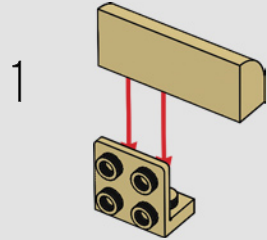

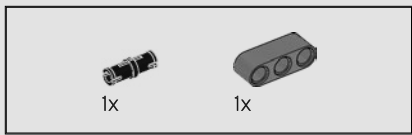

375

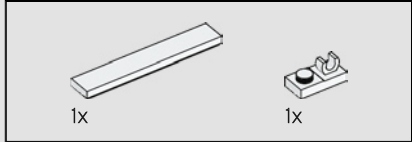
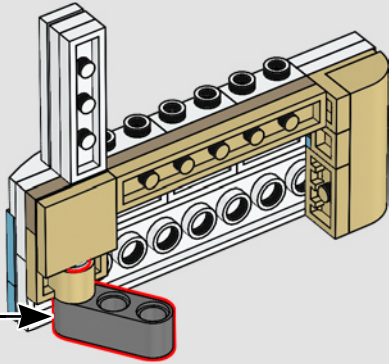
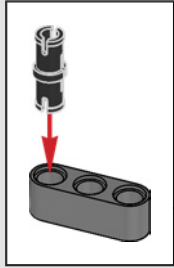

376

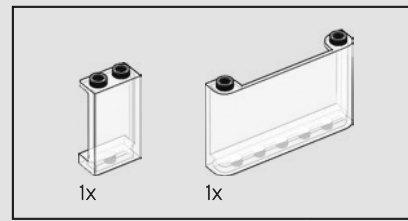
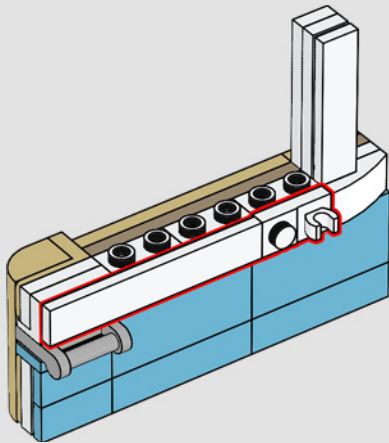

377

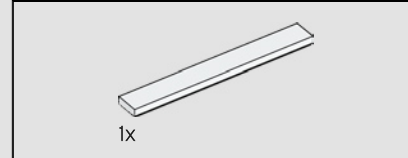
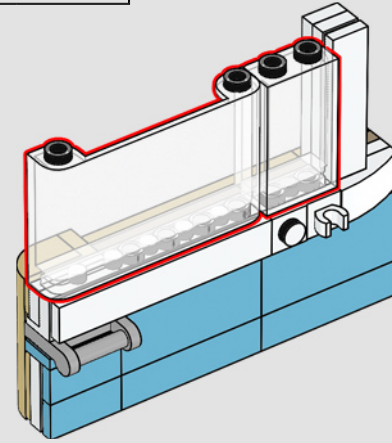

378

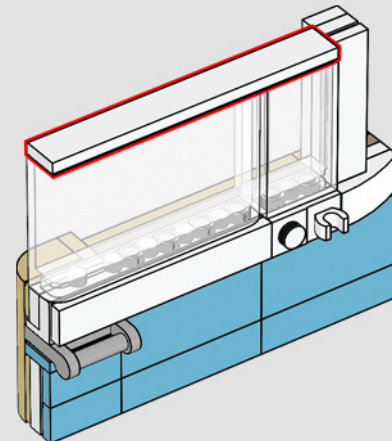

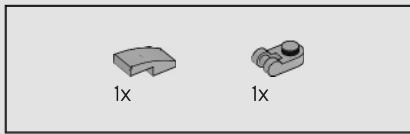

379

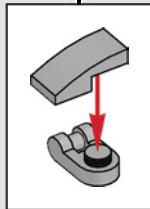
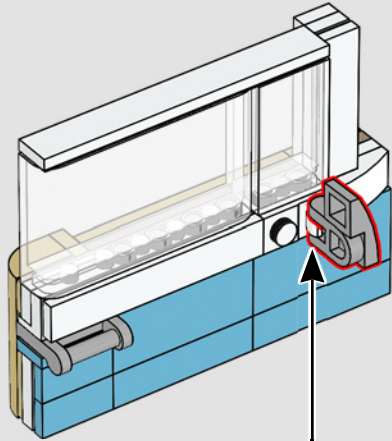

380

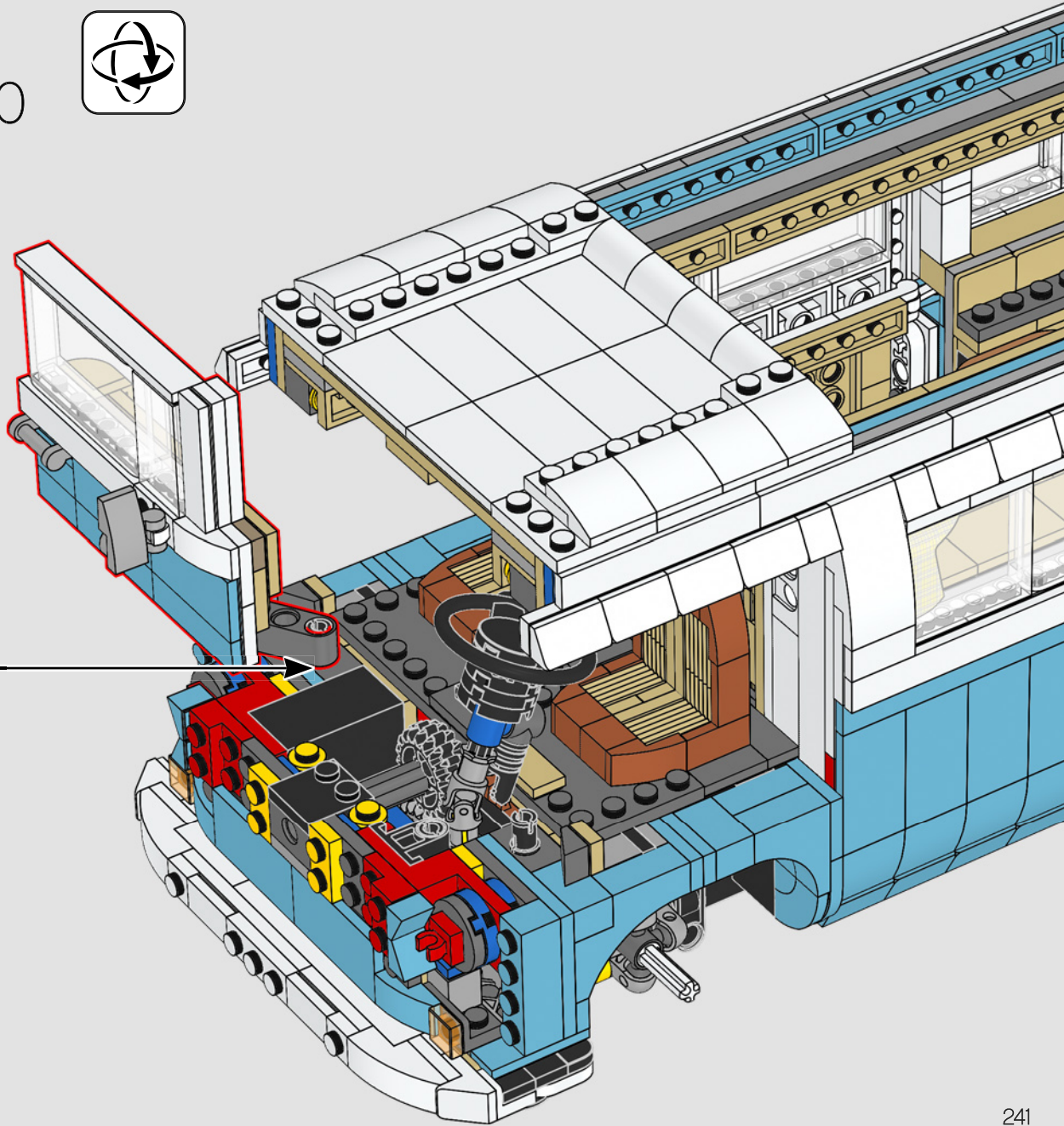

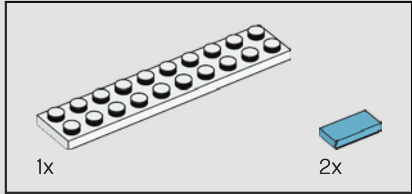
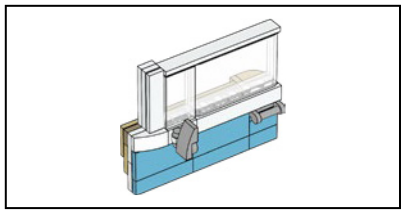

381

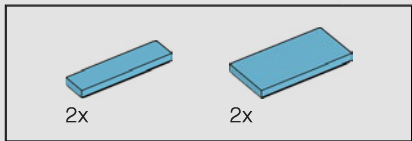
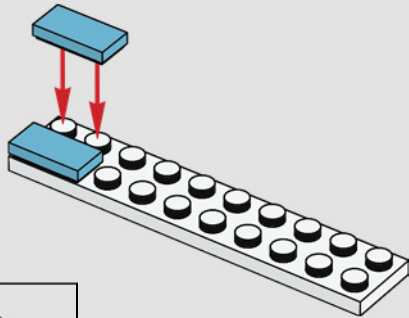

382

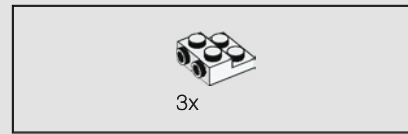
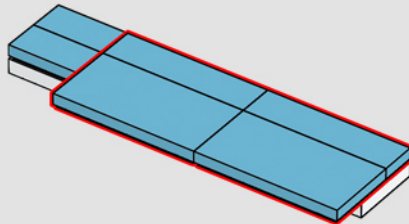

383

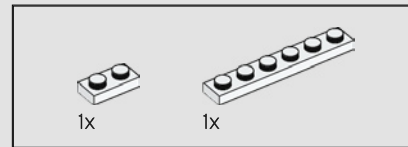
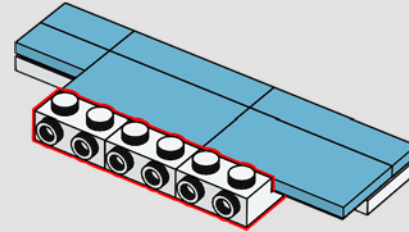

384

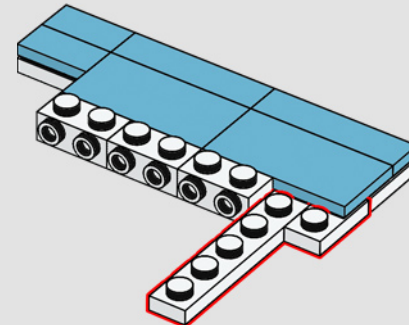

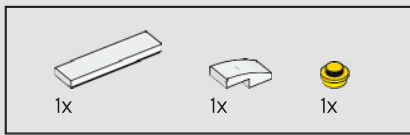

385

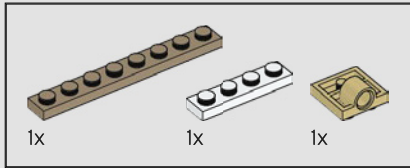
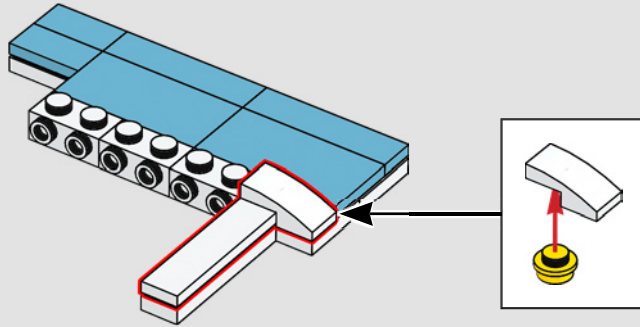

386

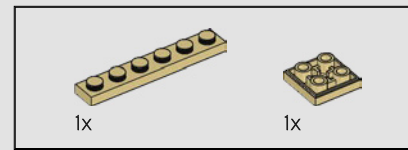
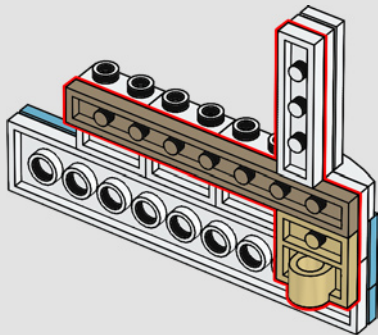

387

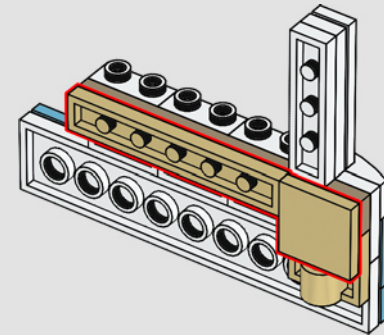

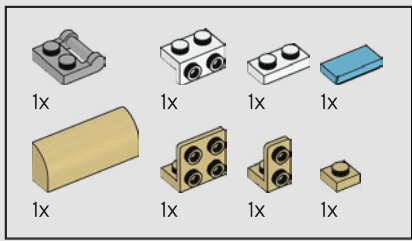

388

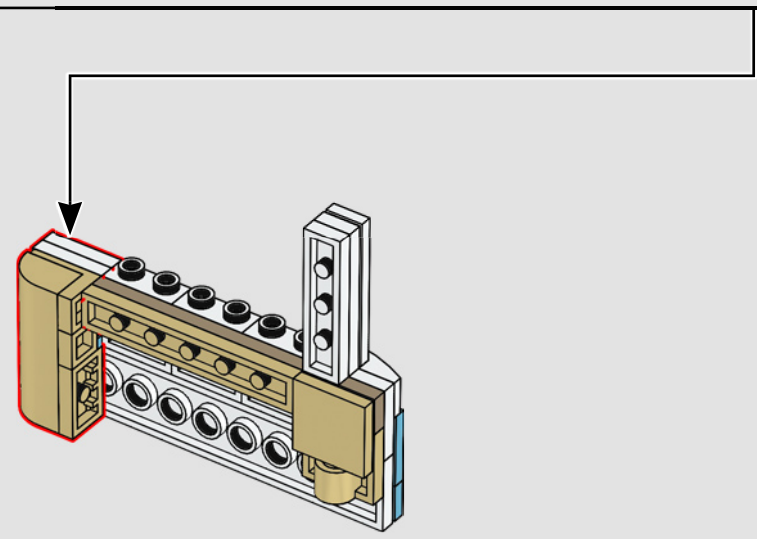
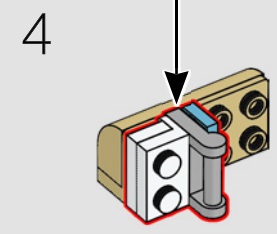
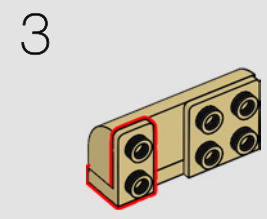
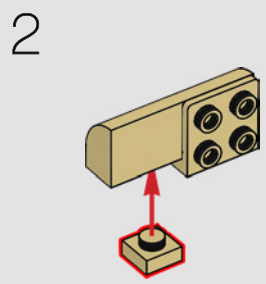
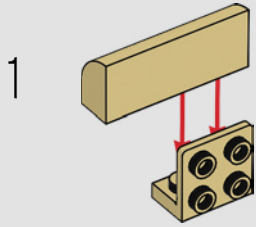
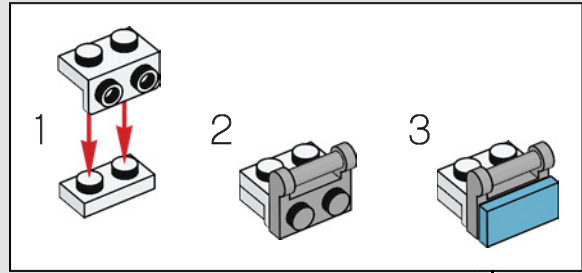

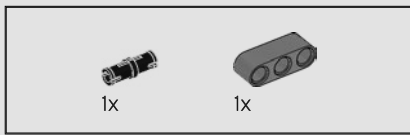

389

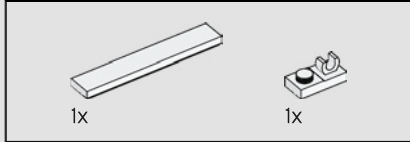
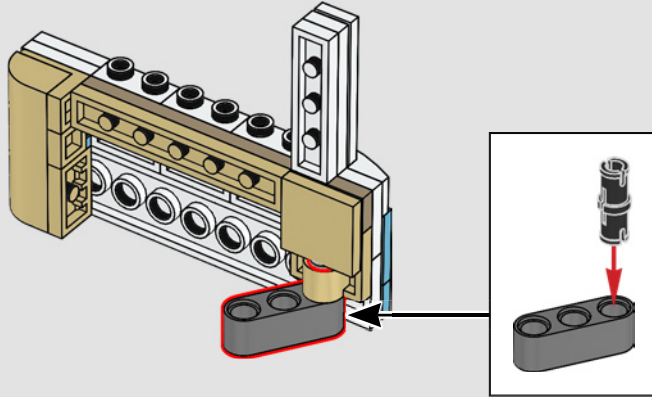

390

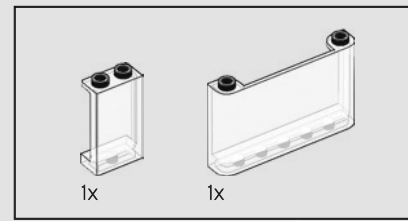
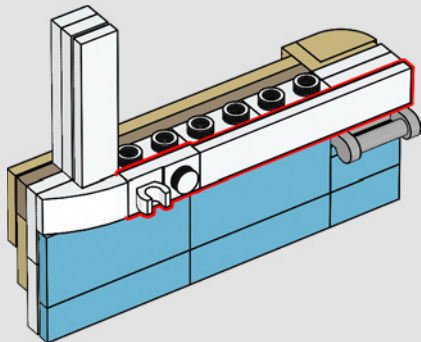

391

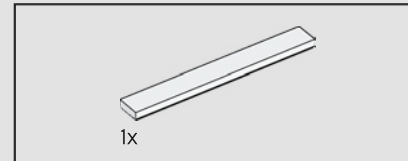
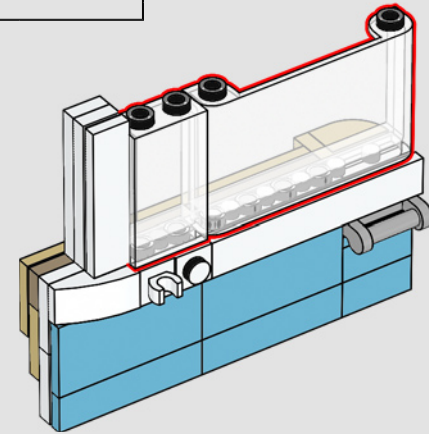

392

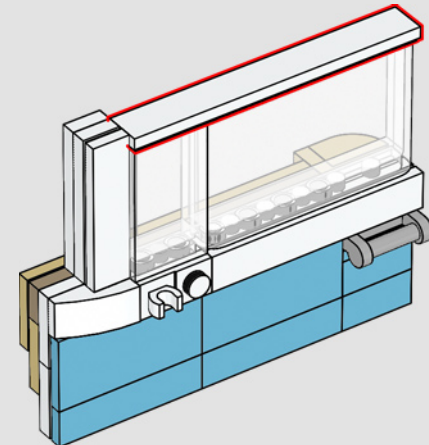

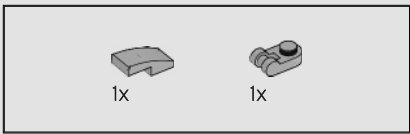

393

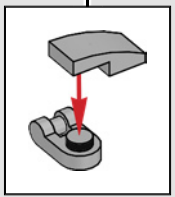
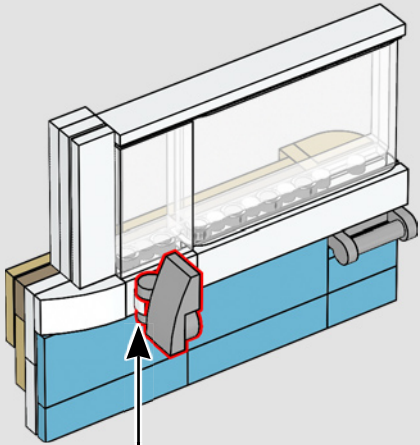

394

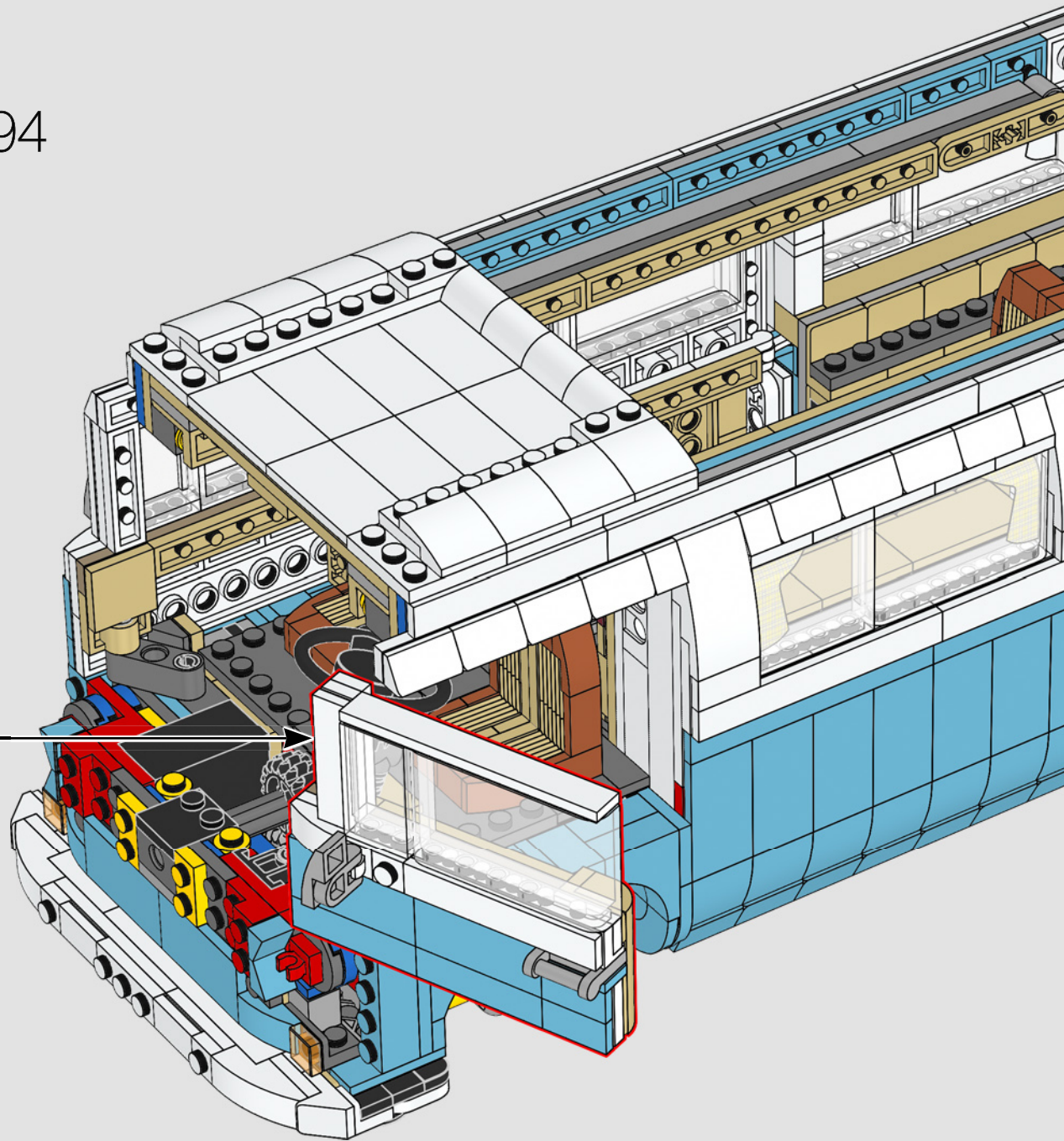

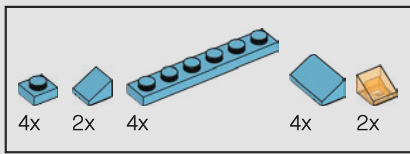

395

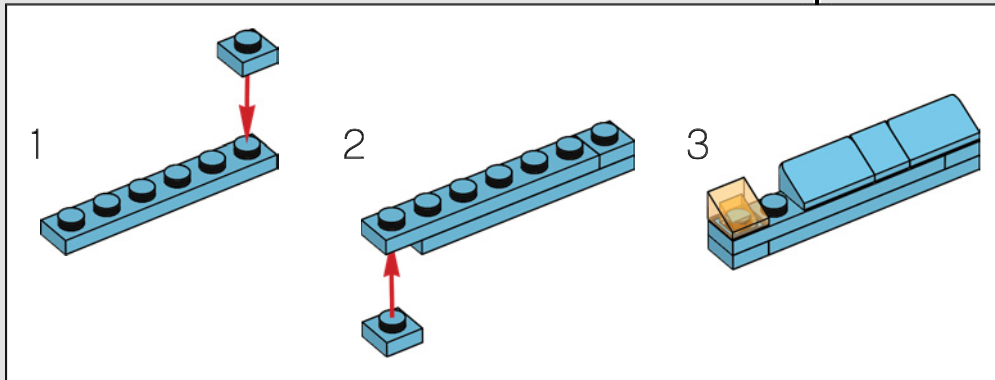
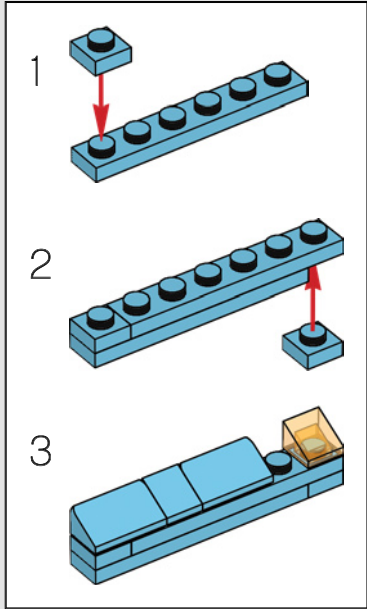

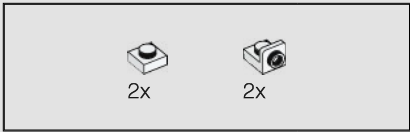

396

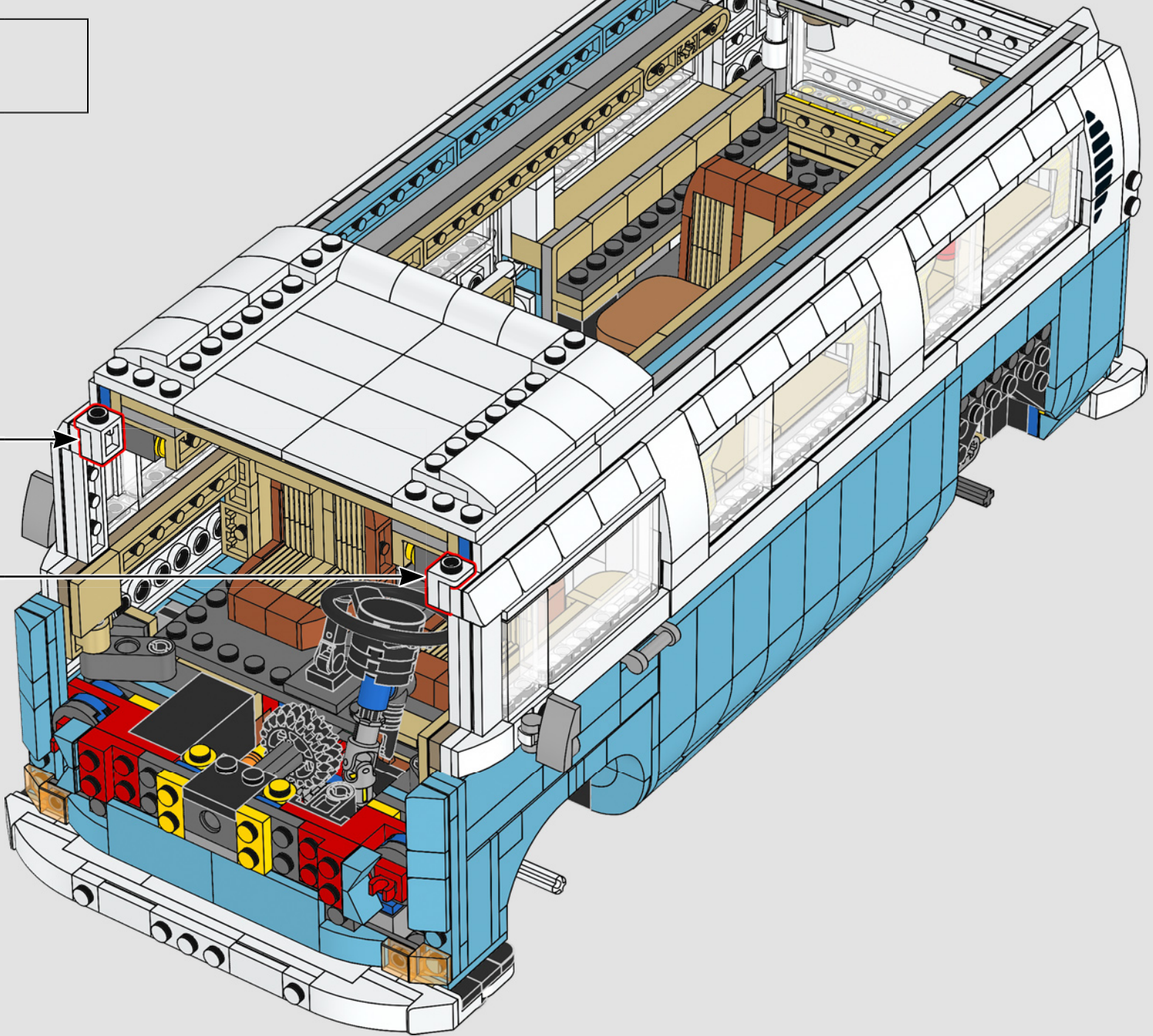
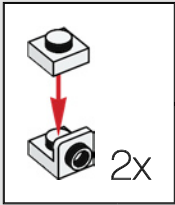

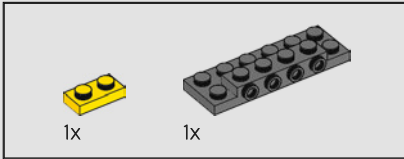
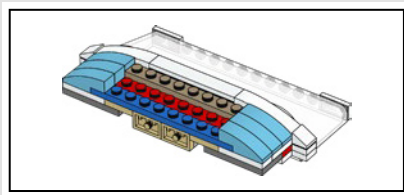

397

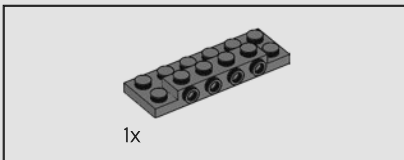
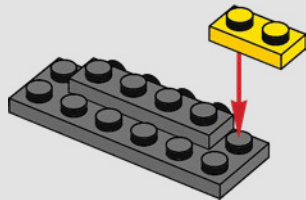

398

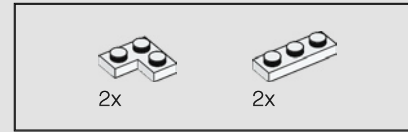
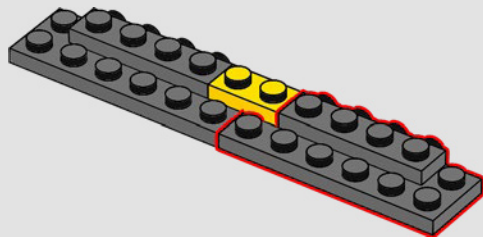

399

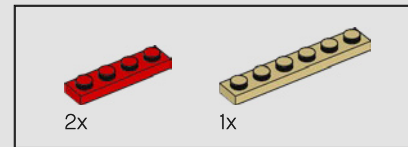
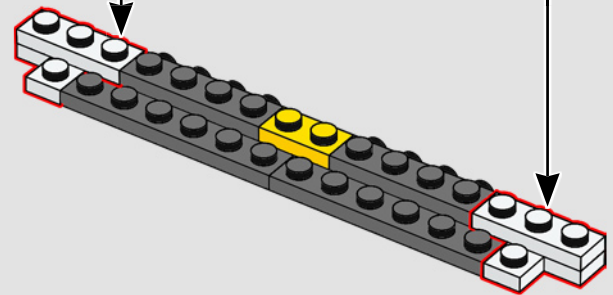
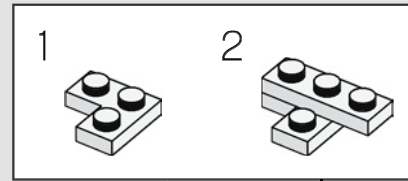
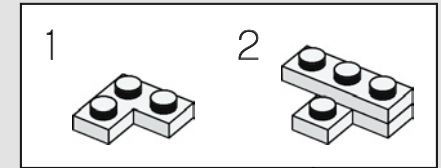

400

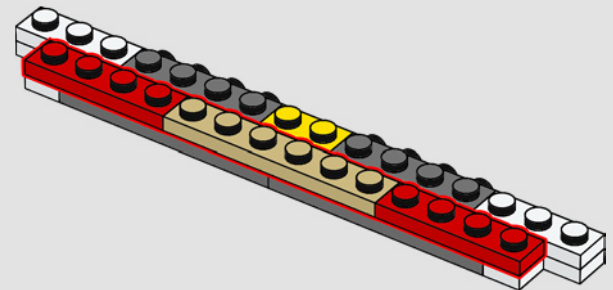

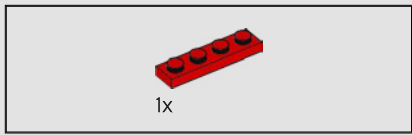

401

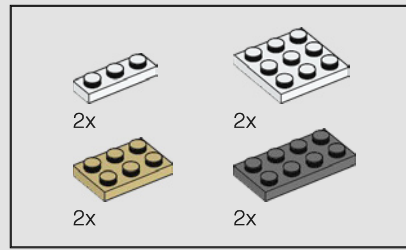
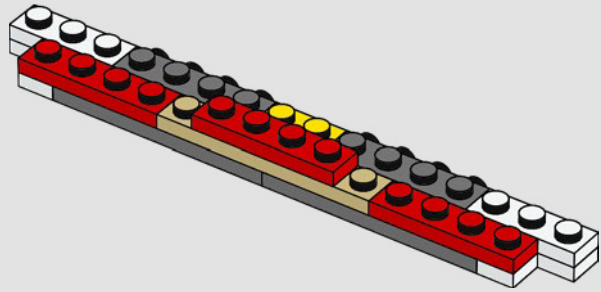

402

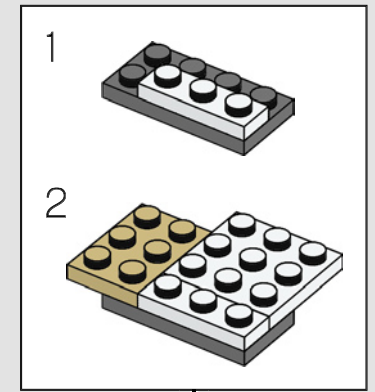
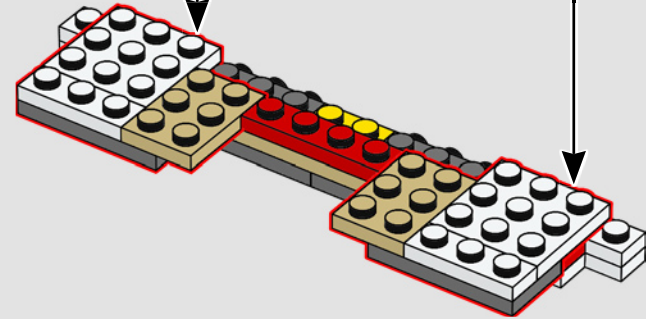
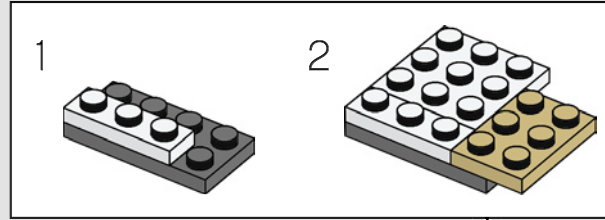

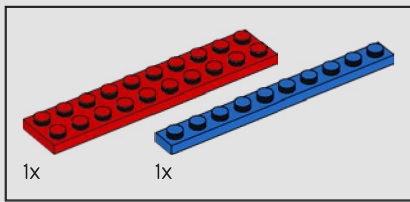

403

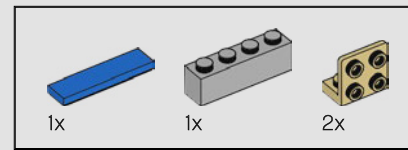
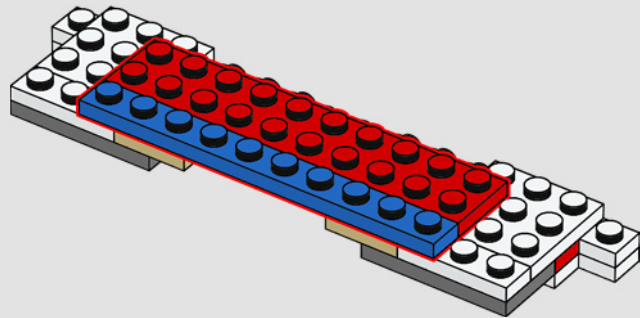

404

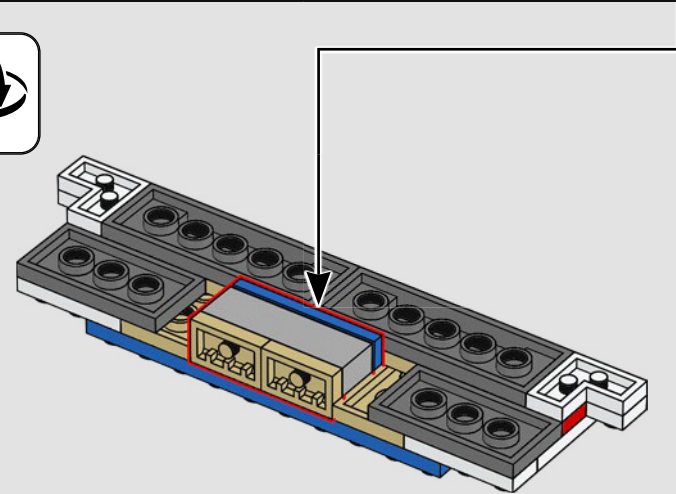
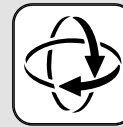
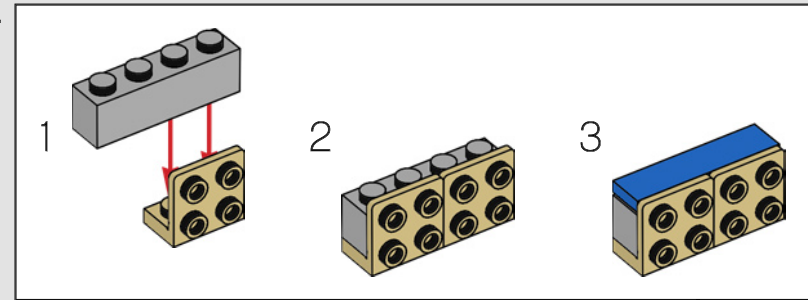

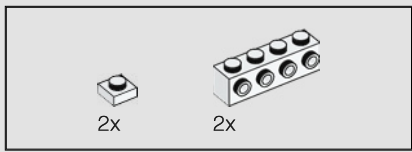

405

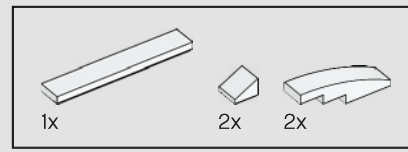
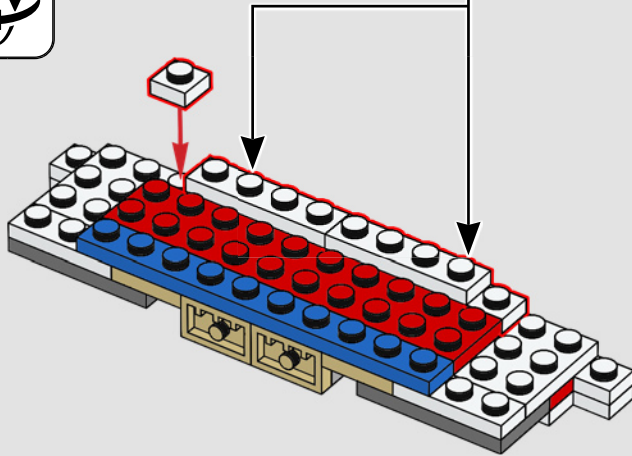
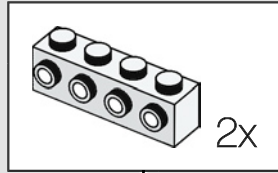

406

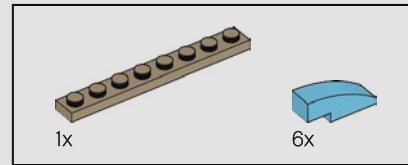
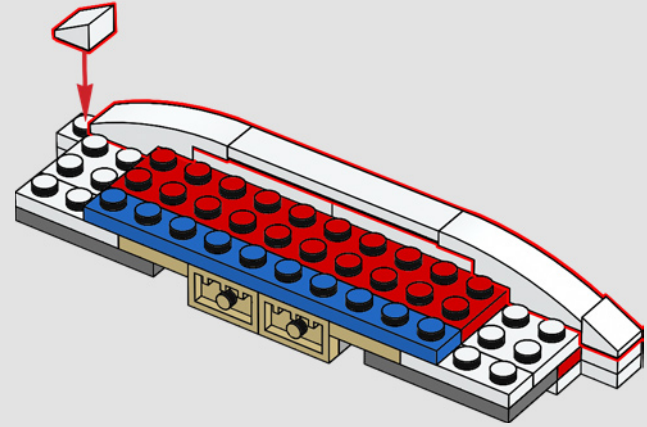

407

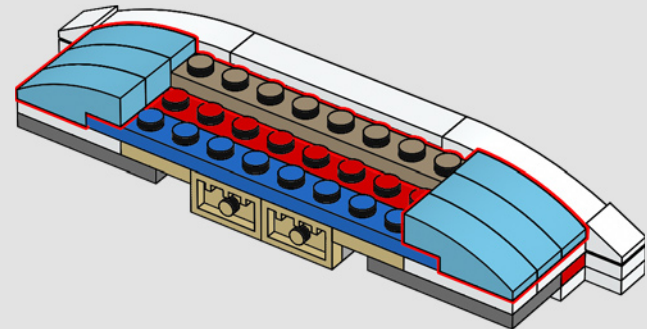

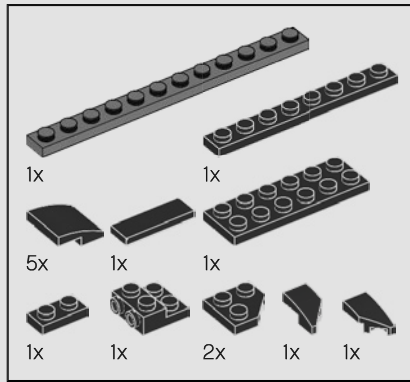
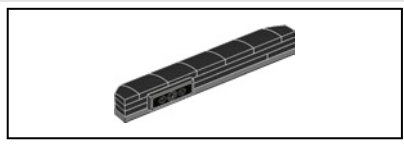

408

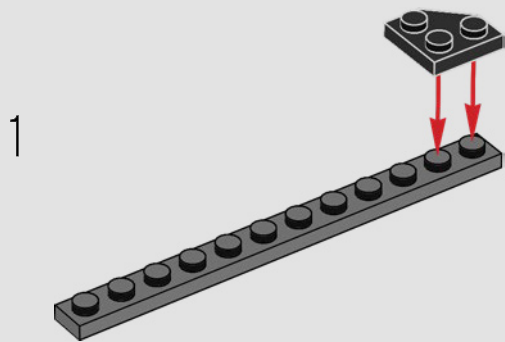

2

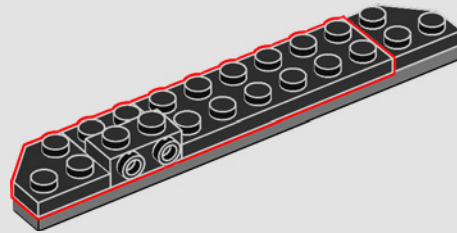

3

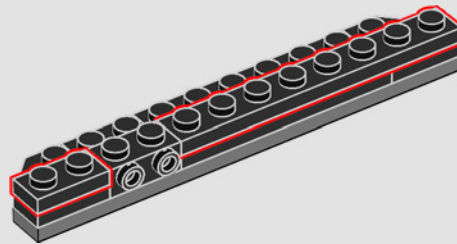

4

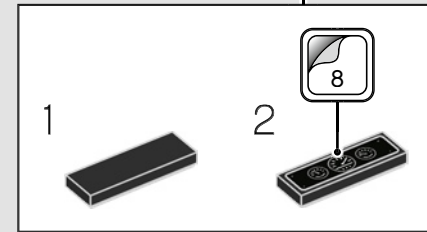
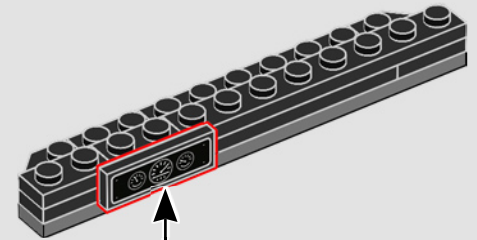

5

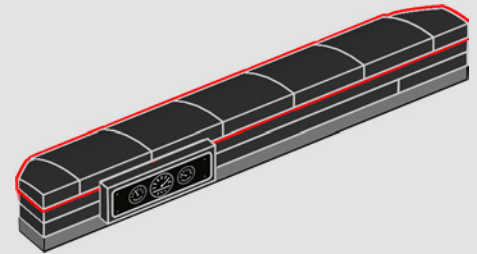

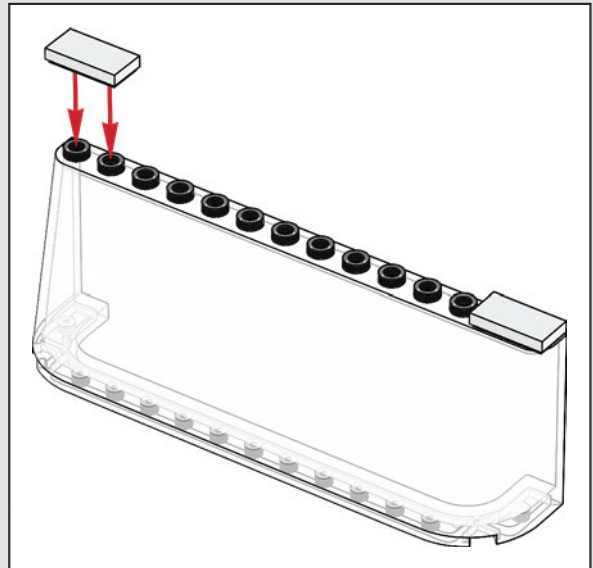
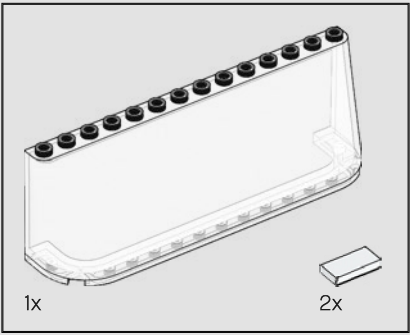

409

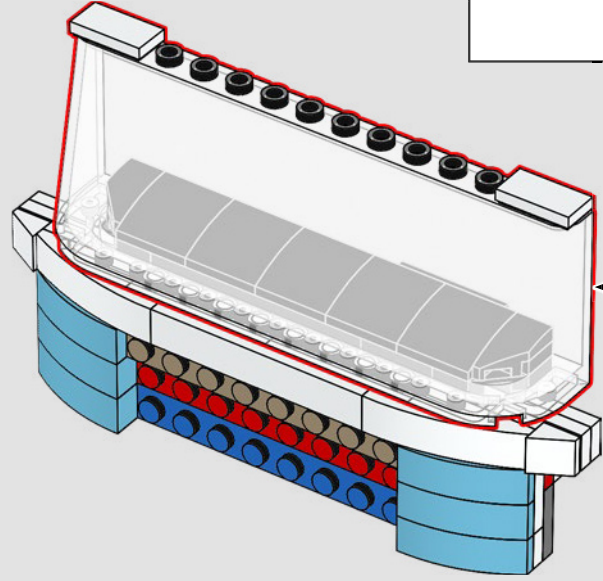
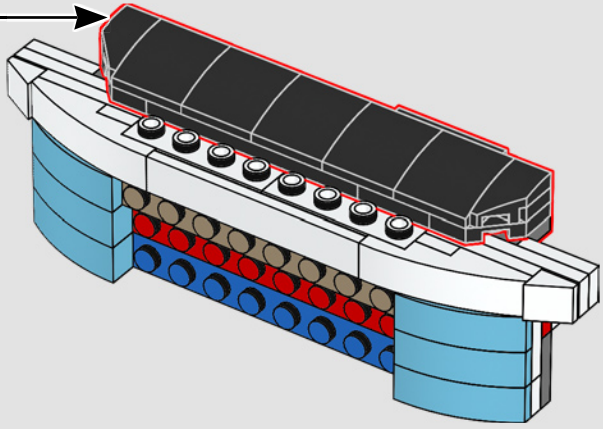

410

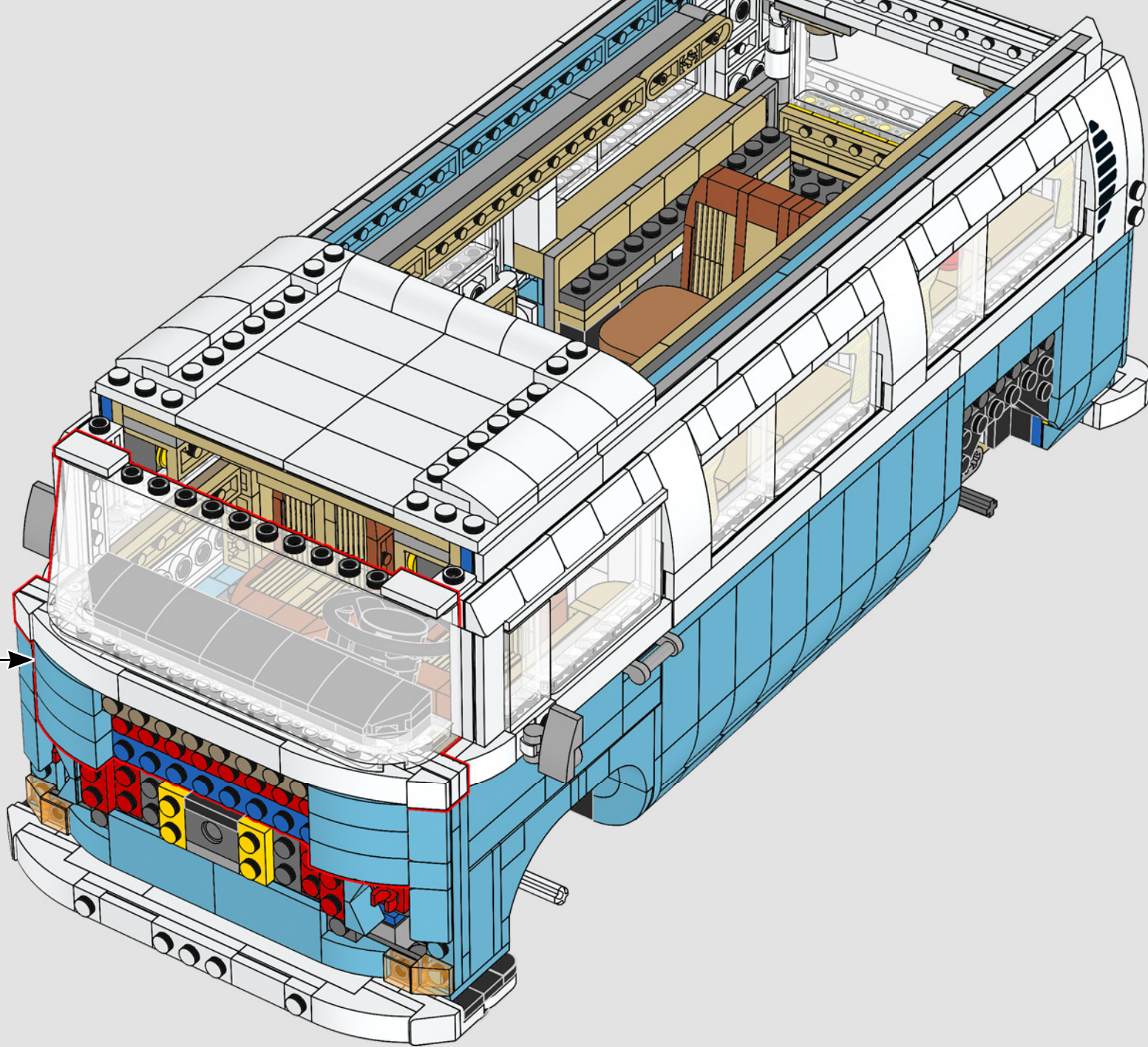

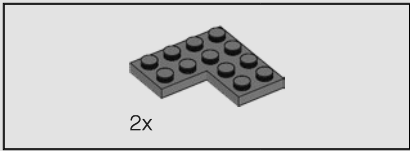

411

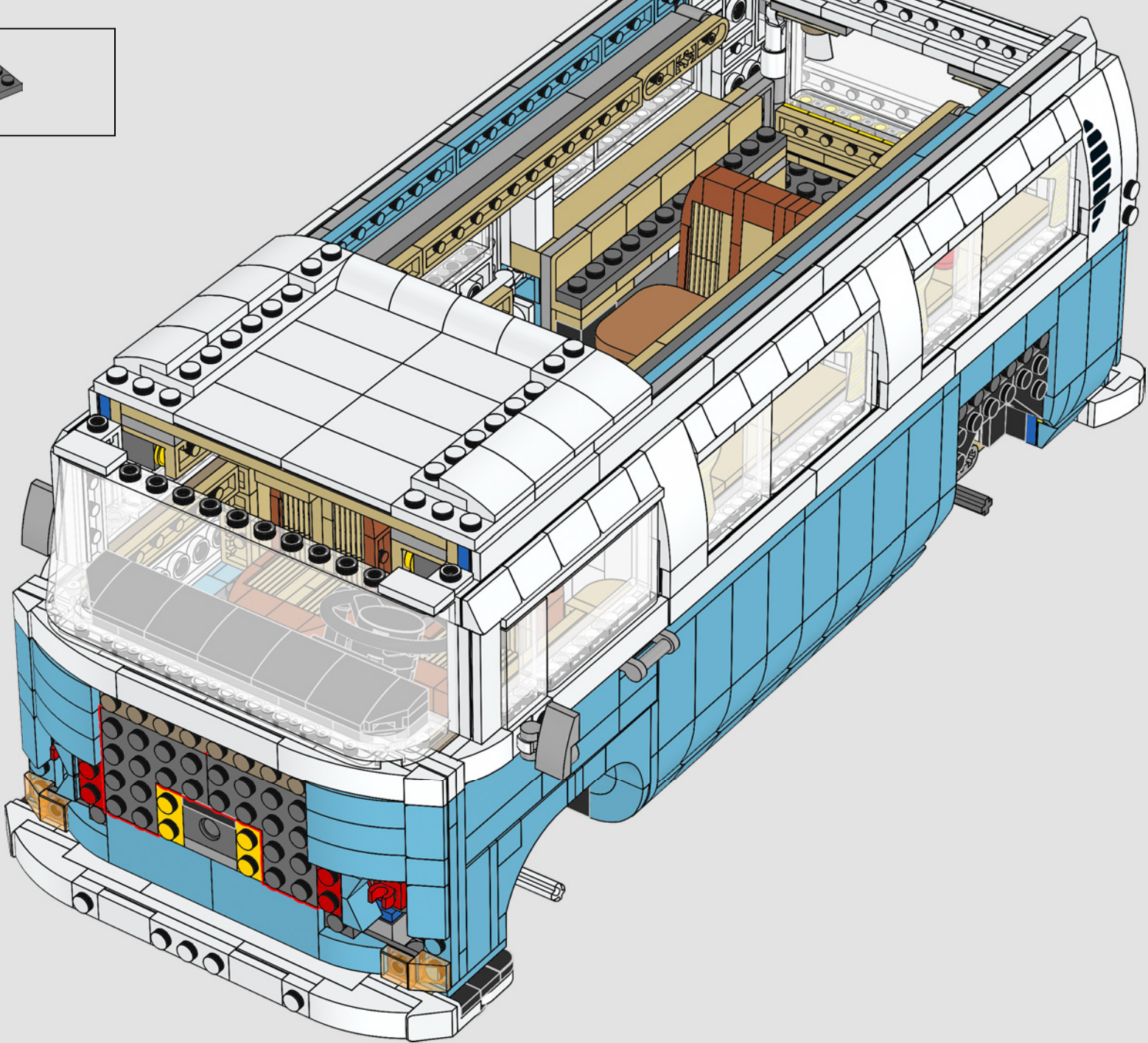

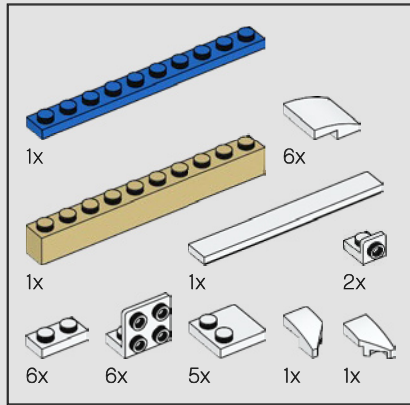
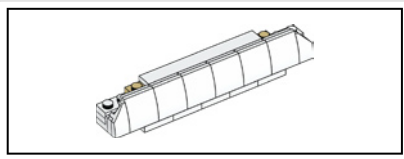

412

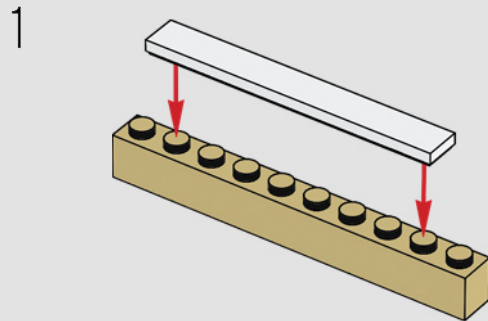

2

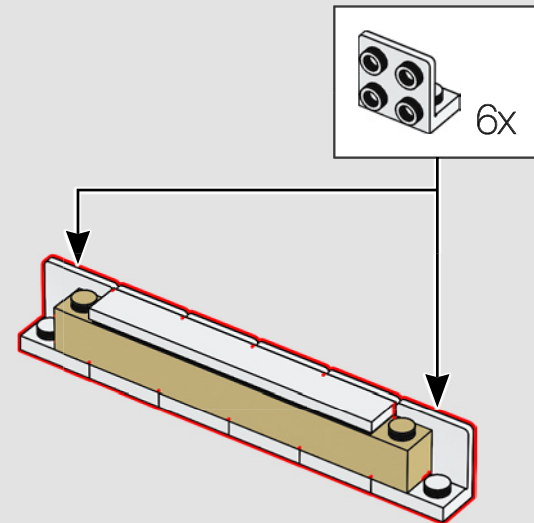

Il VW T2 aveva molti soprannomi in tutto il mondo. In Germania era detto "Bulli".

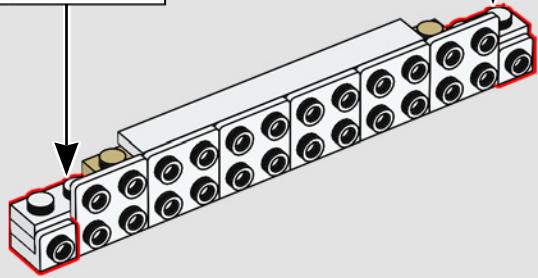
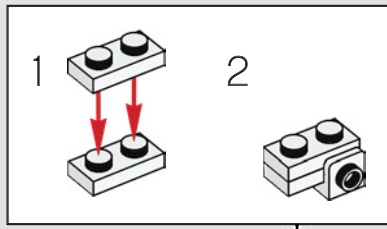
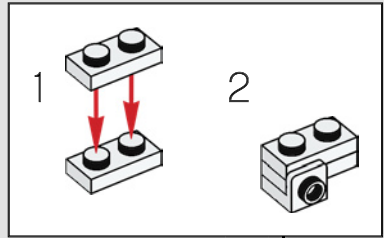

4

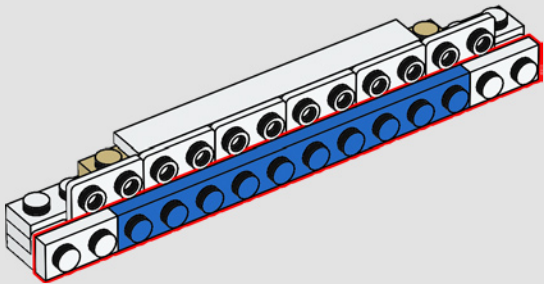

5

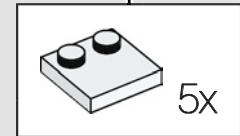
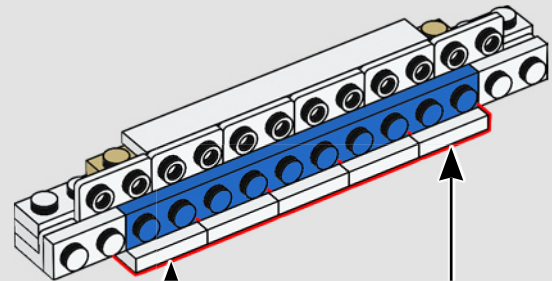

6

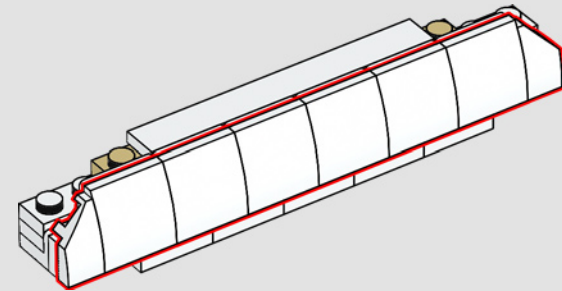

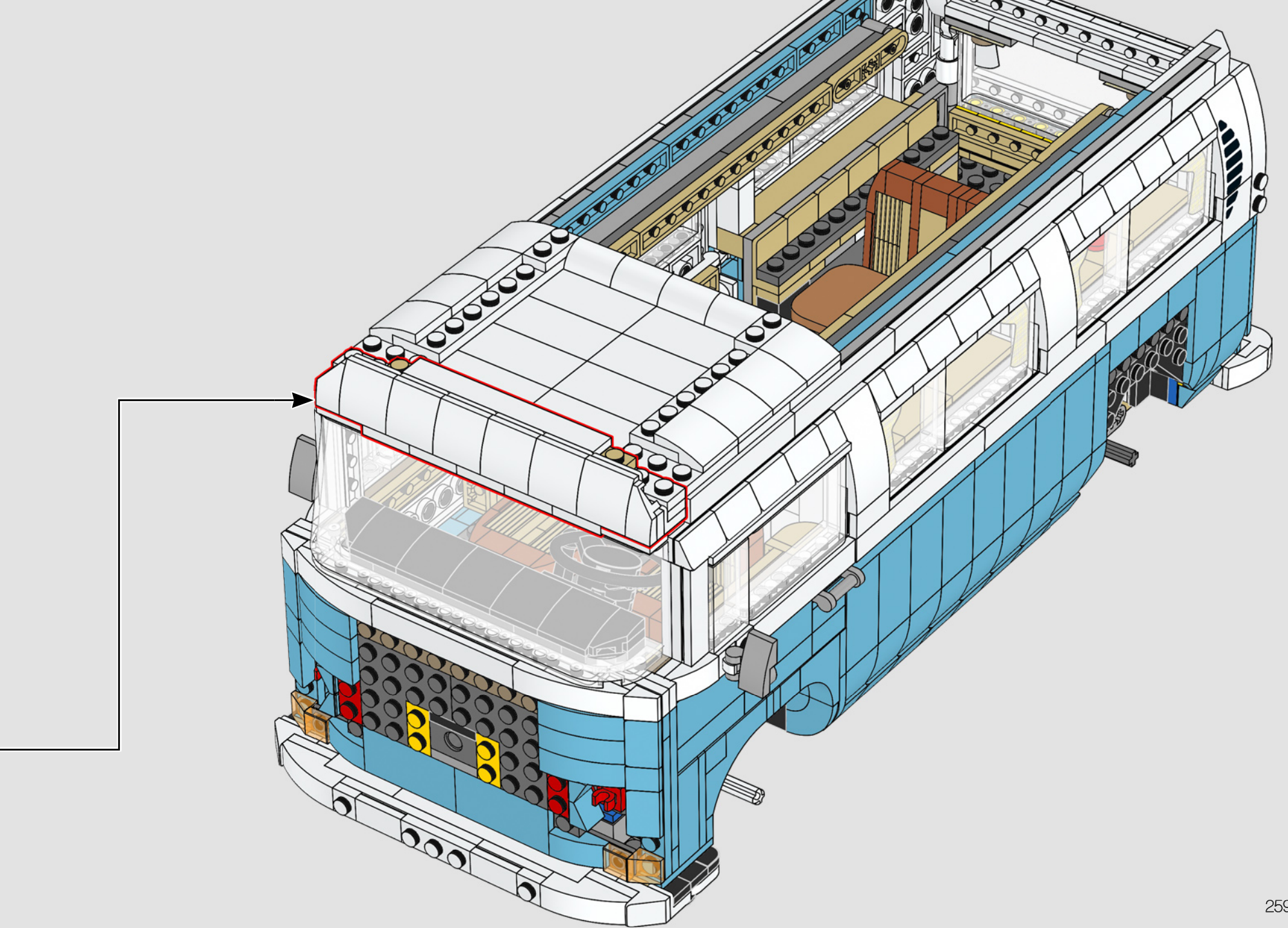

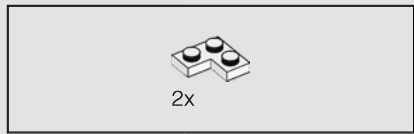

413

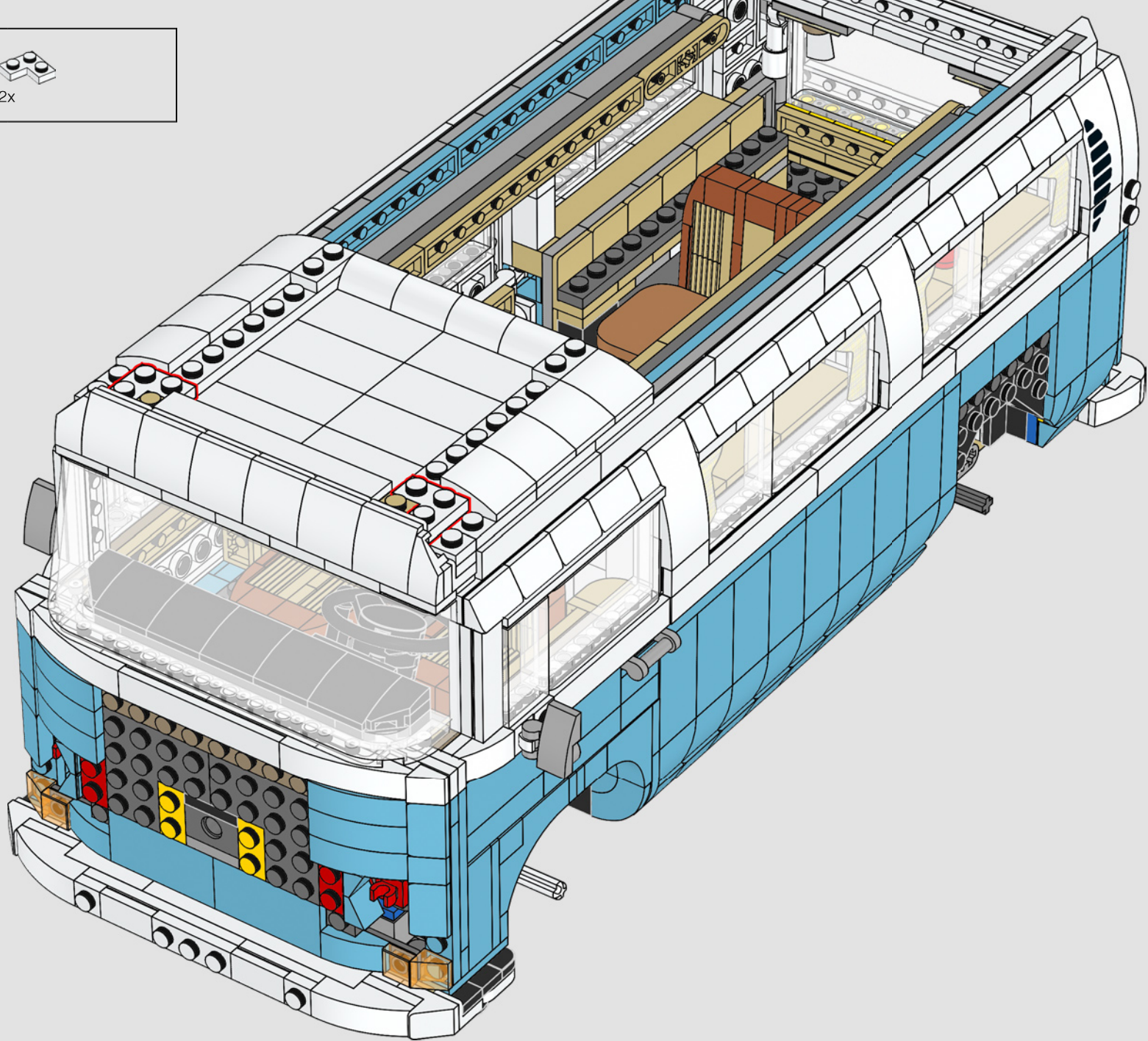

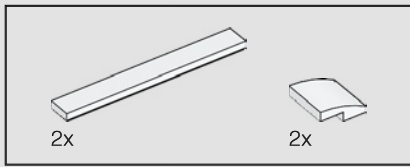

414

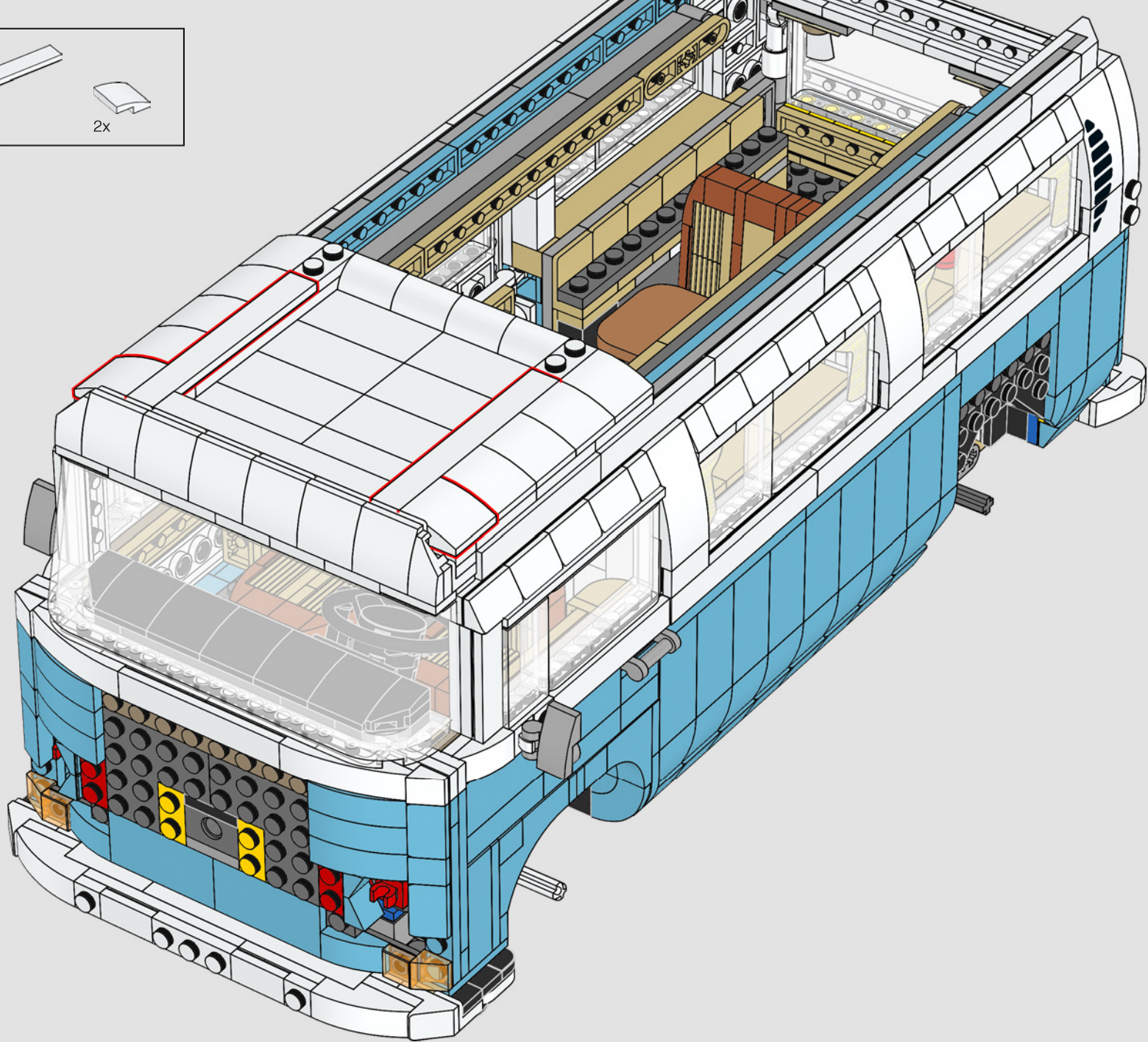

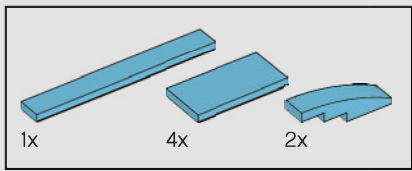

415

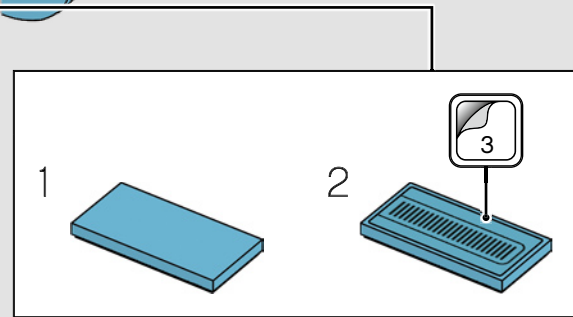
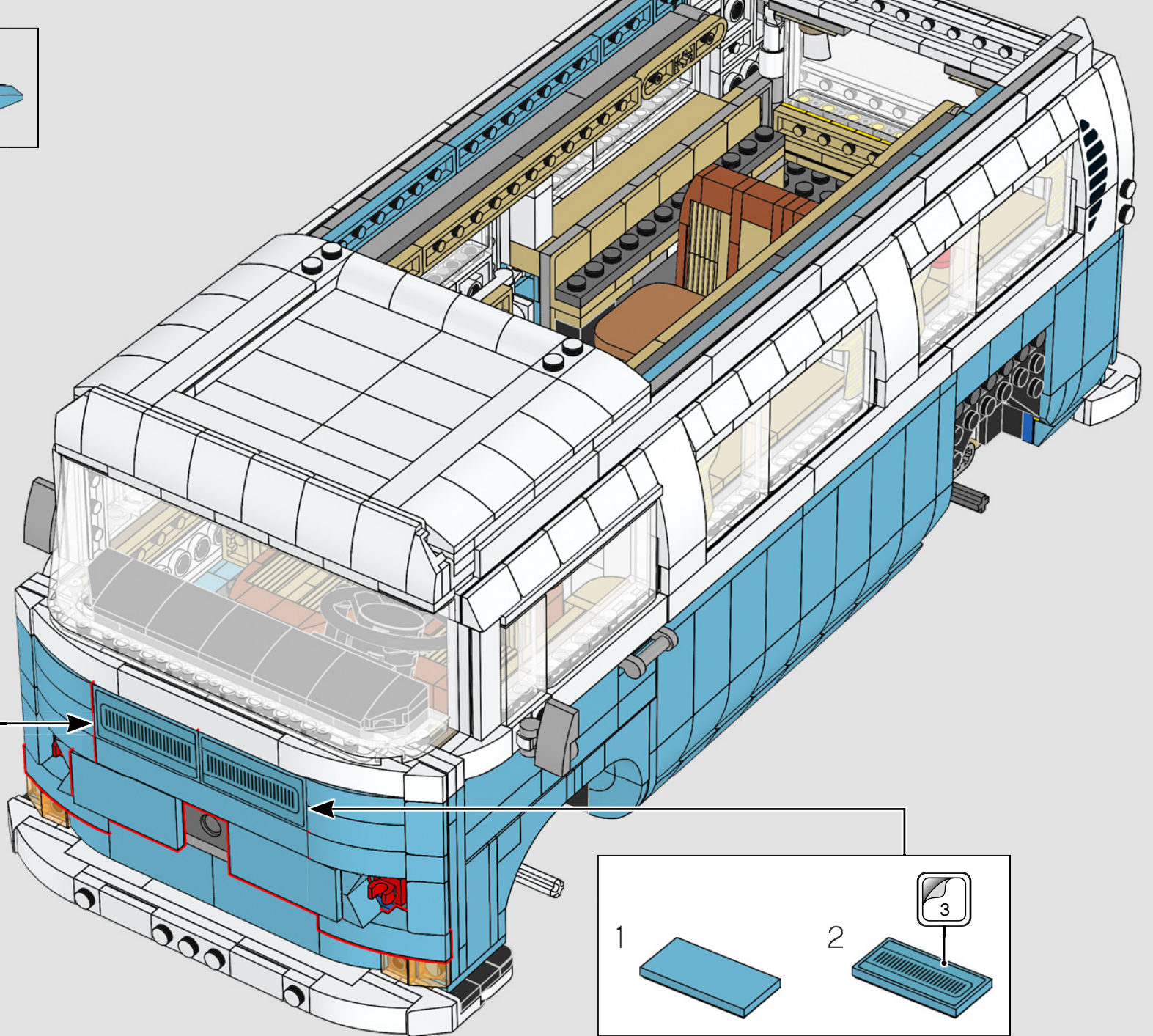
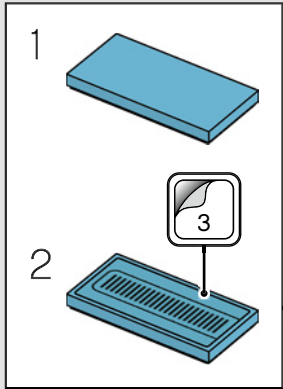

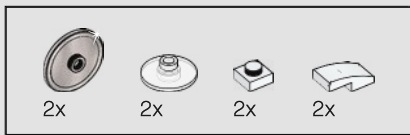

416

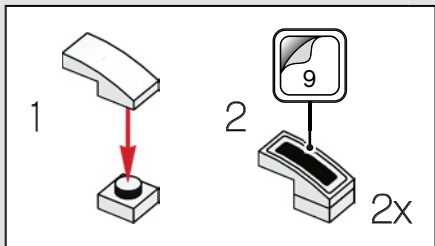
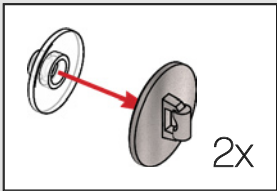
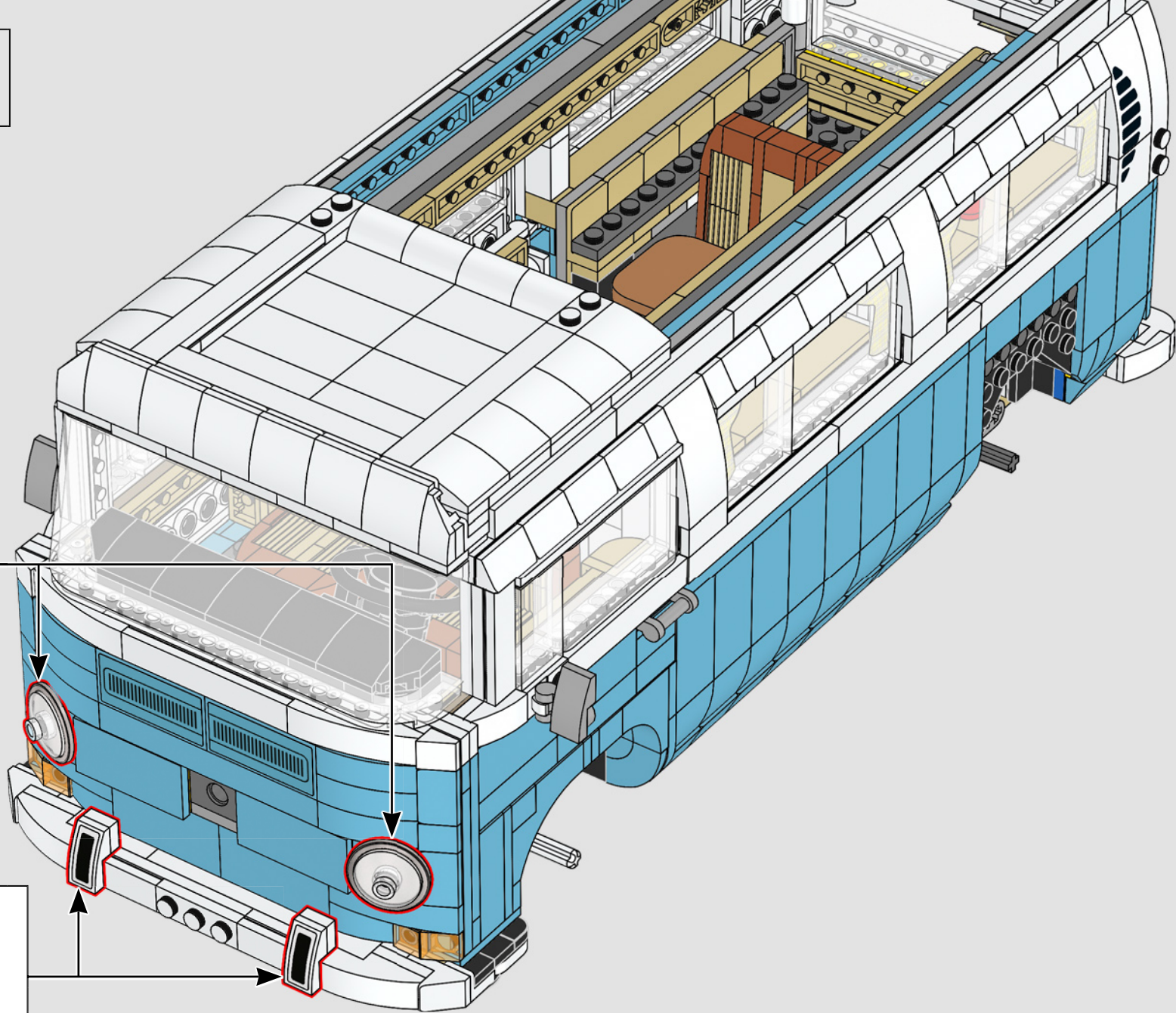

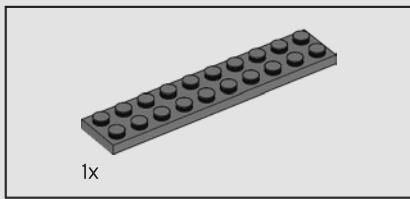

418

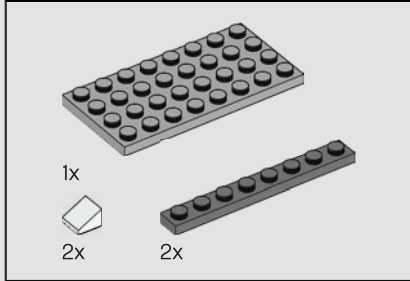
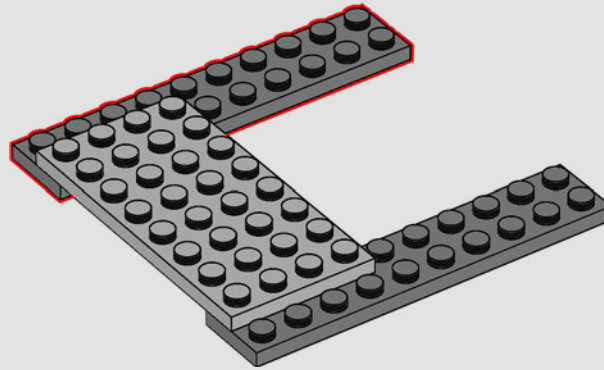

419

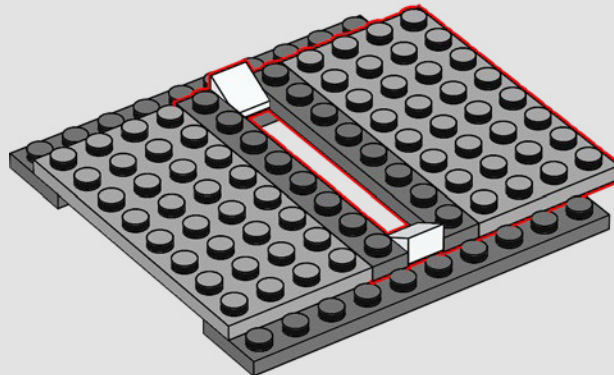

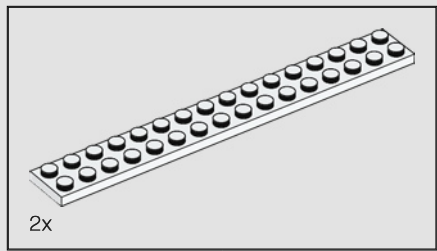

420

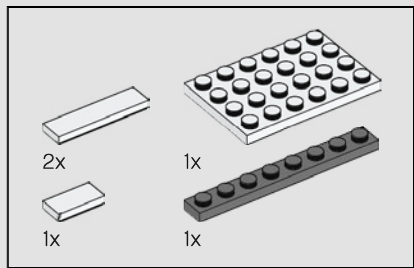
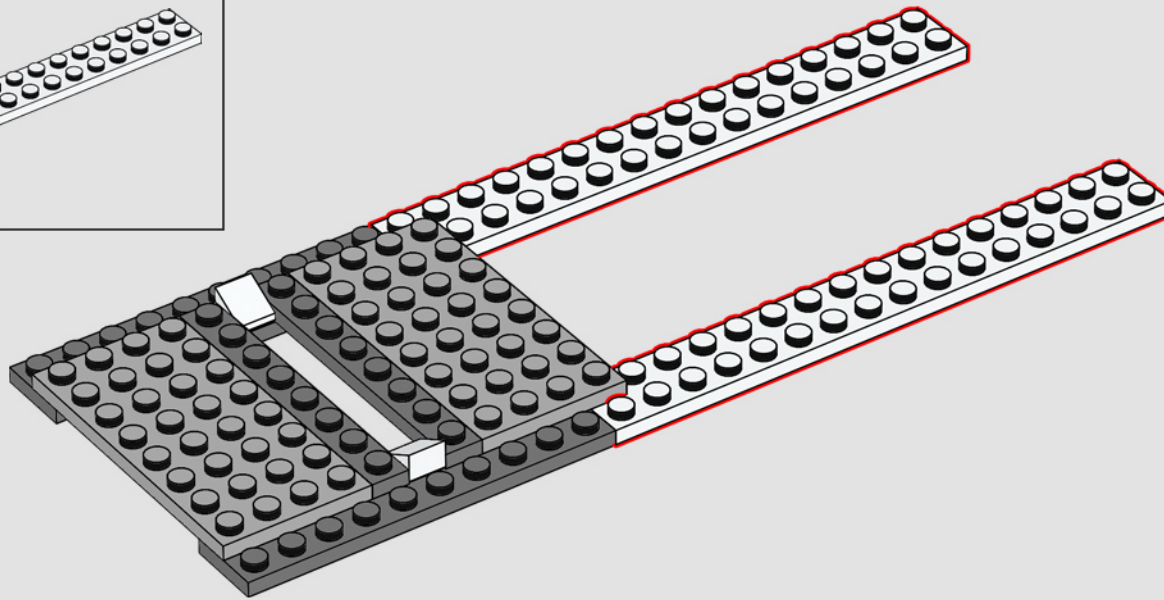

421

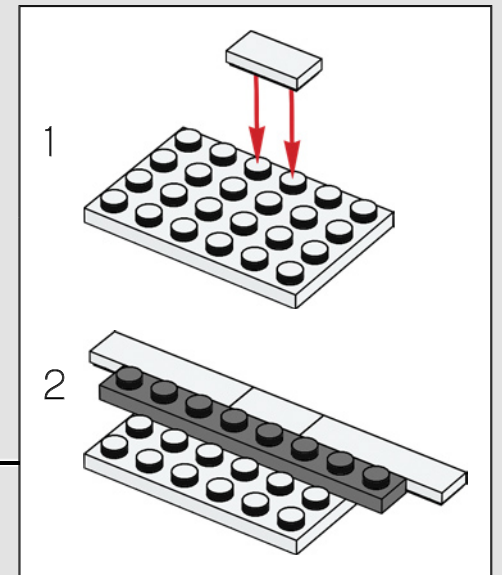
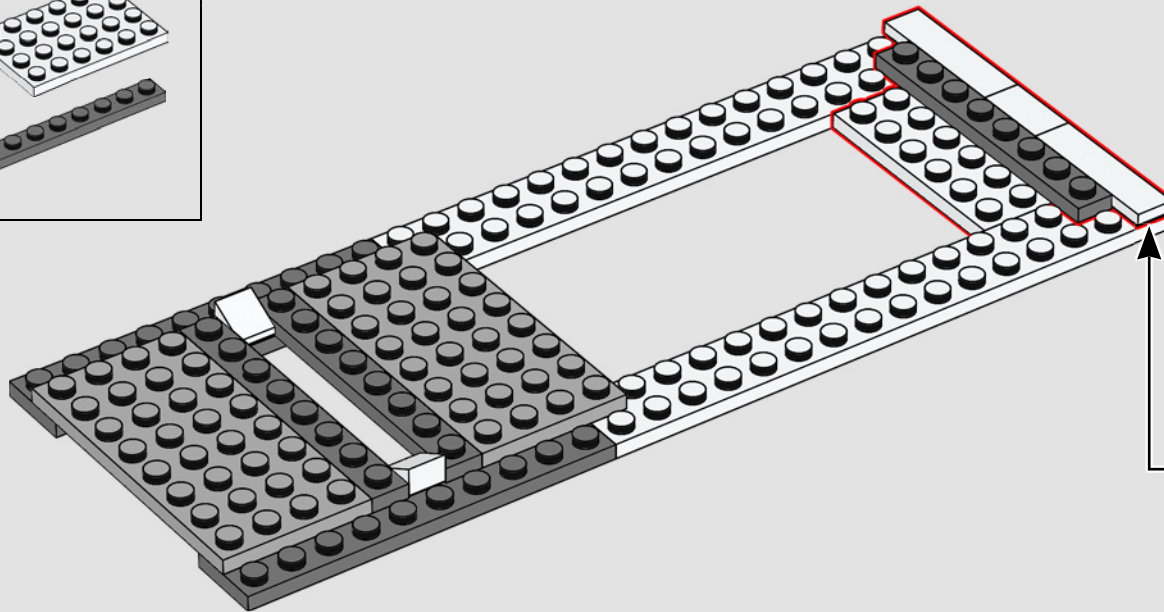

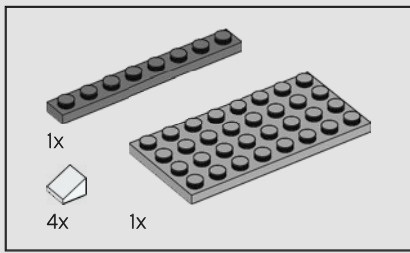

422

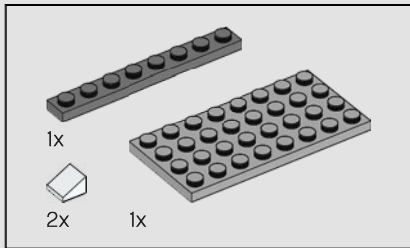
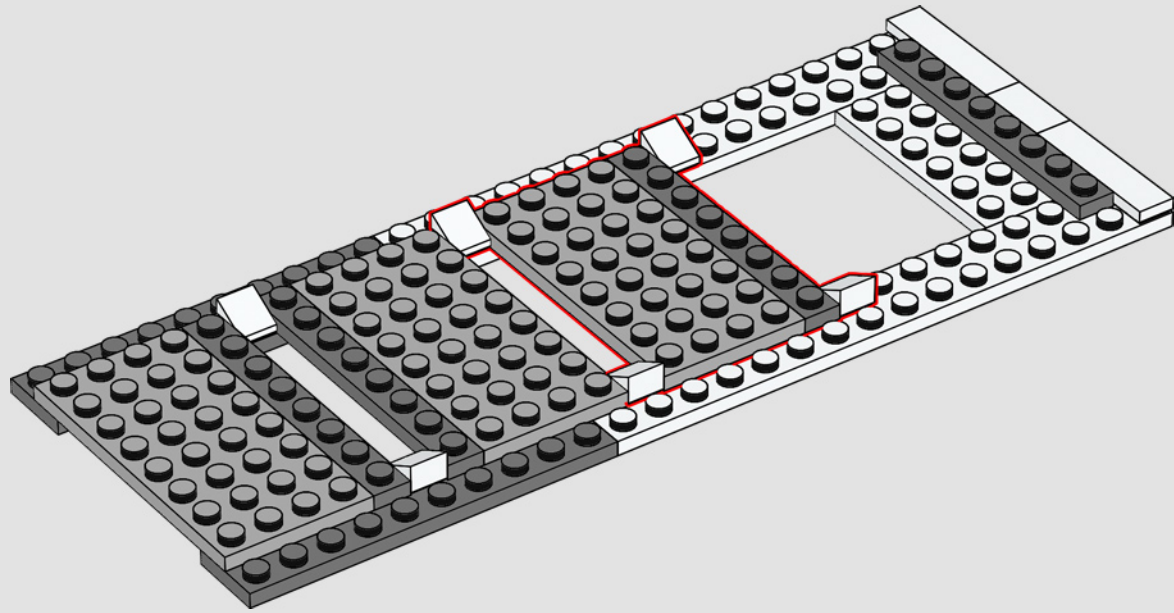

423

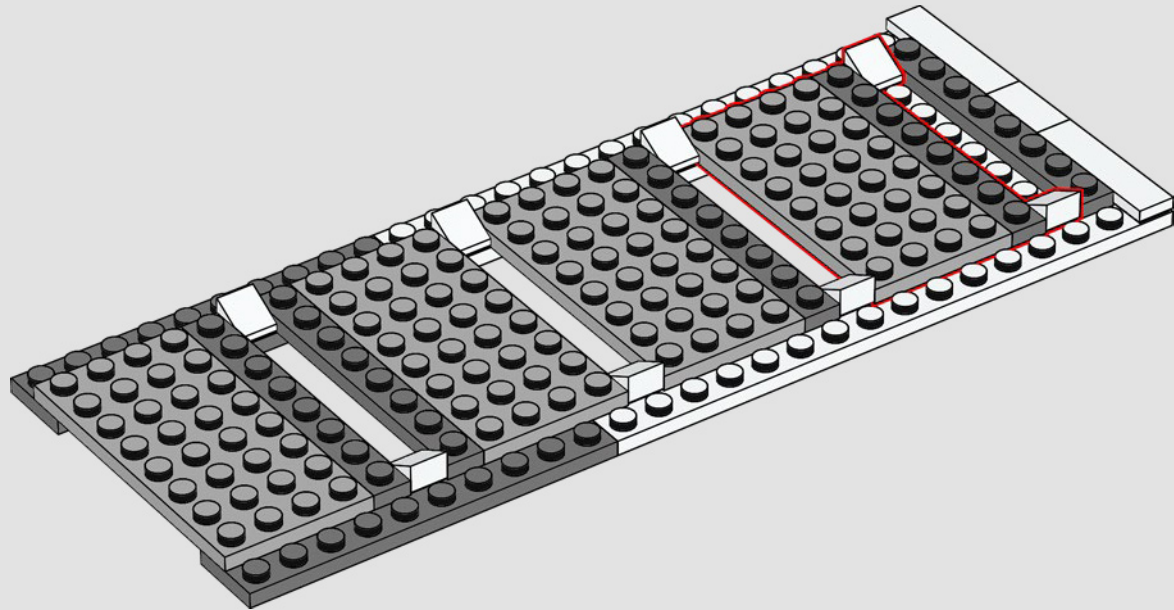

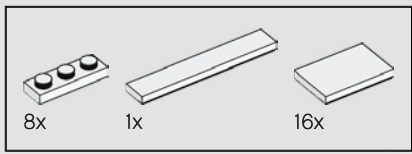

424

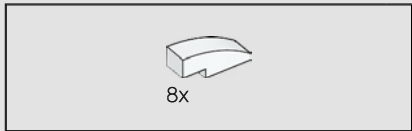
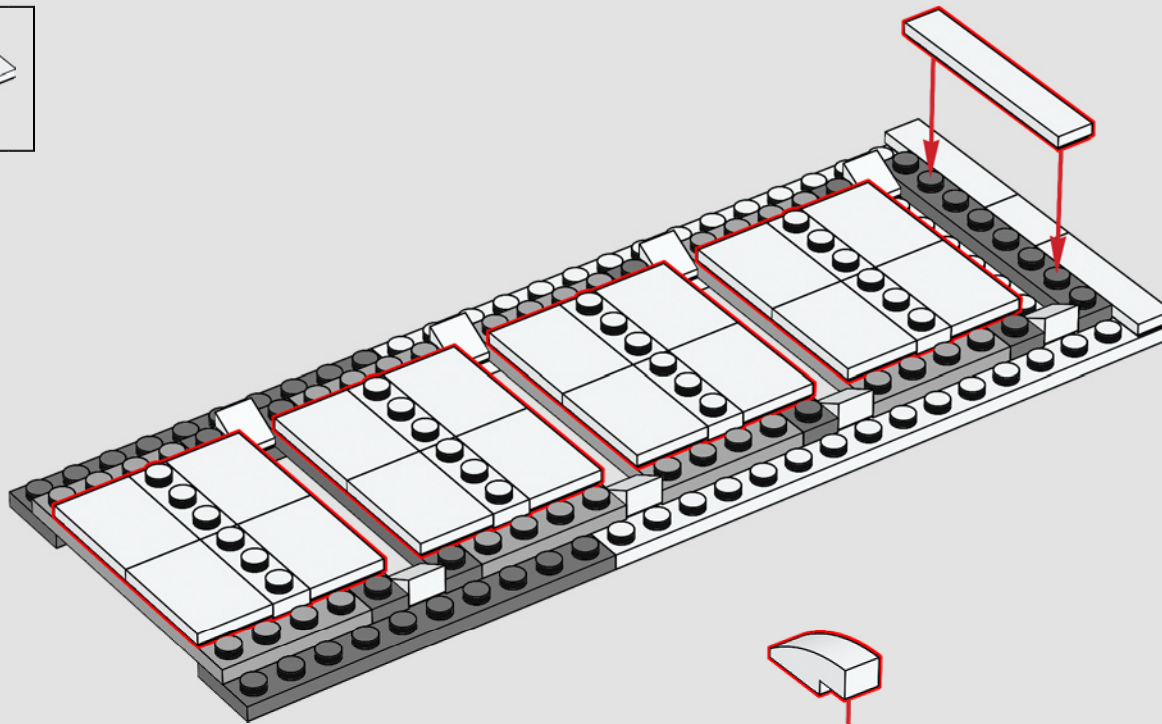

425

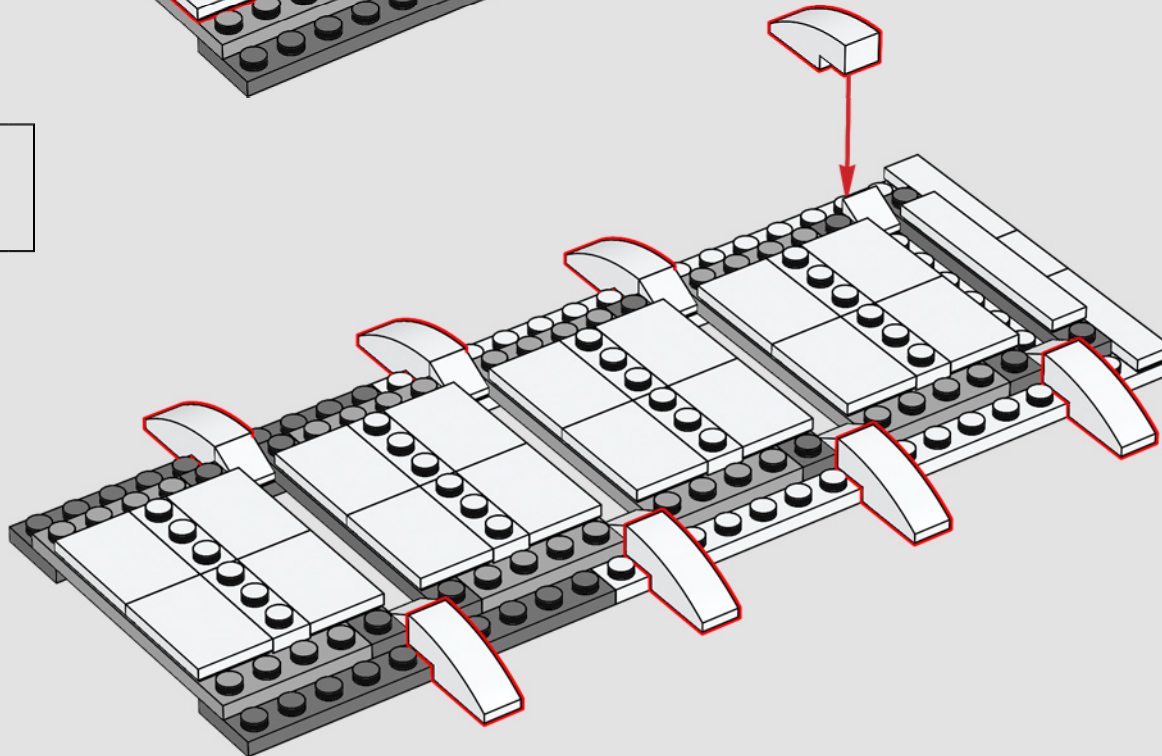

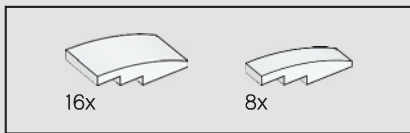

426

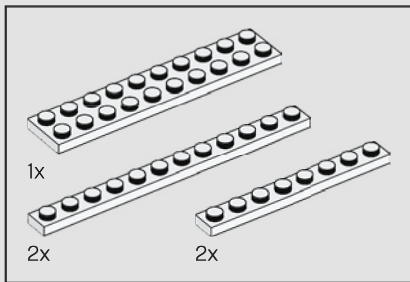
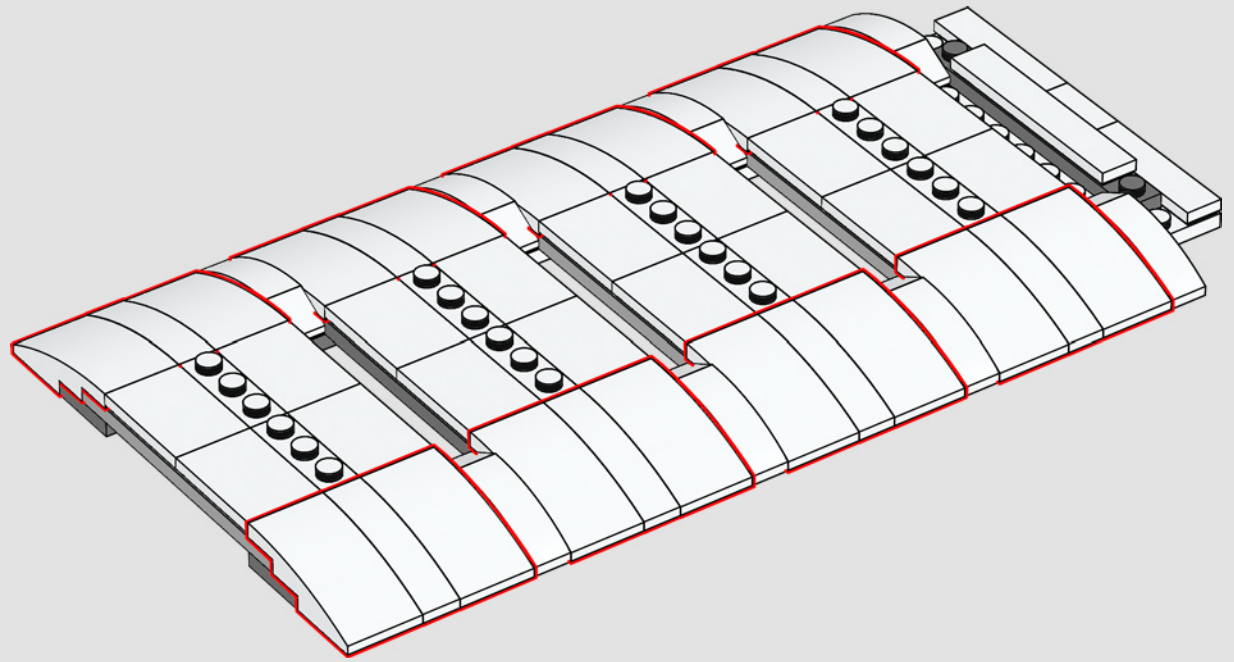

427

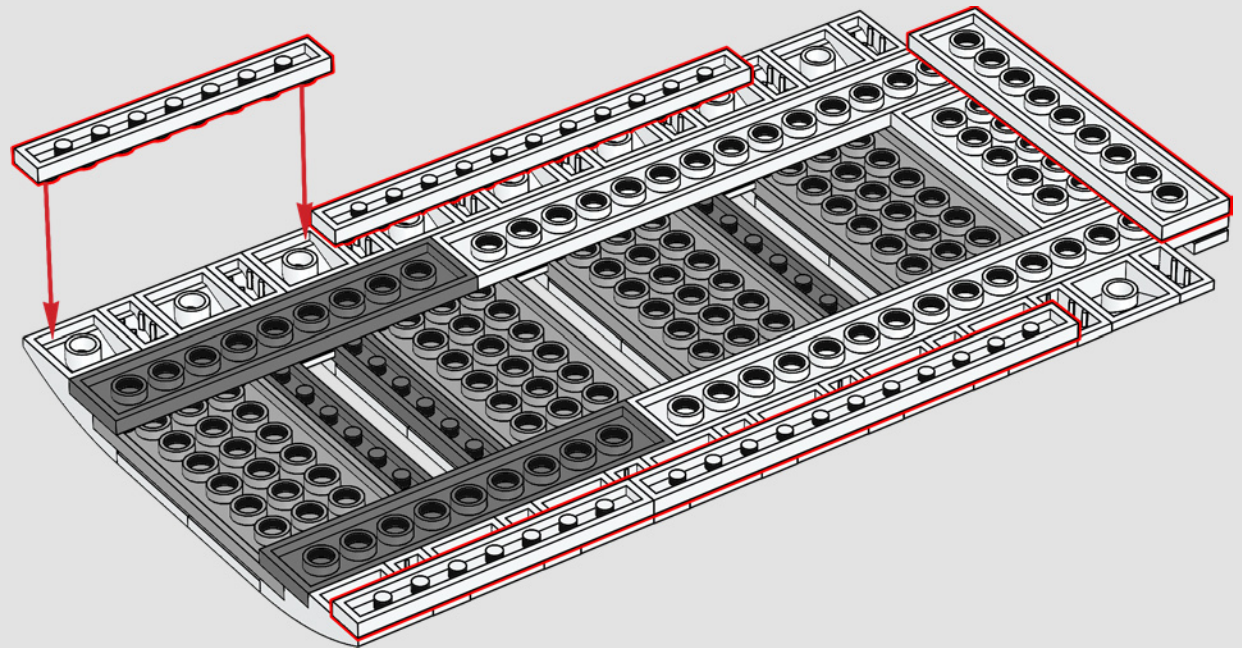

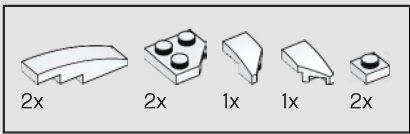

428

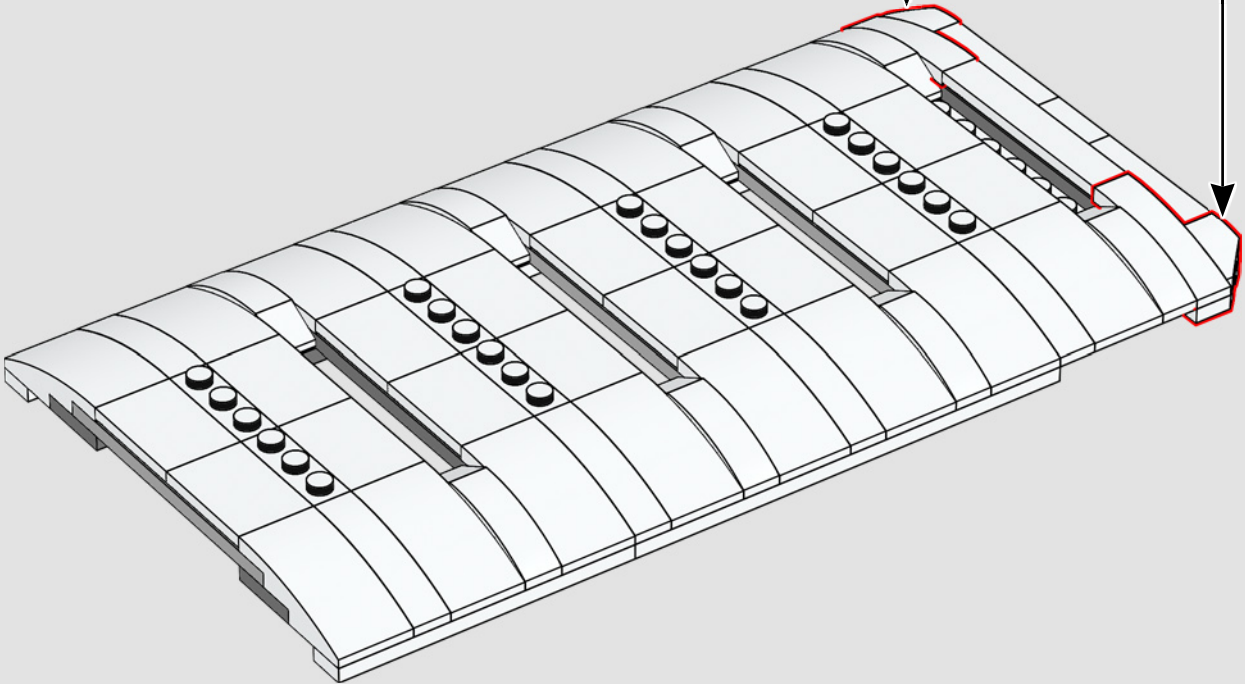
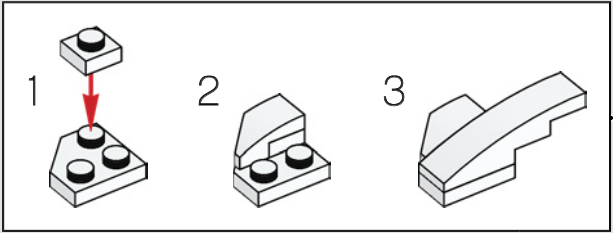
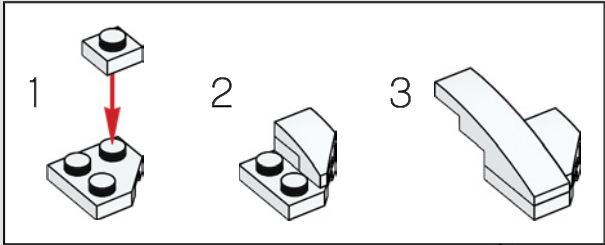

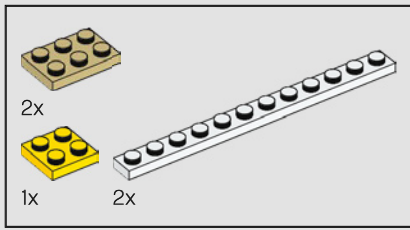

429

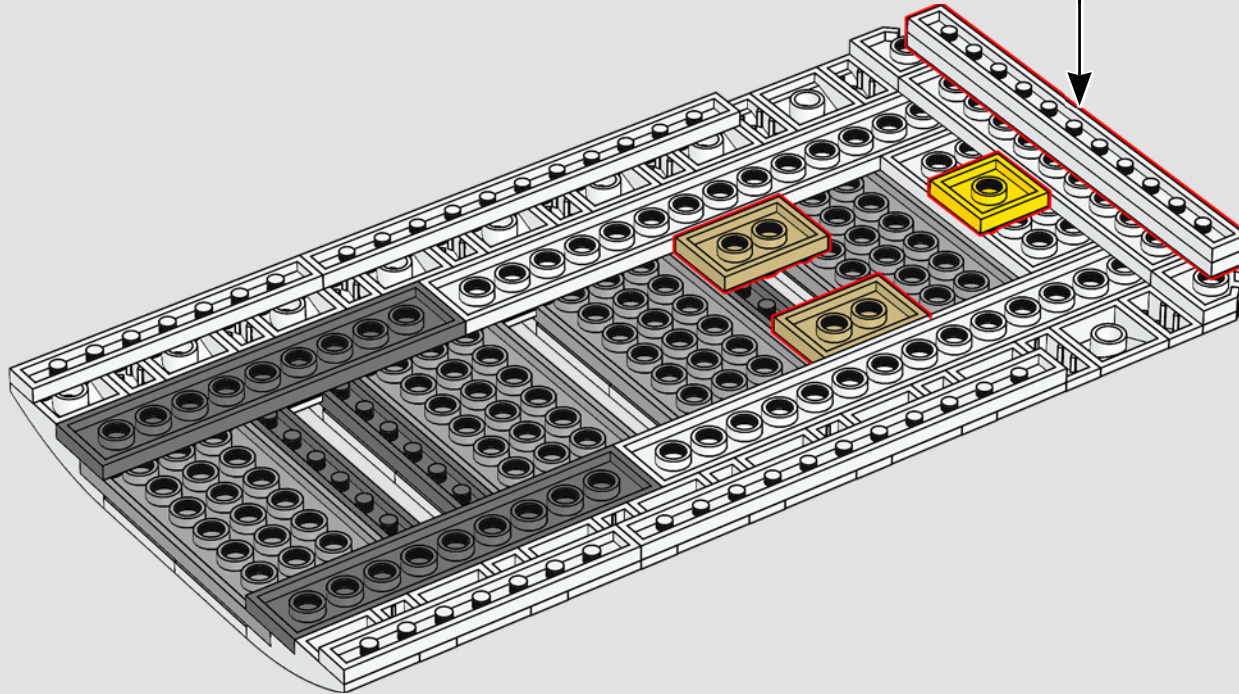
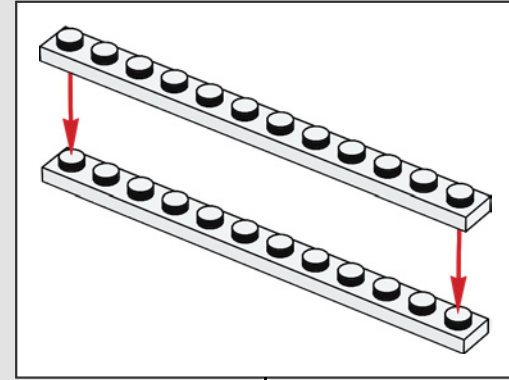

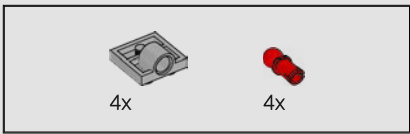

430

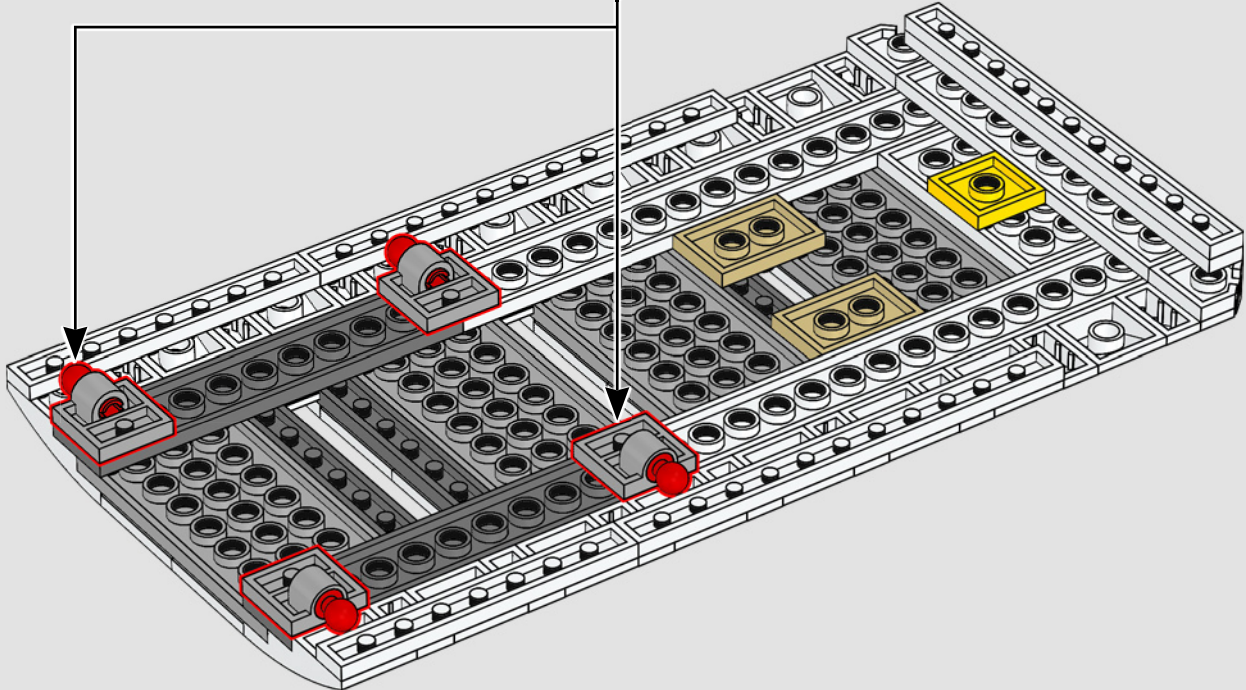
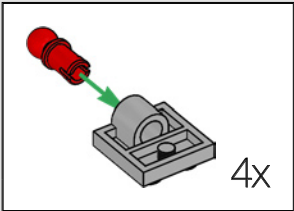

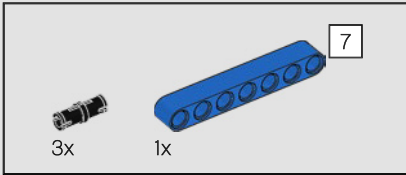
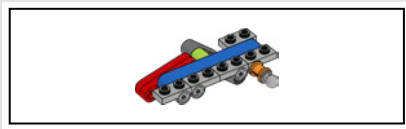

431

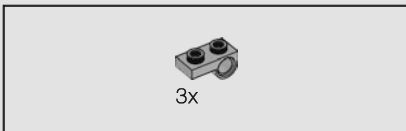
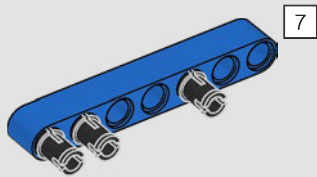

432

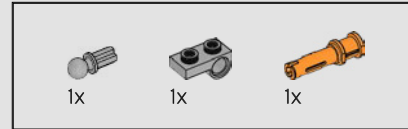
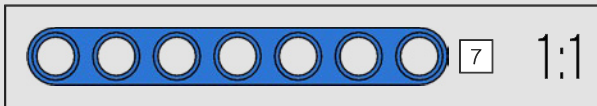
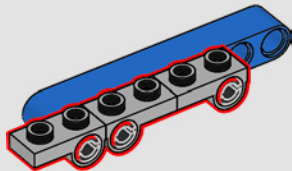

433

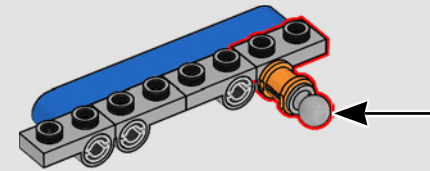
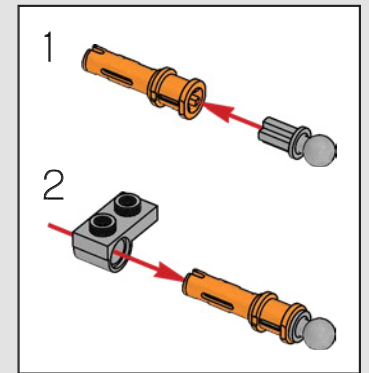

434

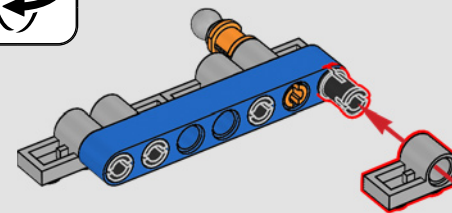
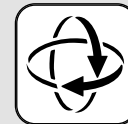



435

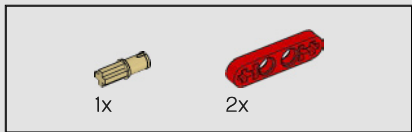
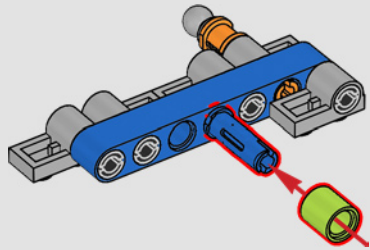

436

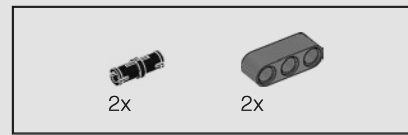
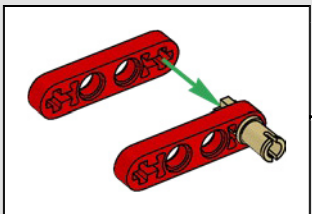
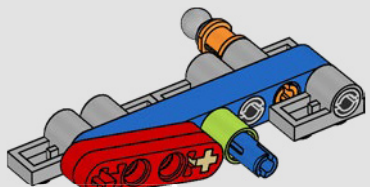

437

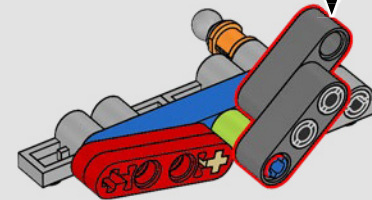
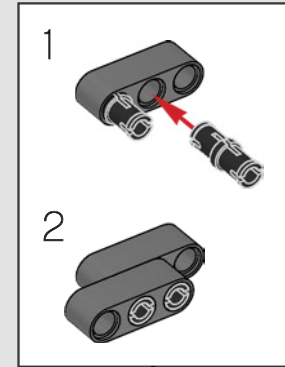

438

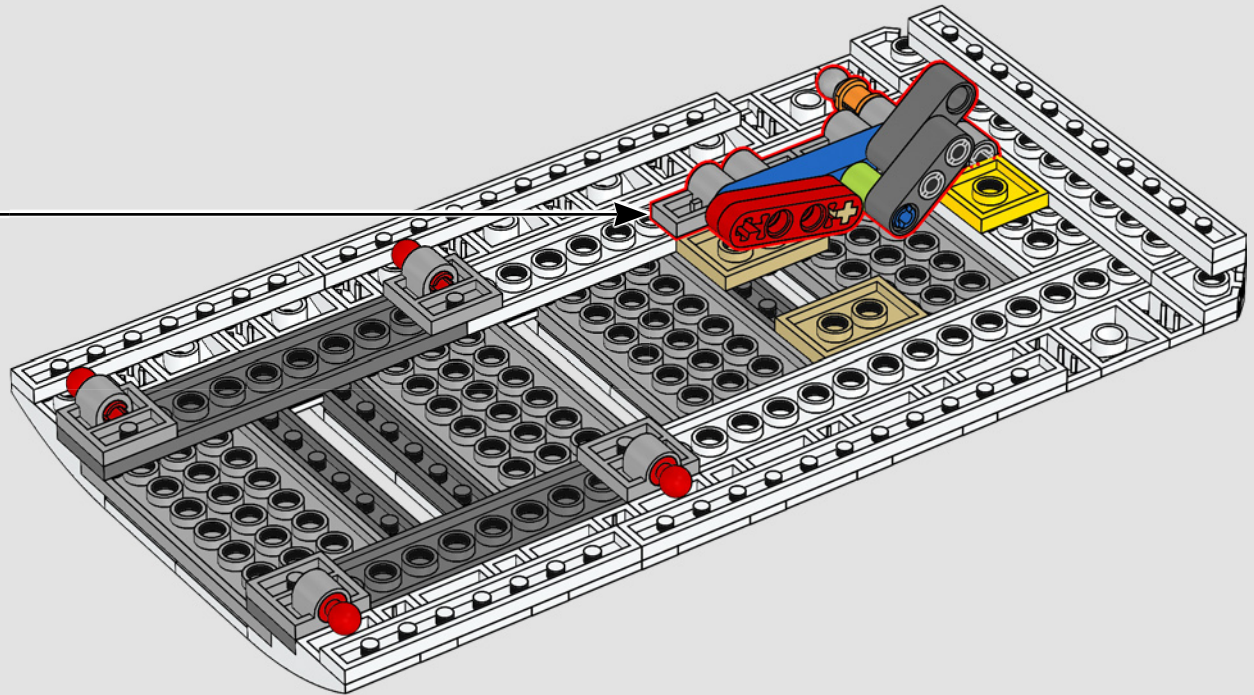

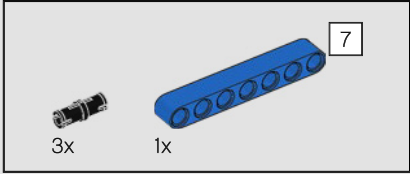
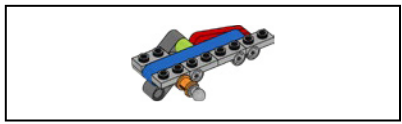

439

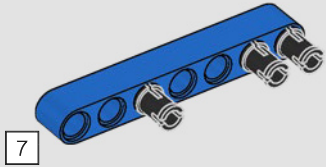

440

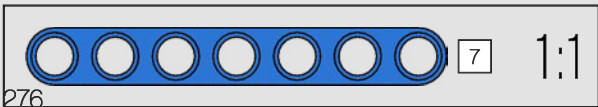
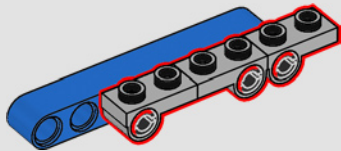

276

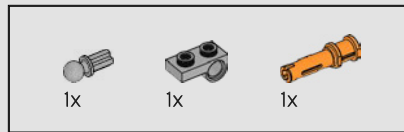

441

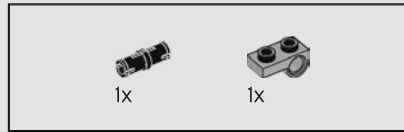
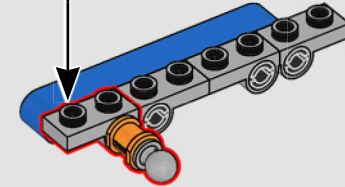
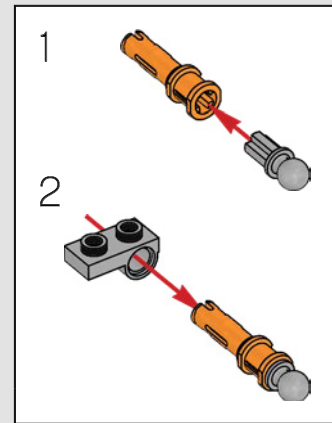

442

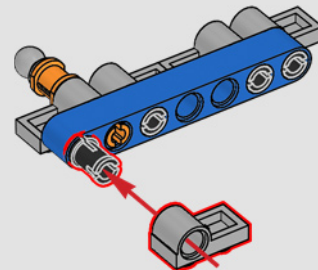
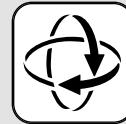

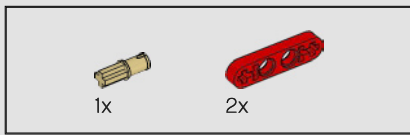

443

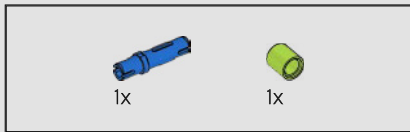
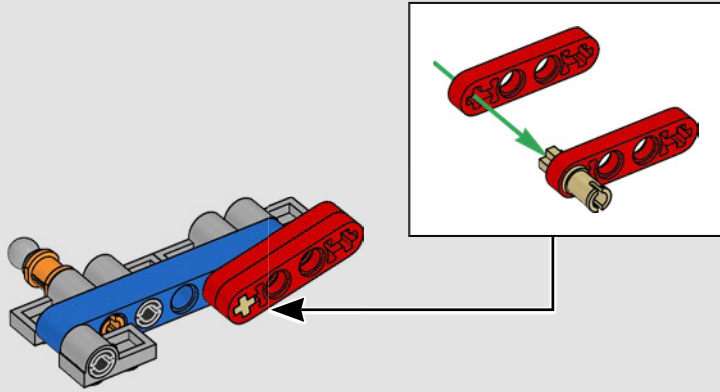

444

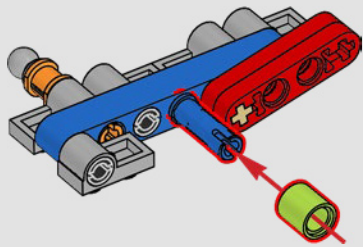

445

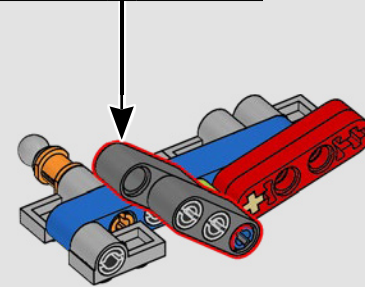
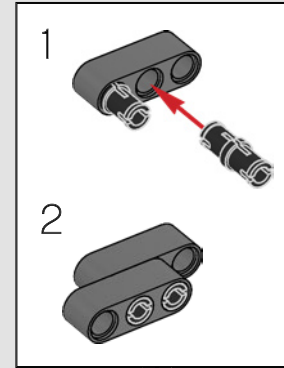

446

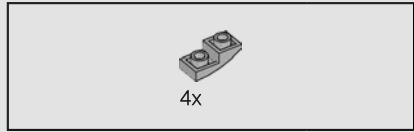
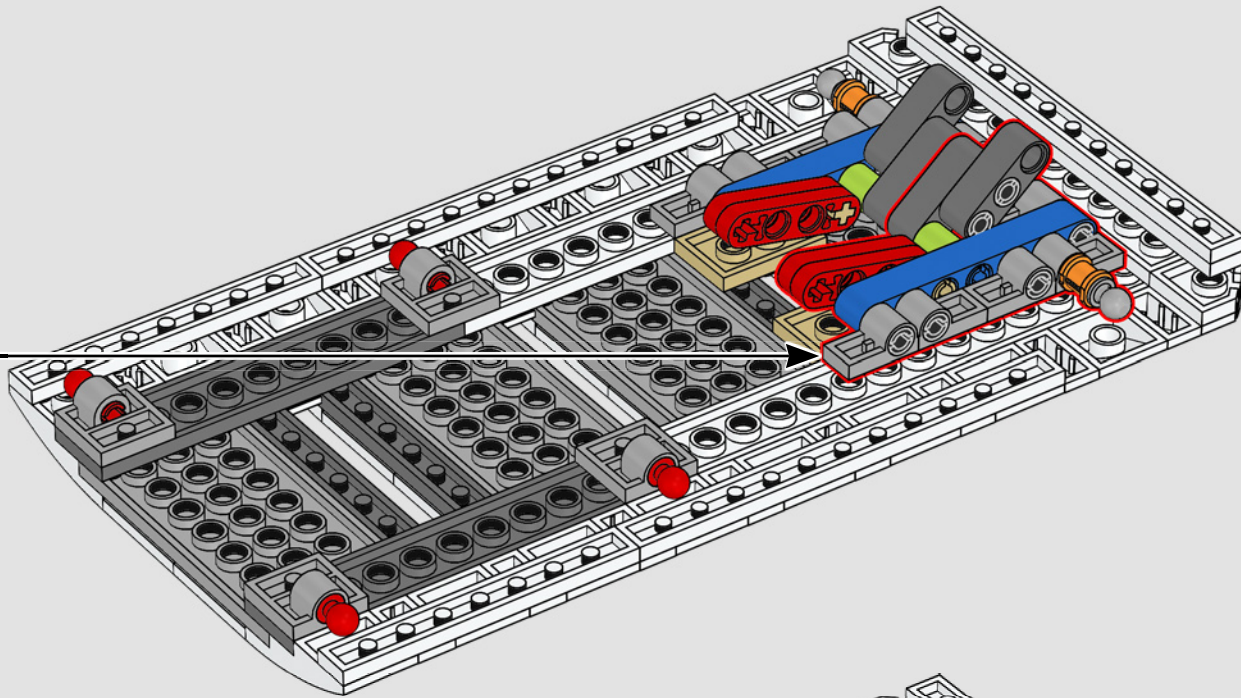

447

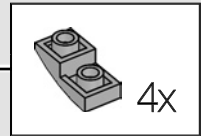
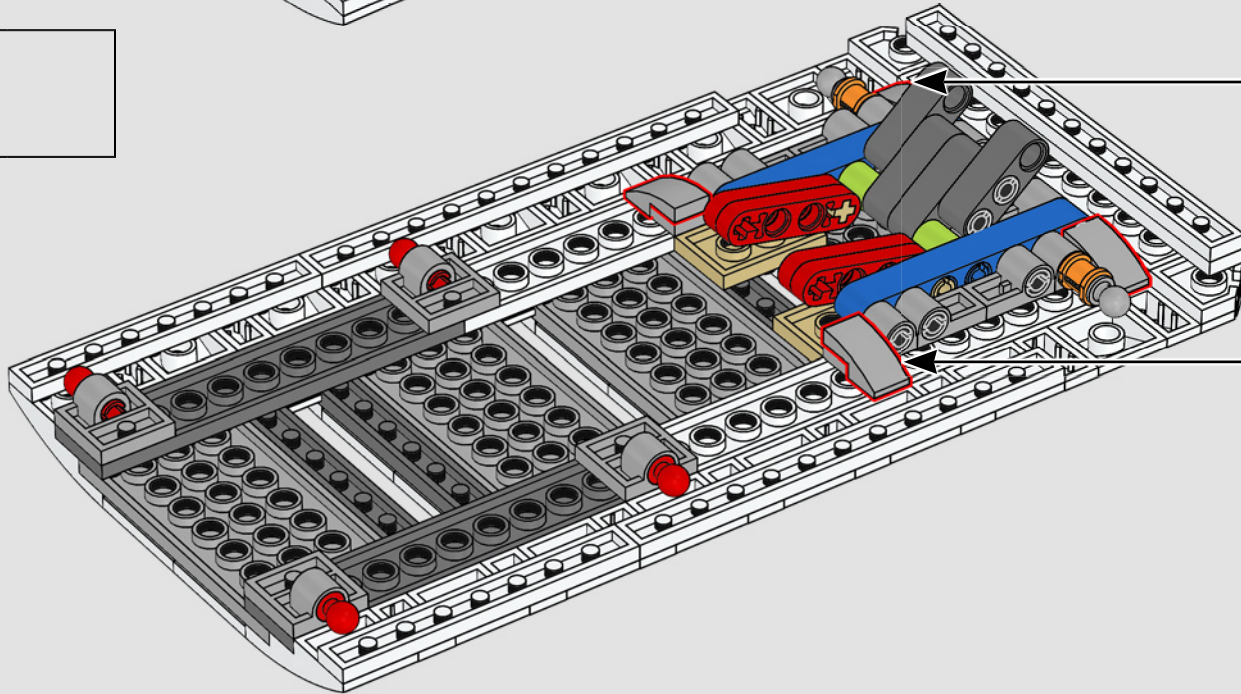

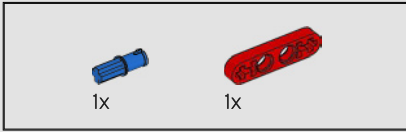
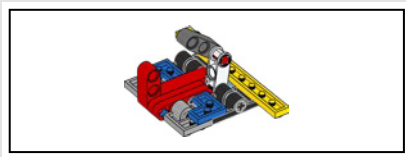

448

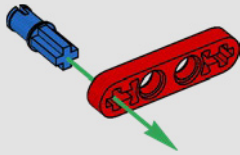

449

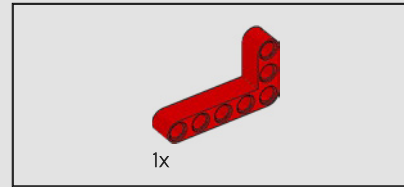
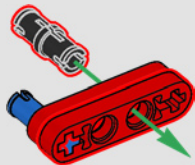

450

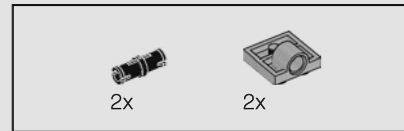
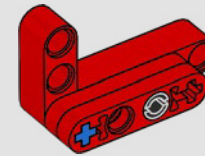

451

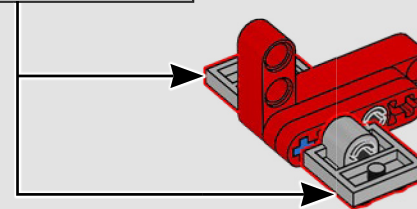
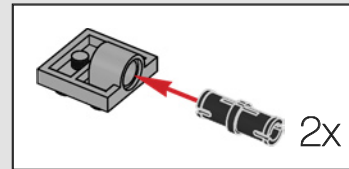

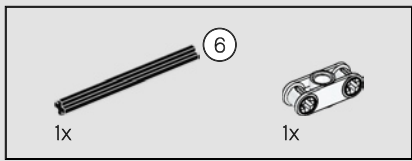

452

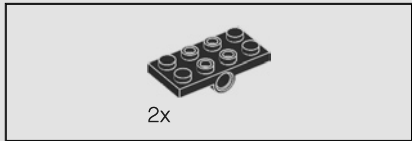
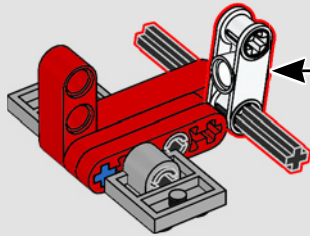
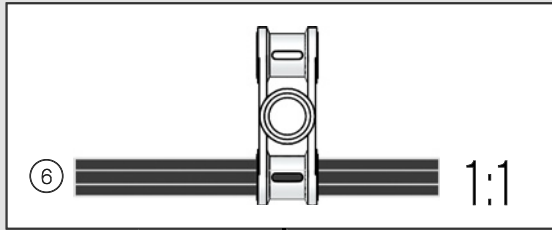

453

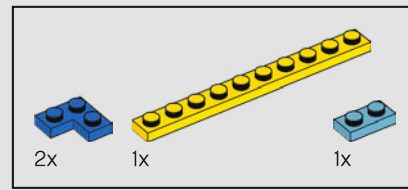
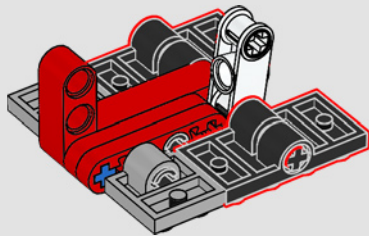

454

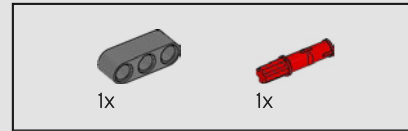
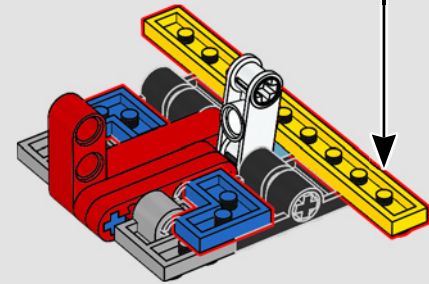
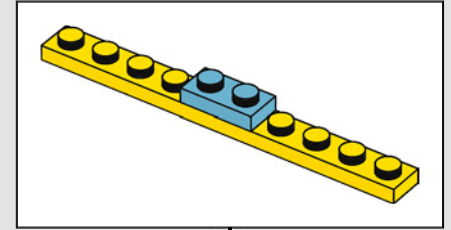

455

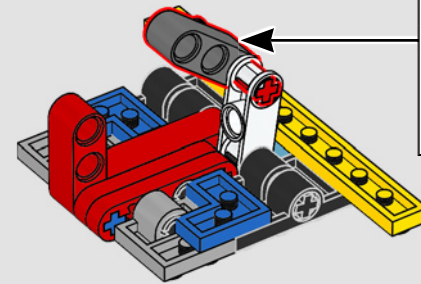
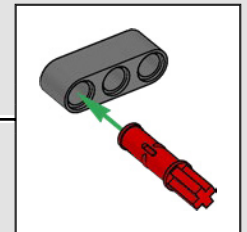

456

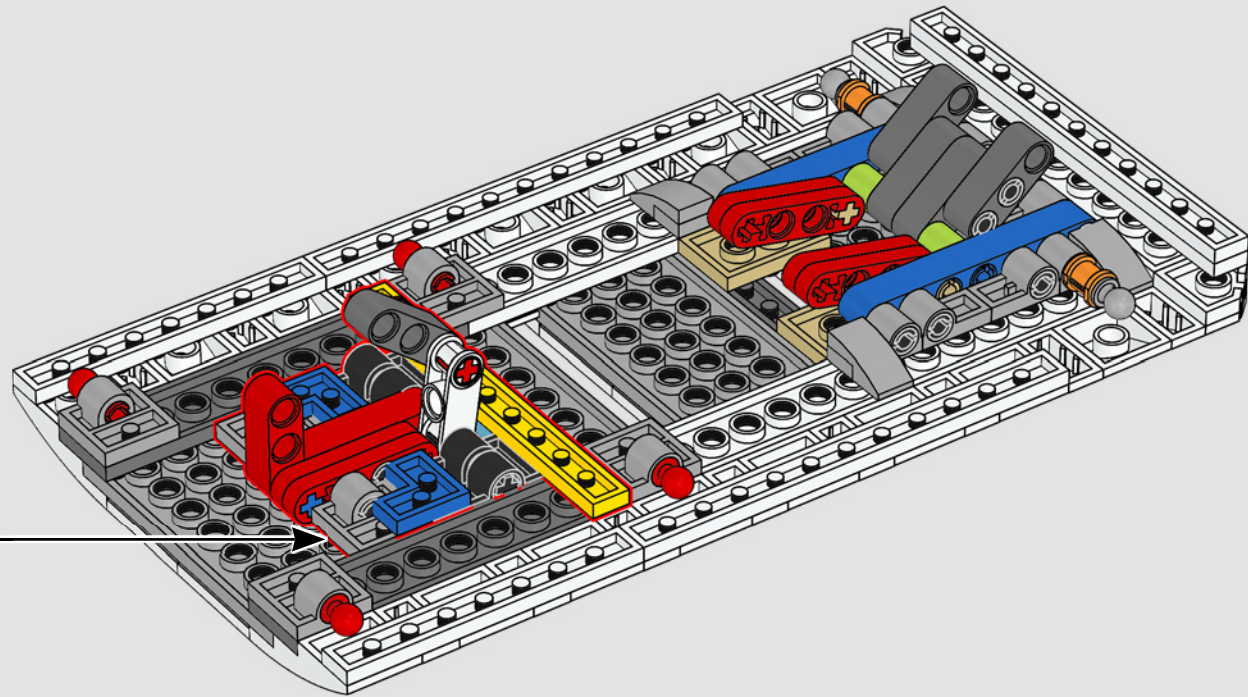

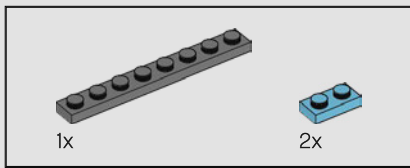

459

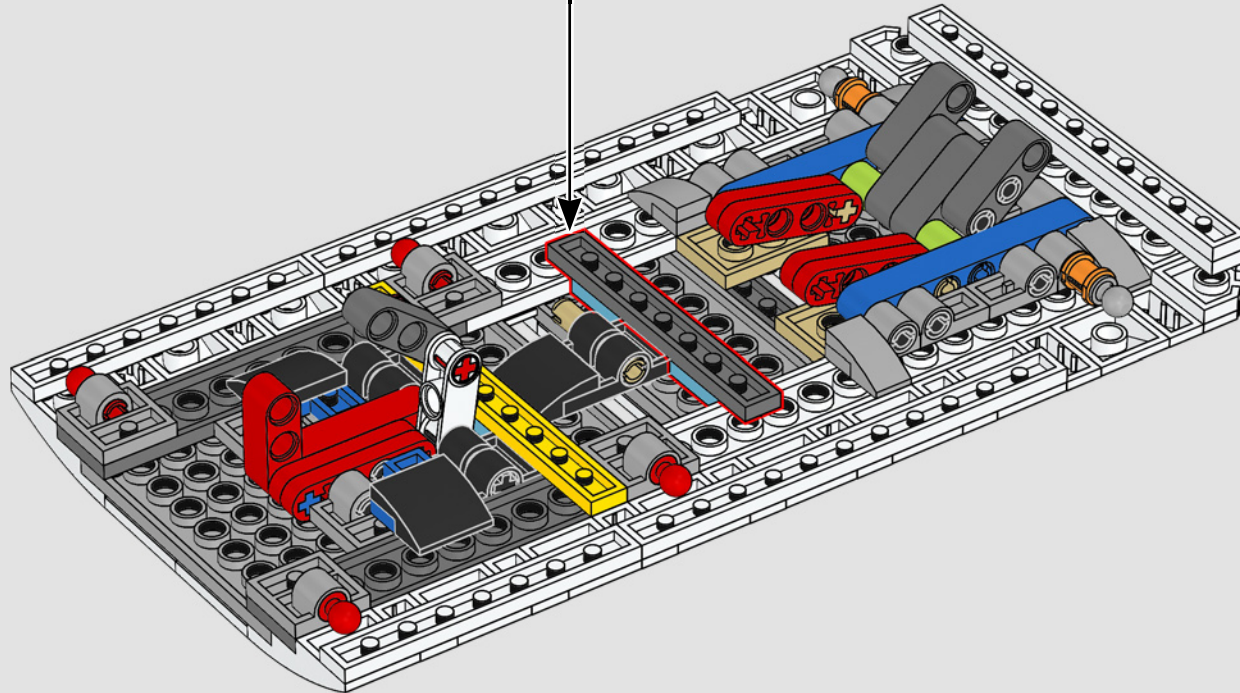
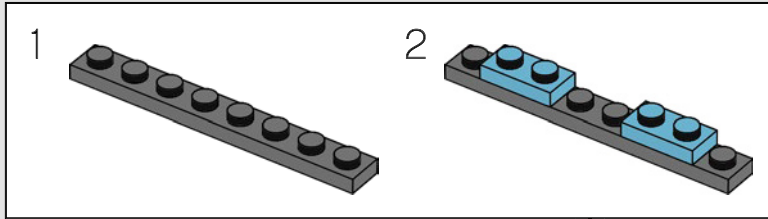

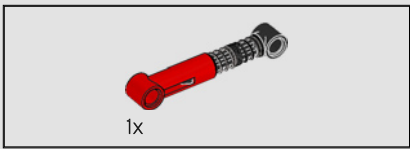

460

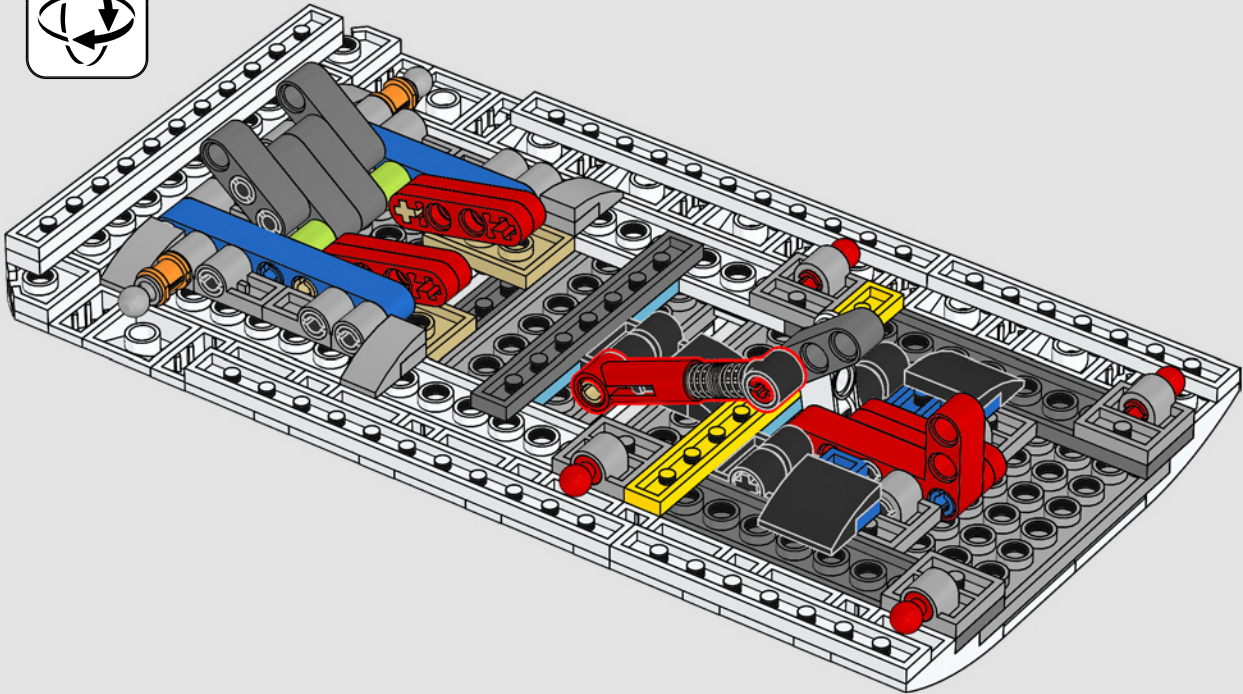

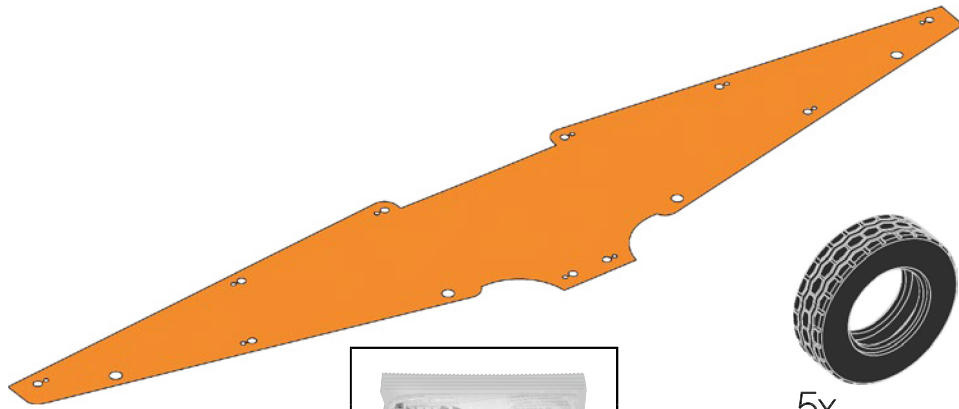

5x

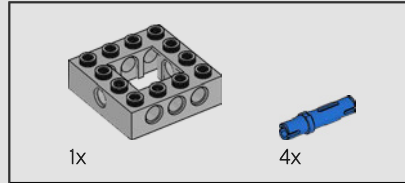
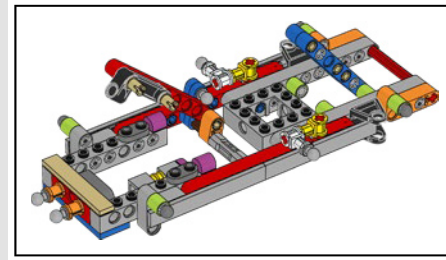
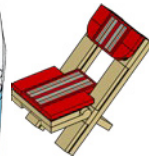
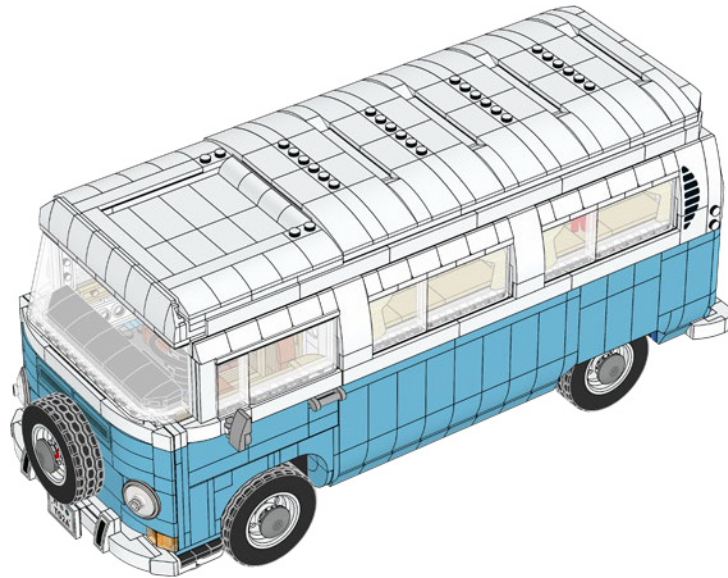
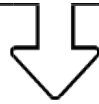

461

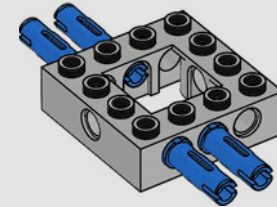



462

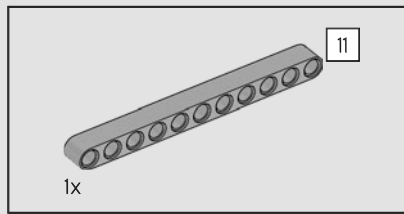
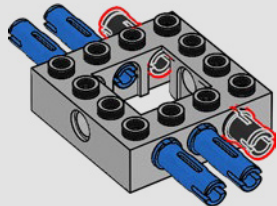

463

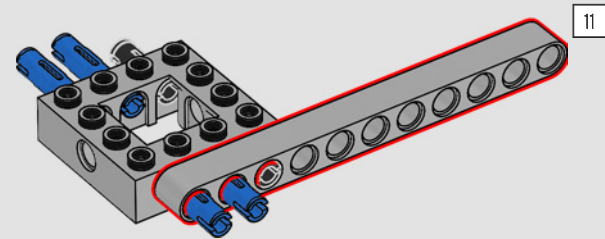

464

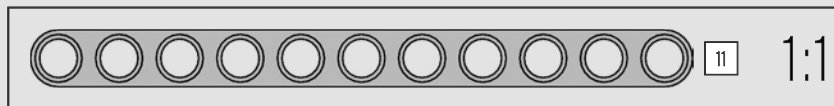
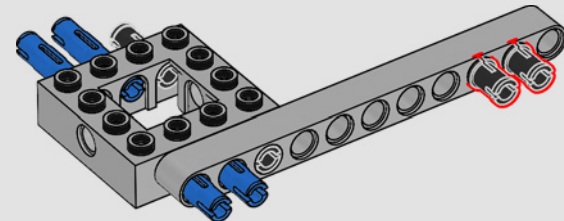

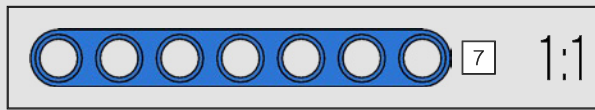
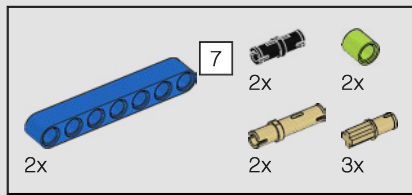

465

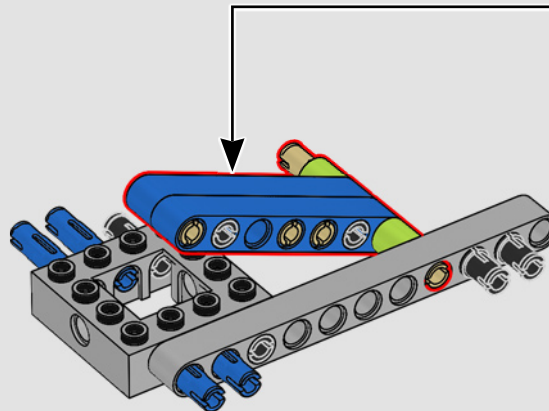
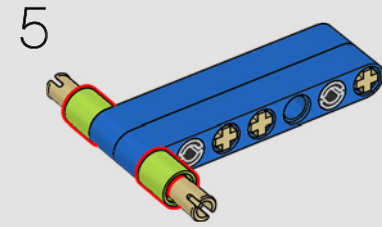
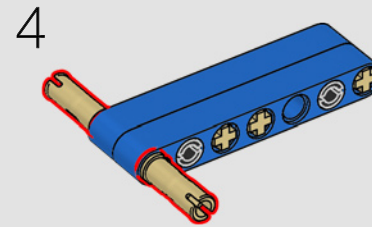
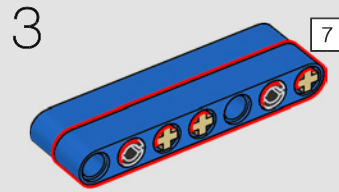
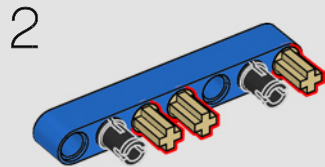
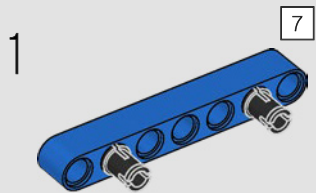

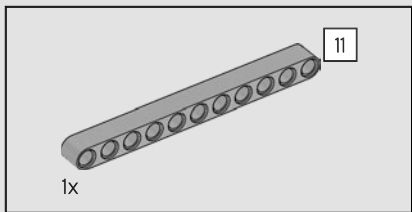

466

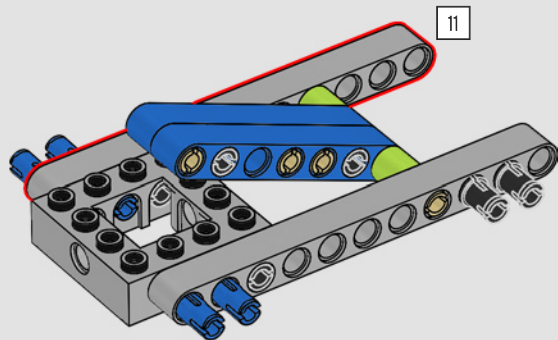

467

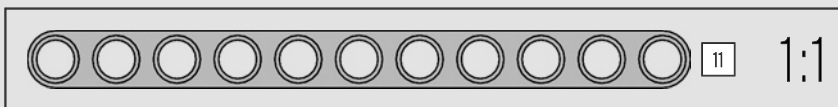
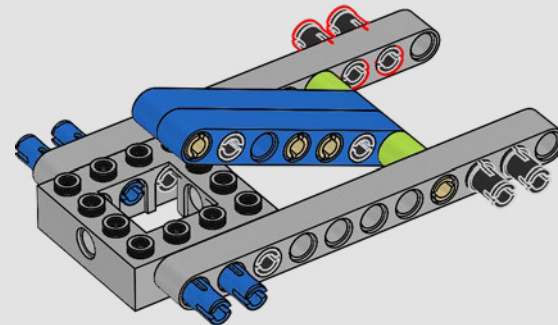

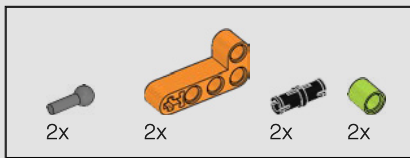

468

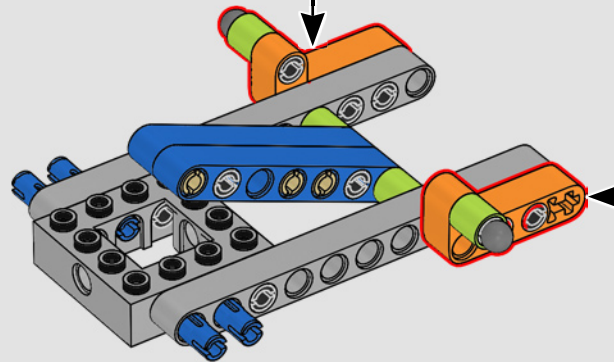
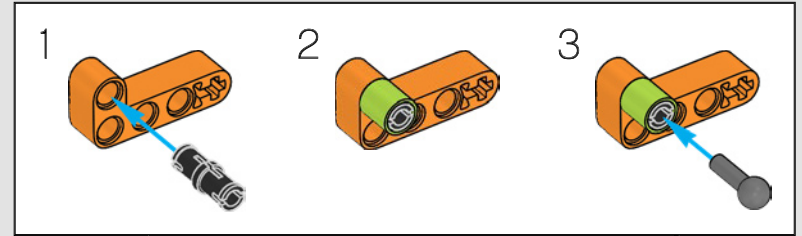
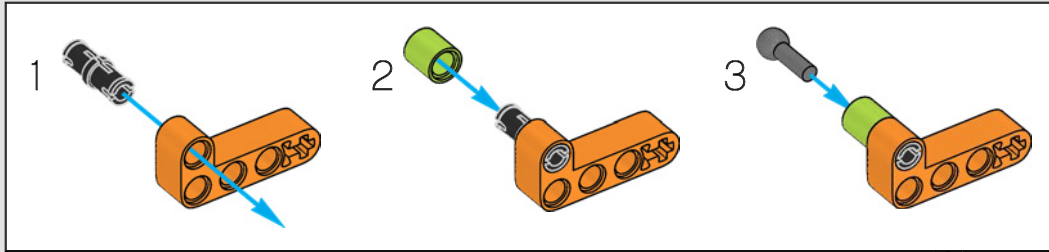



469

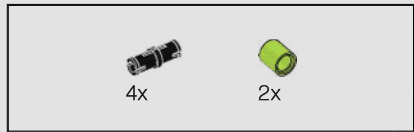
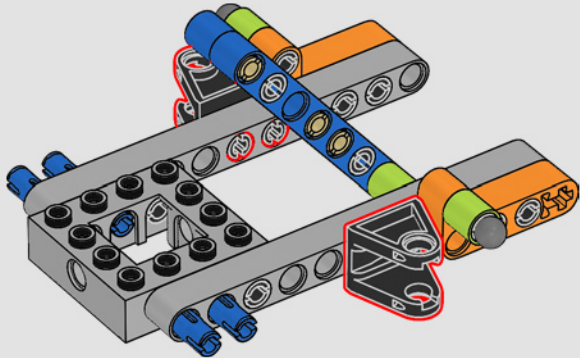

470

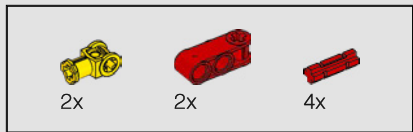
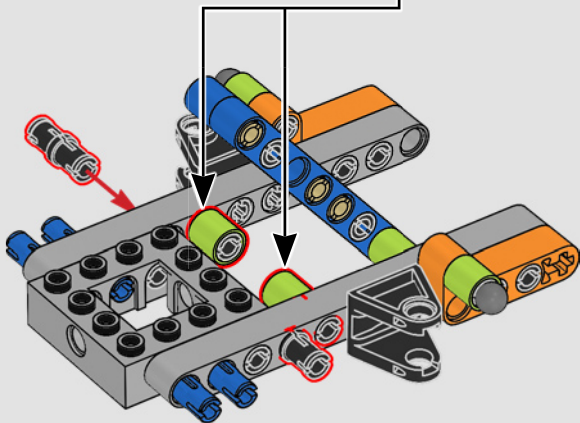
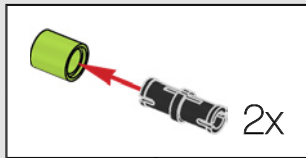

471

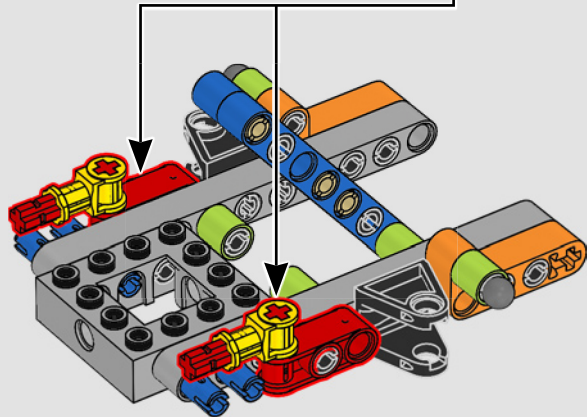
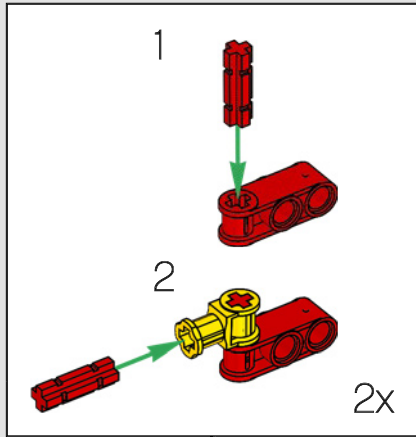

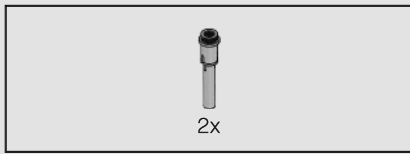

472

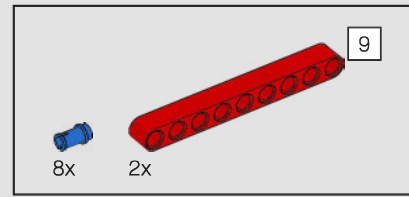
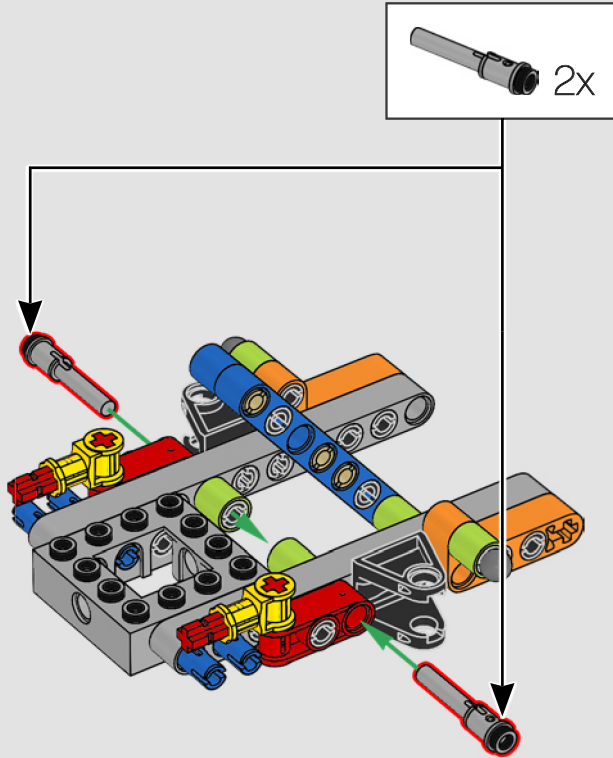

473

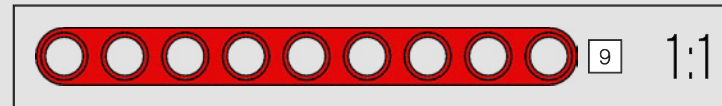
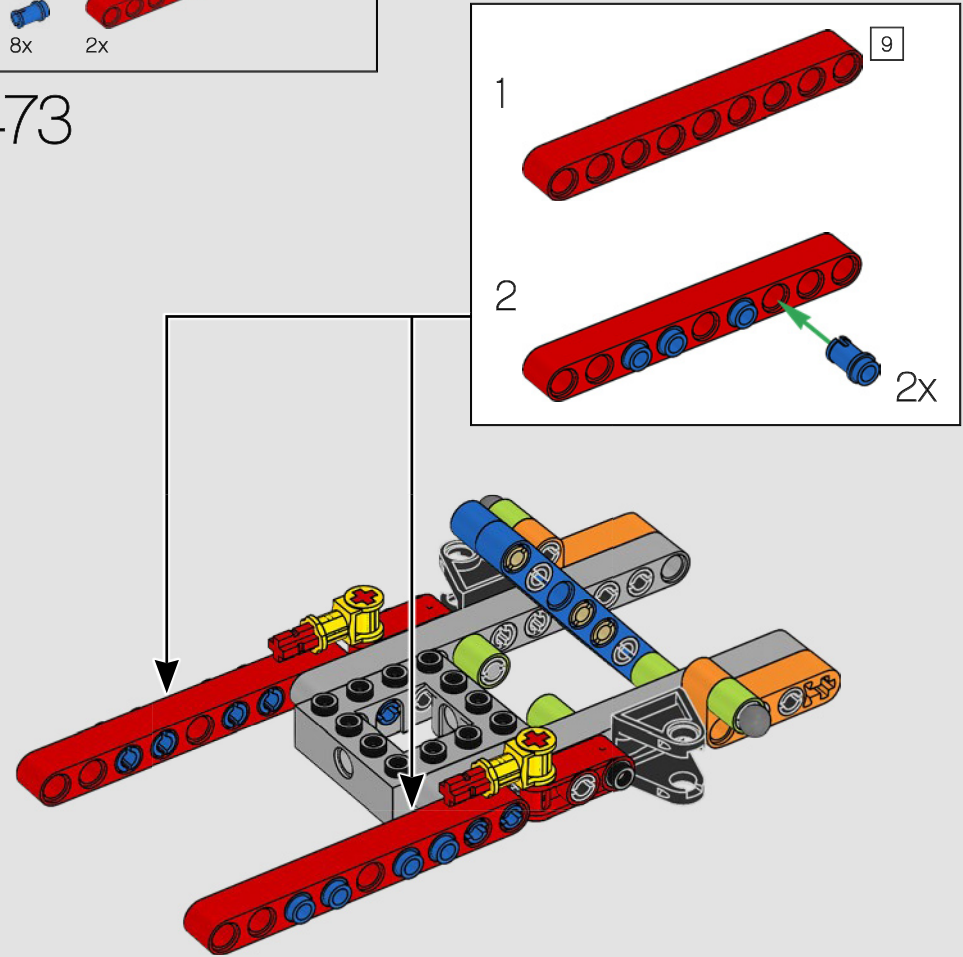



474

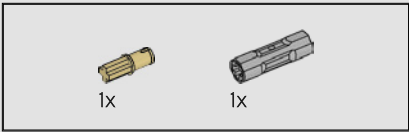
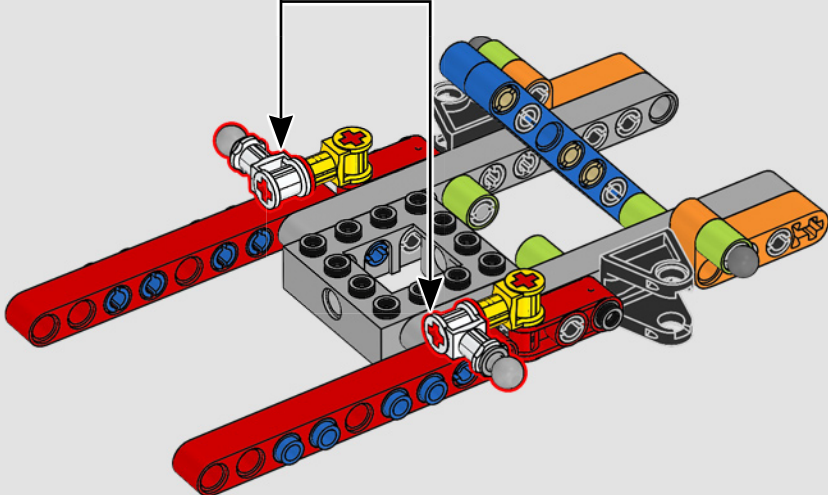
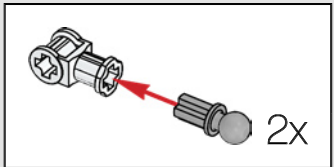

475

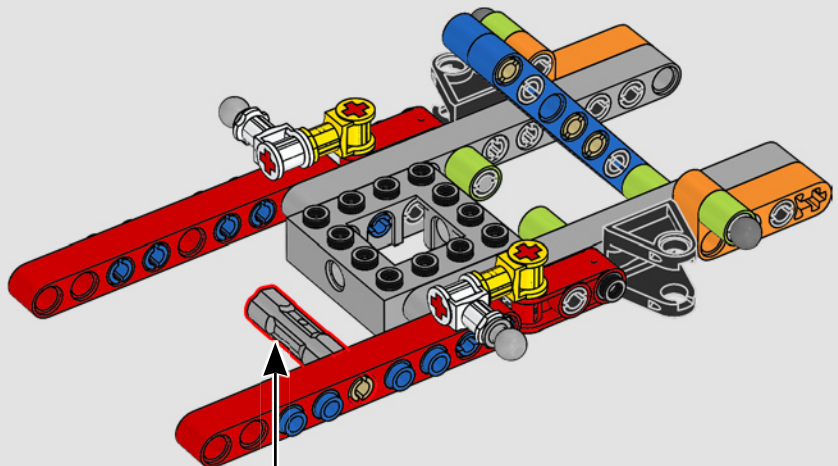
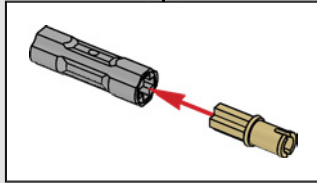

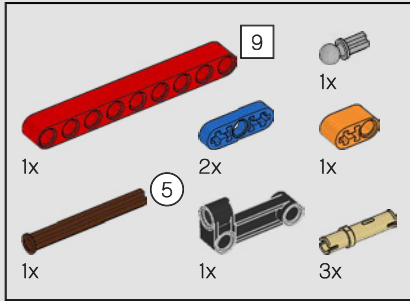
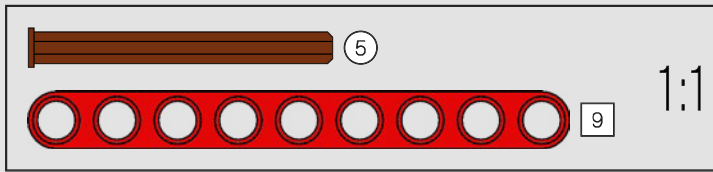
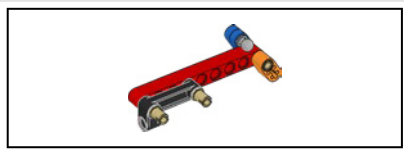

476

1

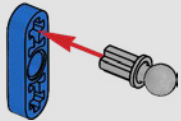

2

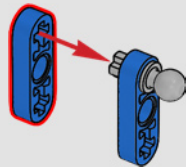

3

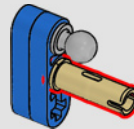

4

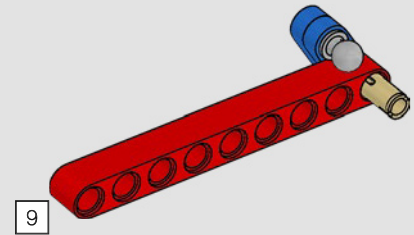

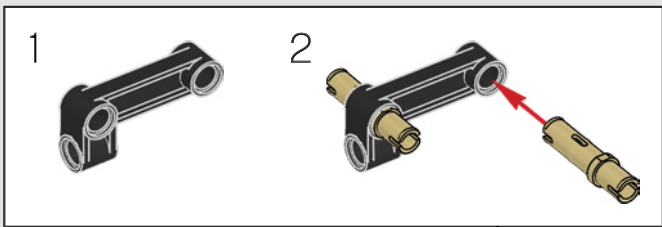

5

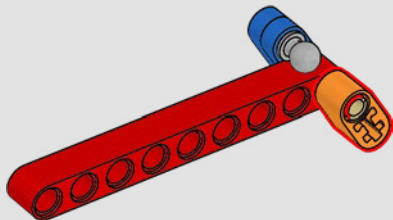

6

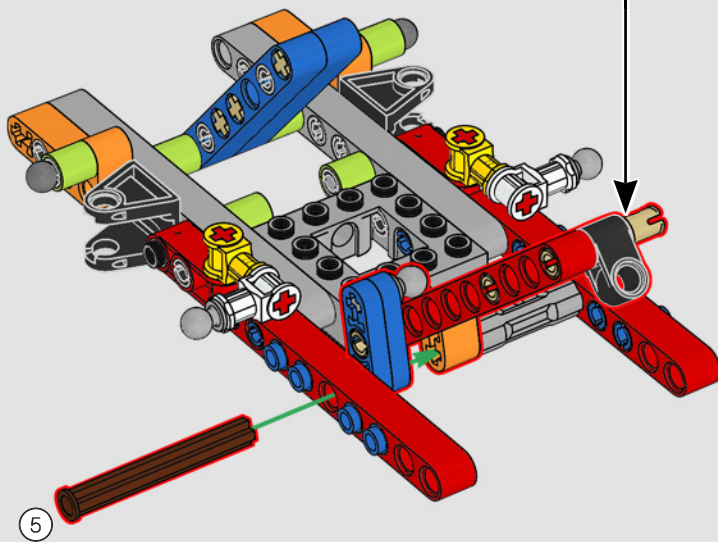
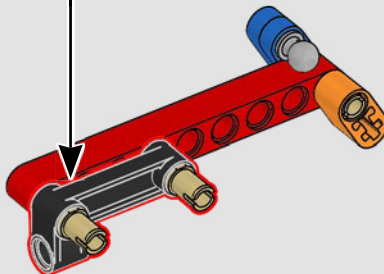

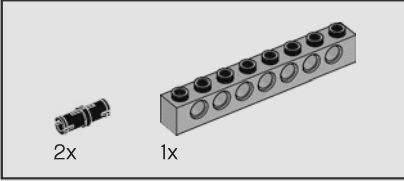
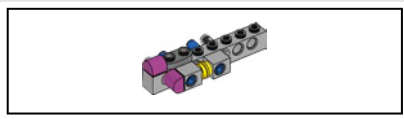

477

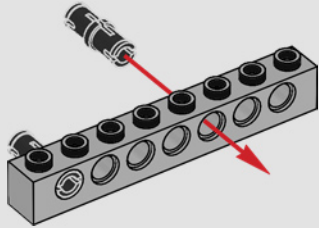

478

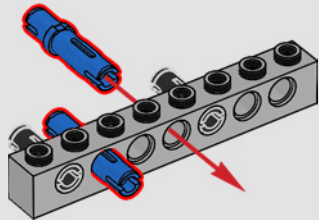

479

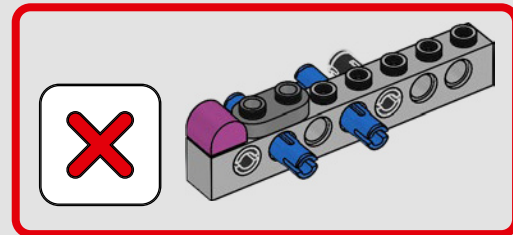
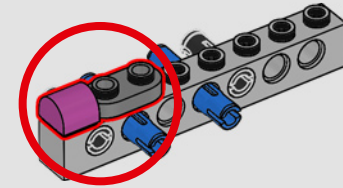



480

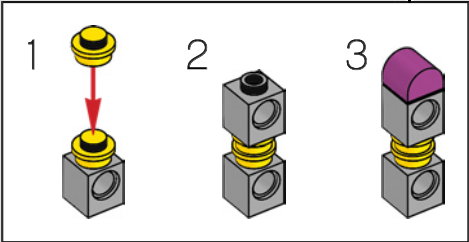
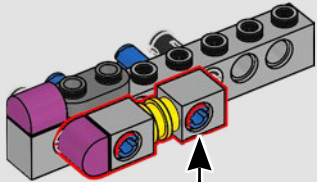
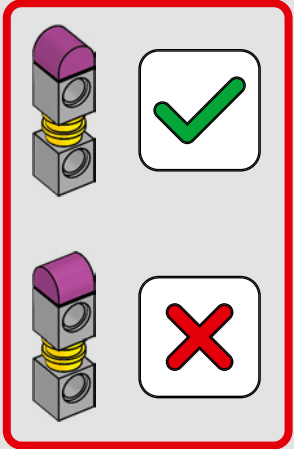

481

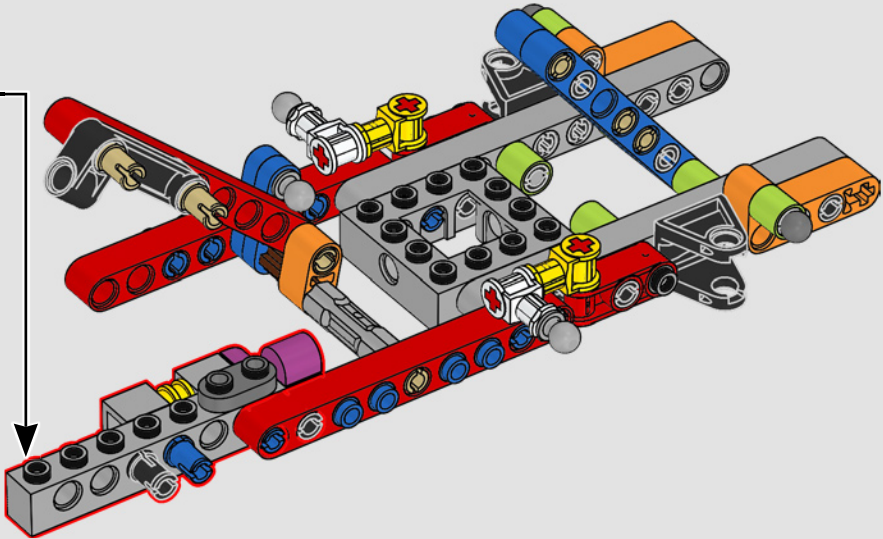

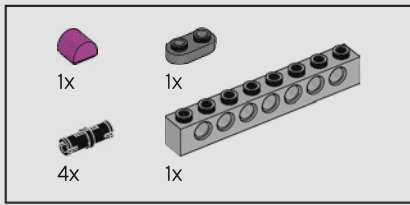

482

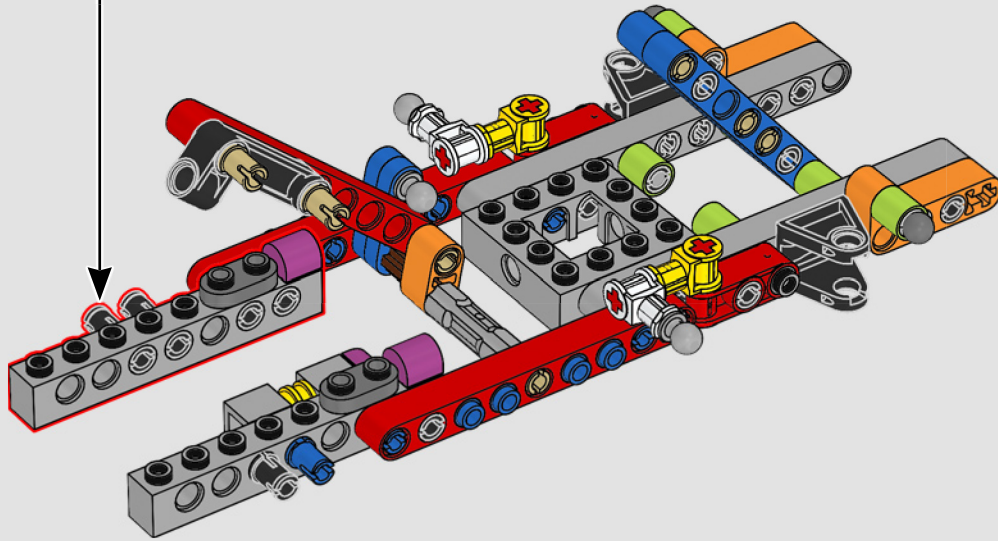
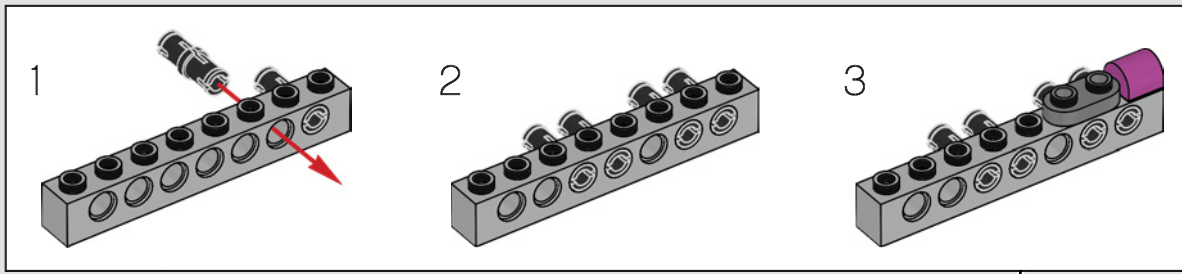

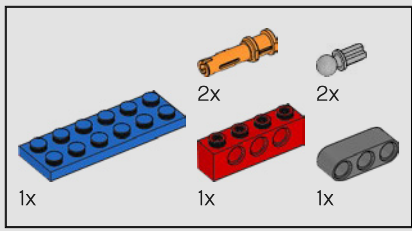

483

1

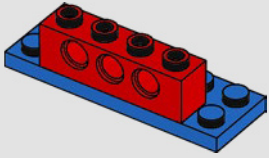

2

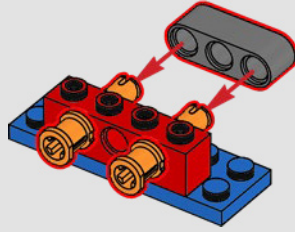

3

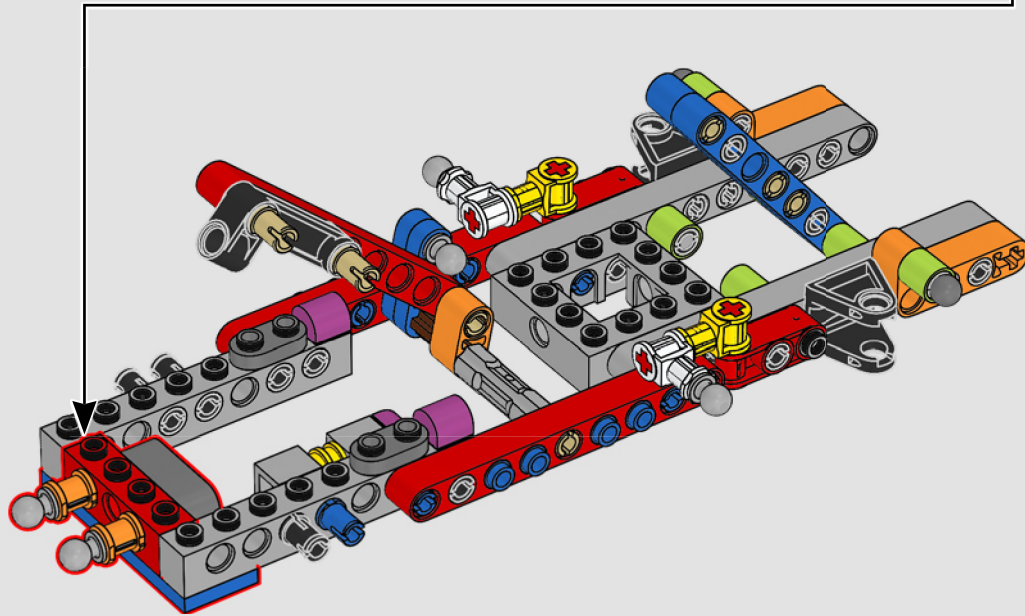
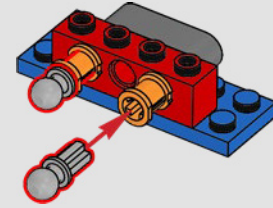

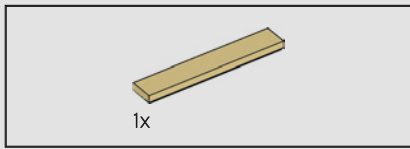

484

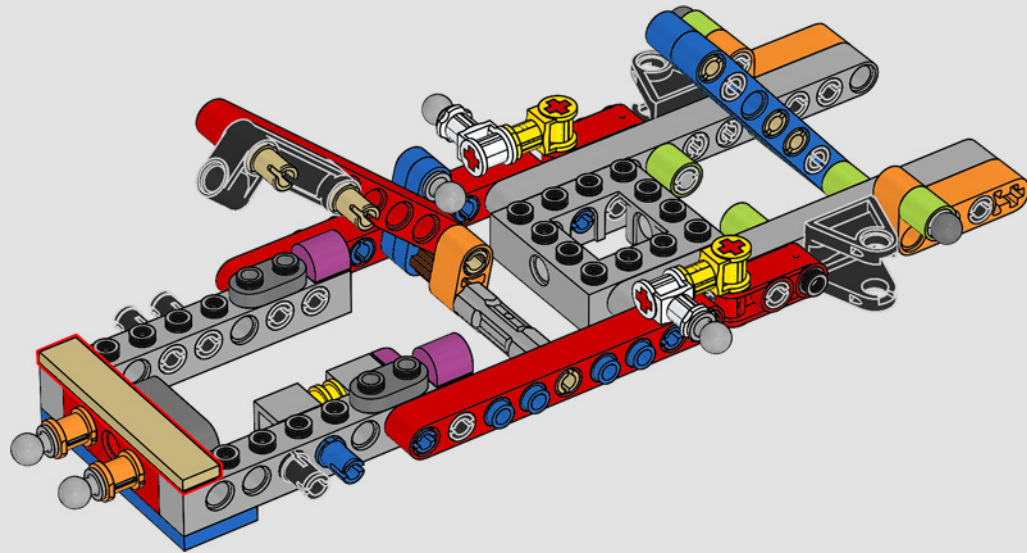

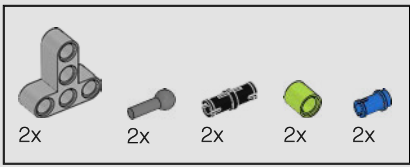

485

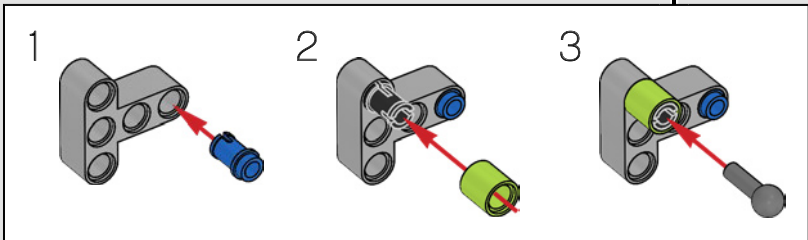
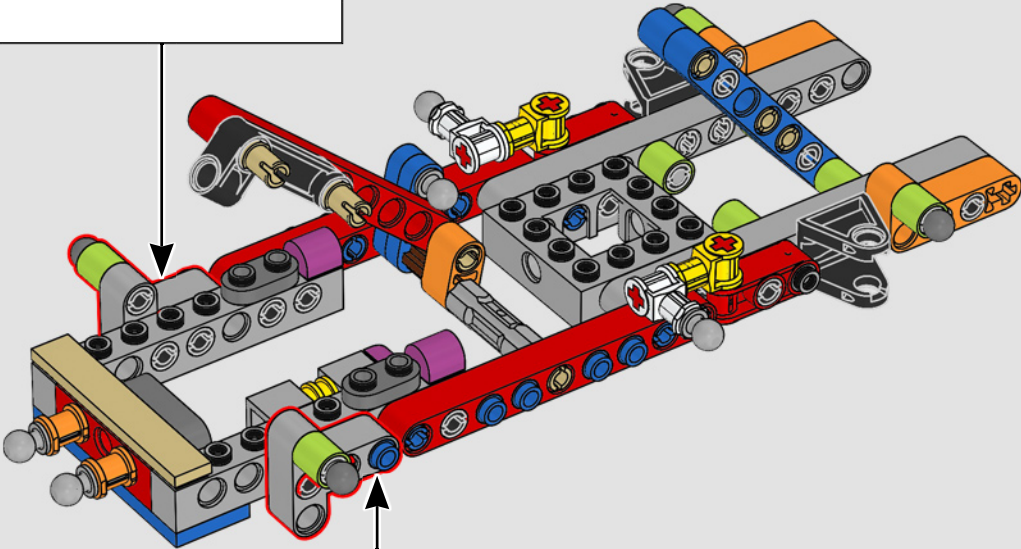
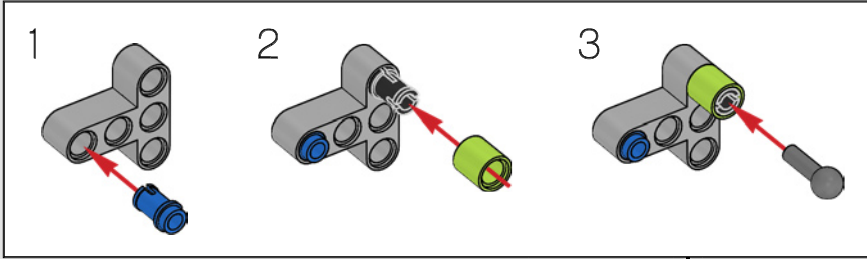

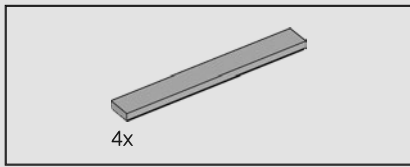

486

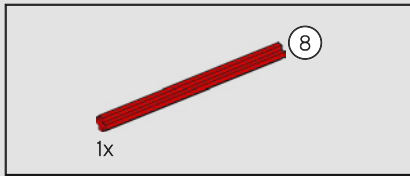
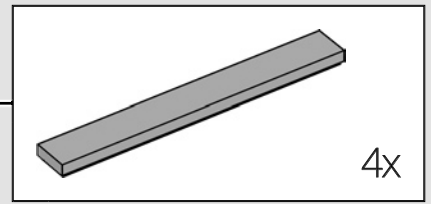
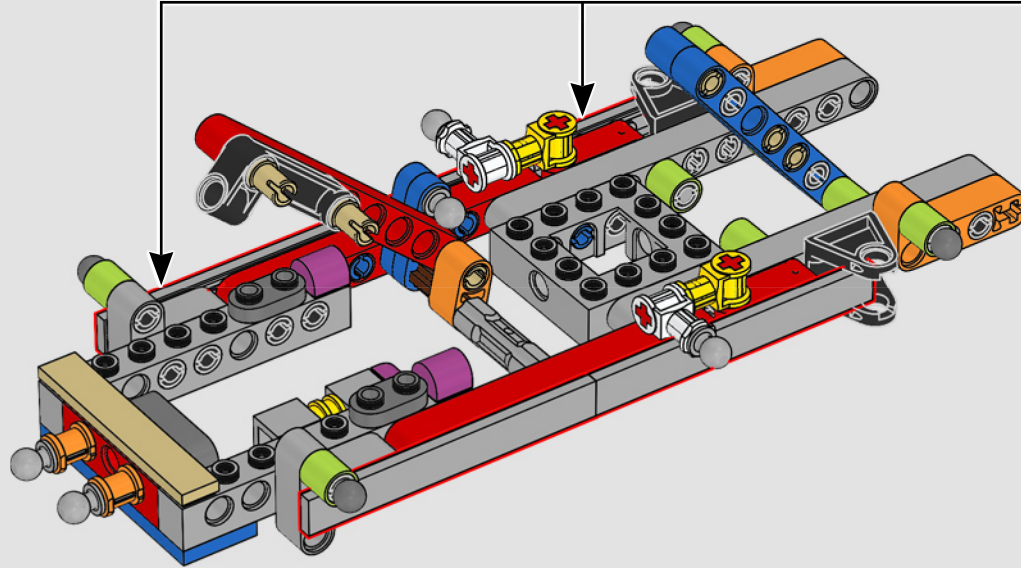

487

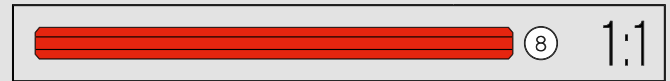
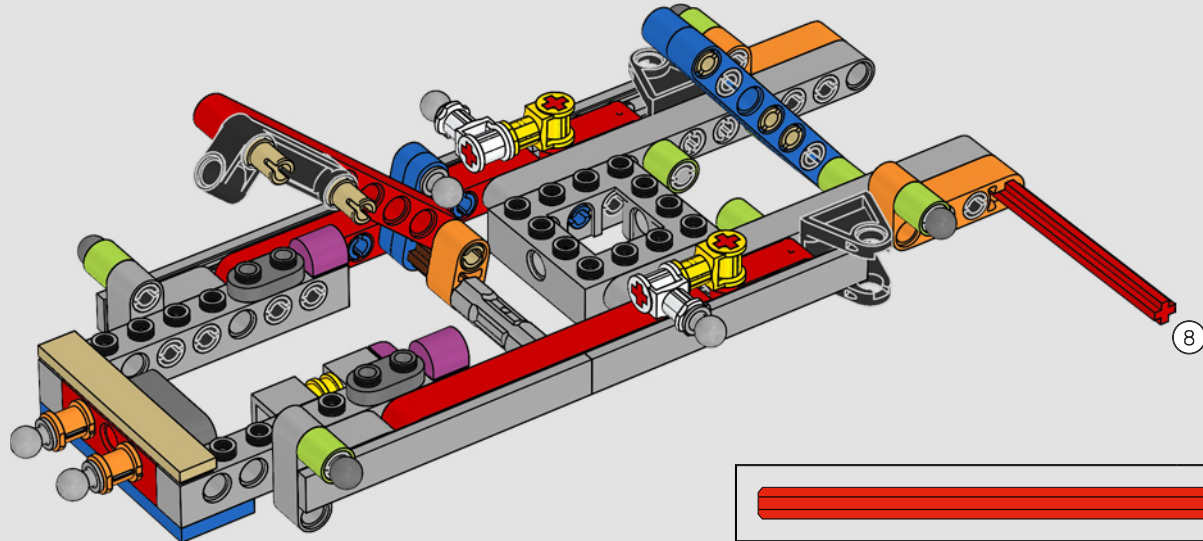

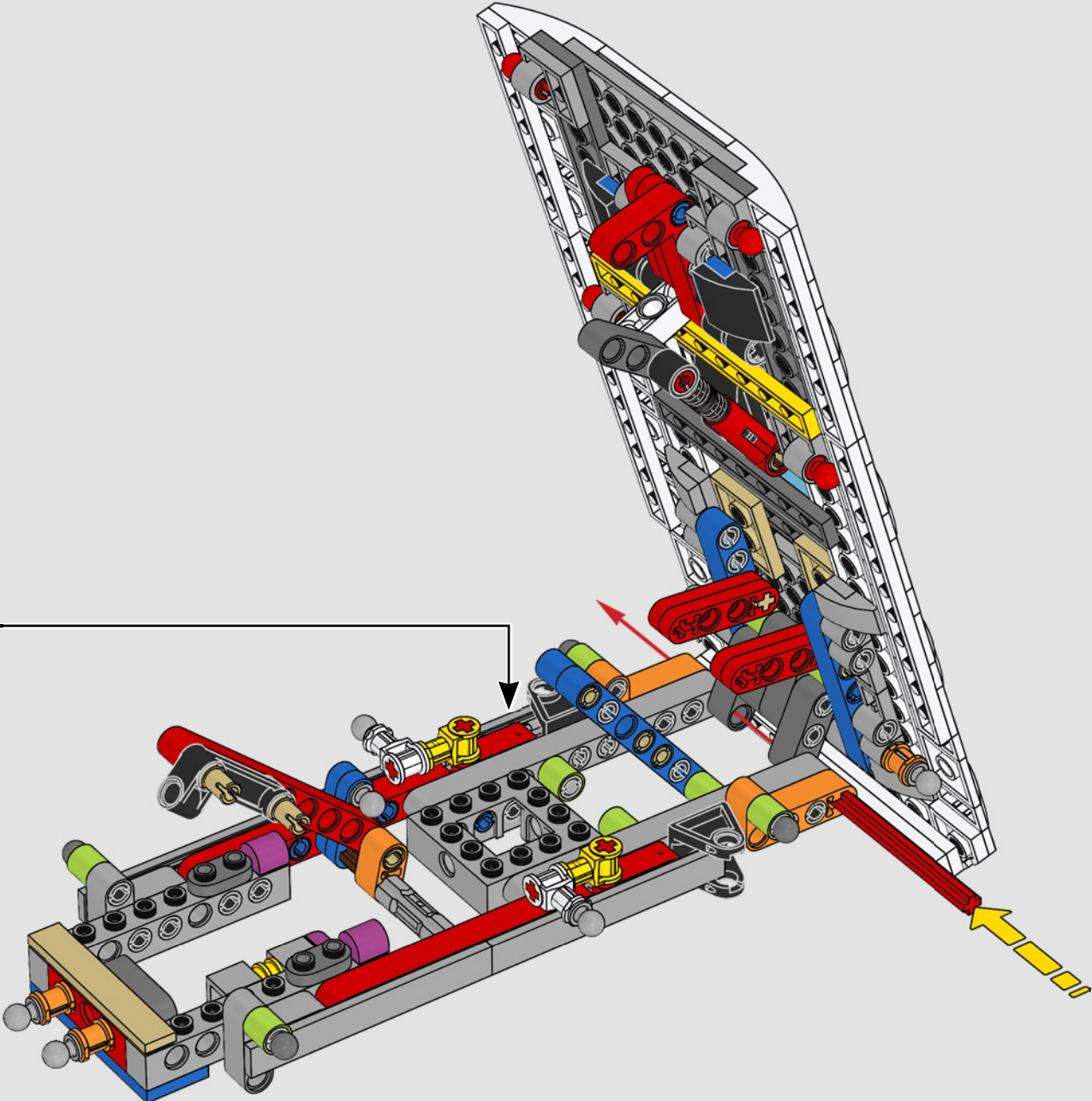

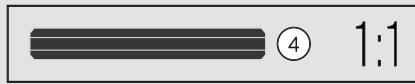
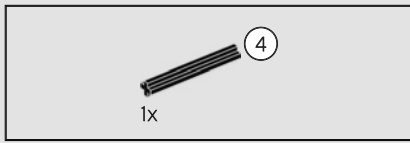

489

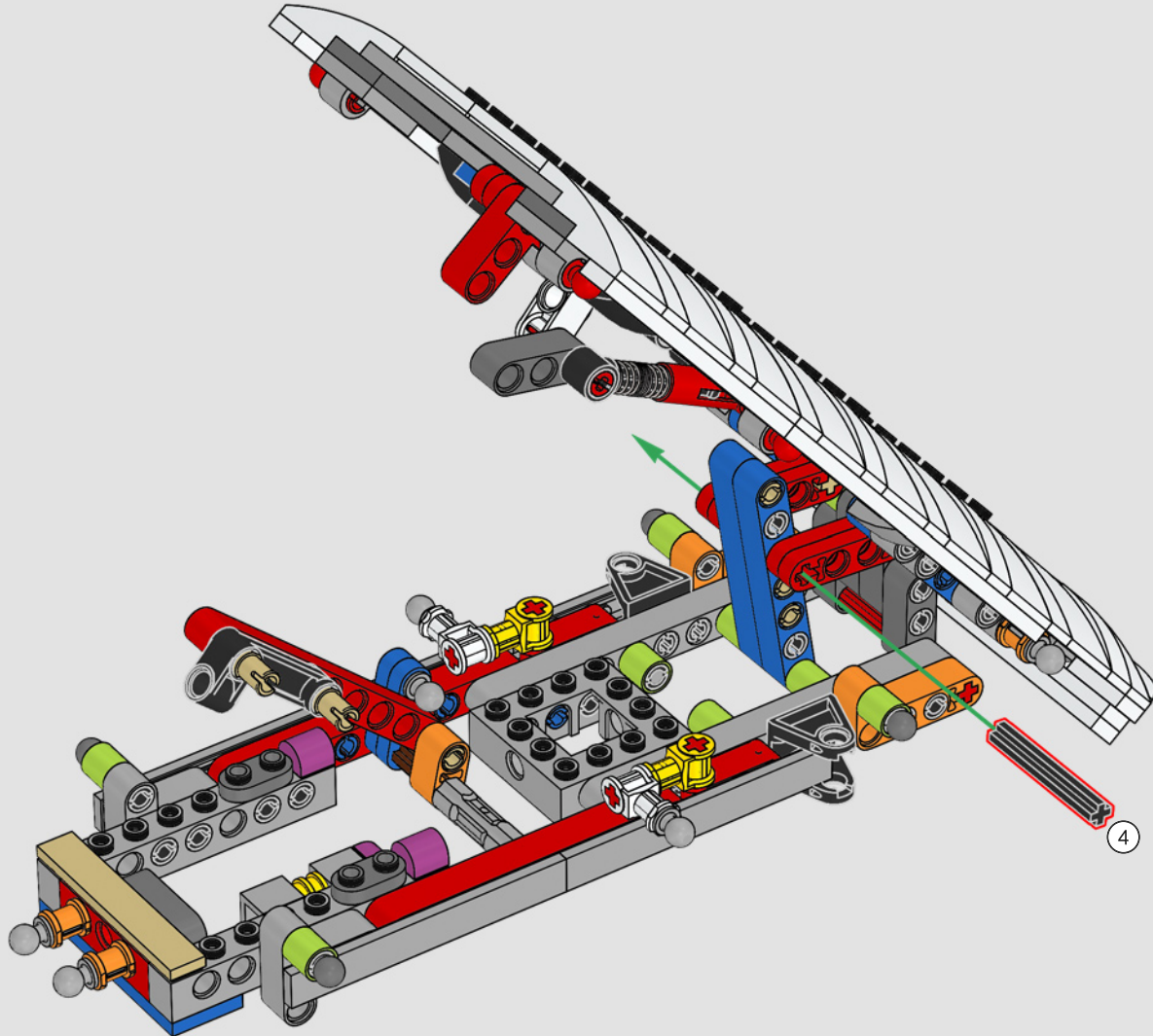

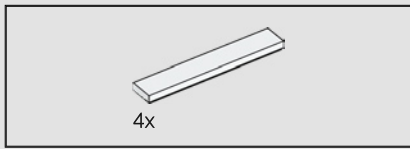

491

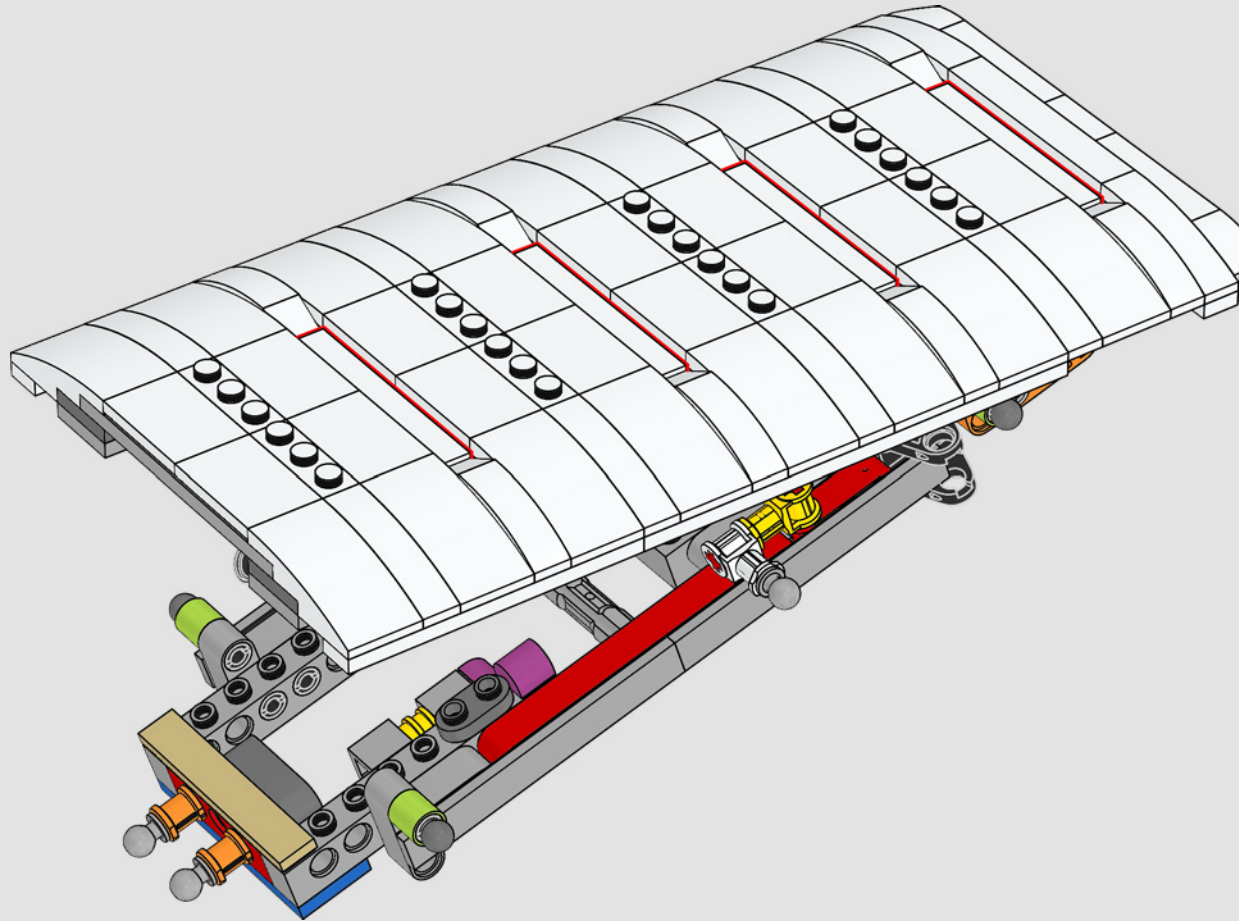

492

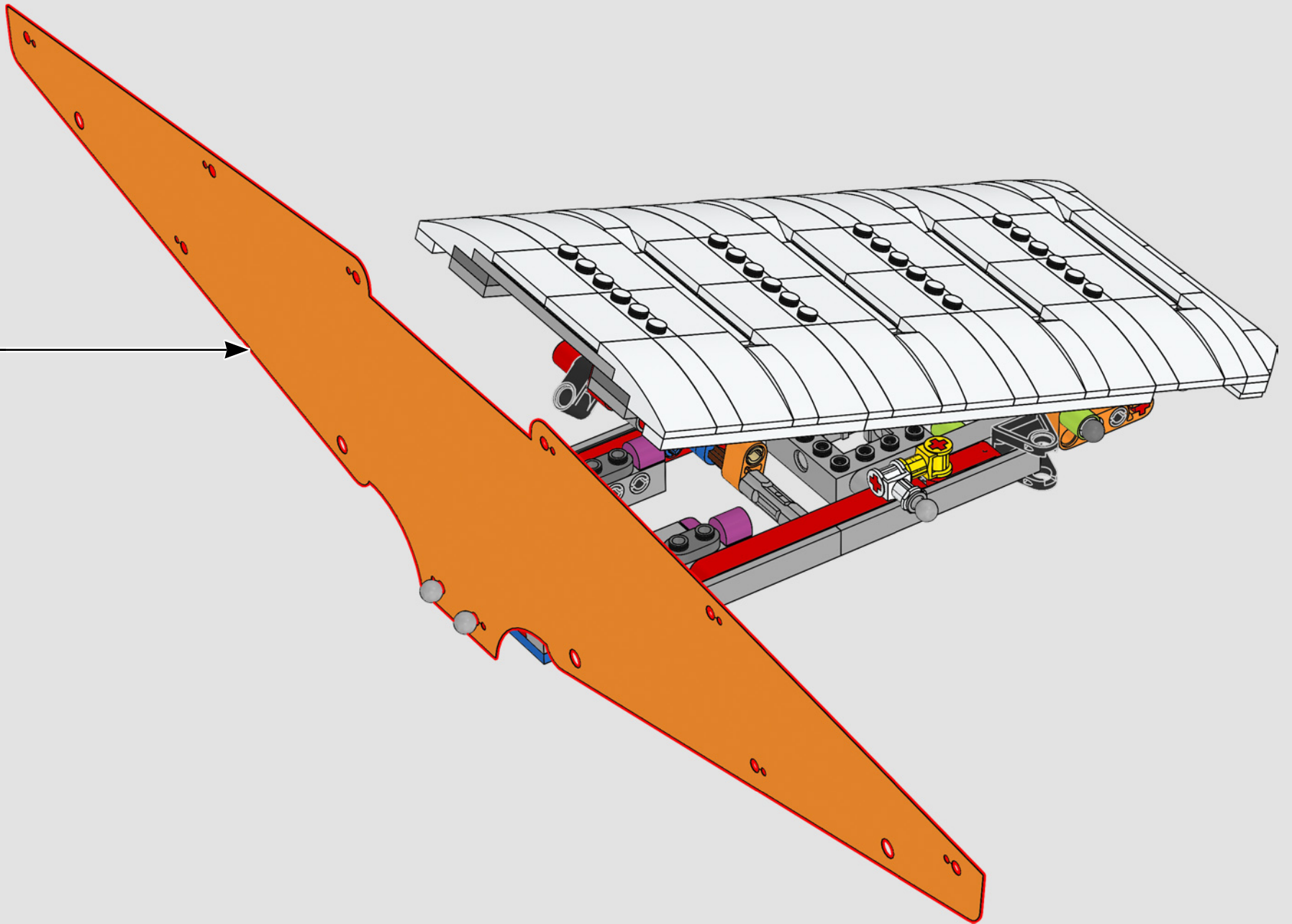

Molte conversioni di camper T2 presentavano anche questo tetto da campeggio pop-up per offrire ai viaggiatori l'altezza necessaria per stare in piedi durante le soste.

493

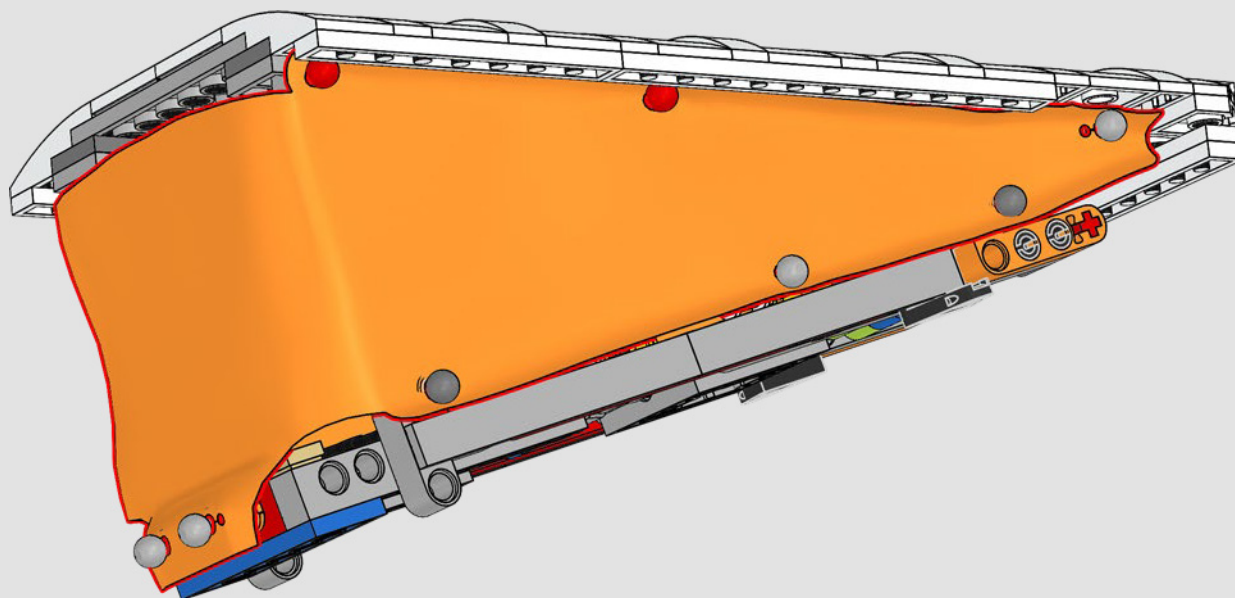

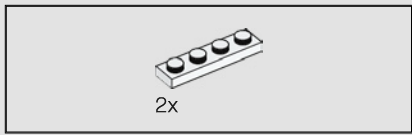

494

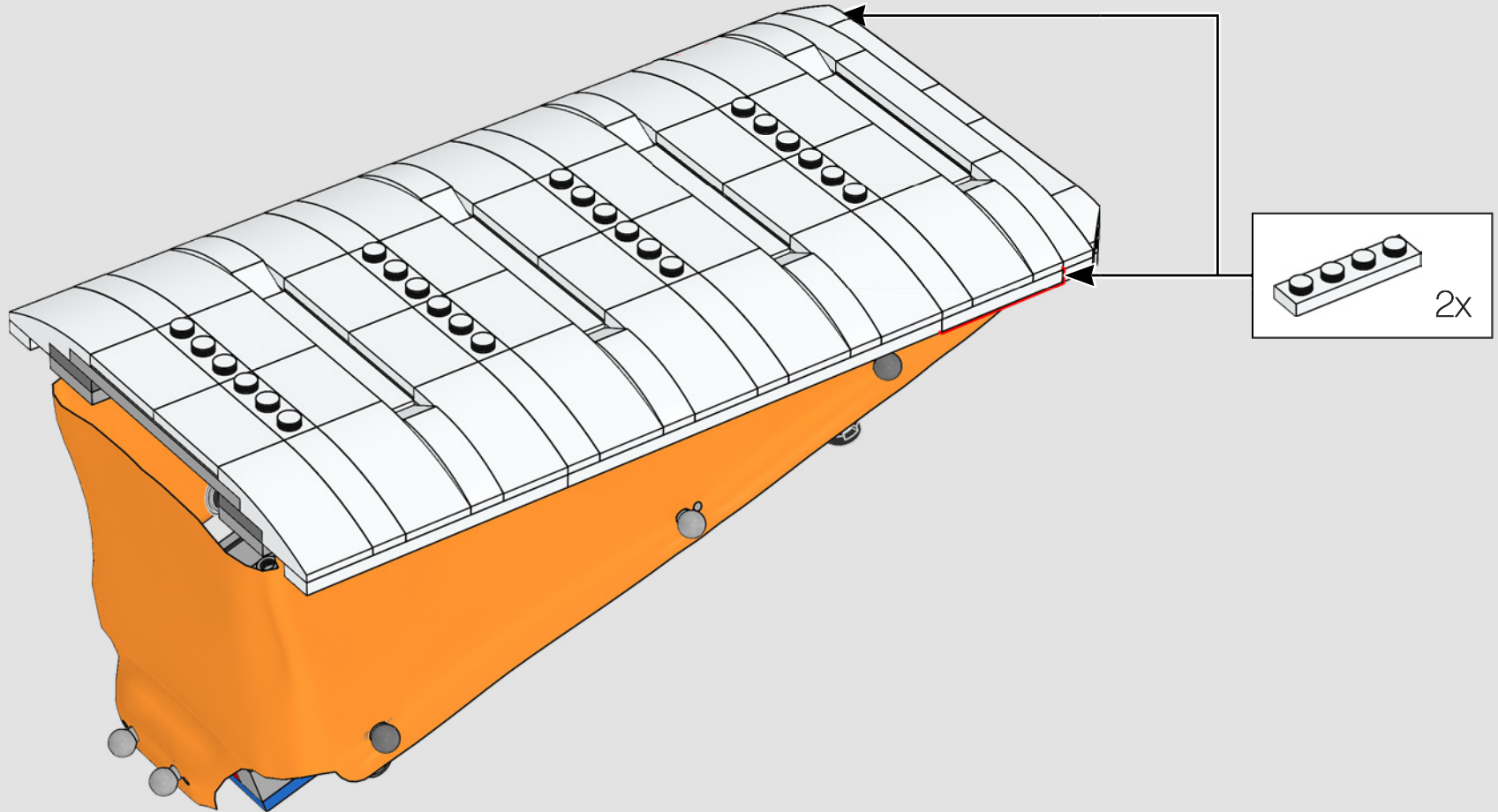

495

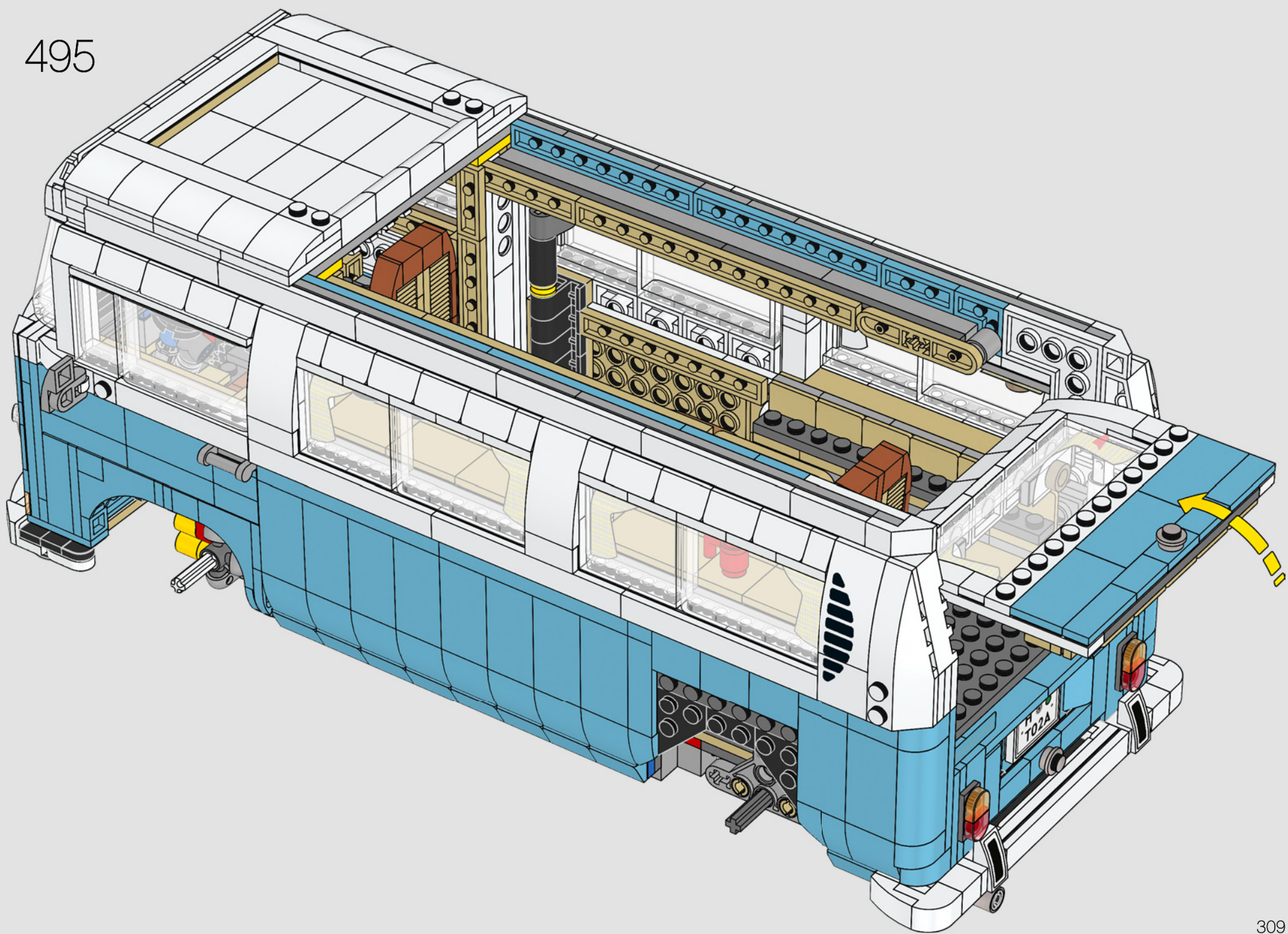

496

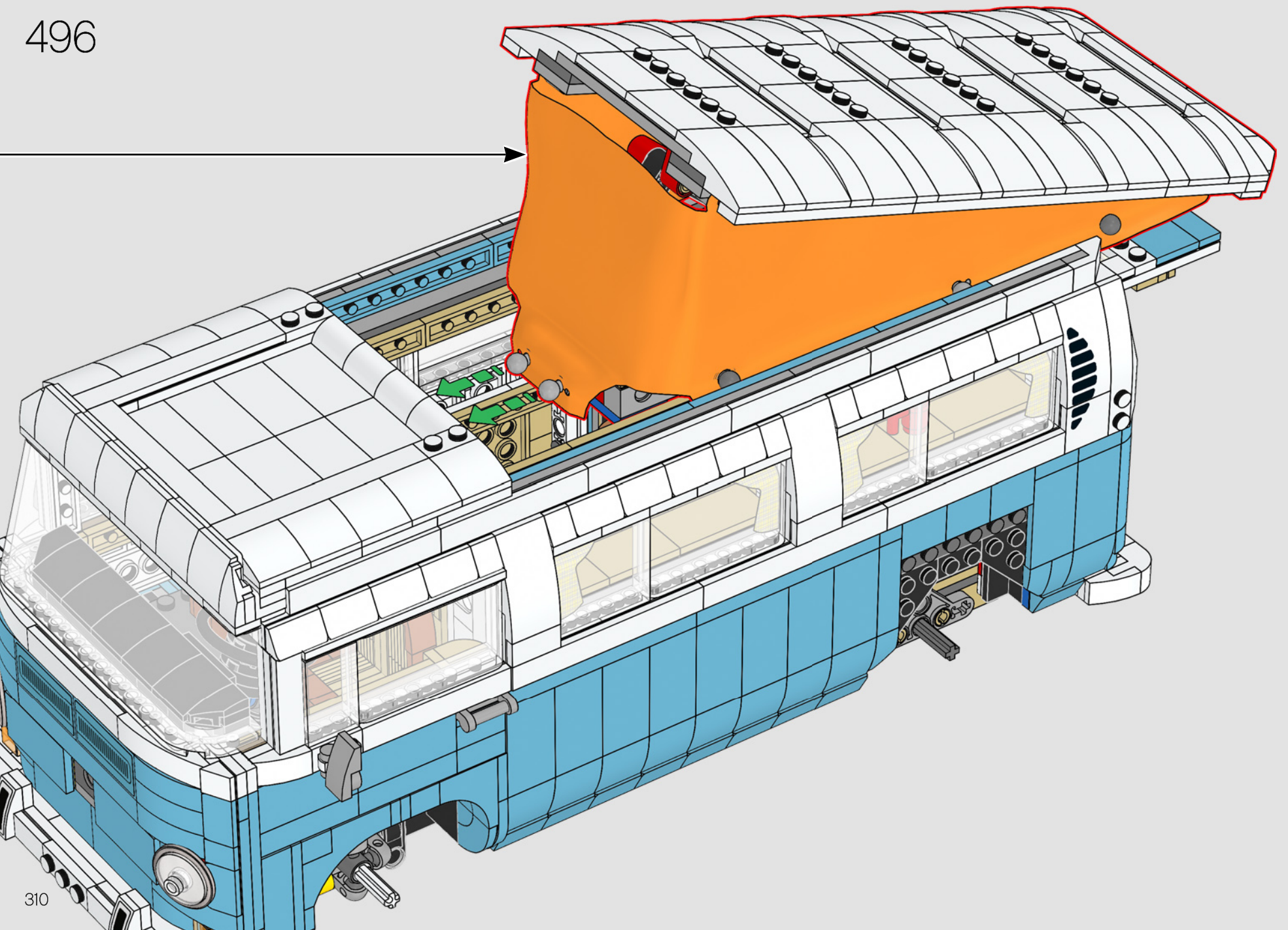

310

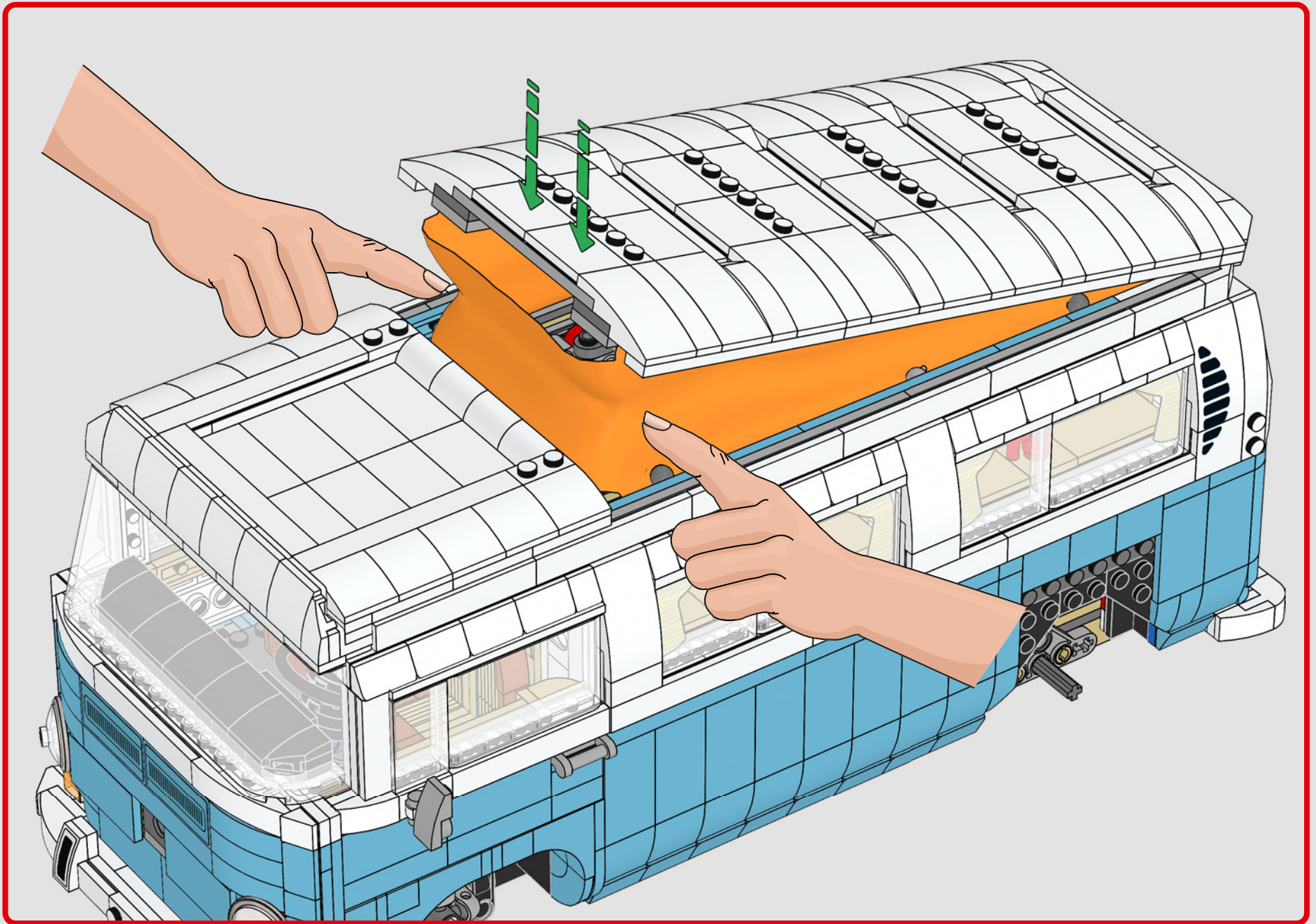

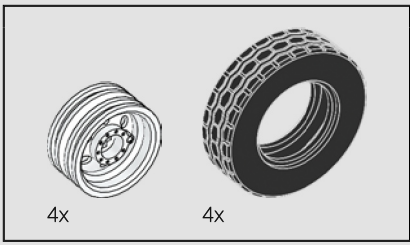

497

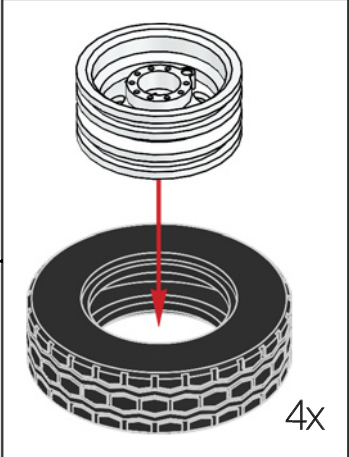
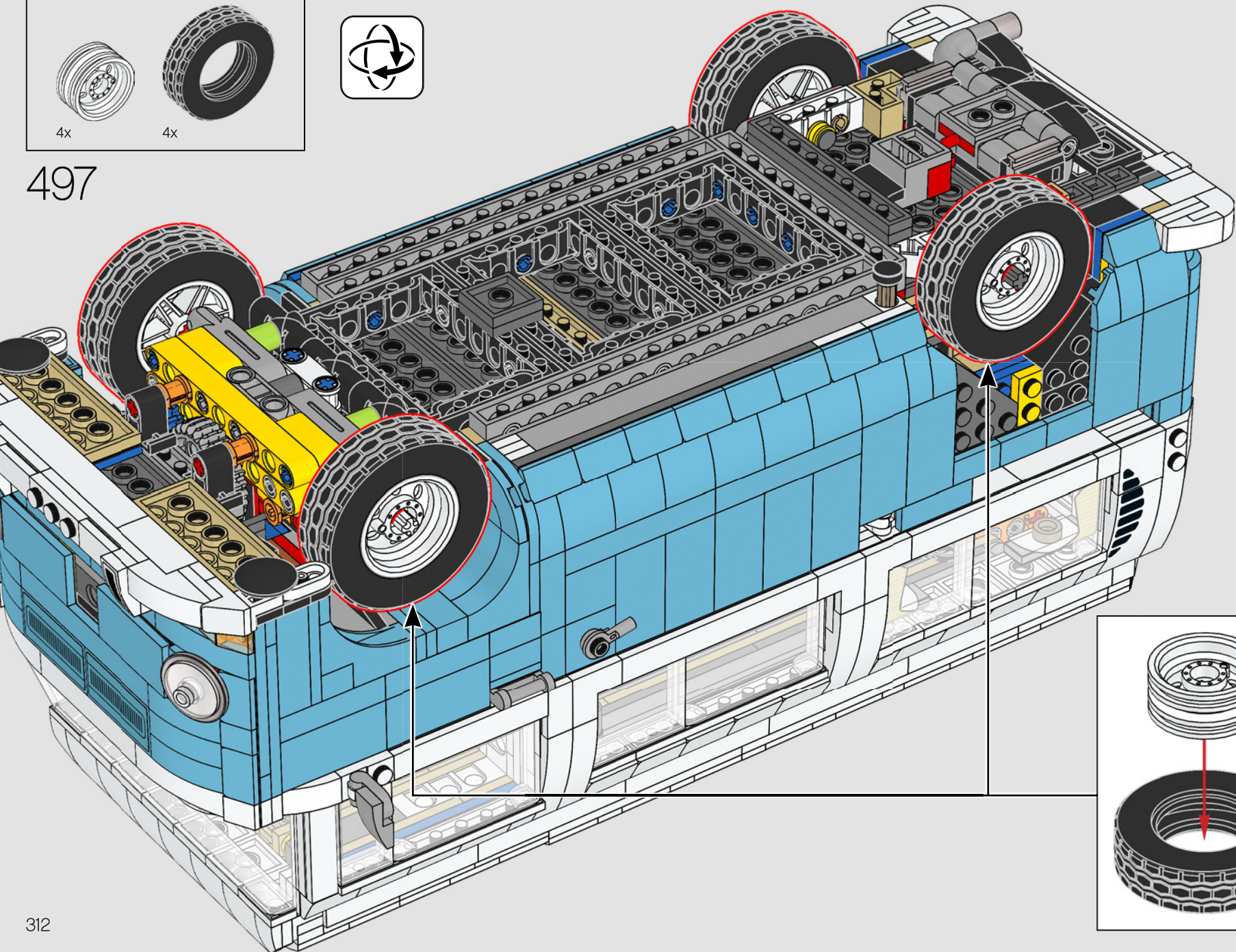

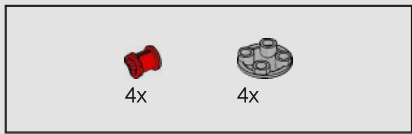

498

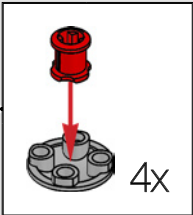
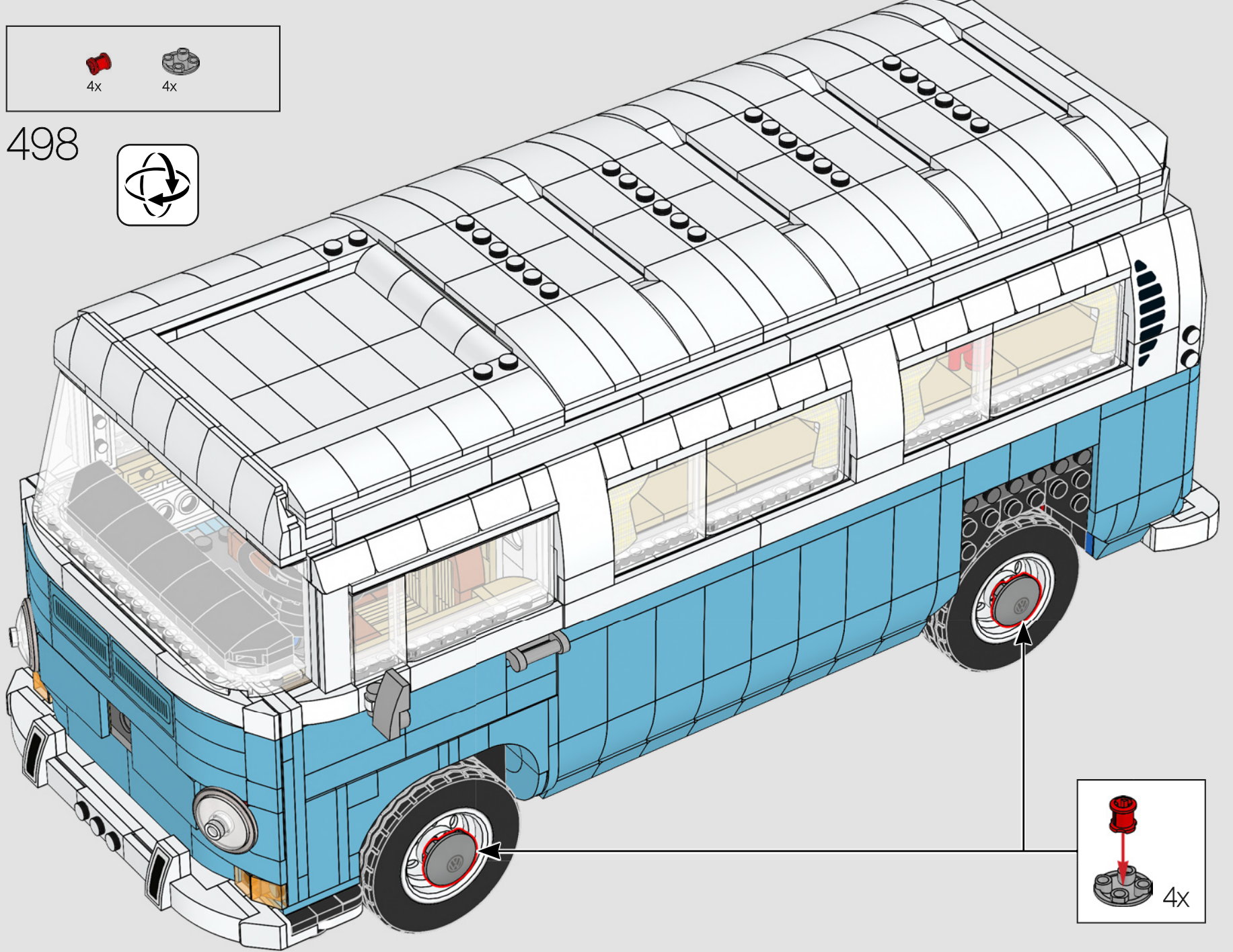

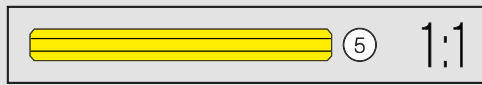
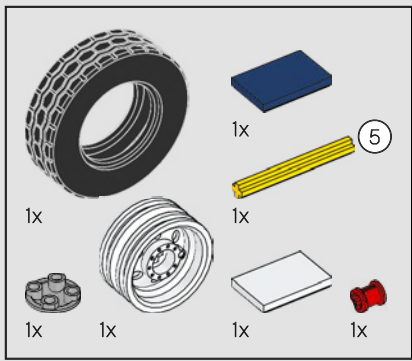



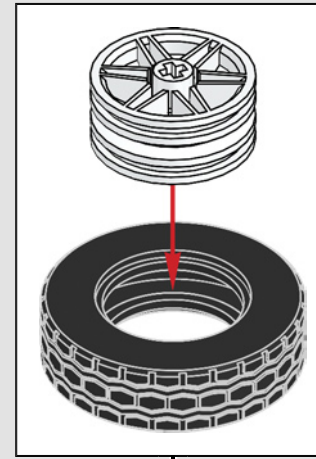
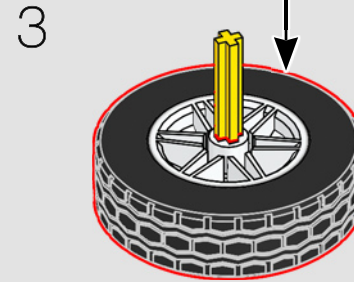
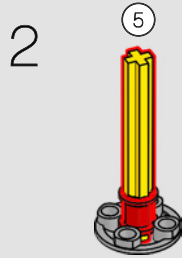
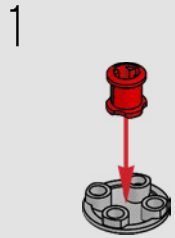

499

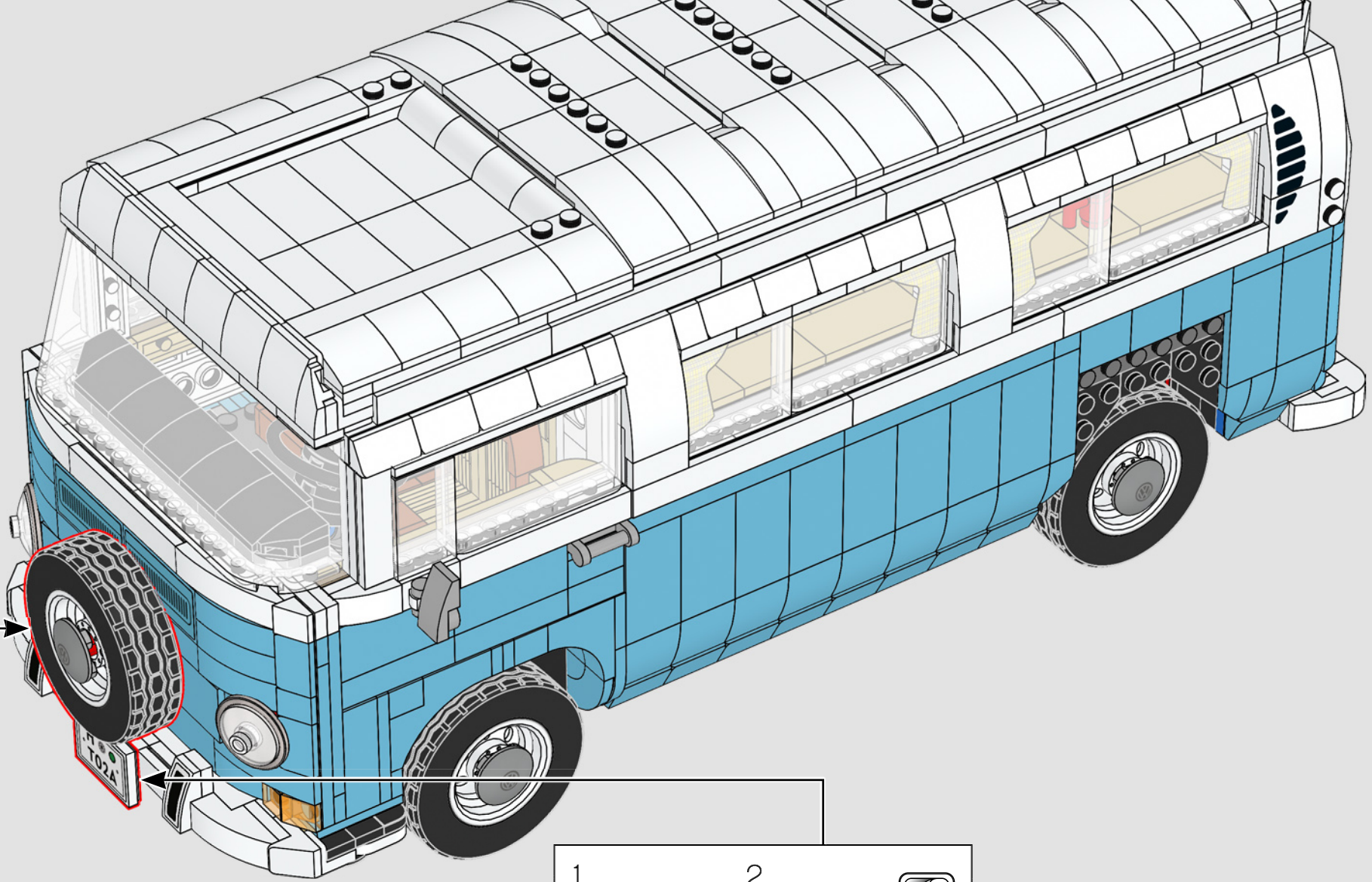

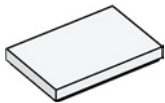
Per risparmiare spazio prezioso in cabina, era pratica comune montare la ruota di scorta sul pannello anteriore esterno.

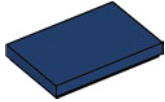

- | | | | | | |
|---|--|---|---|---|---|
| 1 |  | 2 |  |  | 2 |
| |  | |  |  | 4 |

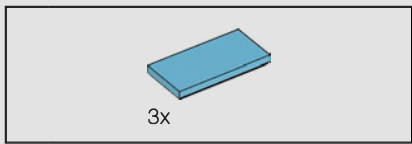

500

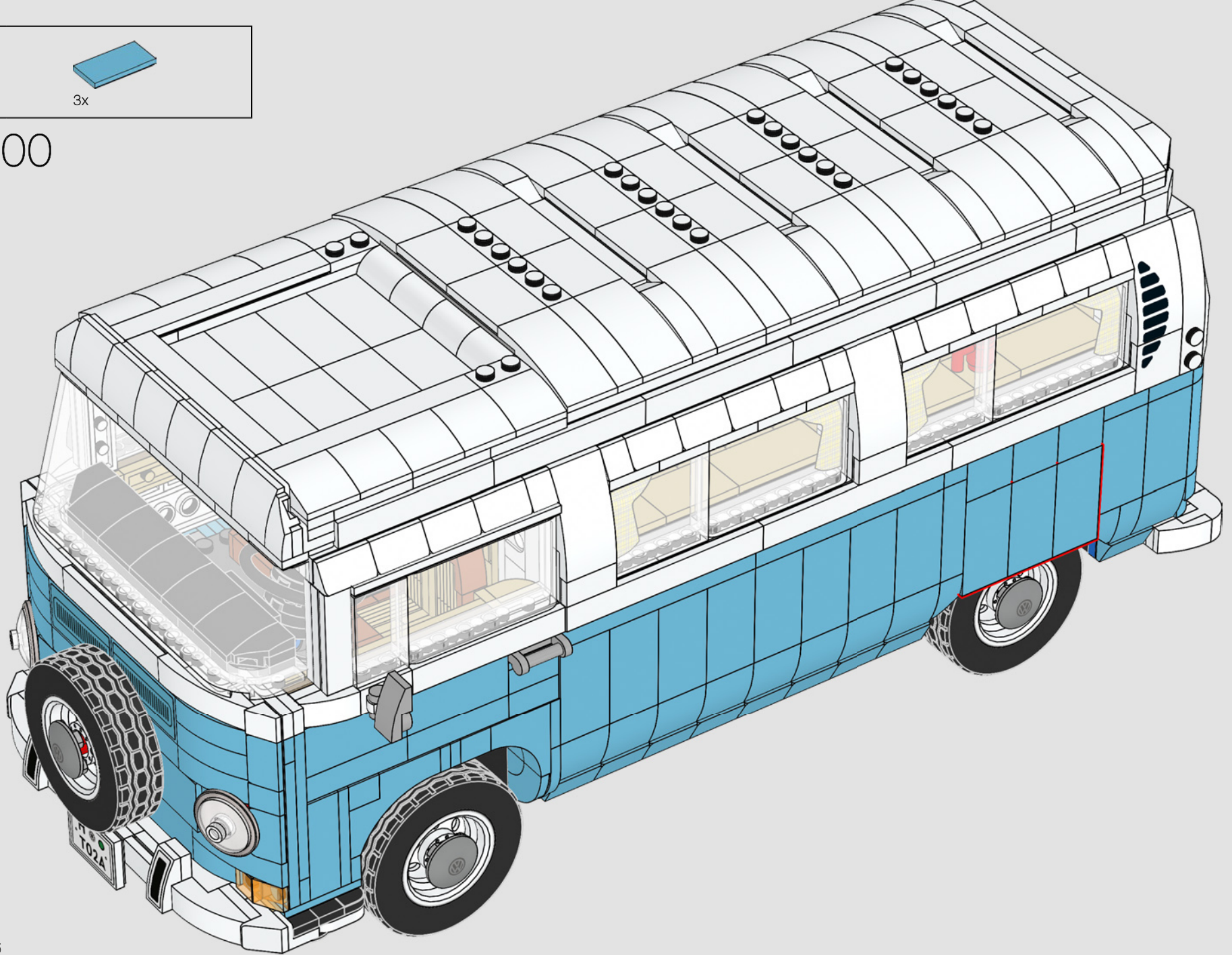

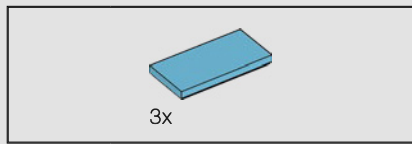

501

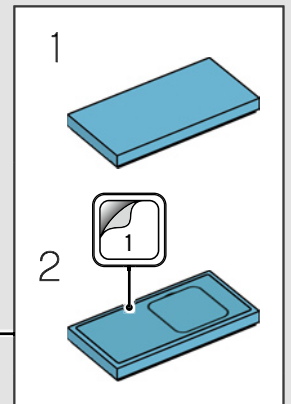
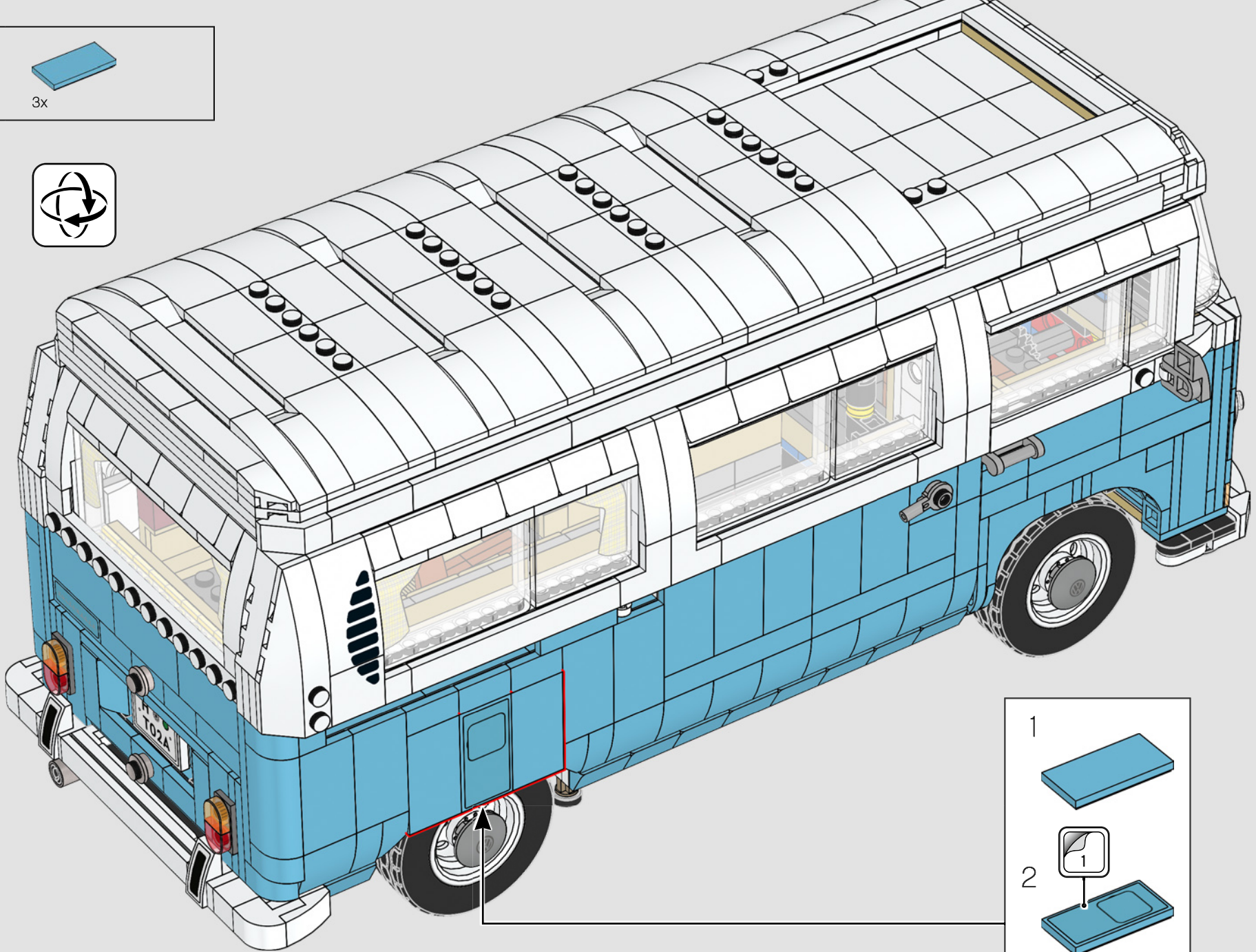

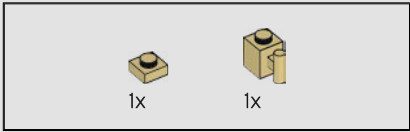
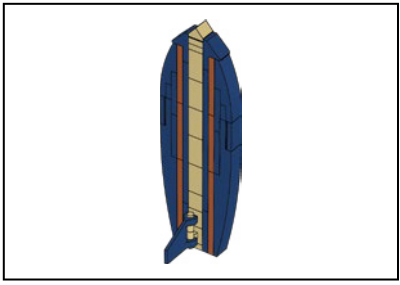

1

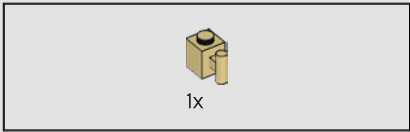
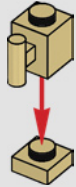

2

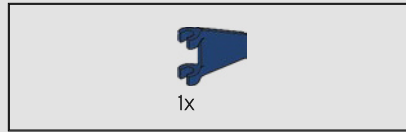
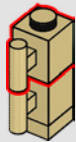

3

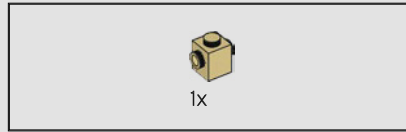
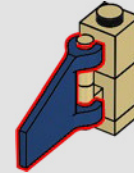

4

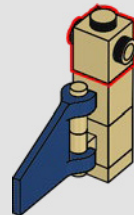

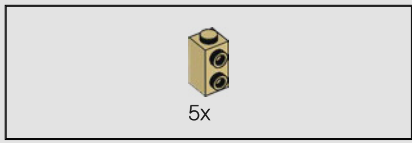

5

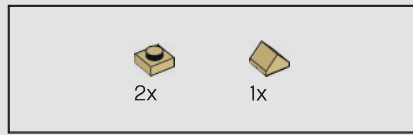
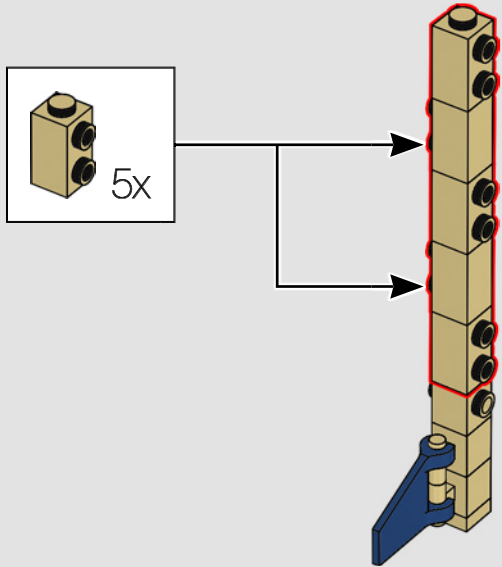

6

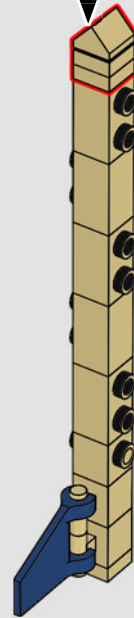
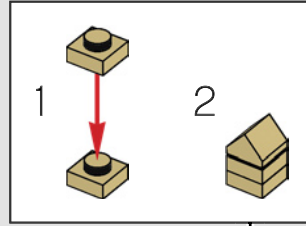

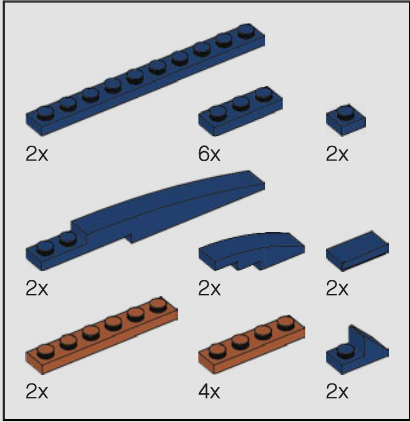
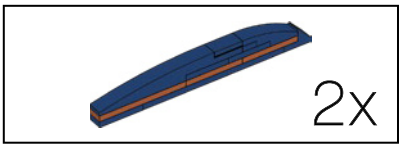

7

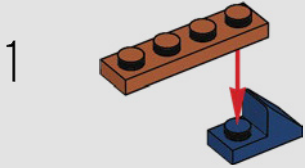

2

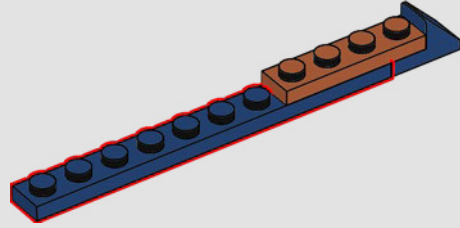

3

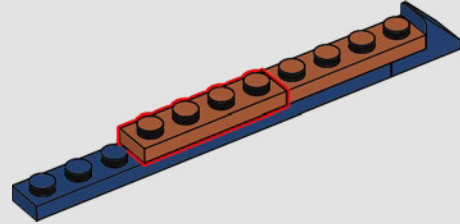

4

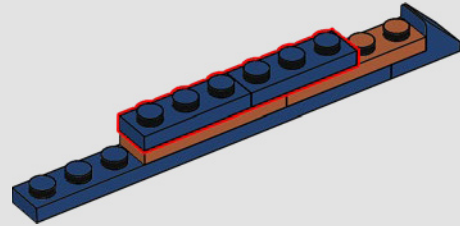

5

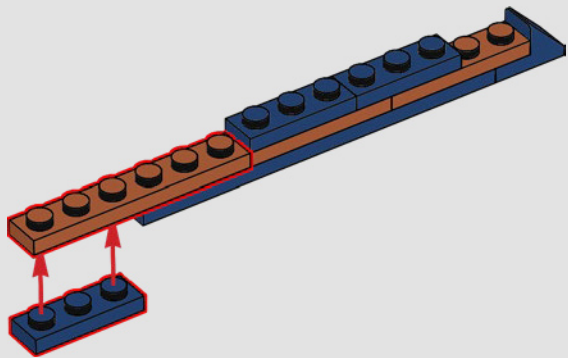

6

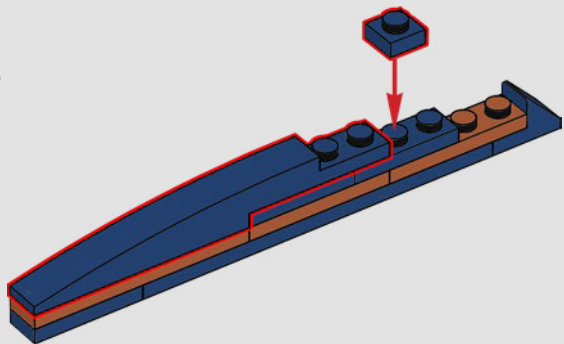

7

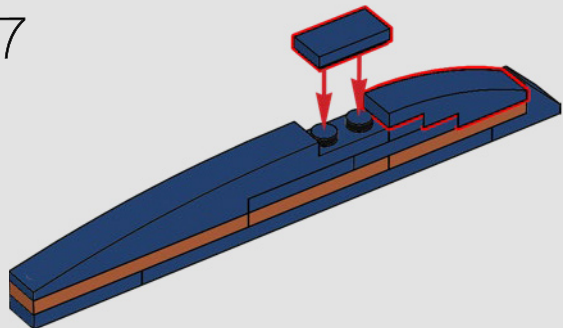

2x

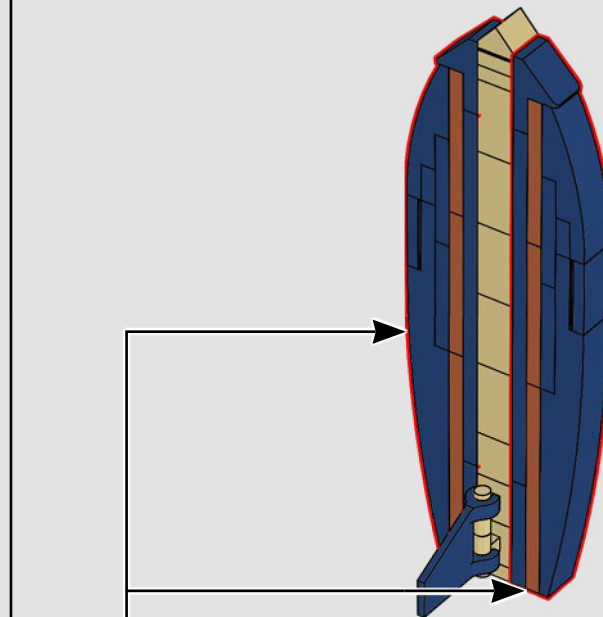

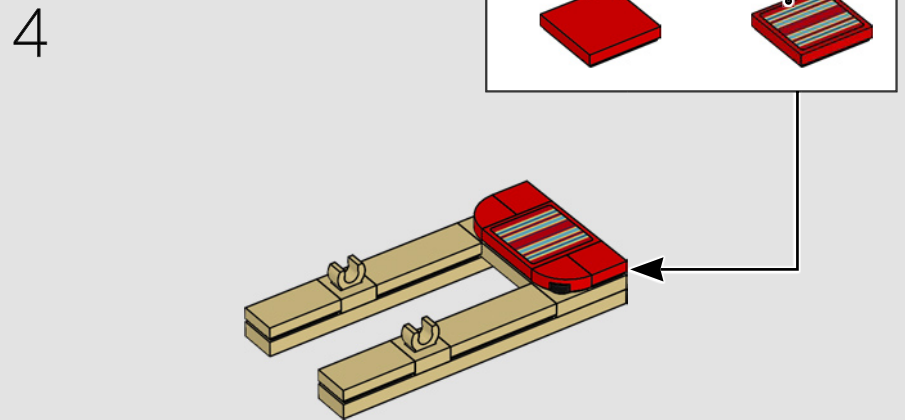
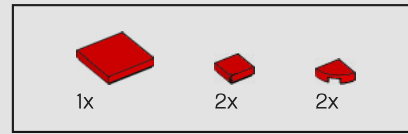
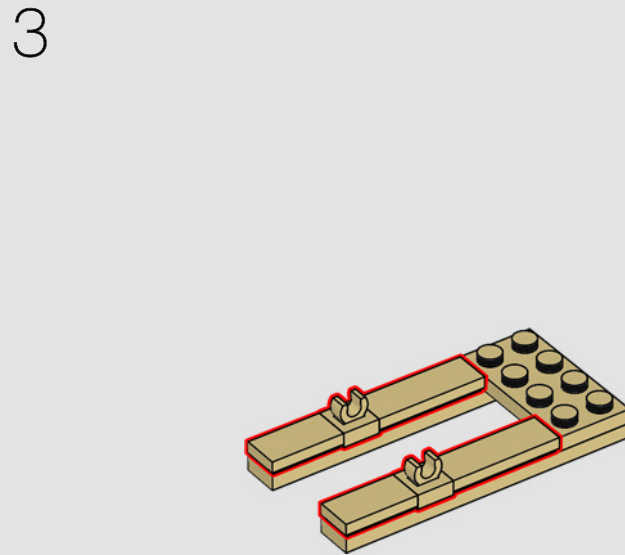
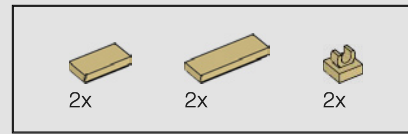
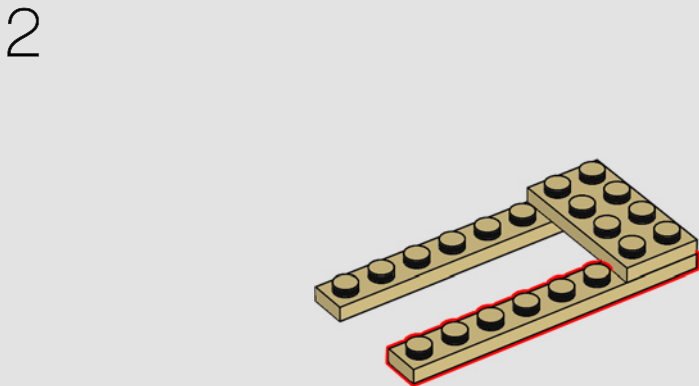
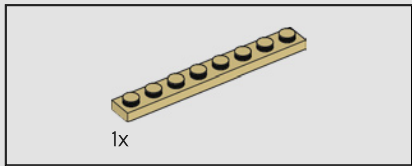
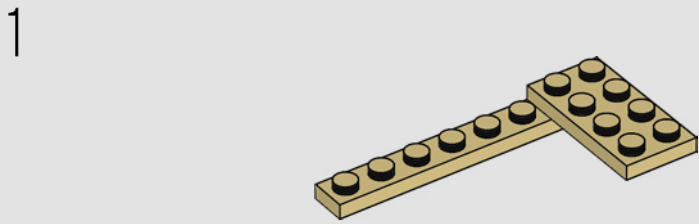
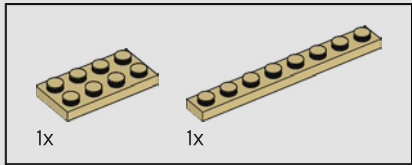
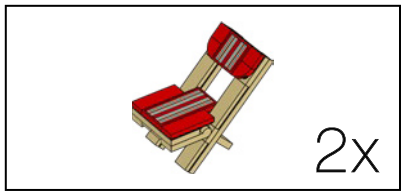

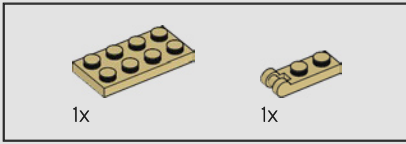
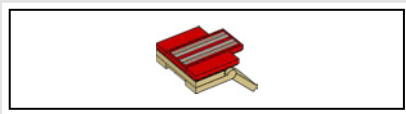

5

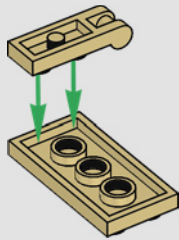

6

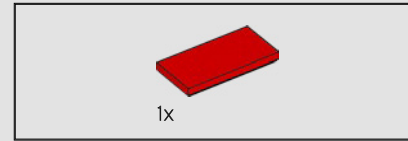
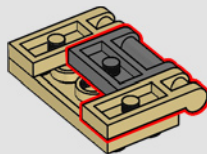

7

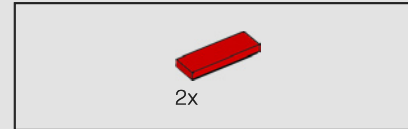
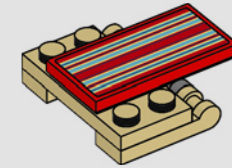
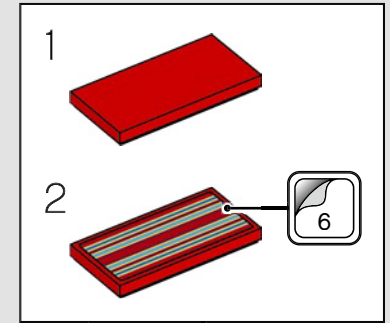
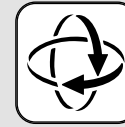

8

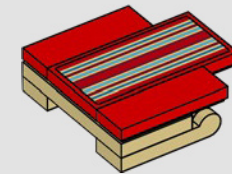



2x

9

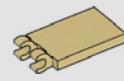
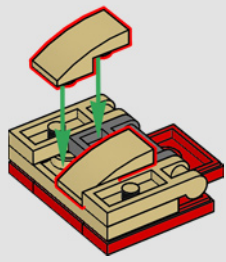

1x

10

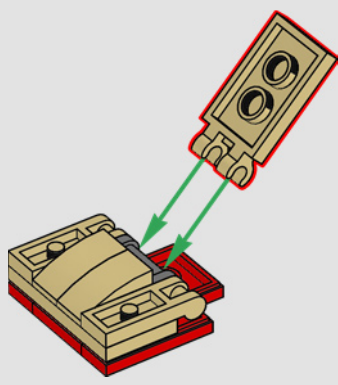

11

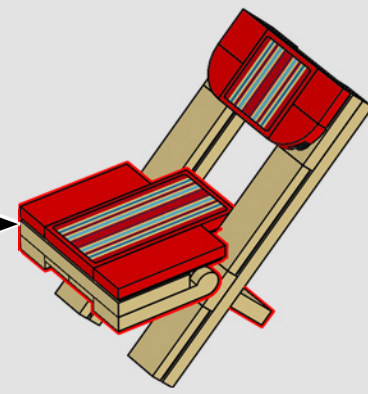
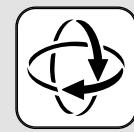

2x

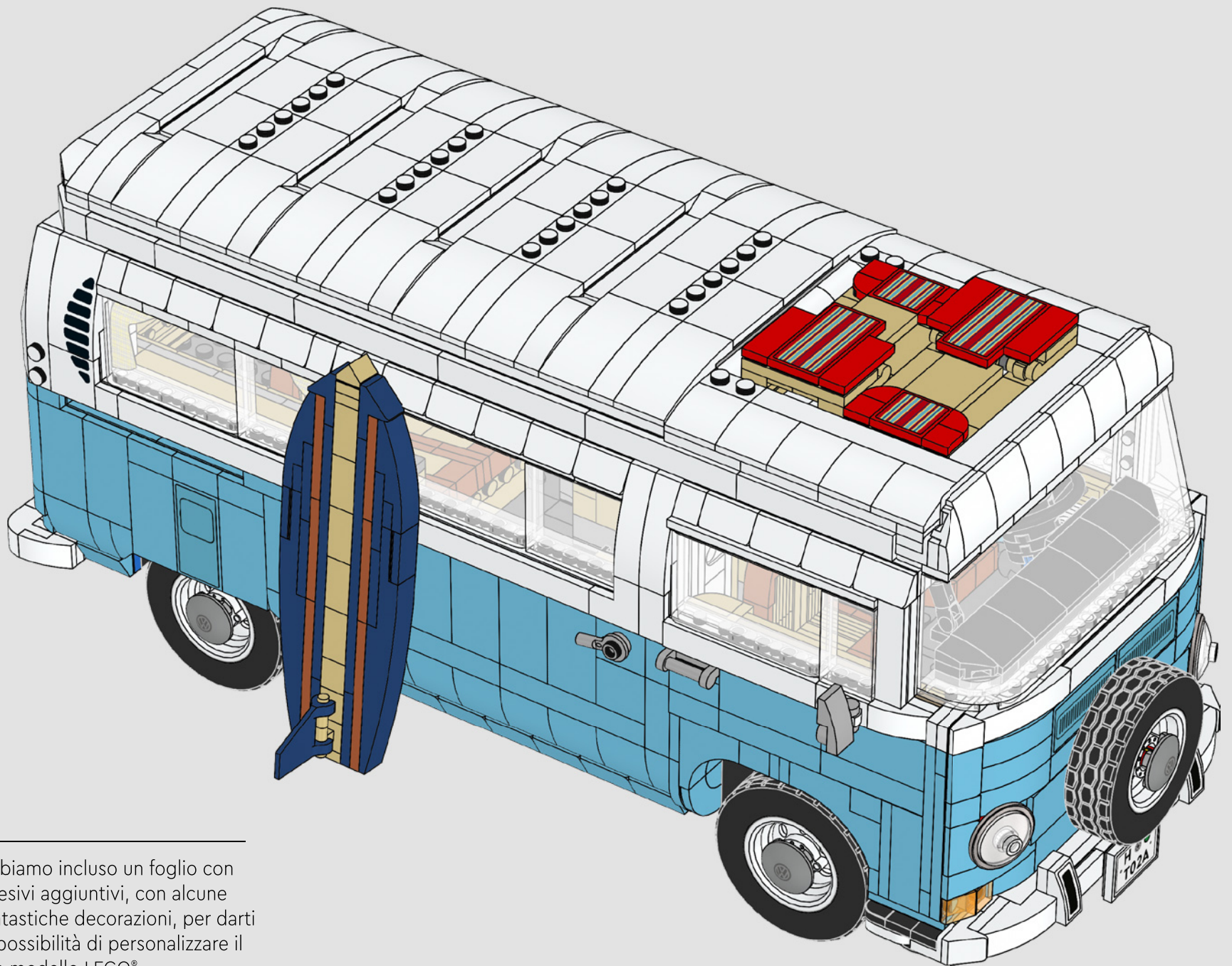

Abbiamo incluso un foglio con adesivi aggiuntivi, con alcune fantastiche decorazioni, per darti la possibilità di personalizzare il tuo modello LEGO®.



FEEDBACK AND WIN



FEEDBACK AND WIN

Your feedback will help shape the future development of this product series.

Please visit:

FEEDBACK UND GEWINNEN

Dein Feedback trägt zur Weiterentwicklung dieser Produktreihe bei.

Geh auf:

COMMENTEZ ET GAGNEZ

Vos commentaires nous aideront à concevoir les futurs produits de cette gamme.

Rendez-vous sur :

COMENTA Y GANA

Tu opinión nos ayudará a dar forma al desarrollo de esta serie de productos en el futuro.

Visita:

反馈有奖

您的反馈将有助于我们在今后改进本系列产品。

请访问：

[LEGO.com/productfeedback](https://www.lego.com/productfeedback)

By completing, you will automatically enter a drawing to win a LEGO® set.

Terms & Conditions apply.

Durch Ausfüllen nimmst du automatisch an der Verlosung eines LEGO® Preises teil.

Es gelten die Teilnahmebedingungen.

En envoyant vos commentaires, vous serez automatiquement inscrit(e) à un tirage au sort qui vous permettra de remporter un prix LEGO®.

Offre soumise à conditions.

Al contestar, participarás automáticamente en el sorteo y podrás ganar un set LEGO®.

Sujeto a Términos y Condiciones.

完成我们的反馈调查，即可自动进入抽奖环节，赢取乐高®套装。

适用《条款和条件》。

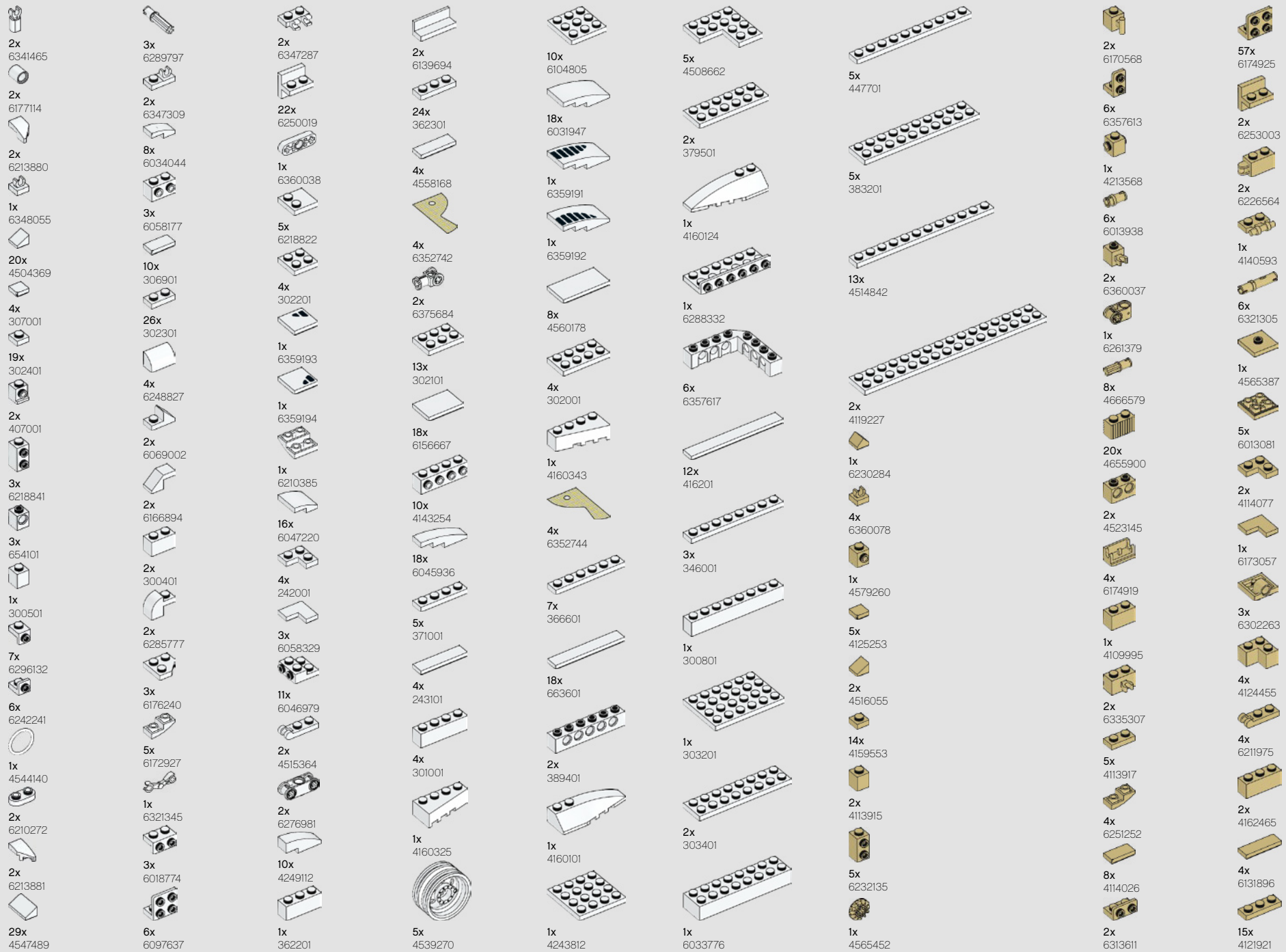

6x
6328182

1x
6211966

2x
6364436

8x
4118790

4x
6175367

2x
4159739

4x
4550324

2x
6019724

8x
4113233

3x
6195544

2x
6311104

5x
4114309

5x
6122047

328

3x
4124067

1x
4112982

3x
4157277

3x
4113993

1x
4181134

2x
6288331

17x
4114324

3x
4544139

1x
4161443

2x
4113988

2x
6037398

5x
4143409

2x
4166138

2x
4509897

5x
6156462

1x
4624185

1x
4295313

7x
6271820

4x
6170390

2x
6348058

4x
307021

2x
6187620

5x
6360104

1x
389921

6x
4142865

1x
6330198

2x
370021

3x
6261351

4x
6135130

1x
4207715

7x
6273712

2x
306821

1x
6209519

13x
6061711

4x
4533742

4x
6118830

1x
6331864

6x
6330205

1x
243121

2x
370121

4x
371021

2x
4560179

1x
4143154

10x
6029952

1x
6144791

1x
6130004

2x
370221

1x
303221

3x
4645733

4x
383221

1x
611221

2x
6284575

1x
306223

1x
6282145

16x
4143005

2x
6344218

7x
403223

7x
4206482

1x
6167491

1x
614323

4x
306923

1x
393723

1x
6179330

1x
6224999

2x
6344176

23x
6299413

4x
302223

2x
242023

4x
243123

3x
302023

1x
4142134

3x
6033353

1x
379523

4x
4506043

4x
303423

1x
6057905

2x
447723

13x
614124

5x
6271167

14x
407024

1x
4114584

1x
6329889

2x
4519010

22x
302324

1x
6247387

1x
302224

2x
6130007

2x
6375678

2x
6072627

4x
362224

3x
4164073

5x
371024

1x
6130008

2x
6115616

1x
6079138

1x 6088550
1x 6321194
2x 6284070
1x 4529236
3x 6168646
2x 6256435
2x 6121485
1x 6335388
5x 302426
1x 6181720
2x 6172383
6x 4558954
1x 6344752
1x 4180536
1x 6196548
1x 6181713
1x 4180508

80x 6279875
3x 4278359
2x 6143850
2x 403226
1x 6271535
1x 6070695
1x 6195325
11x 6147050
2x 6047276
7x 300426
8x 4144023
2x 6174243
2x 6138173
2x 6156991
1x 4113241
3x 235726

6x 302326
2x 306926
2x 6173119
1x 6178922
2x 4107761
1x 6346535
2x 6278276
5x 6211476
4x 6192346
5x 6053077
2x 242026
4x 4124096
2x 6089119
8x 6199908
1x 362226
1x 4558170

3x 6052126
3x 6265644
2x 6116604
2x 302126
2x 370526
1x 6172966
1x 4613153
3x 4159550
1x 6299938
2x 4560182
3x 6194233
1x 302026
4x 300126
2x 370626

4

6

5x 6319995
2x 379526
1x 6318582
1x 346026
2x 273026
3x 4188143
2x 6313123
3x 303428
16x 6254484
6x 6339914
1x 6345166
4x 4614158
6x 6186009

14x 4570877
2x 6340118
10x 6186007
4x 6074892
2x 6253418
1x 6301284
2x 6264033
1x 6246890
2x 6245306
2x 6211814
4x 6245269
6x 6254638
1x 6288588

1x 6319998
1x 6270534
1x 4212454
12x 6302741
2x 6334042
3x 6278442
1x 6284582
1x 4524929
1x 6223631
1x 6147052
3x 6265128
1x 4188771
8x 6347790



2x
6271832

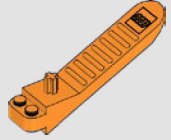

1x
6240515

1x
6352682



1x
4173332



2x
4184108



2x
4528488



2x
6186683



1x
4529551



6x
4177735



2x
6186974



2x
6042956



2x
6251378



2x
6200663

330



2x
6135494



1x
6159763



1x
6341975



1x
6357616



1x
6278550



1x
6258323



1x
4539099



1x
4539114



1x
6337786



1x
4539060



1x
4650865



2x
4541528



1x
6357747

2x
6249116

3

5



1x
6326748



2x
6347715



3x
4211412



3x
6258831



1x
6250597



1x
4211415



2x
4211535



1x
6267495



7x
4211375



4x
6227897



2x
6225246



3x
6151349



2x
4550325



5x
6359195



2x
6123815



4x
6144138



2x
6028813



1x
4211470



9x
4211398



5x
6168633



19x
4211440



1x
6117967



3x
6117967



2x
4654582



2x
4244627



4x
4211397



2x
6319336



6x
6212077



1x
6163990



6x
6045988



1x
4211815



2x
4515369



2x
4552348



2x
6282158



1x
6273212



1x
6335279



1x
6329117



9x
6251044



9x
4211428

3



5x
6168615



1x
6259270



5x
4211396



1x
4610112



14x
6347992



1x
4211394



1x
4211445



4x
6230229



6x
6015347



2x
6331428



6x
6247352



1x
6079461



2x
4211438



3x
4211393



1x
4211640

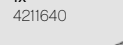

6x
4211481



2x
4211442



1x
4211392



4x
4211406



3x
4251149



1x
4211374

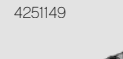

4x
4211407

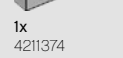

4x
4211407



2x
4611705

11

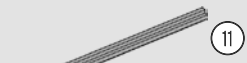

1x
6178172



1x
4514846



1x
4211522

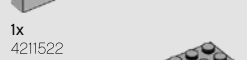

3x
4211360



3x
6023978



2x
4211401



4x
4211443

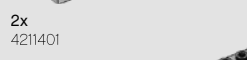

10x
6300320



1x
6031821

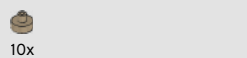

3x
6156492

11

32

2x 6245265
 2x 6254252
 2x 6322904
 4x 4633691
 1x 6161155
 2x 6076677
 2x 6132264
 4x 6074793
 7x 4619520
 2x 6150307
 2x 6296904
 12x 6097493
 2x 4655243
 2x 6296901
 24x 6097444
 6x 6335566

6x 6071246
 1x 6348142
 5x 6092674
 1x 6126090
 4x 6060857
 17x 6119126
 2x 6357615
 2x 6293739
 2x 6258069
 6x 6035598
 4x 6119107
 8x 6097492
 4x 6036238
 2x 6347671
 6x 4624705
 6x 6070757

16x 4649741
 5x 6097419
 4x 6331949
 2x 6056455
 4x 6357619
 3x 6357618
 2x 6357620
 38x 6097042
 5x 4655256
 2x 6345200
 2x 6185309
 6x 4625036
 2x 6357614

2x 6141594
 5x 6078339
 4x 6364352
 2x 6230582
 1x 6259768
 1x 6317938
 2x 6271752
 2x 4504378
 6x 4211044
 2x 6276870
 2x 6221607
 3x 6115080
 3x 6135014
 2x 6265093
 3x 4211111

2x 4516546
 1x 4211052
 2x 4211063
 2x 6214341
 2x 6000606
 2x 6359227
 2x 6146321
 4x 6352600
 1x 6126083
 2x 4211094
 3x 6284702
 4x 4211055
 9x 4210751
 4x 6187008
 2x 4211043
 5x 4211001

3x 6083620
 2x 6092649
 1x 6008715
 11x 4560184
 2x 4211065
 2x 4210651
 4x 4539429
 1x 4210728
 2x 6138633
 12x 4210998
 3x 6199511

6x 4257526
 4x 4211061
 3x 4210678
 7x 6133611
 2x 4210963
 3x 4211114
 2x 6000970

4

Customer Service
 Kundenservice
 Service Consommateurs
 Servicio Al Consumidor
 LEGO.com/service or dial
 : 00800 5346 5555
 : 1-800-422-5346



LEGO and the LEGO logo are trademarks of the LEGO Group. ©2021 The LEGO Group.

Trademarks, design patents and copyrights are used with the approval of the owner Volkswagen AG.