

S·P·Q·R·

COLISEO

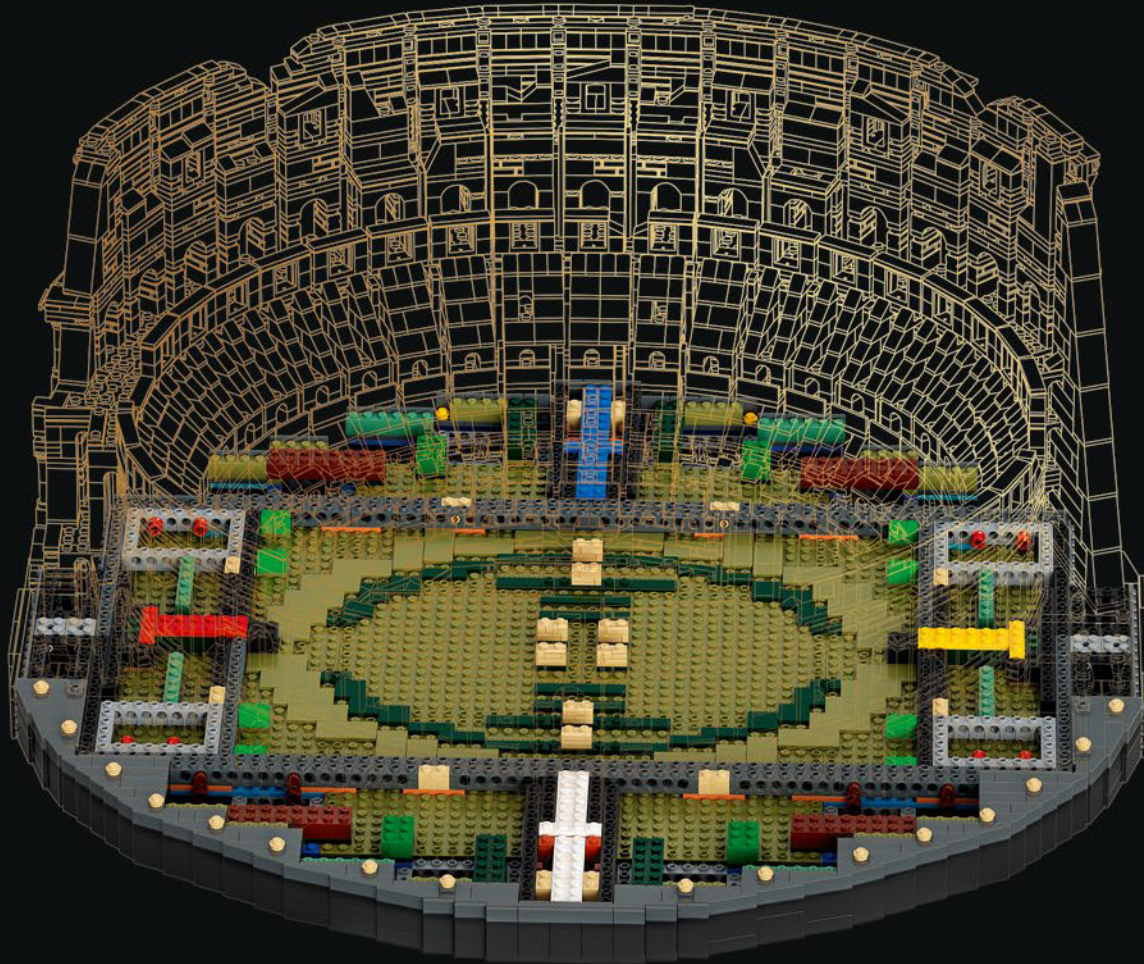

I

TE DAMOS LA BIENVENIDA

Nos complace presentarte nuestra interpretación del famoso Coliseo de Roma. Tanto si te trae recuerdos de una visita a la Ciudad Eterna como si despierta tu interés por la arquitectura clásica o, simplemente, es tu forma de relajarte, esperamos que te proporcione horas de placentera construcción con LEGO®.

Jamie Berard, jefe de diseño

EL COLISEO

El Coliseo se encuentra en el corazón de la capital de Italia y es un inconfundible símbolo de su pasado como parte del Imperio romano. Este impresionante anfiteatro, el más grande que se construyó en aquella época, podía alojar entre 50.000 y 80.000 espectadores. La gente se reunía allí para ver combates entre gladiadores, cacerías de animales e, incluso, recreaciones de famosas batallas navales. Ampliamente considerado como una de las siete maravillas del mundo moderno, es también una de las atracciones turísticas más populares y recibe más de 7 millones de visitantes cada año.





Mientras que los antiguos teatros griegos se construían en las laderas de las montañas, el imponente Coliseo se erige en solitario, sobre el fondo llano de un valle, en el centro de Roma.

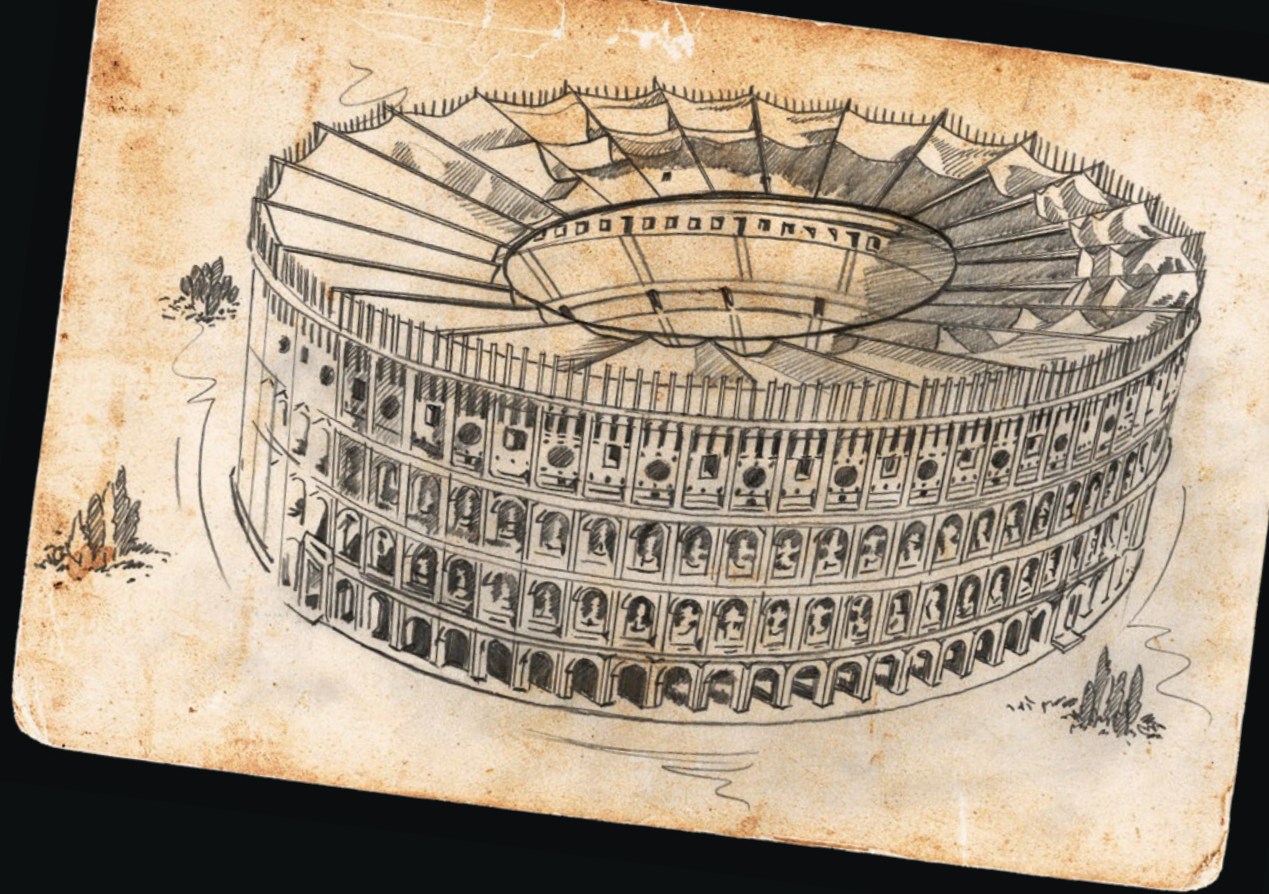

ANFITEATRO

El Coliseo es una estructura elíptica independiente de 189 m de longitud y 156 m de anchura. La arena interior ovalada tiene 87 m de longitud y 55 m de anchura, y está rodeada por un imponente muro de 5 m, por encima del cual se eleva el espectacular graderío. El muro exterior del Coliseo alcanza una altura de 48 m, que aún sería mayor si se consideran los mástiles de madera para sujetar los toldos móviles que se desplegaban en ocasiones mediante complejos mecanismos.



80 entradas a nivel del suelo rodeaban la estructura. Las 4 entradas axiales principales estaban reservadas para el emperador y las élites de la ciudad, y estaban generosamente decoradas.

CONSTRUCCIÓN

La construcción del Coliseo requirió más de 100.000 m³ de travertino (45.000 de los cuales se emplearon en el levantamiento de los muros exteriores). En lugar de usar mortero, las piedras se unieron mediante más de 300 t de abrazaderas de hierro. La fachada exterior de la estructura se compone de 3 niveles, cada uno con 80 imponentes arcadas. En la arena, una plataforma de madera cubierta de tierra ocultaba un elaborado sistema subterráneo denominado *hipogeo*.



HIPOGEO

El hipogeo era una red subterránea de 2 niveles compuesta de túneles y jaulas que se agregó después de la construcción original del Coliseo. Era donde se alojaban los gladiadores y los animales antes de los combates. Su construcción significó el fin de las espectaculares recreaciones de batallas navales, pues ya no era posible inundar la arena.



[LEGO.com/brickseparator](https://www.lego.com/brickseparator)

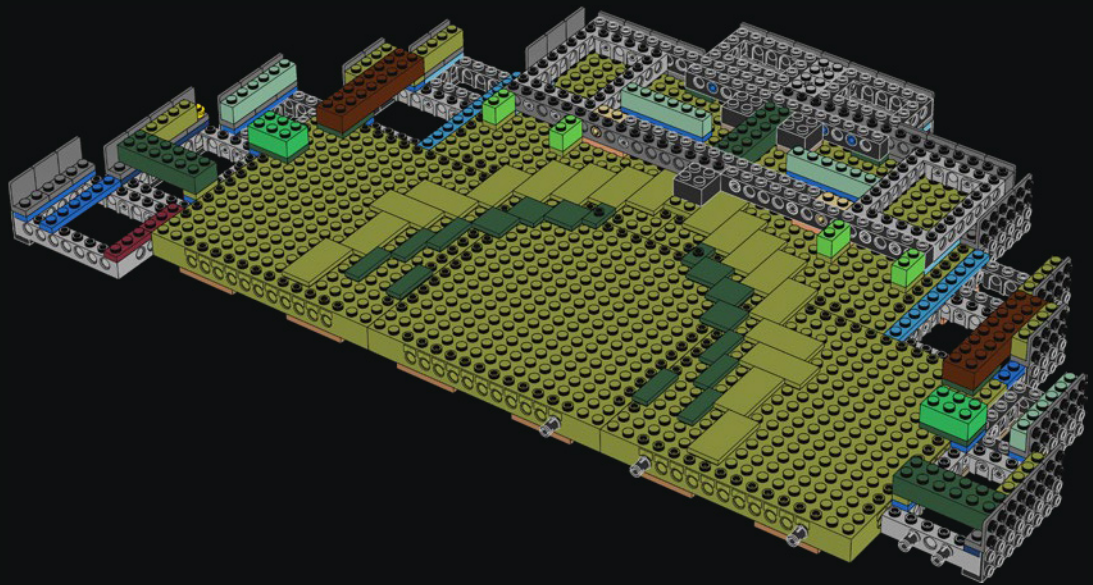

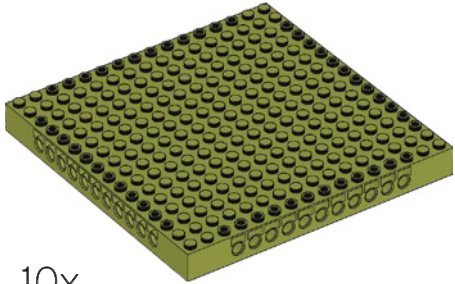

10x

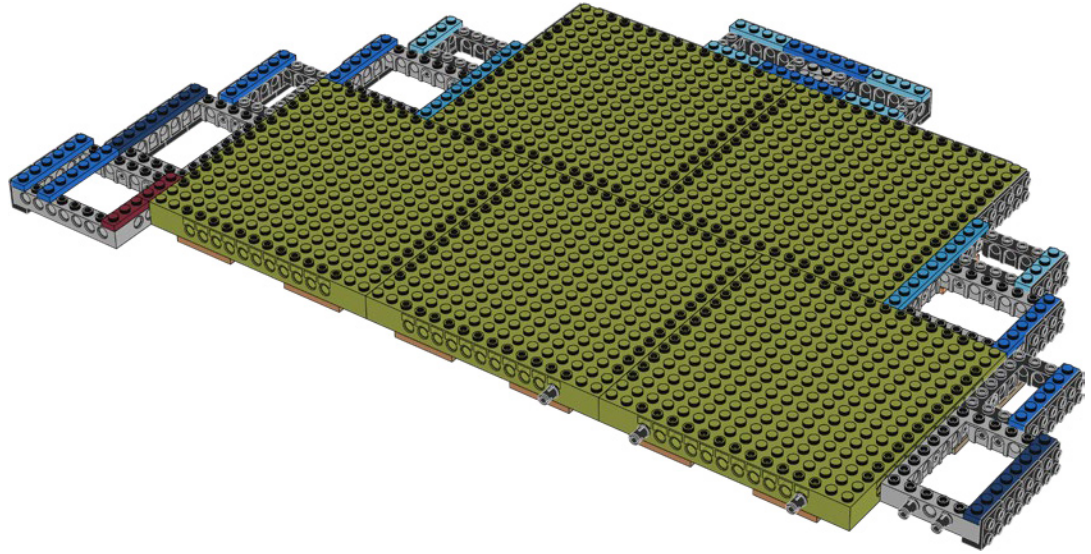
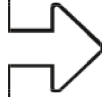

2x



1

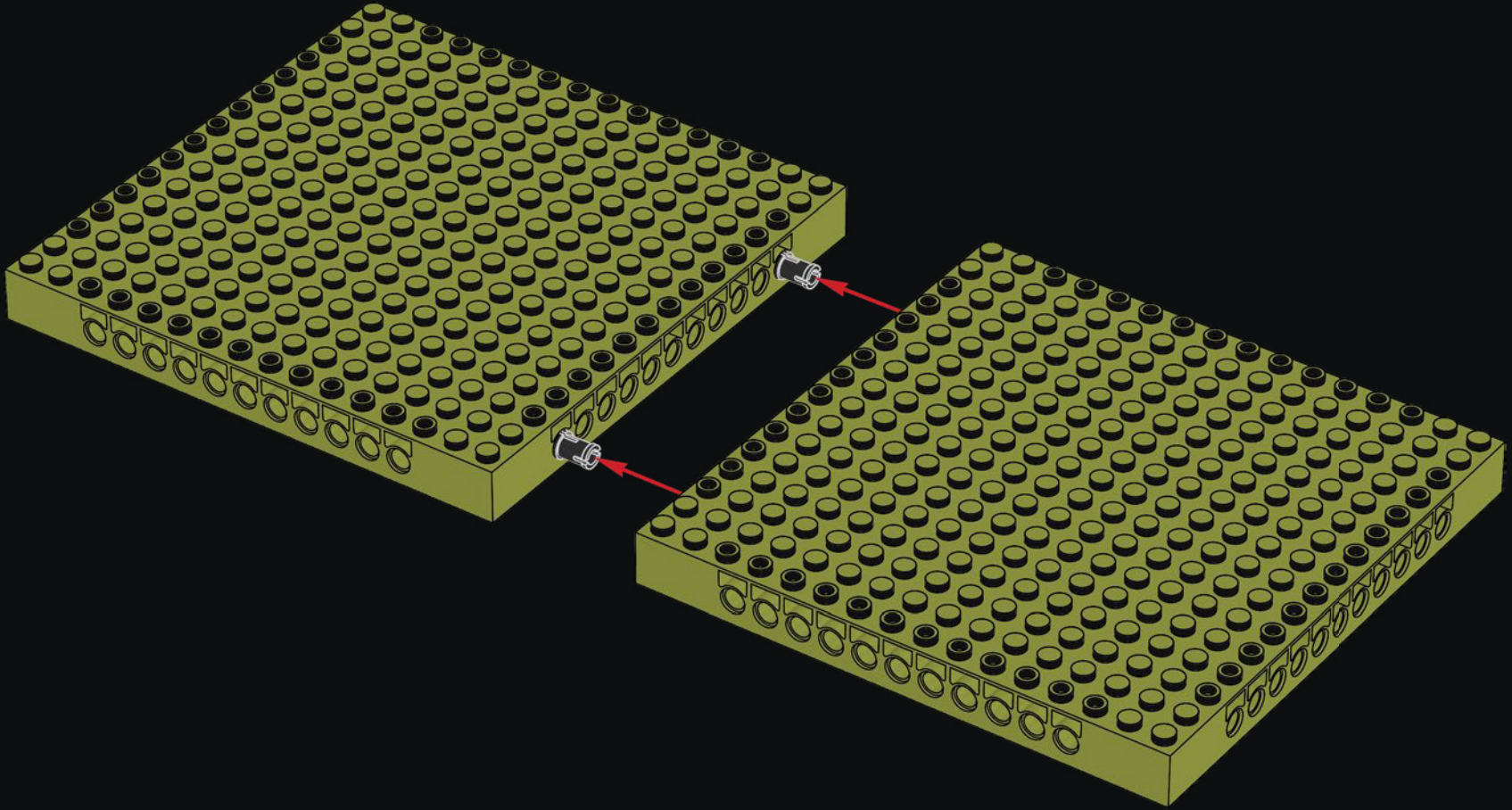

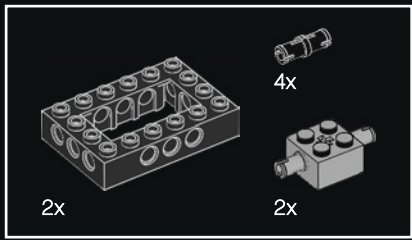

2

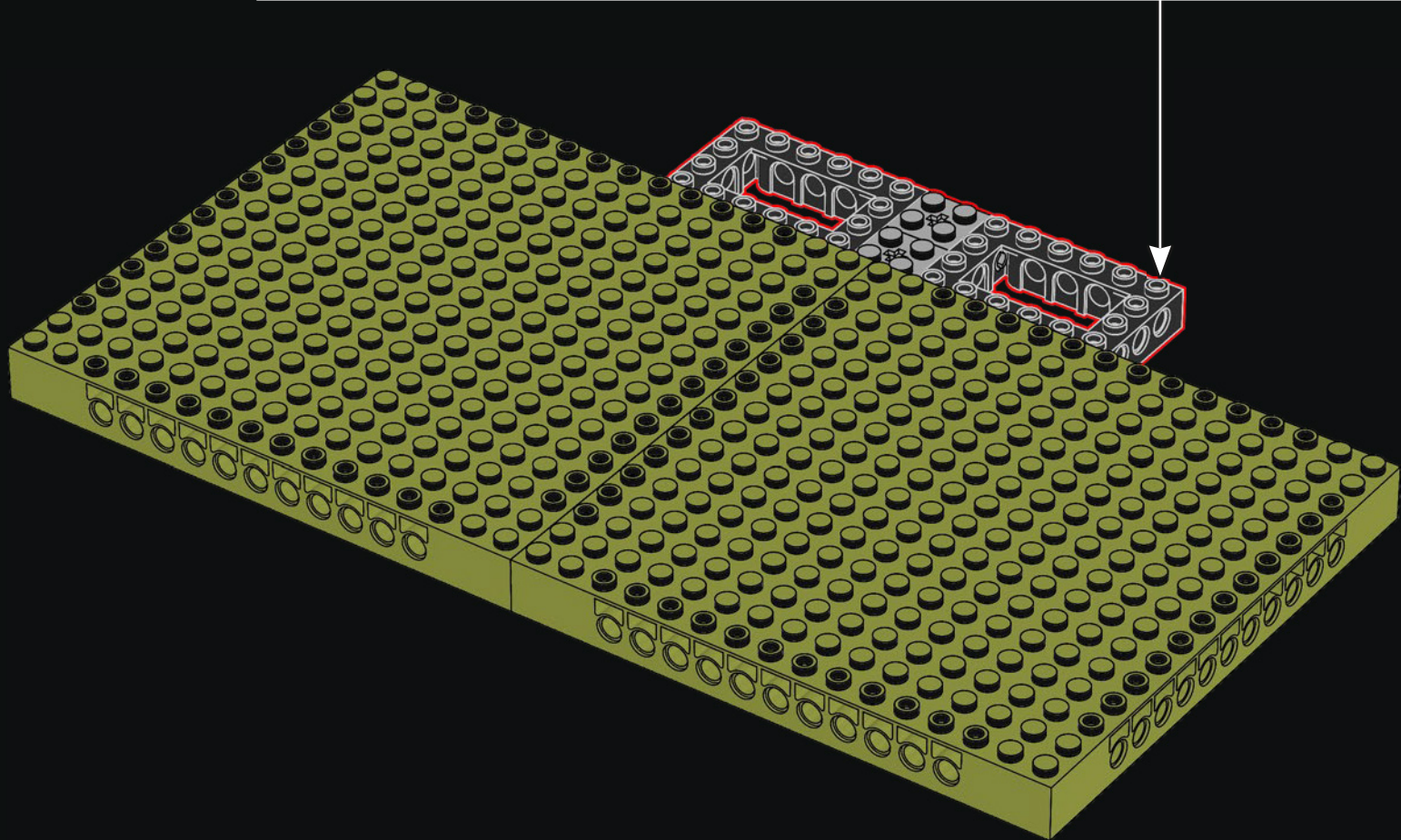
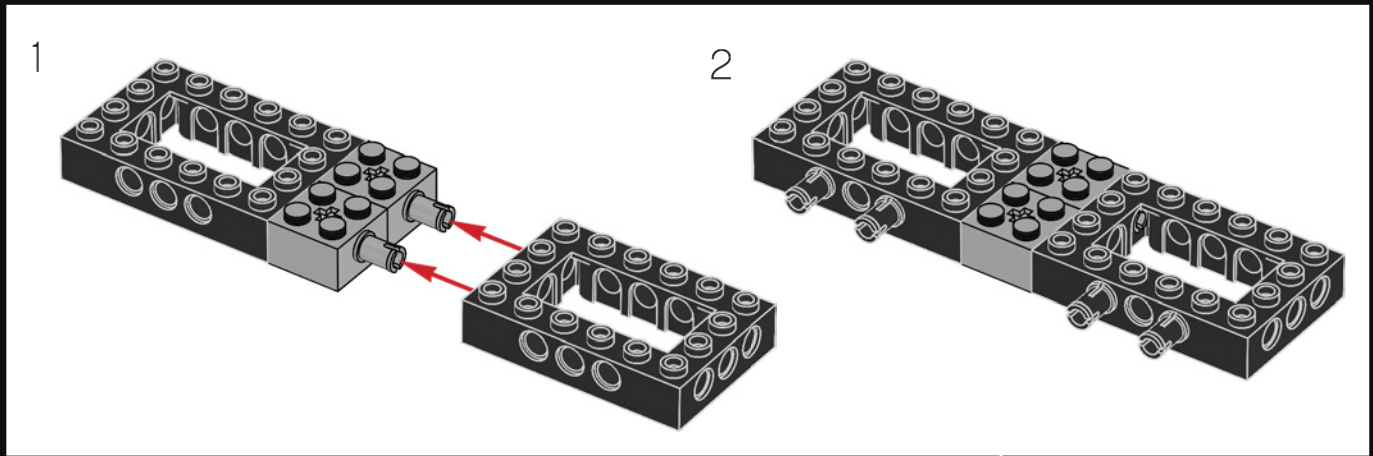



3

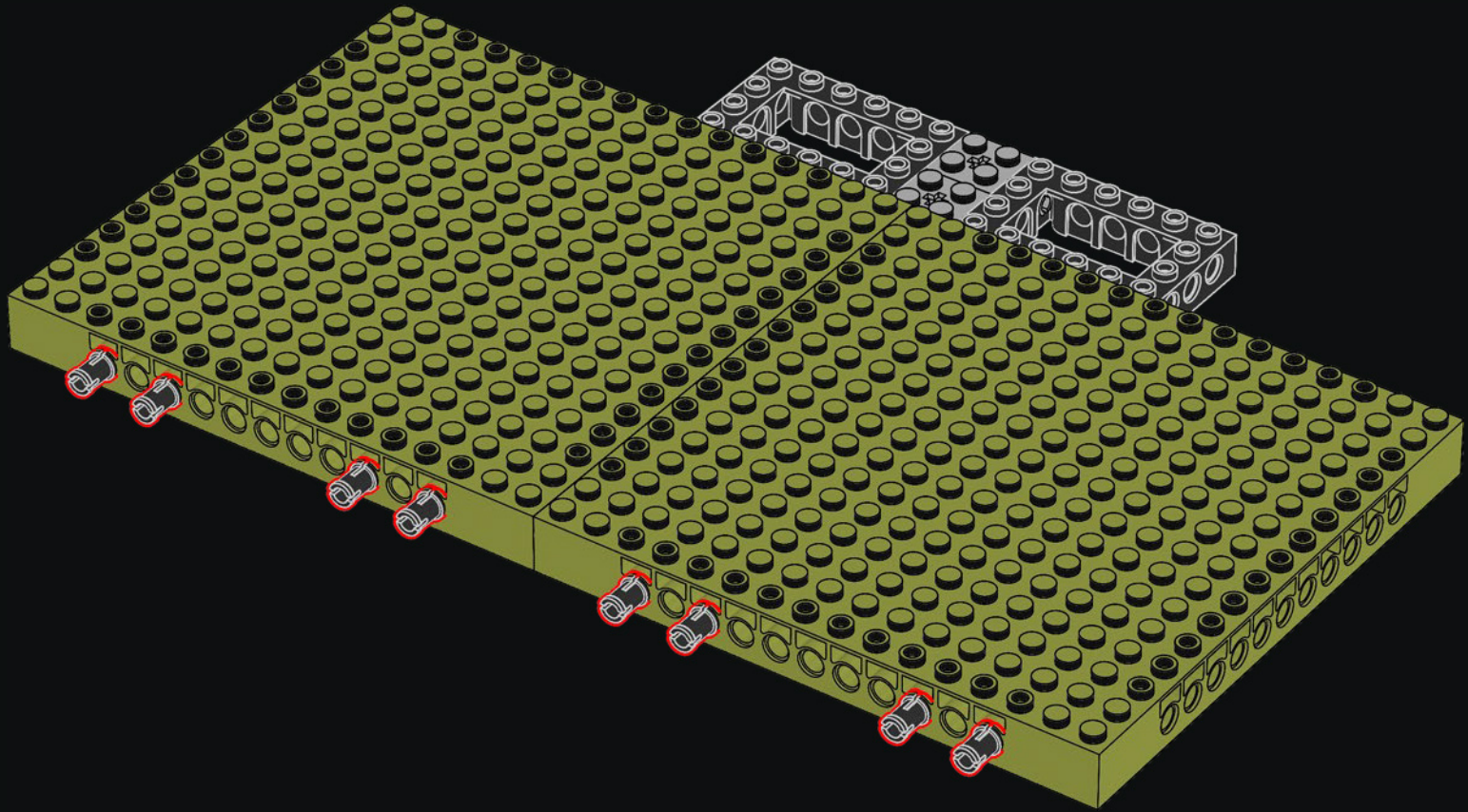

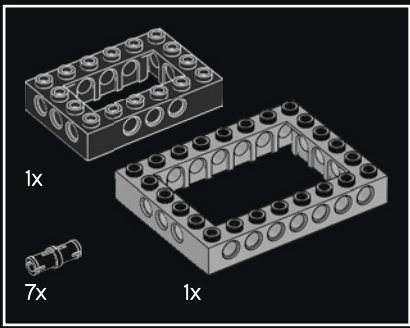

4

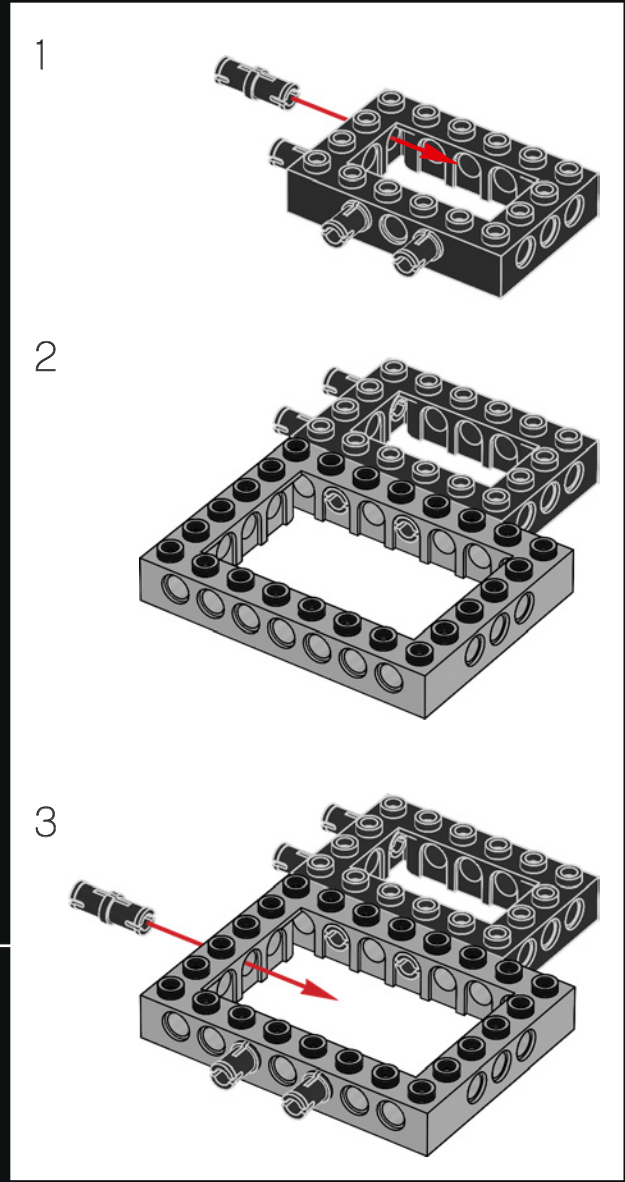
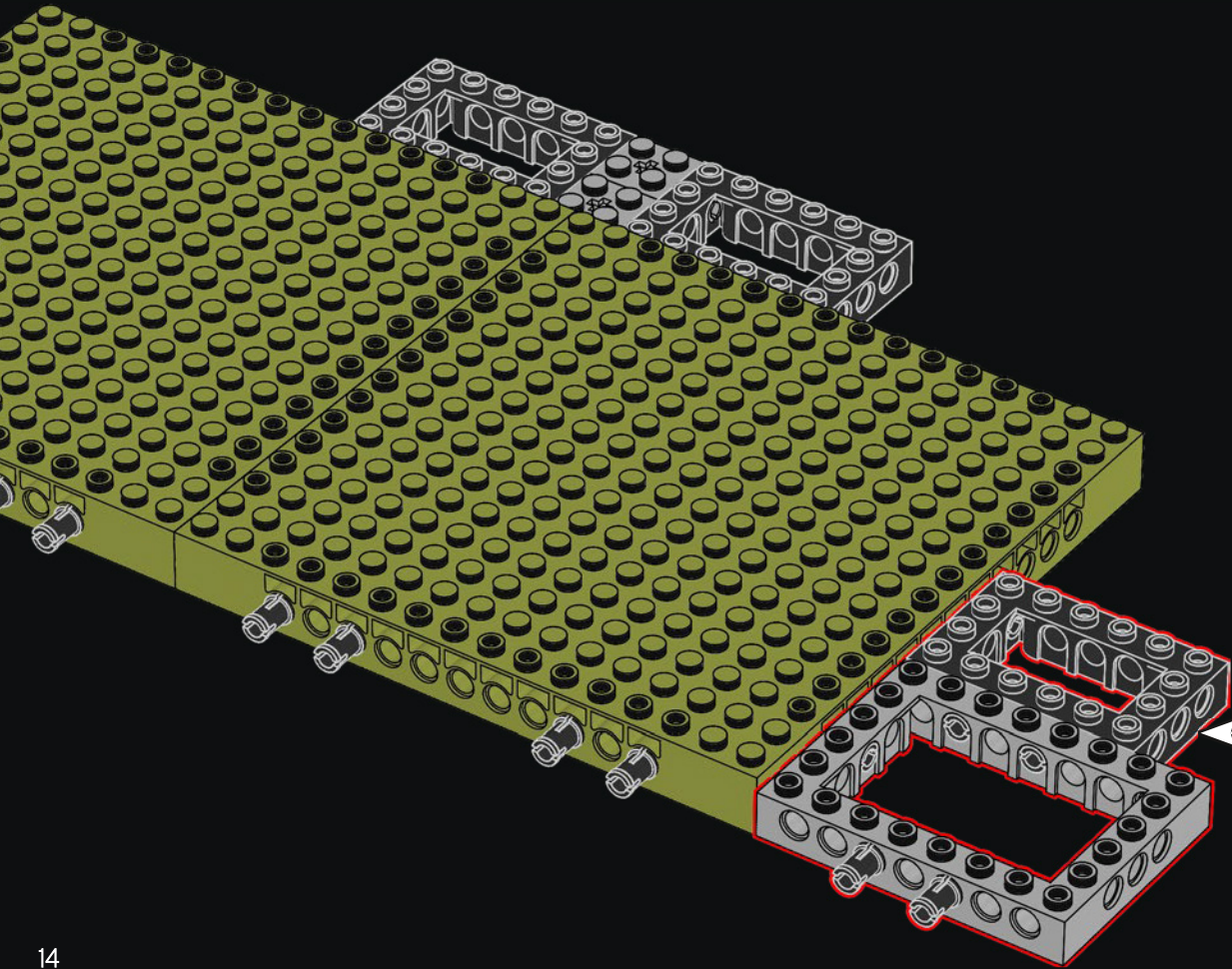

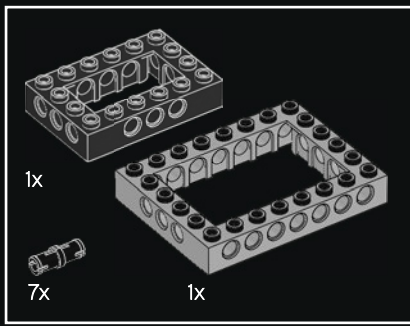

5

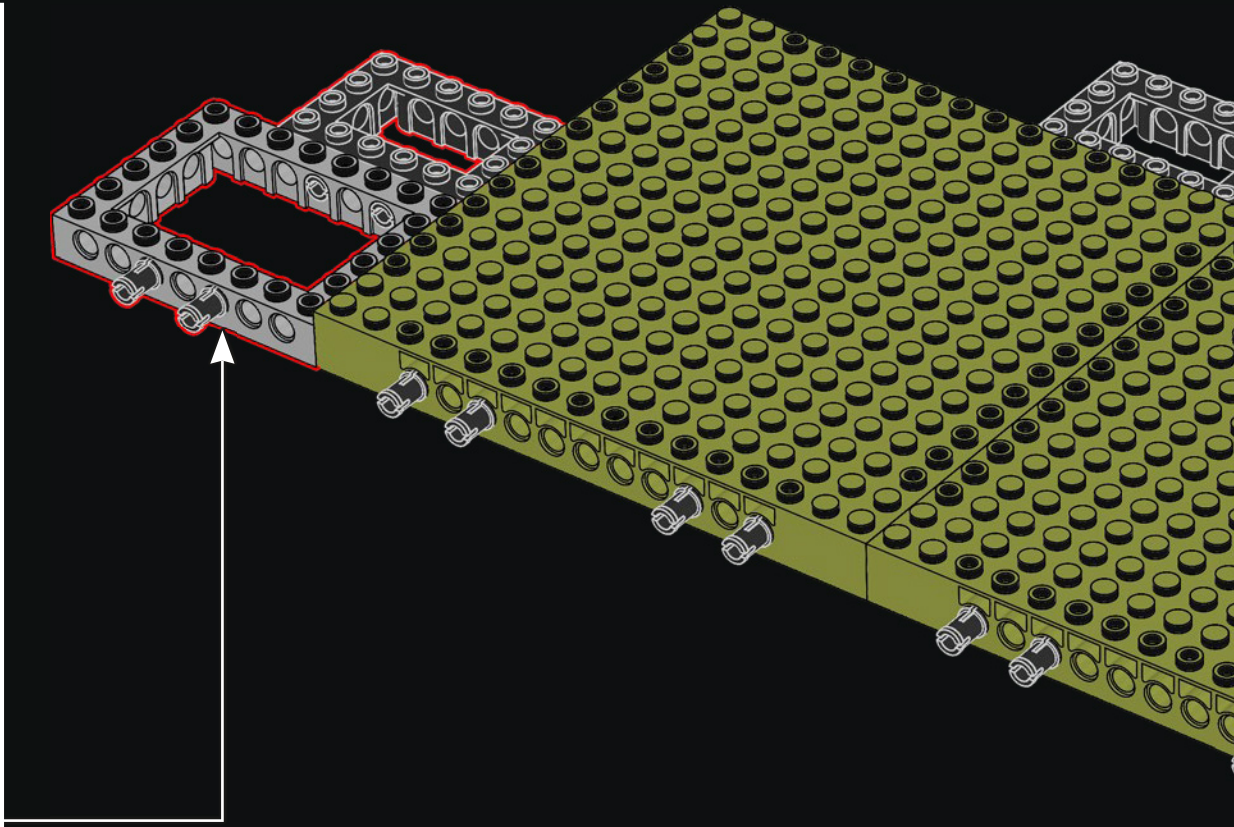
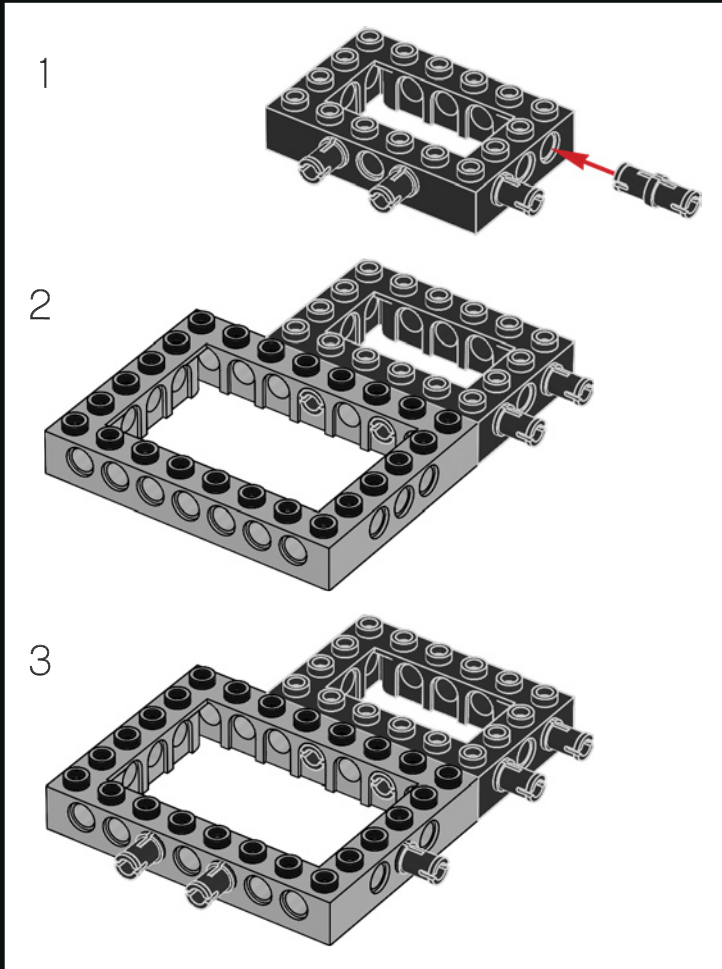



2x

6

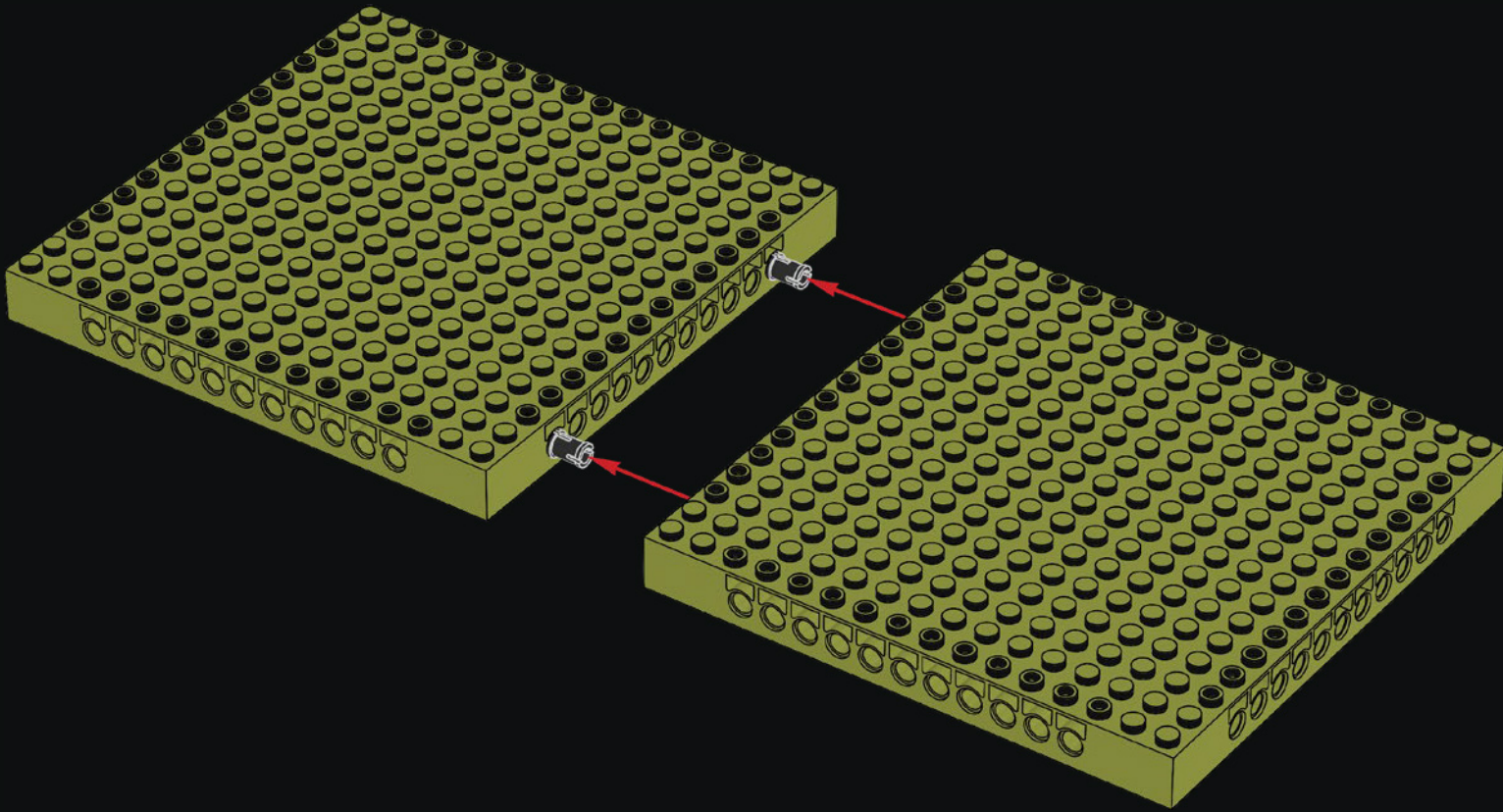



7

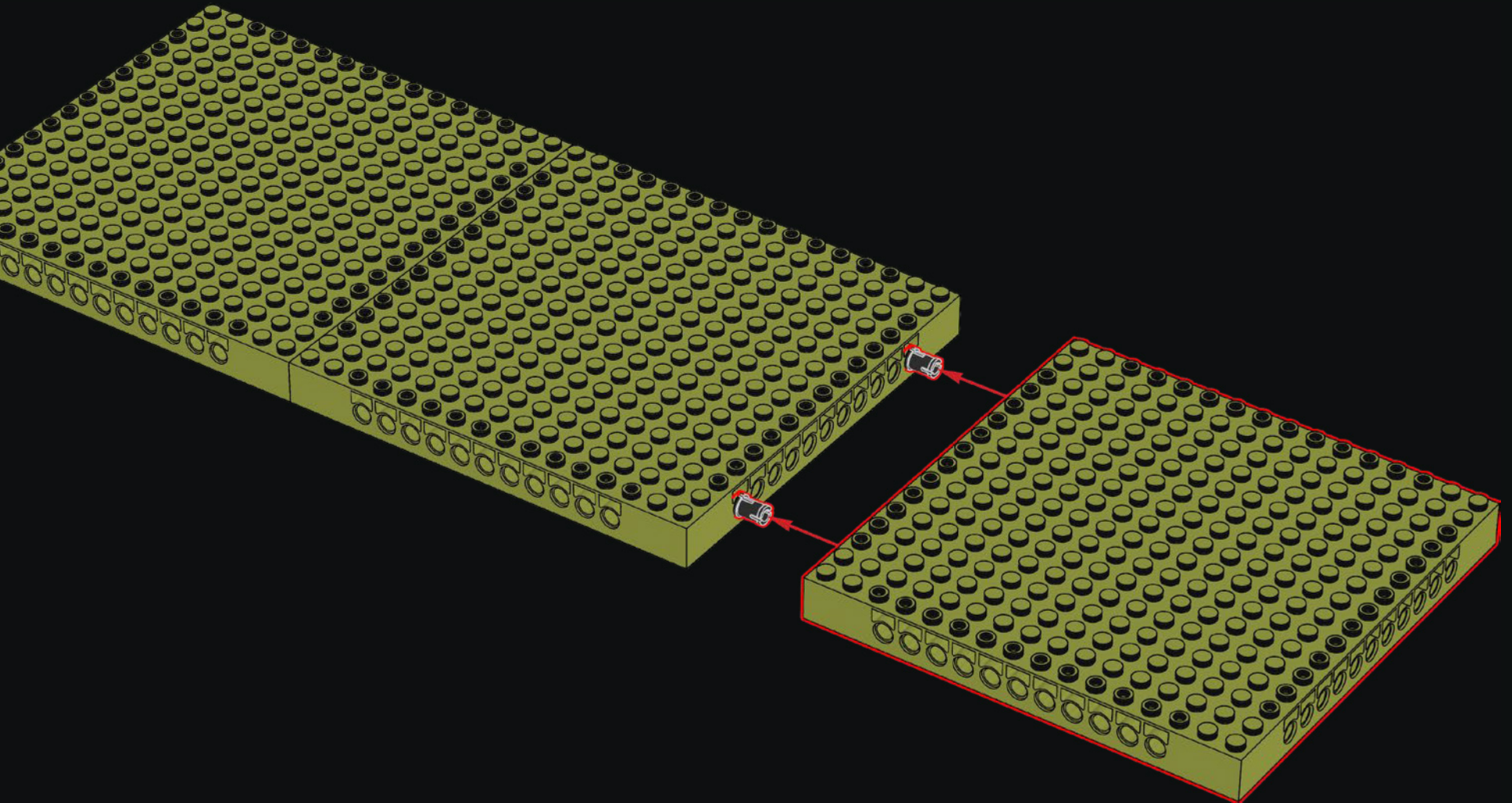

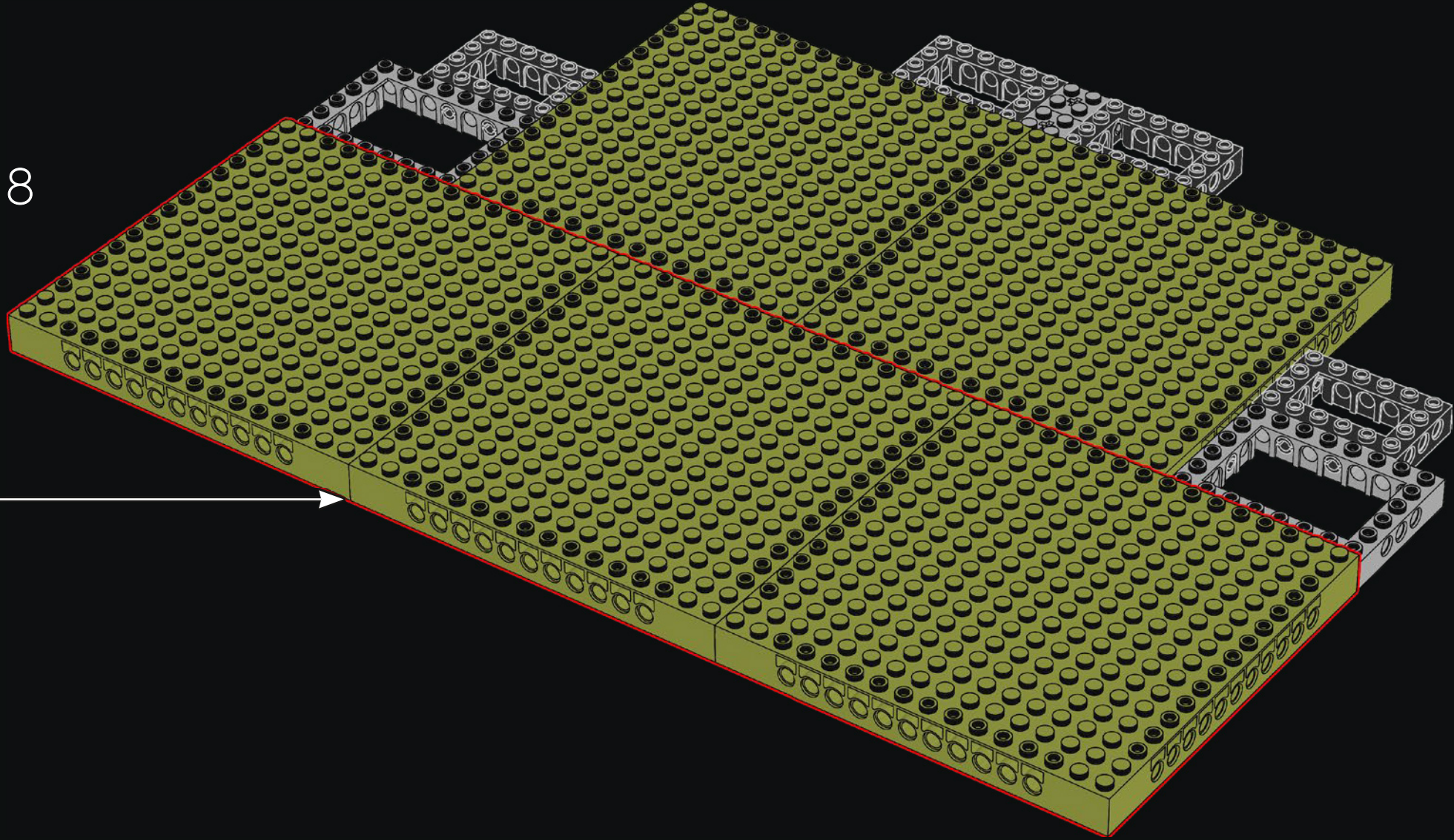

8

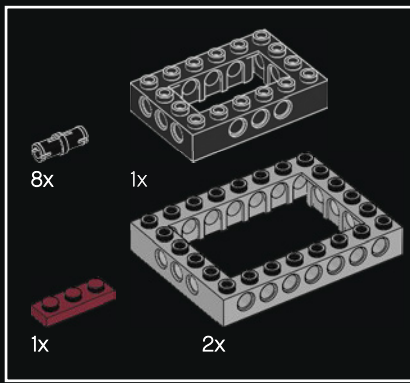

9

1

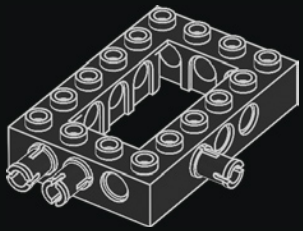

2

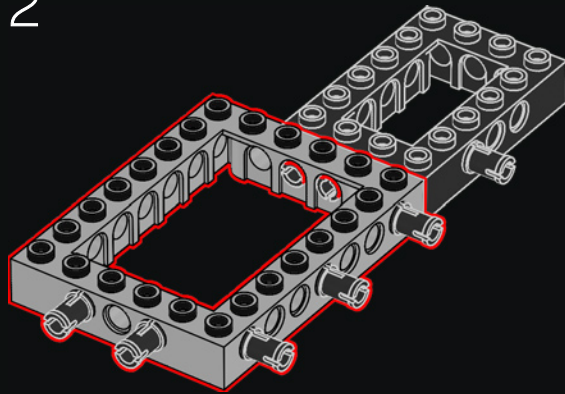

3

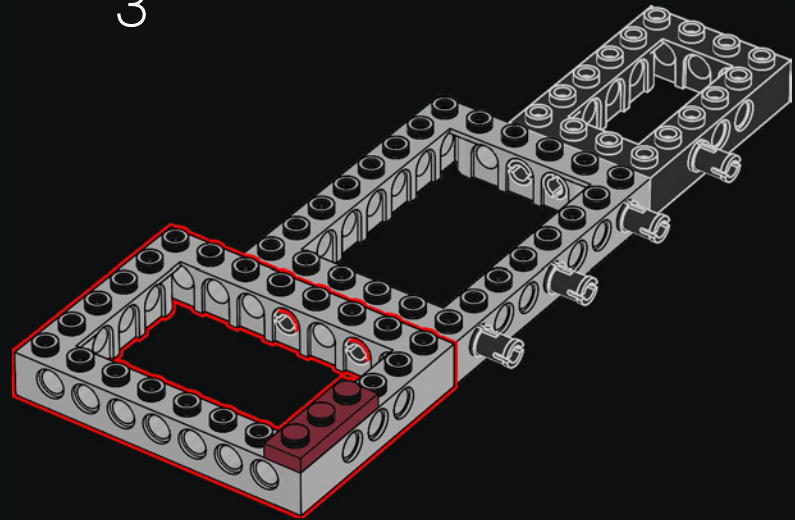

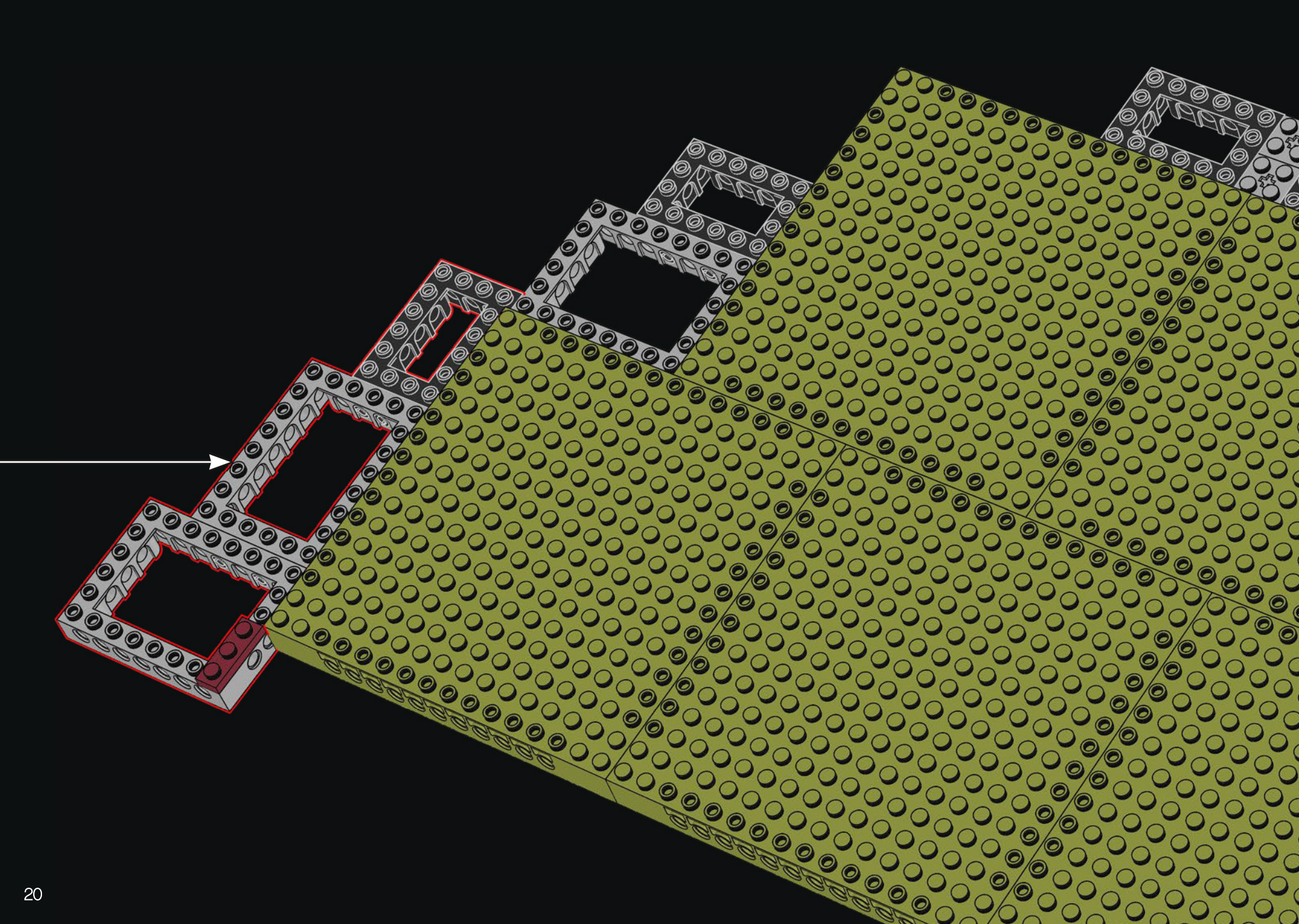

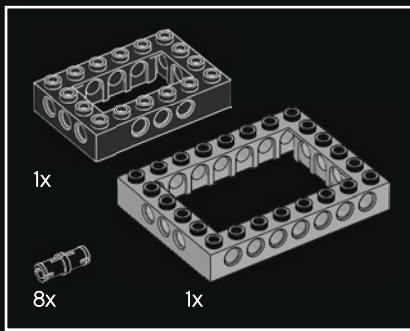

10

1

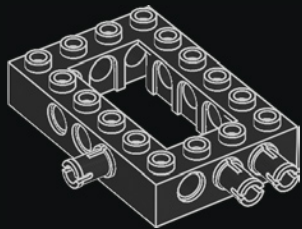

2

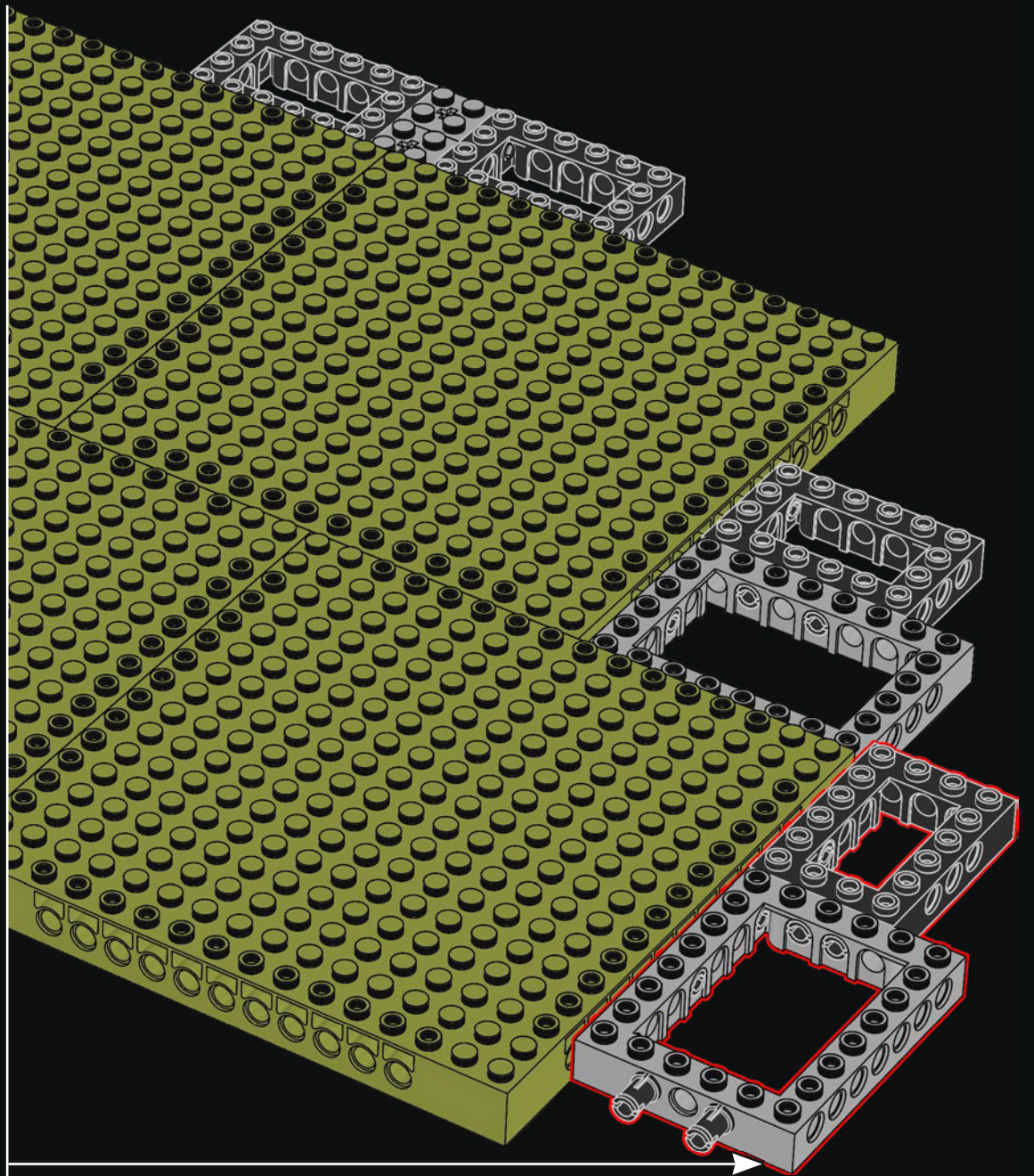
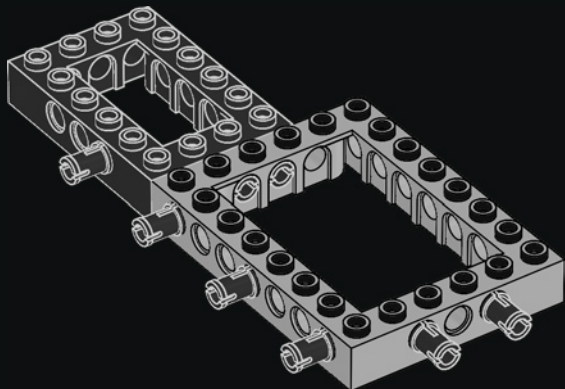

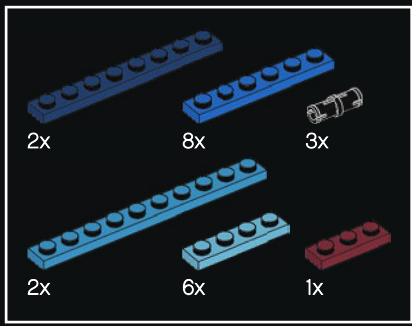

11

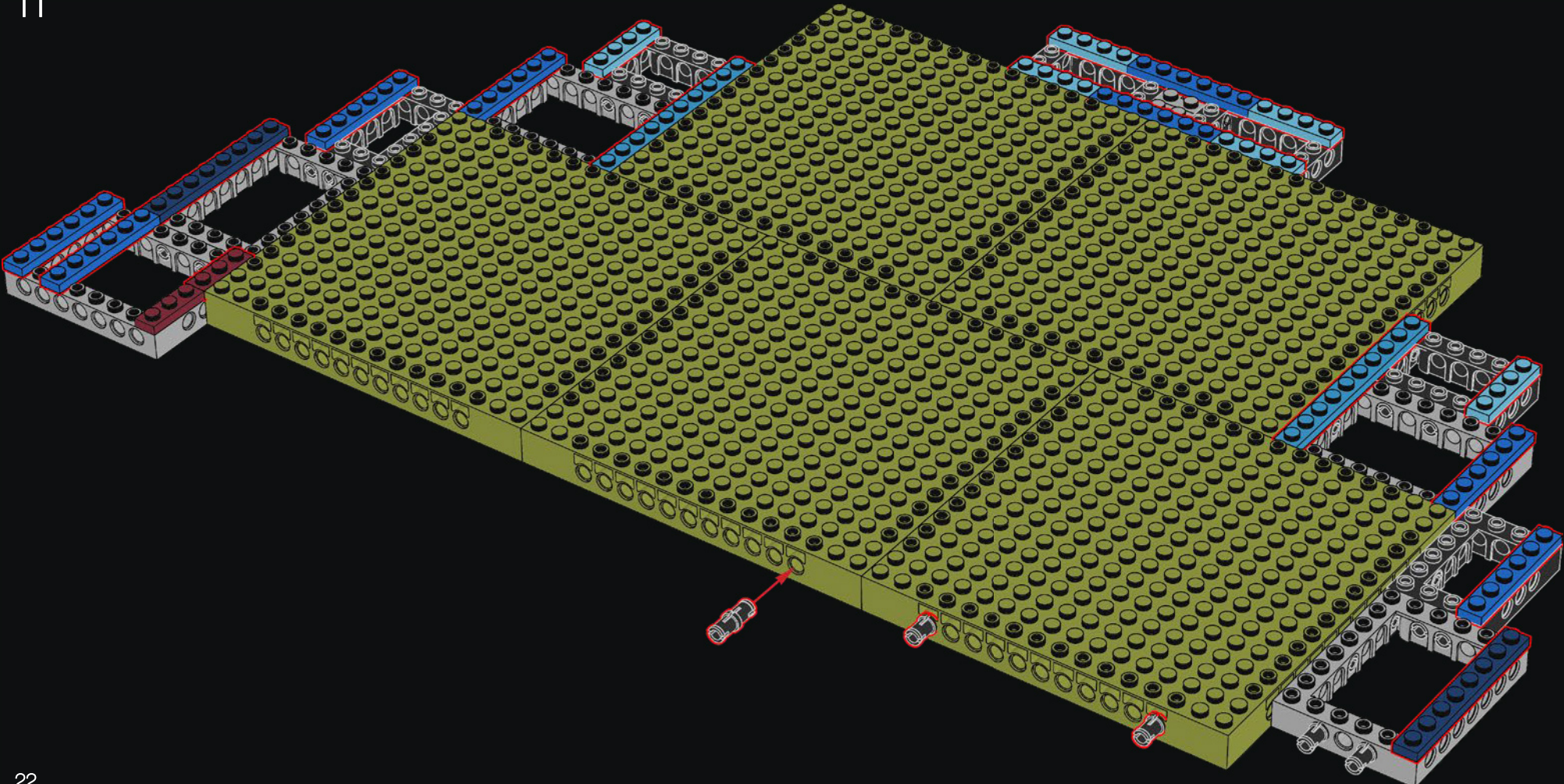

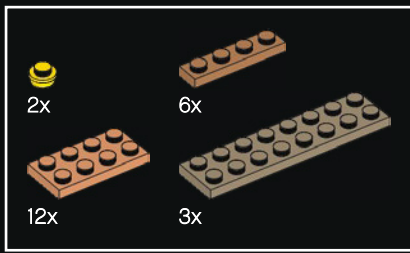

12





46x

13

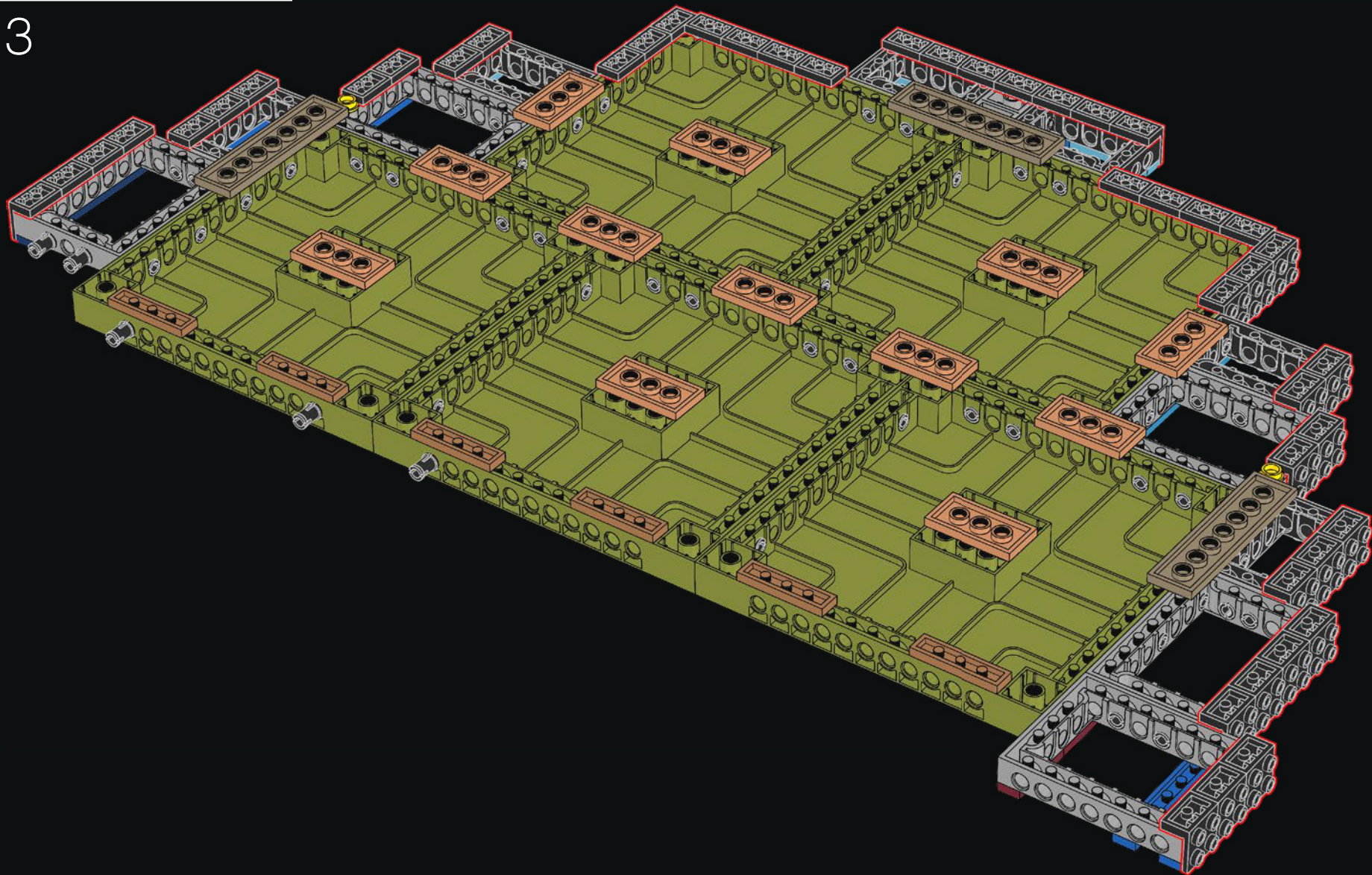

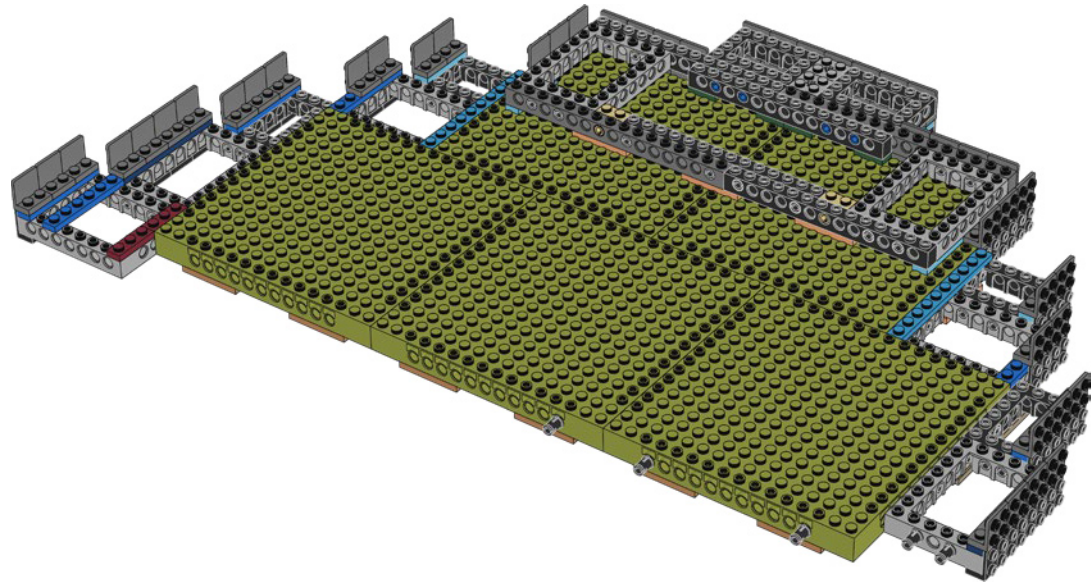
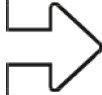



46x

14

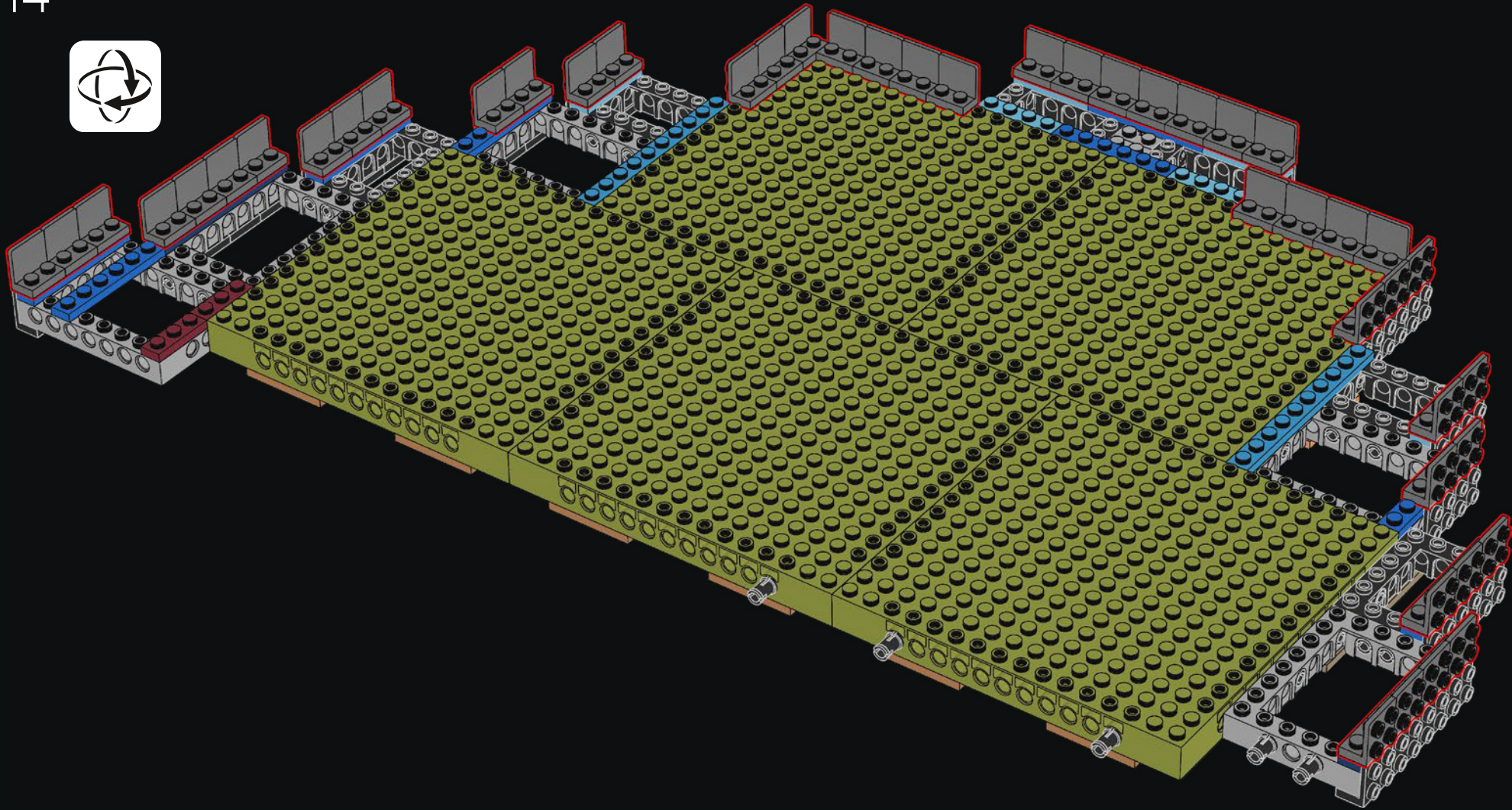

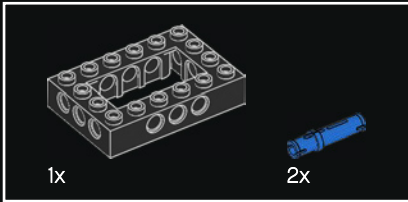
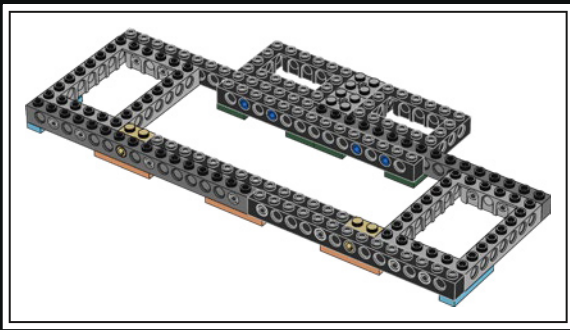

15

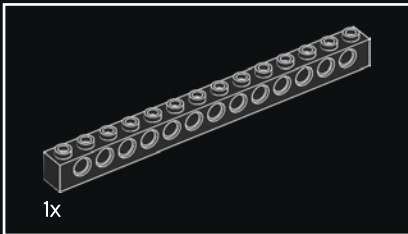
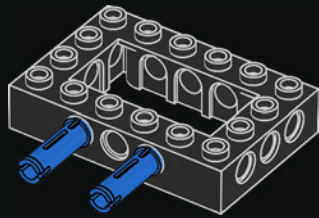

16

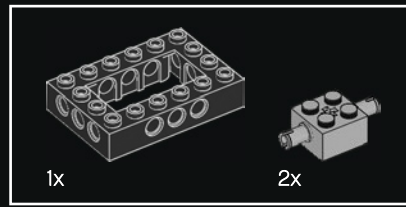
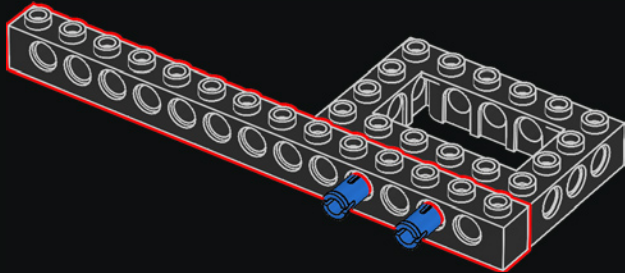

17

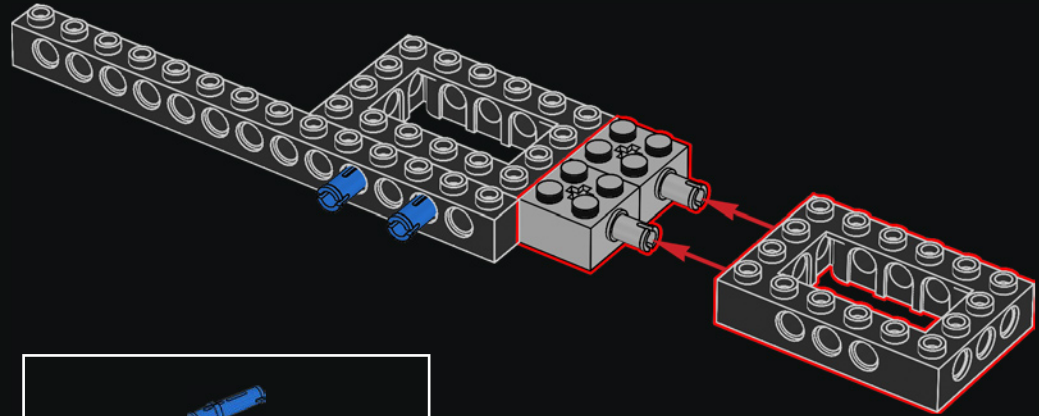

18

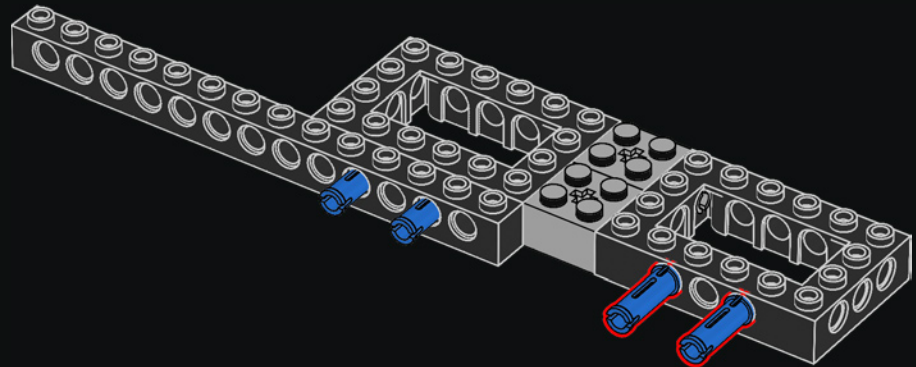

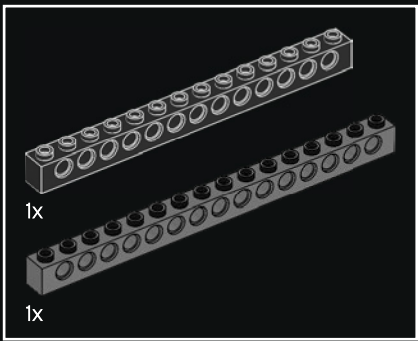

19

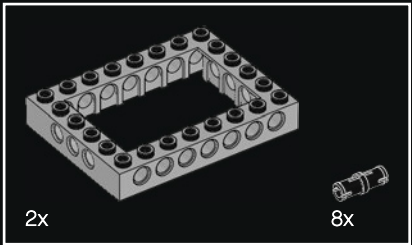
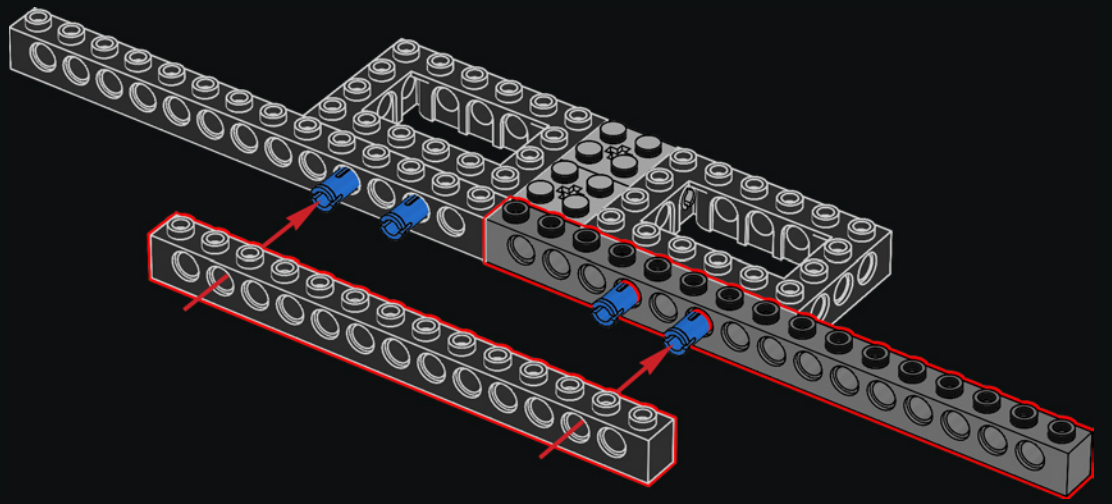

20

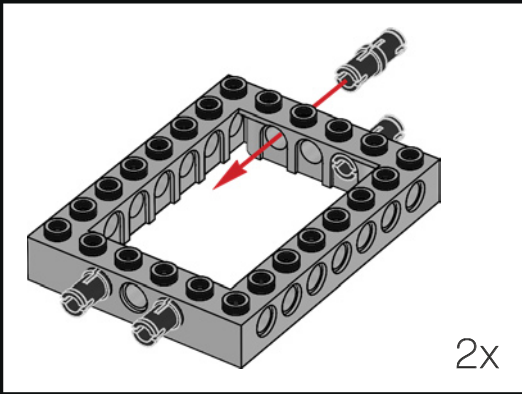
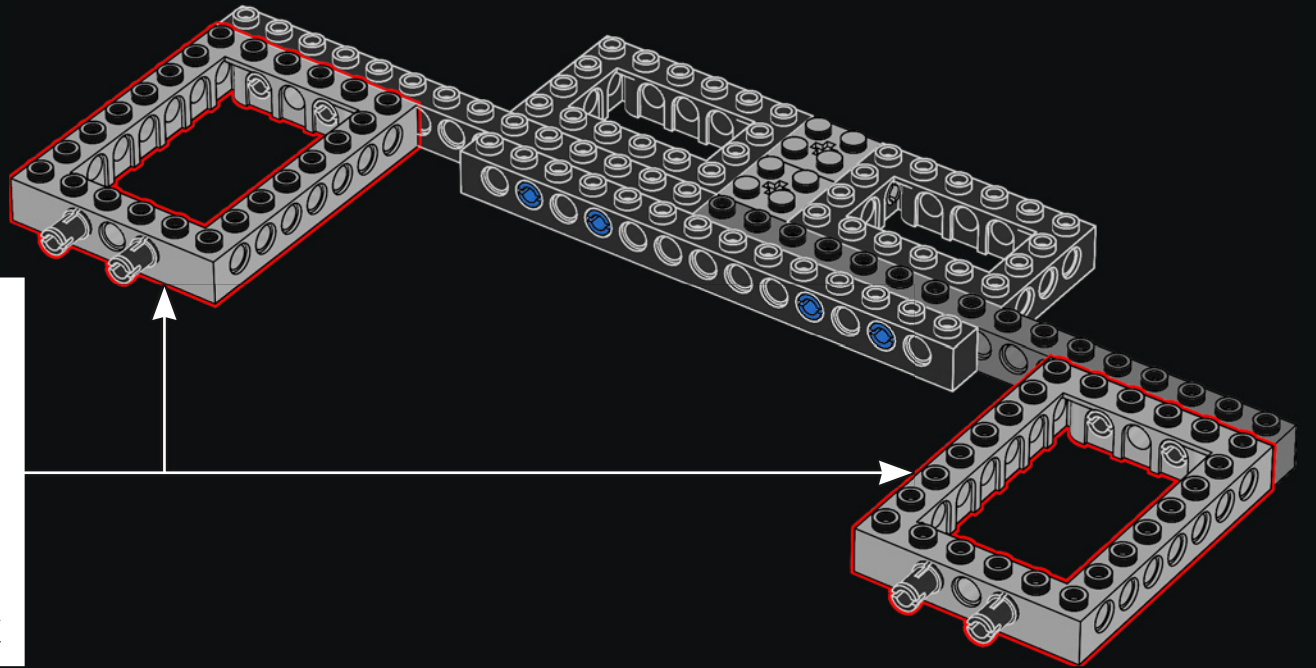

28

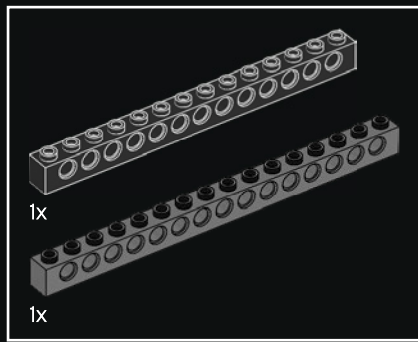

21

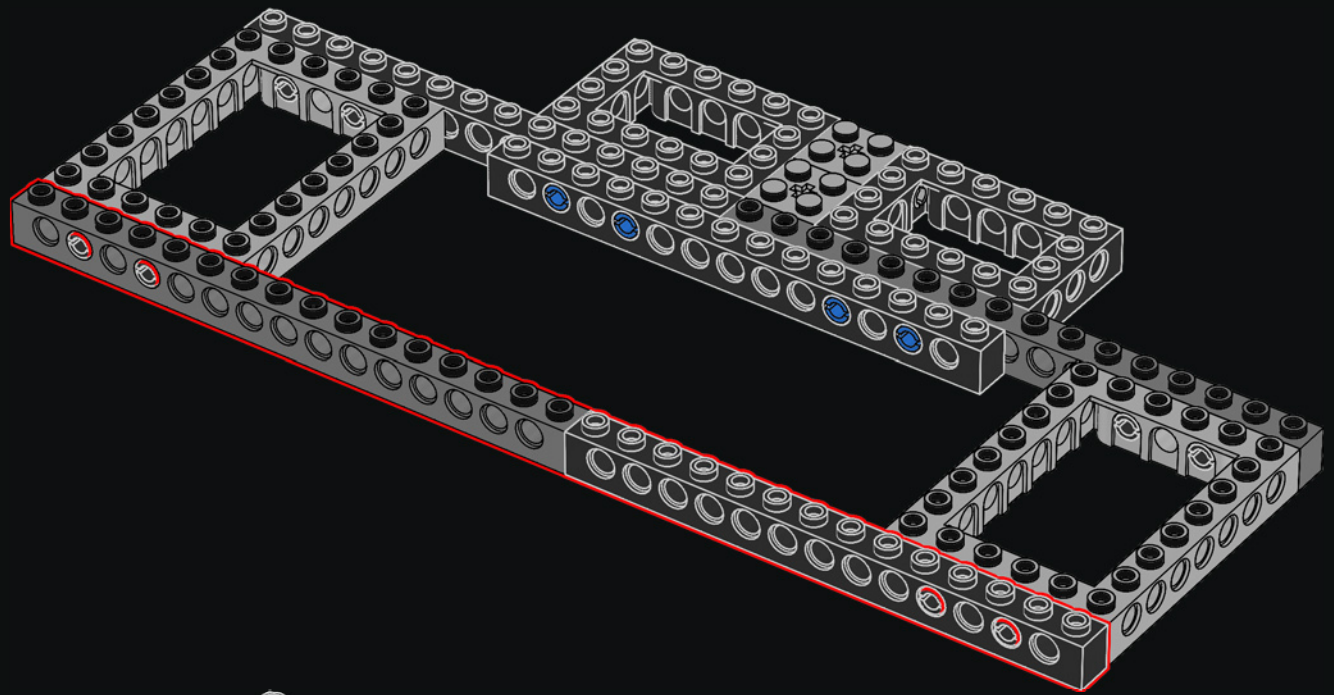

22

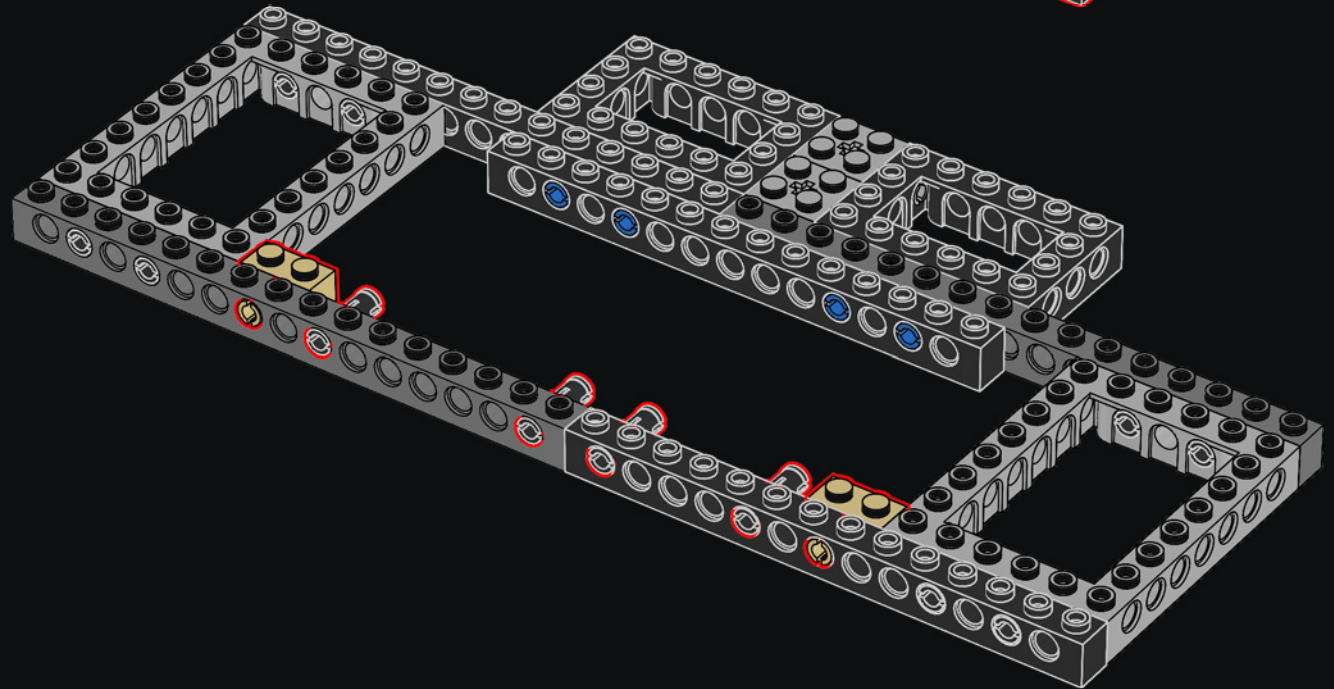

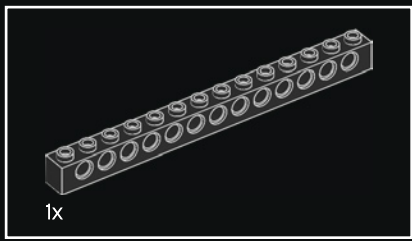

1x

23

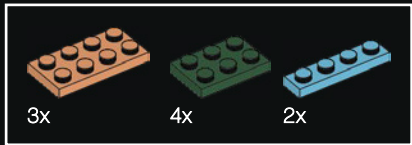
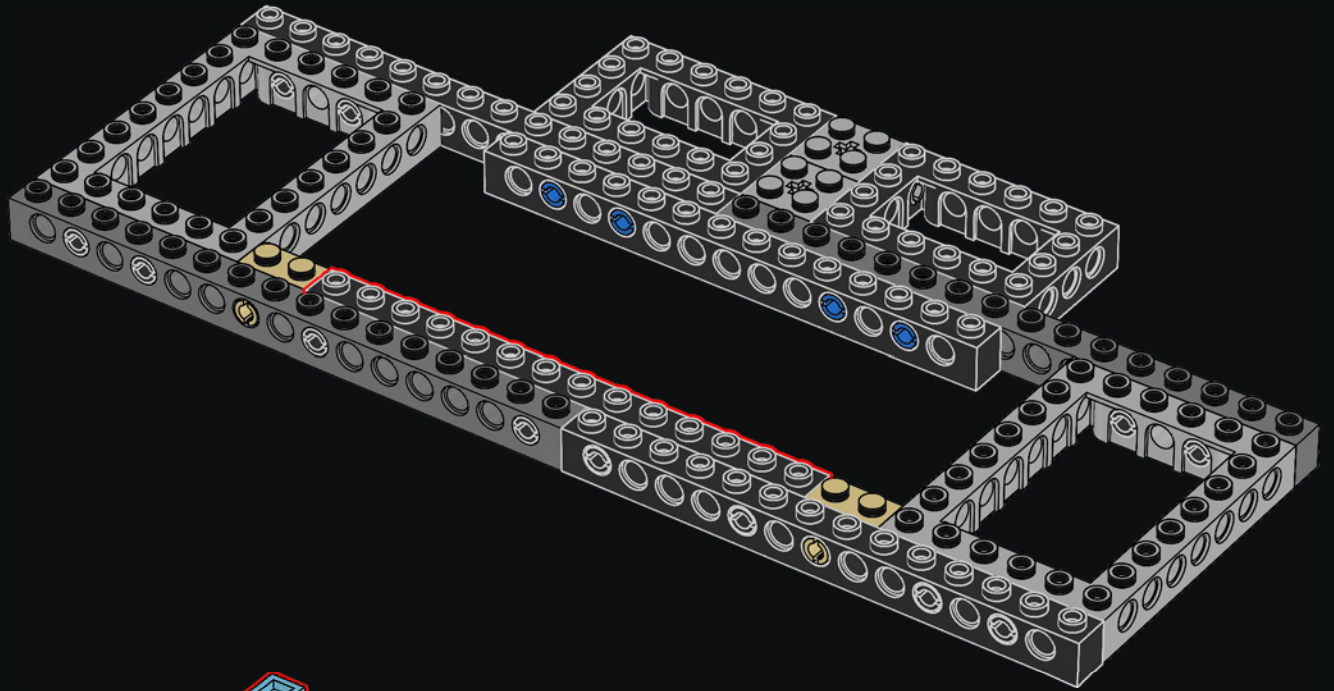

3x

4x

2x

24

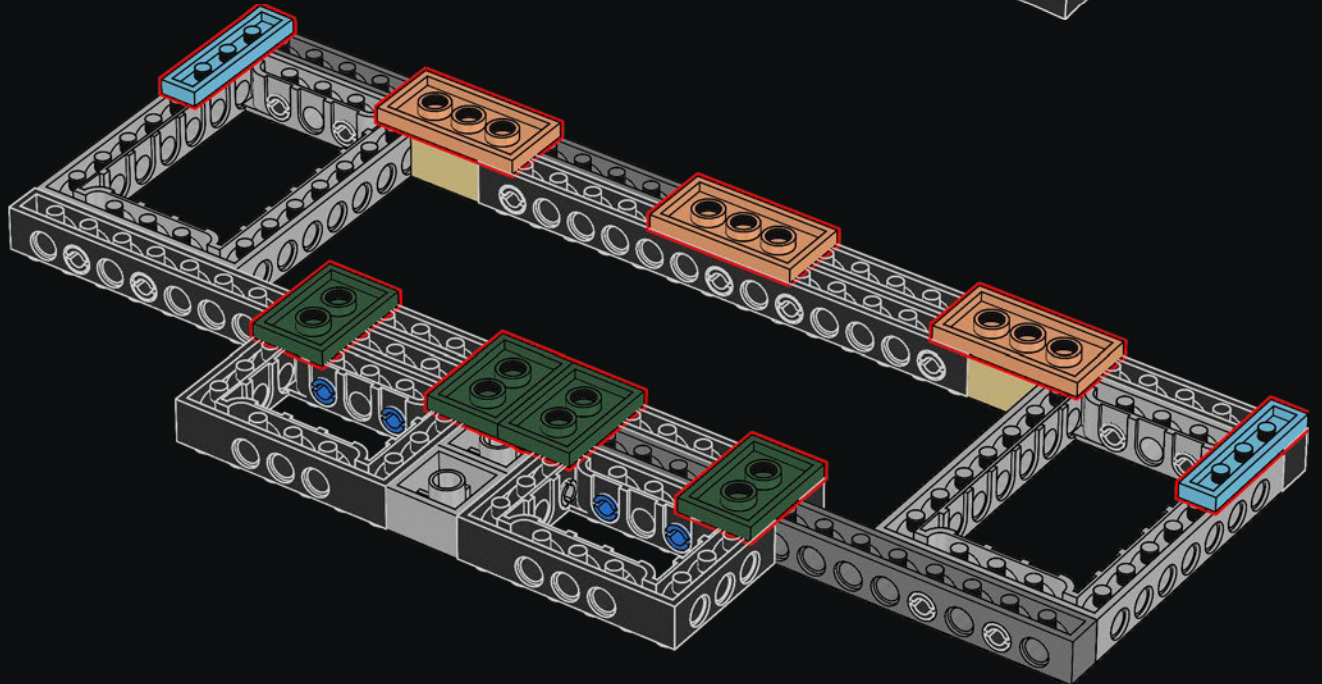

25

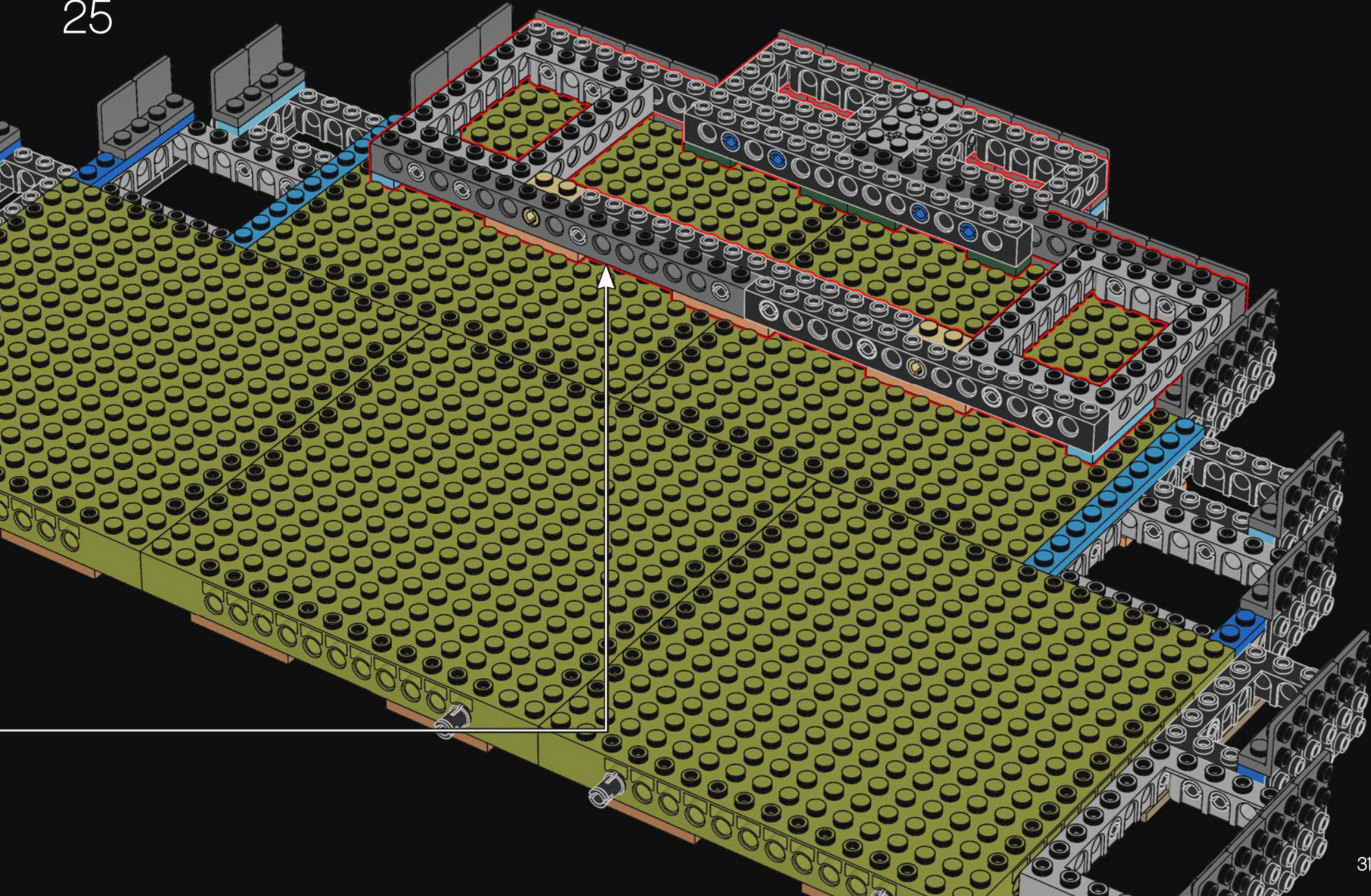

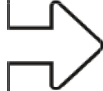

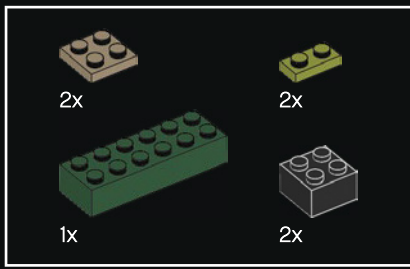

26

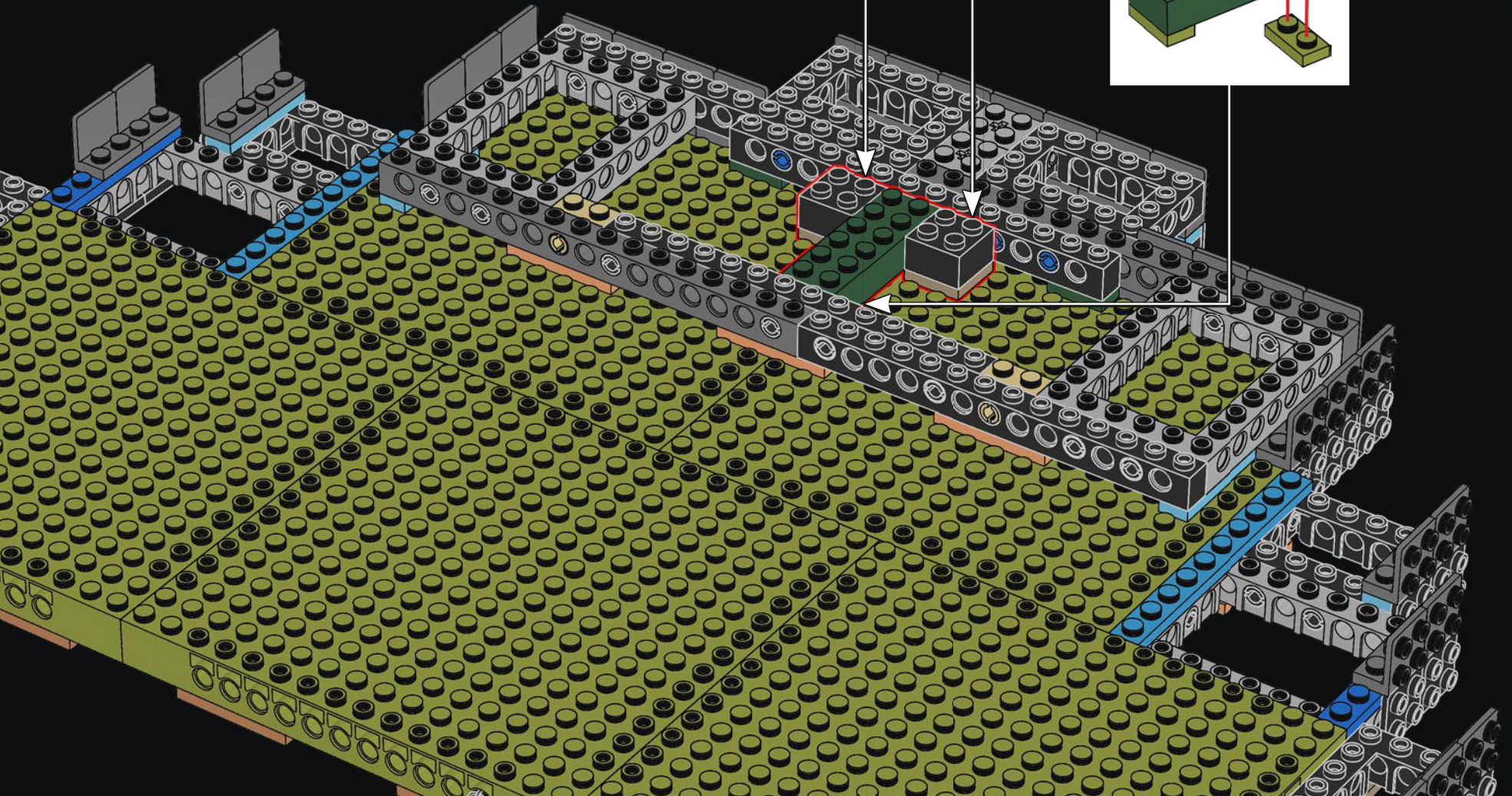
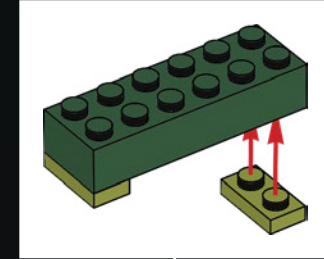
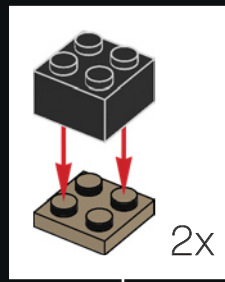

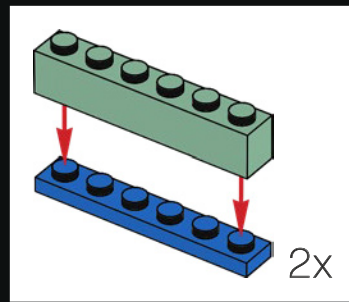
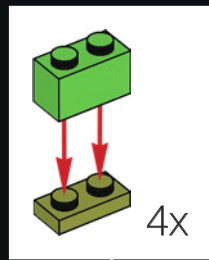
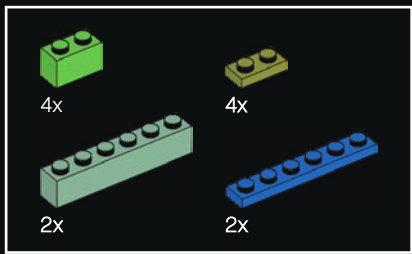

27

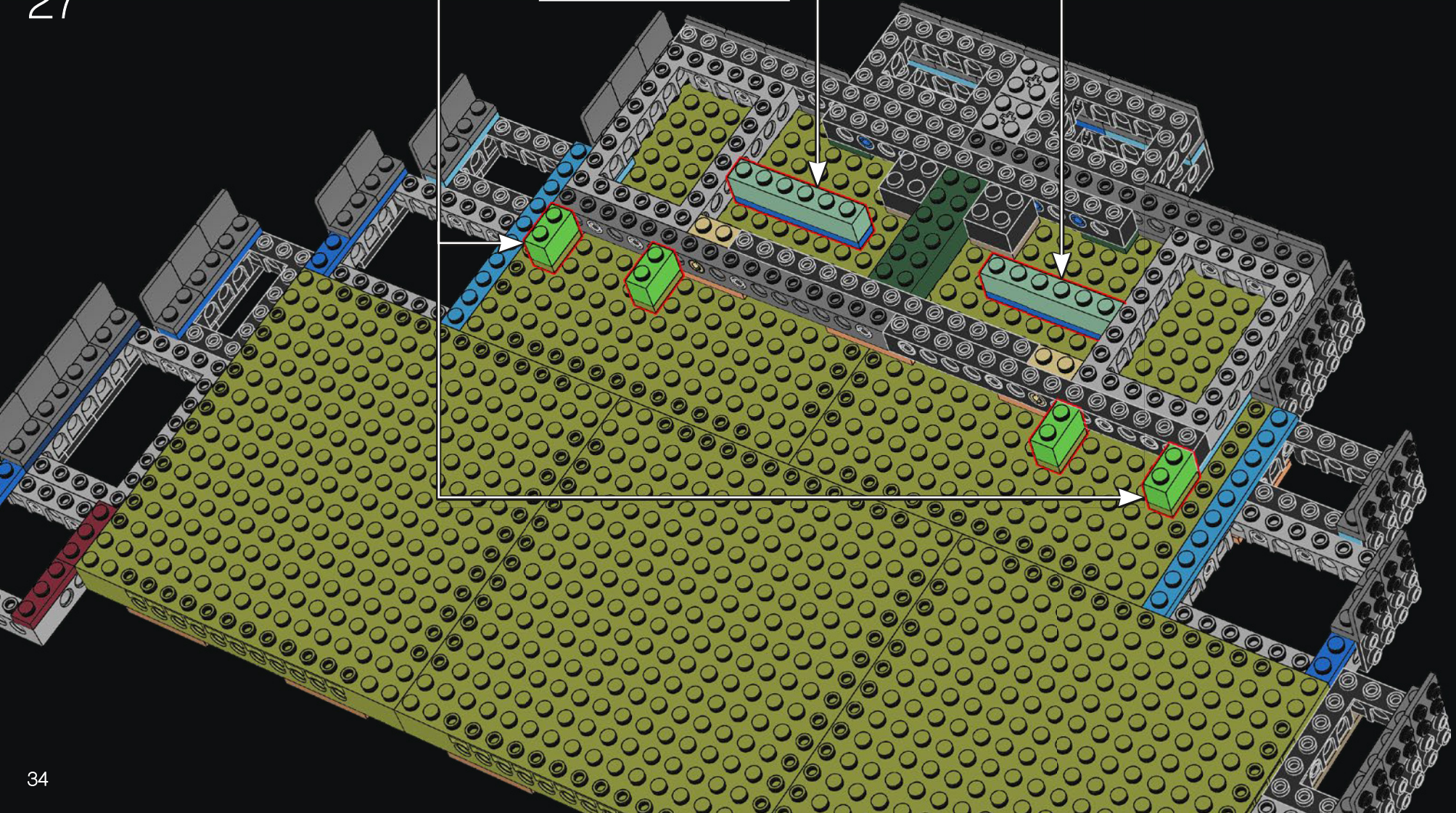

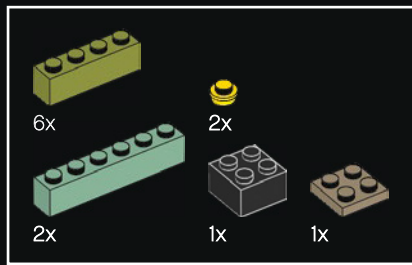

28

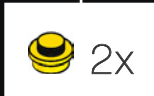
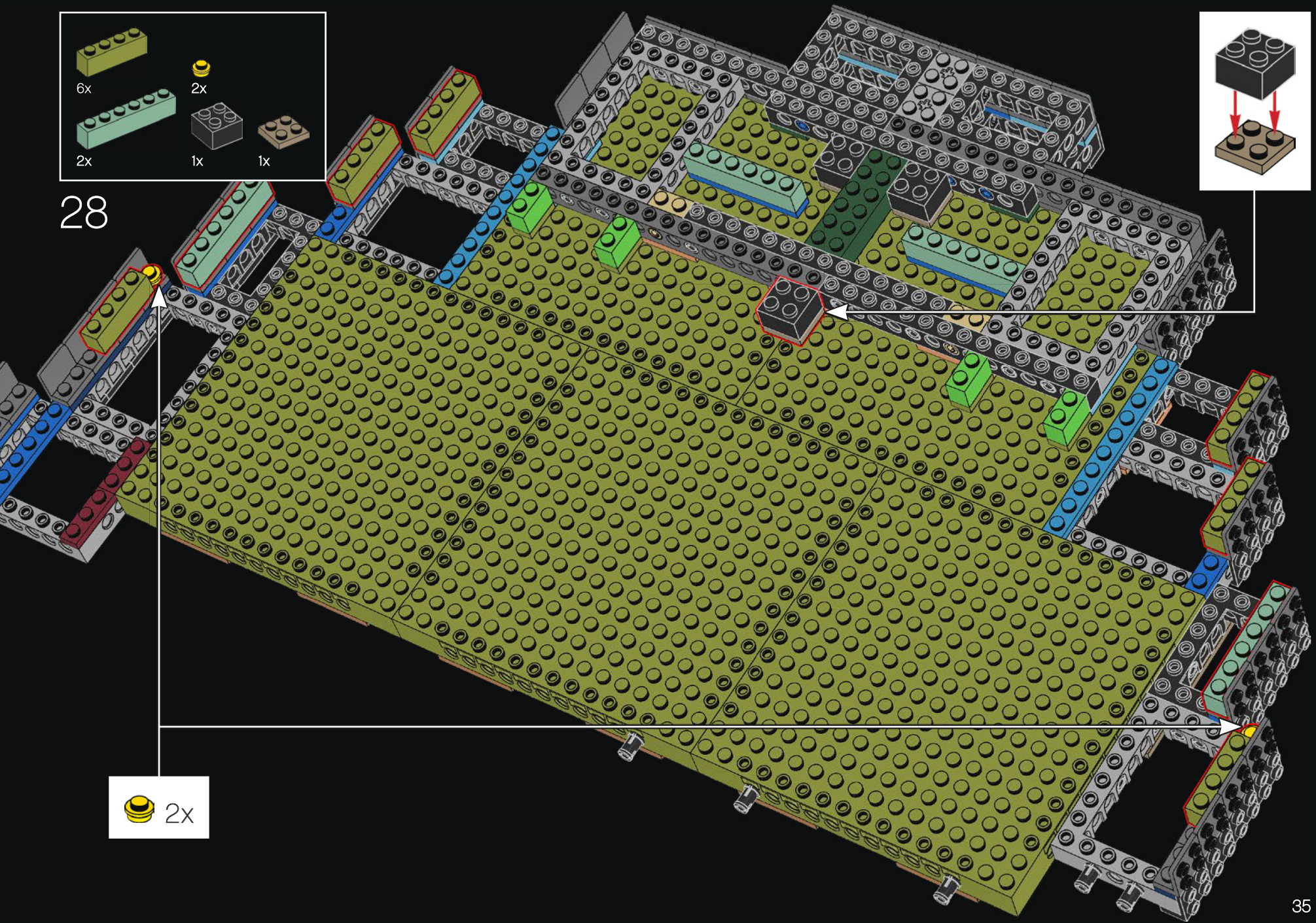
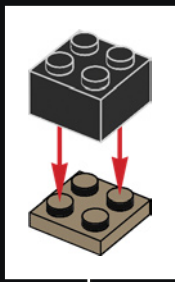

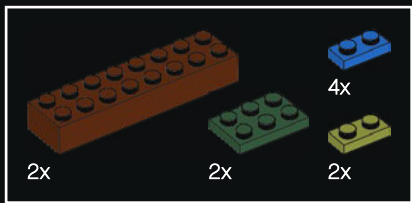

29

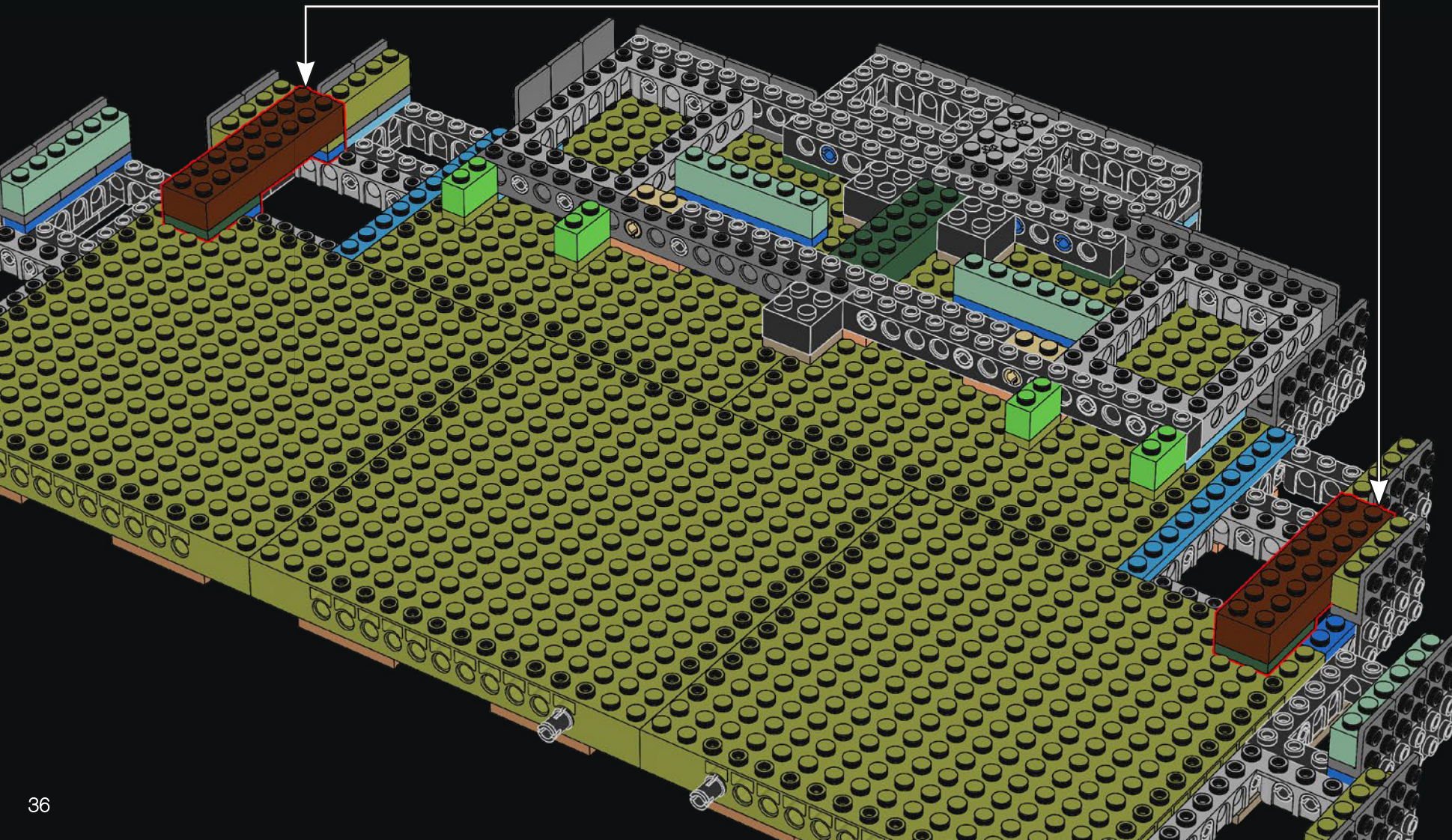
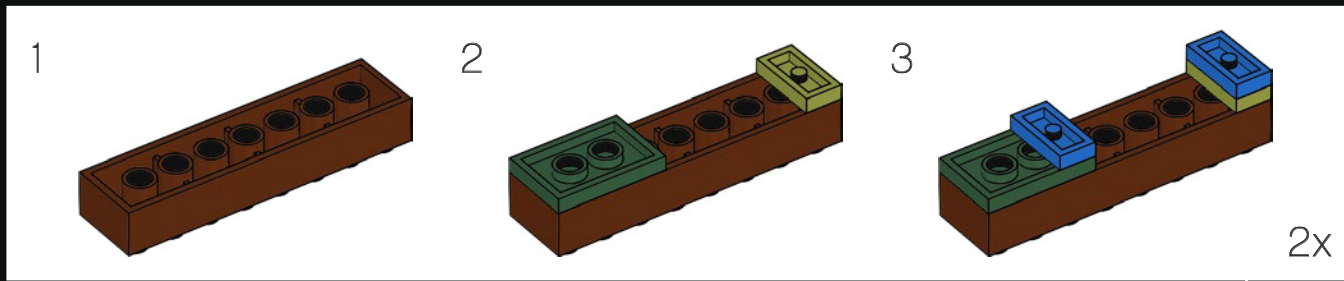

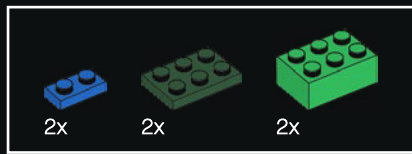

30

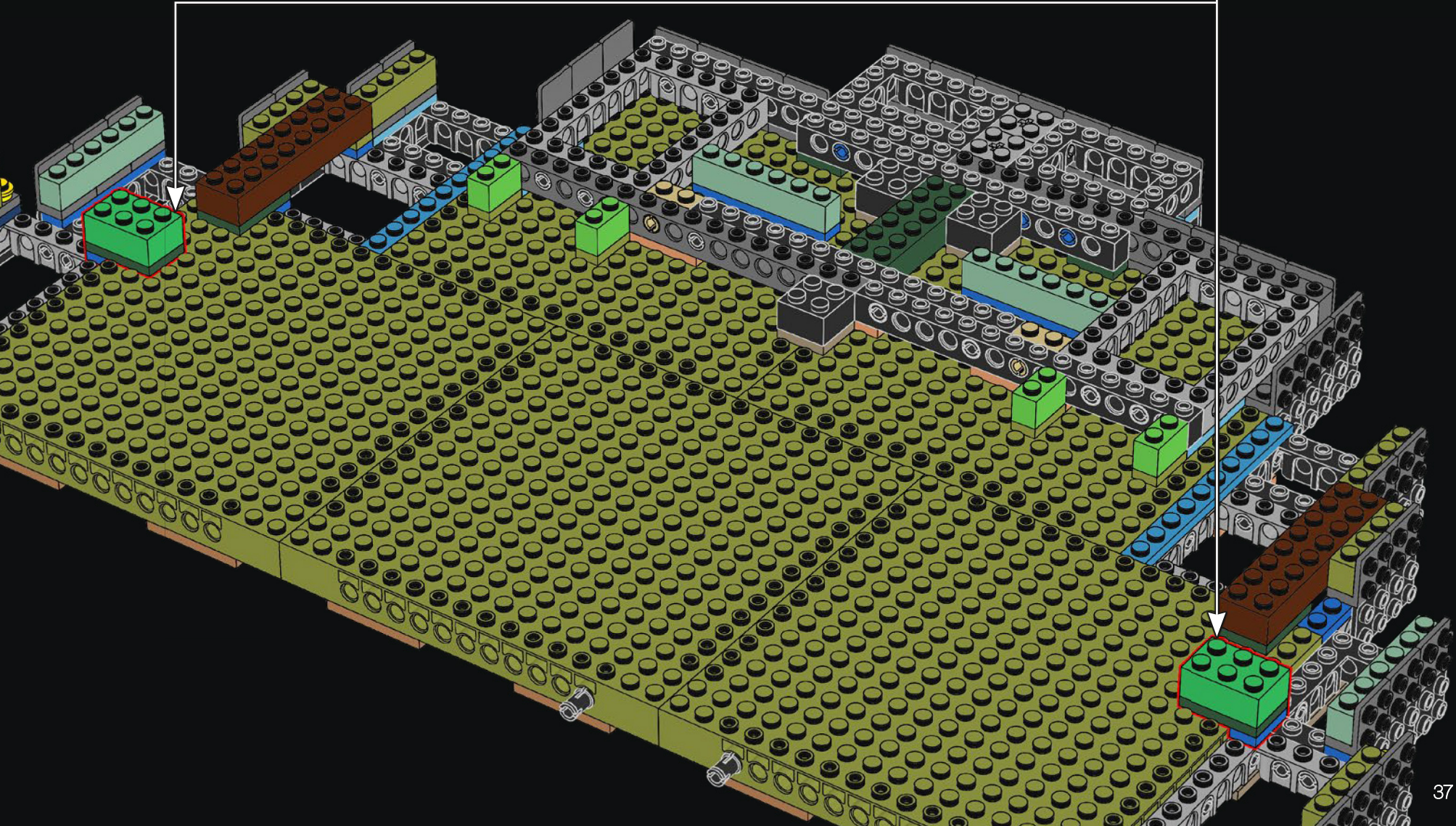
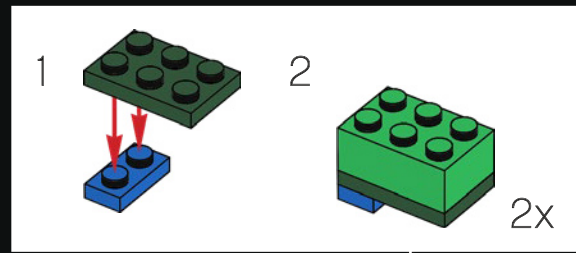

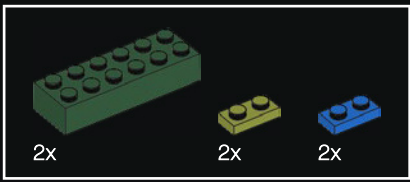

31

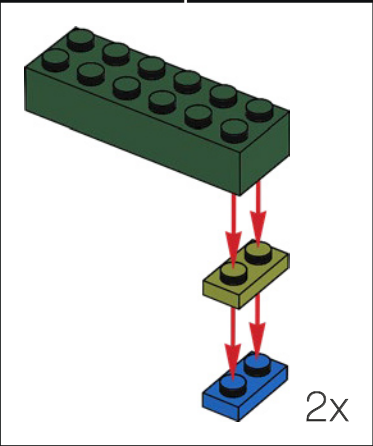
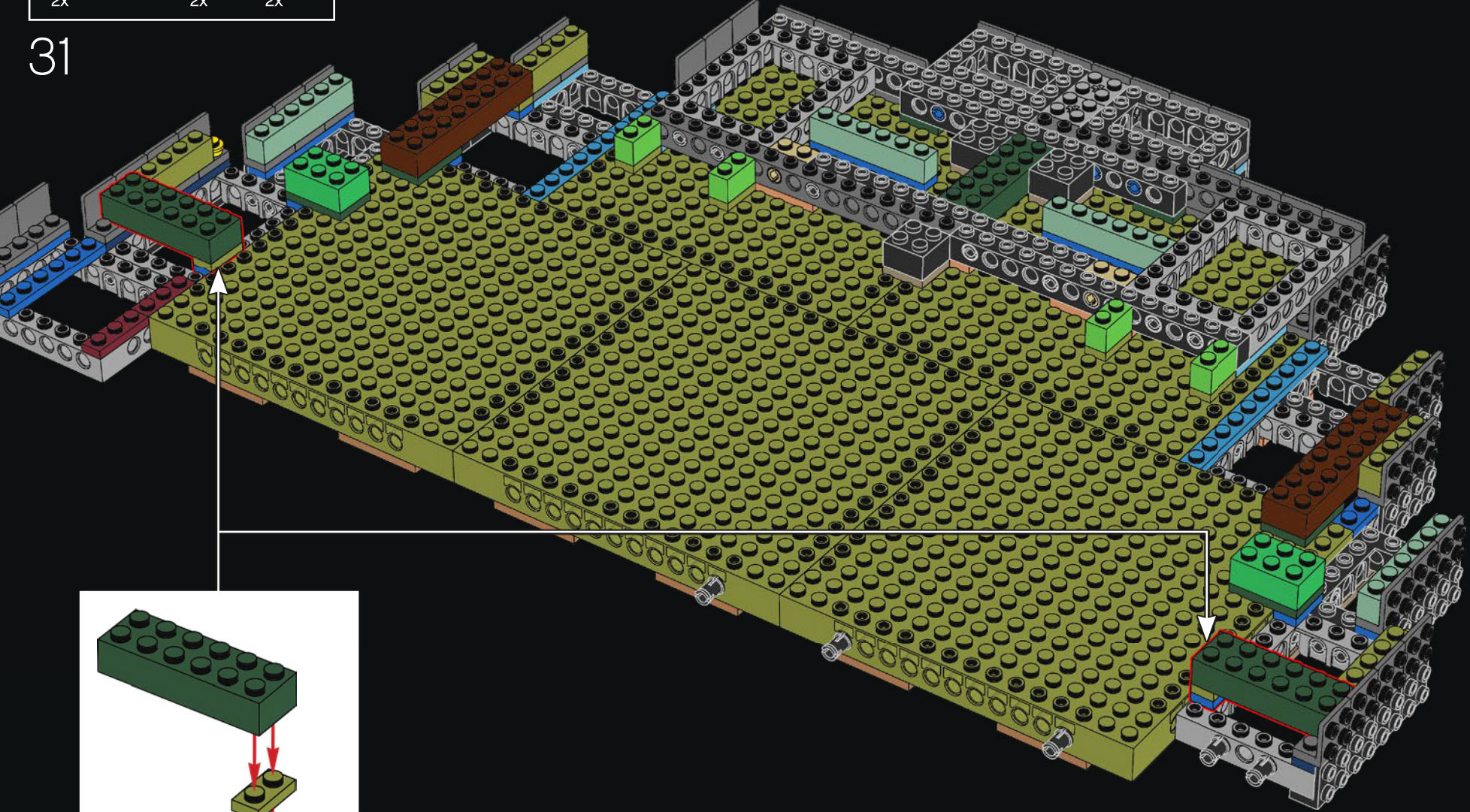

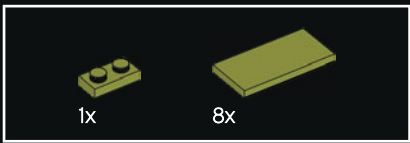

32



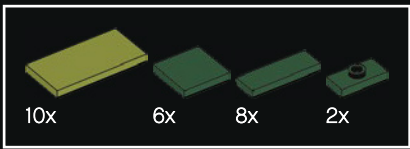

33



34

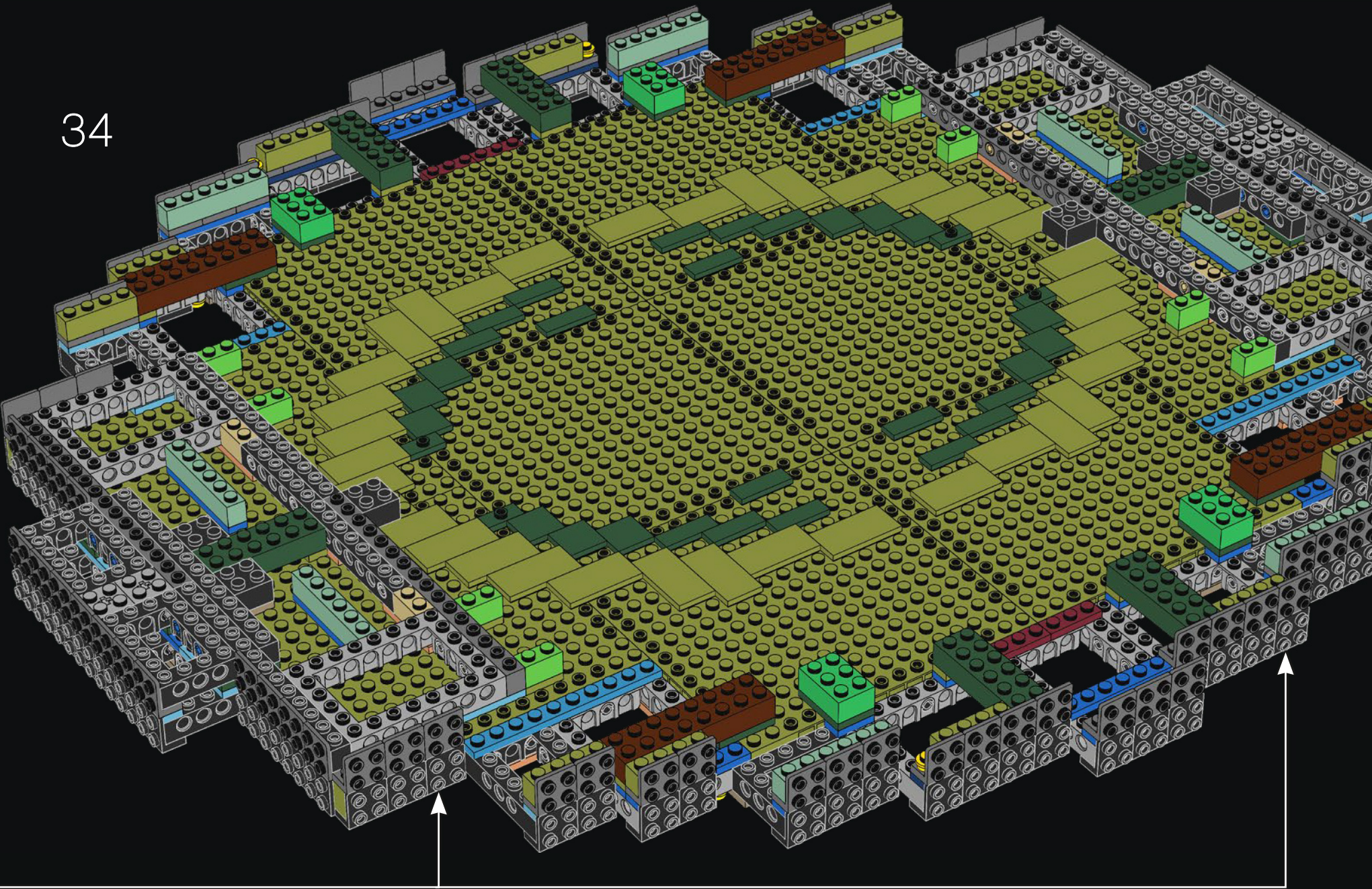

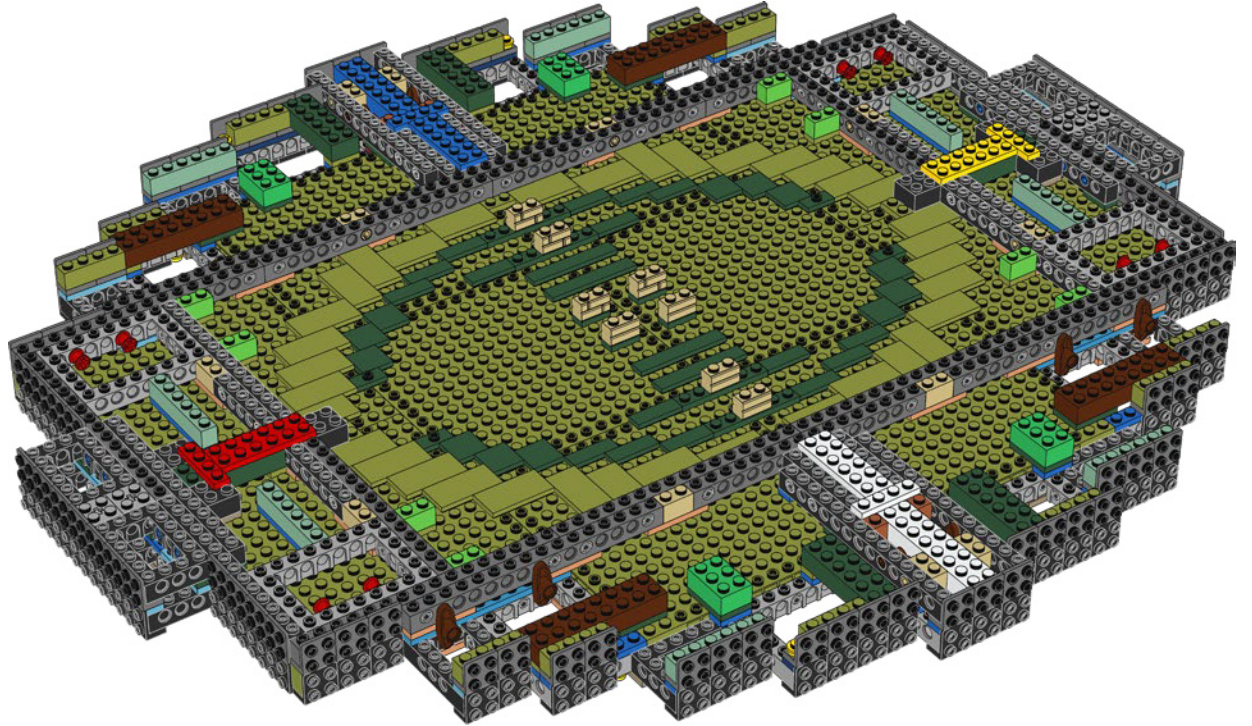
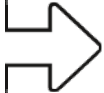

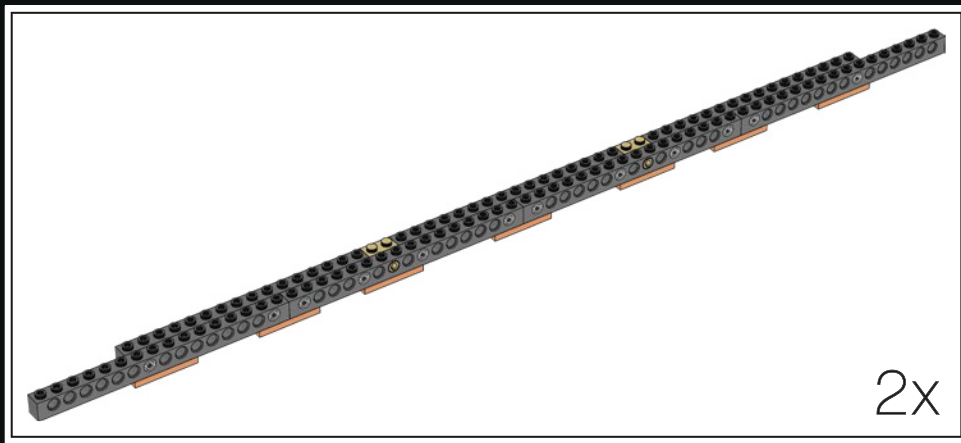

2x

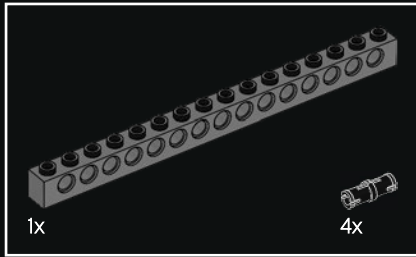

1x

4x

35

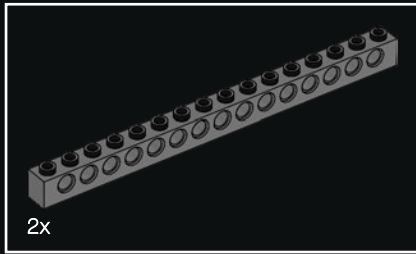
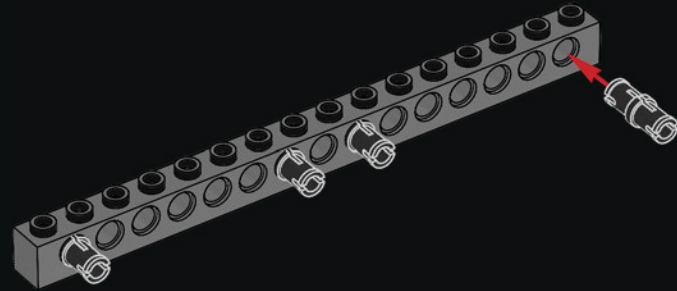

2x

36

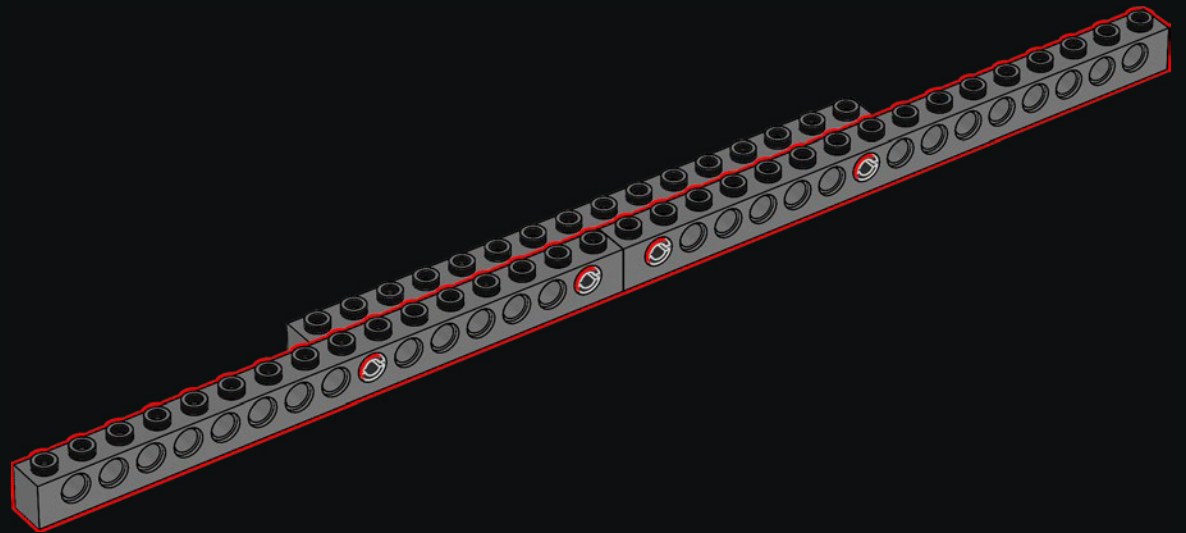



37

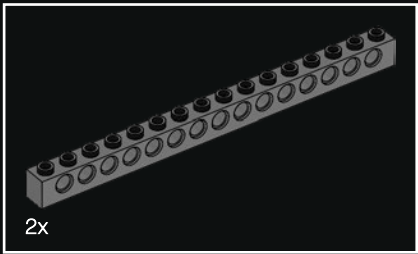
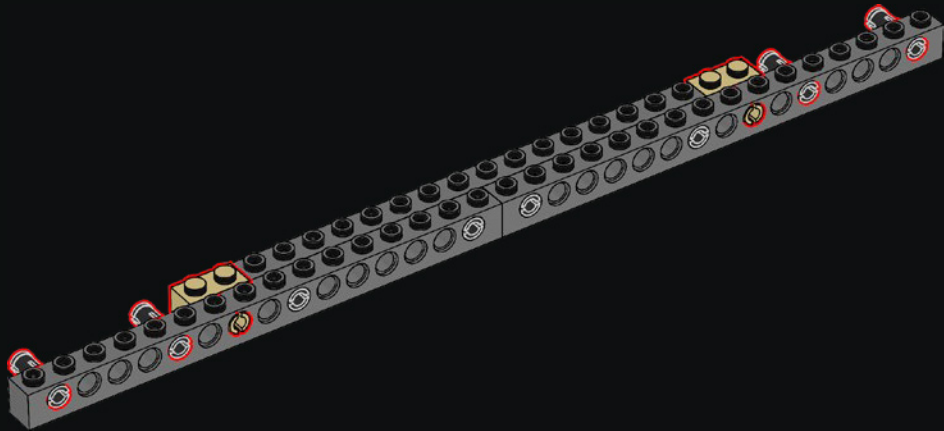

38

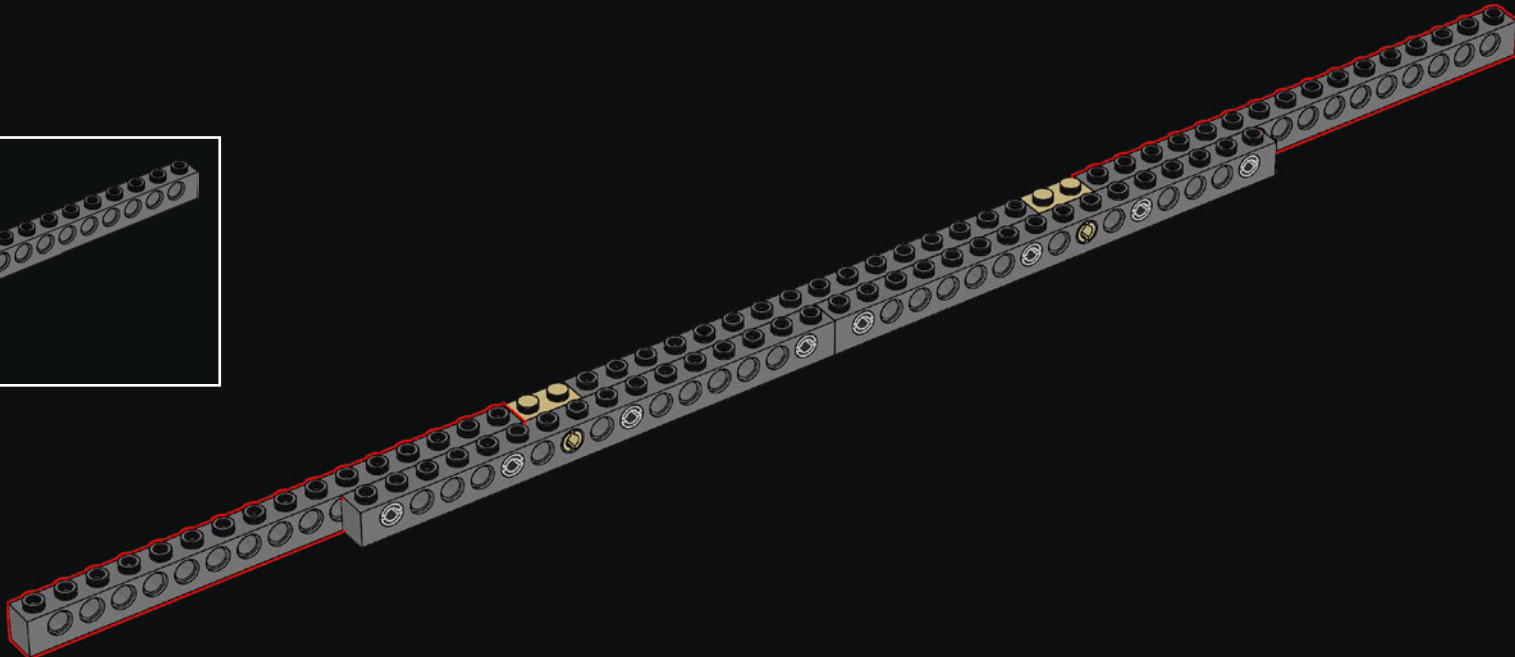



39

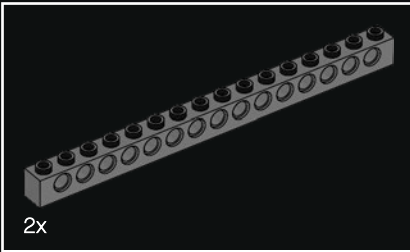
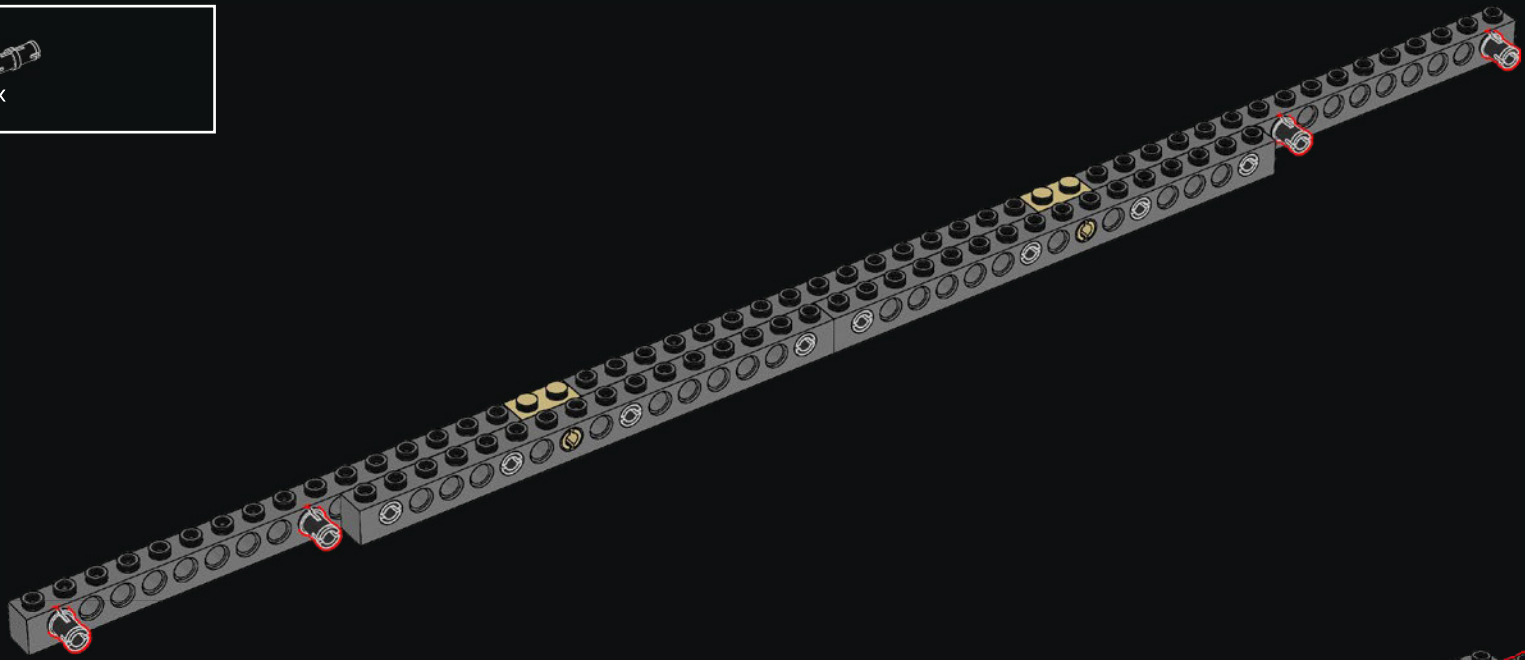

40



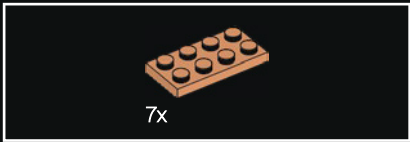

41

El Coliseo se conoce también como *Anfiteatro Flavio* en honor a los 3 emperadores de la dinastía flavia que lo construyeron y reformaron.

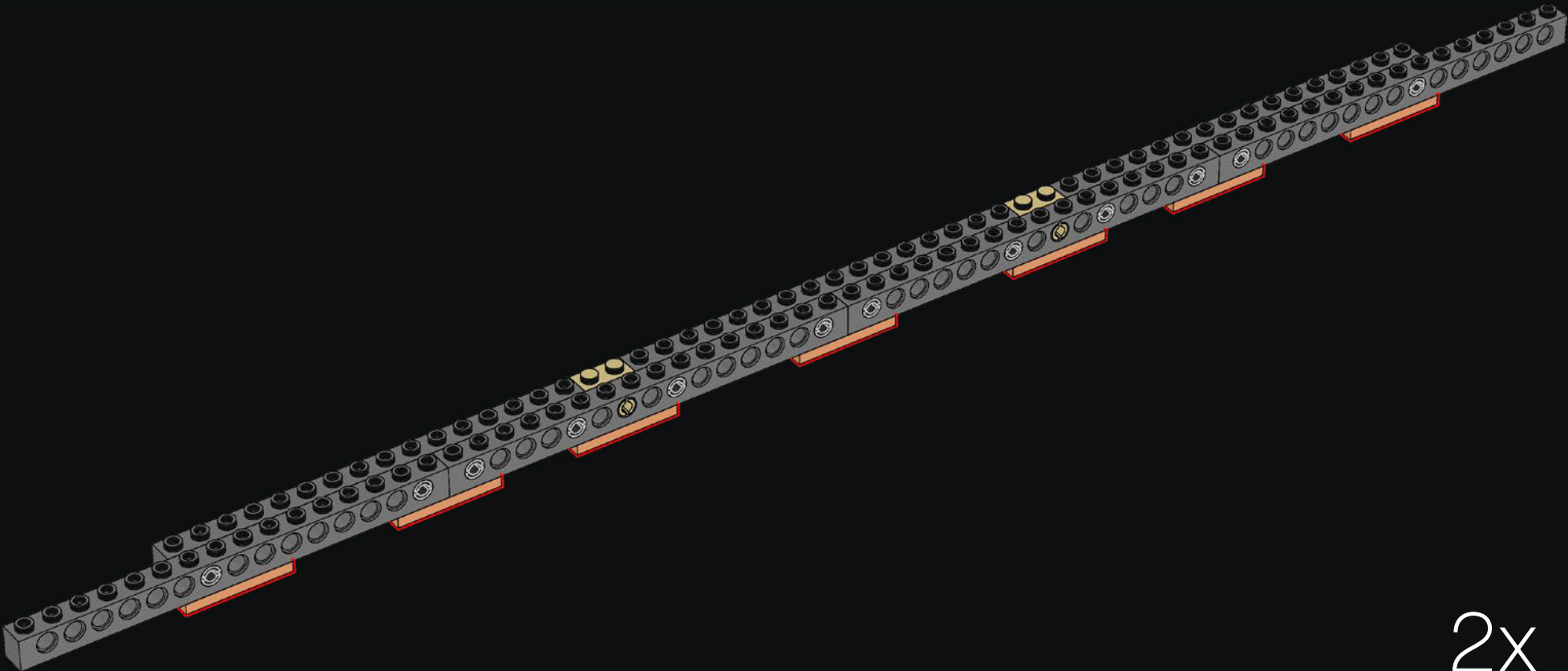

2x

42

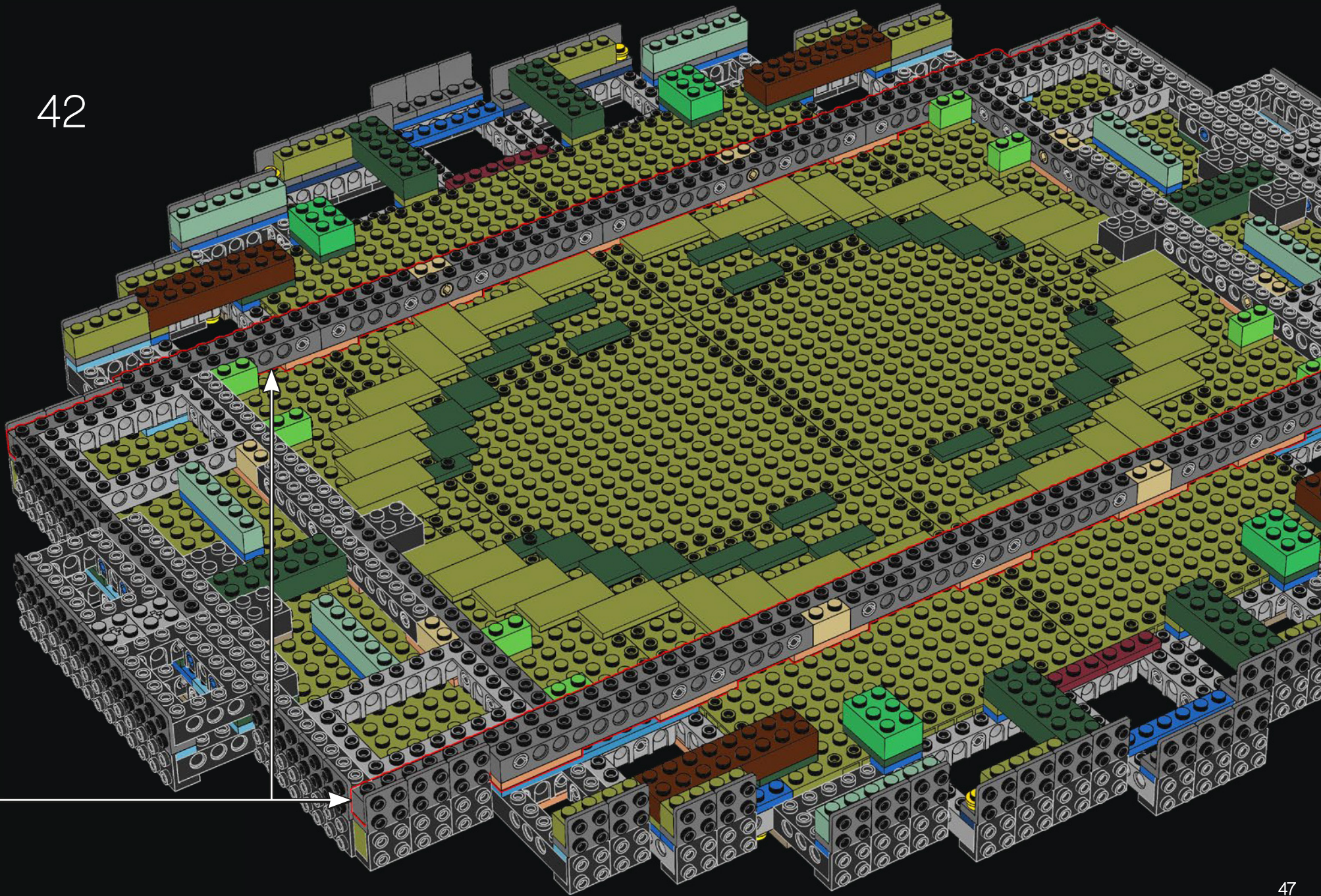



43

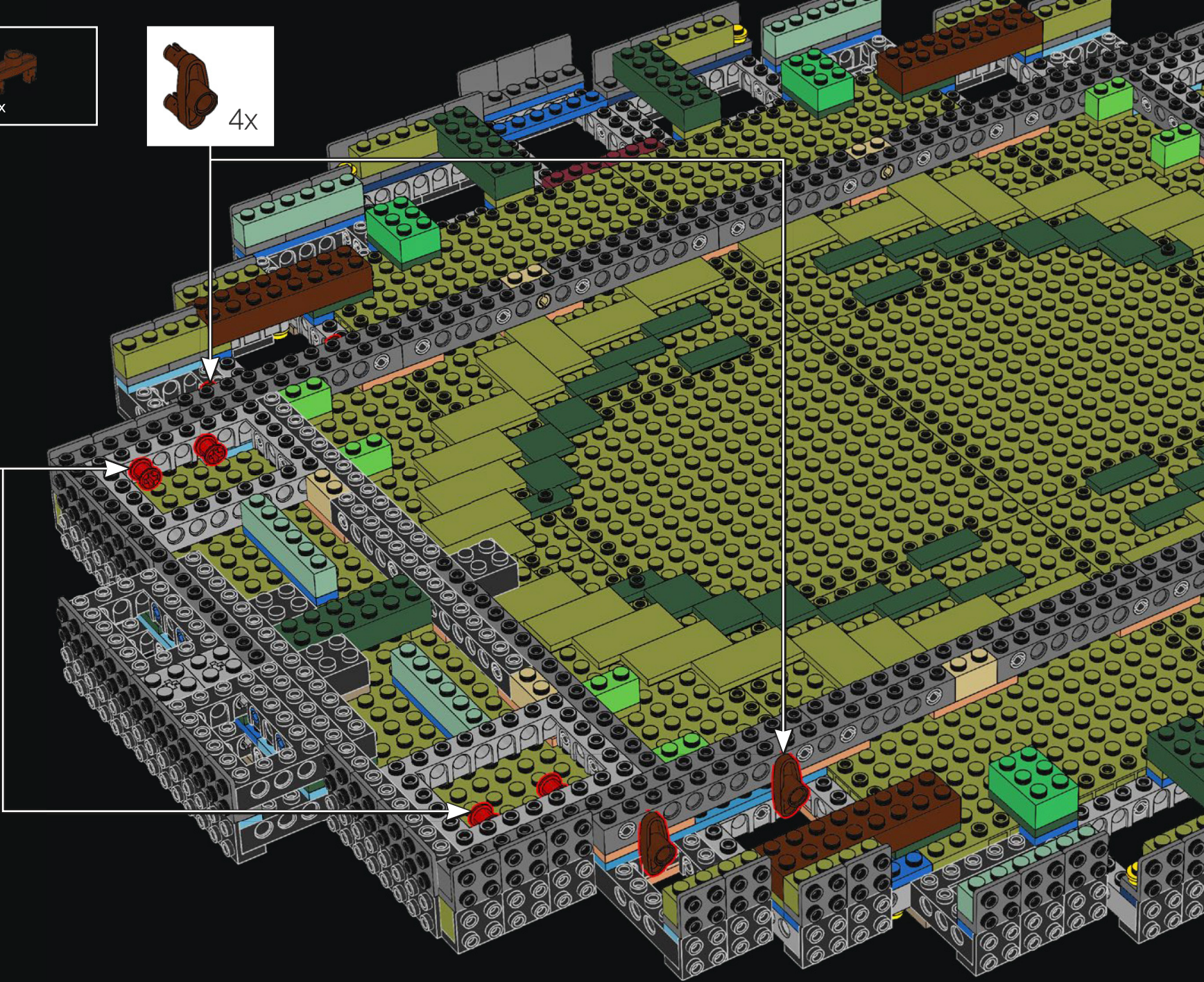



44

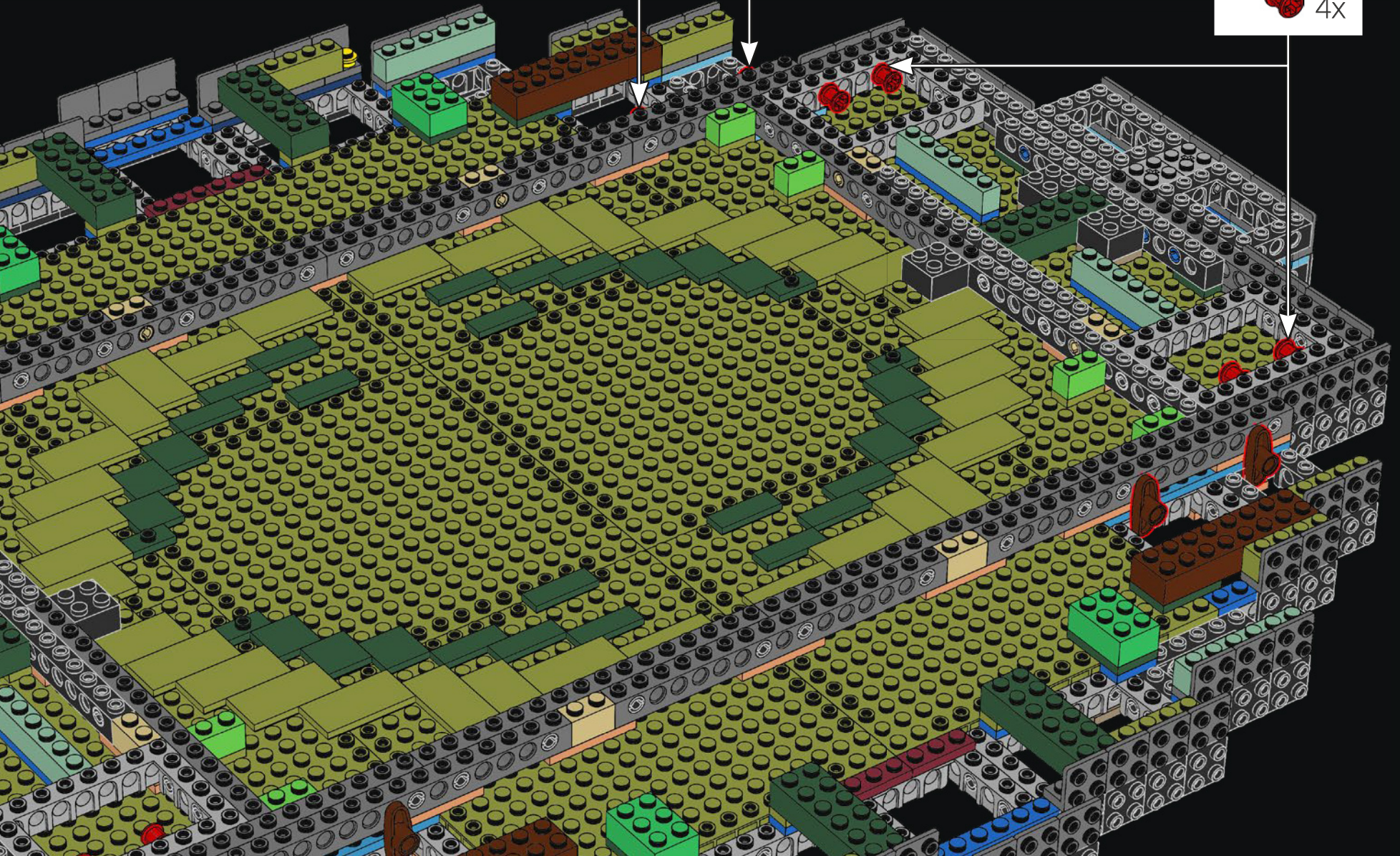

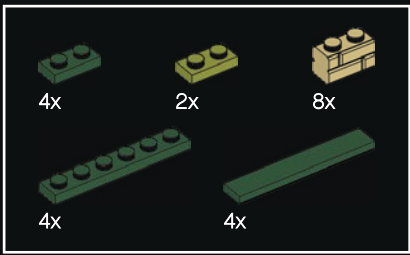

45

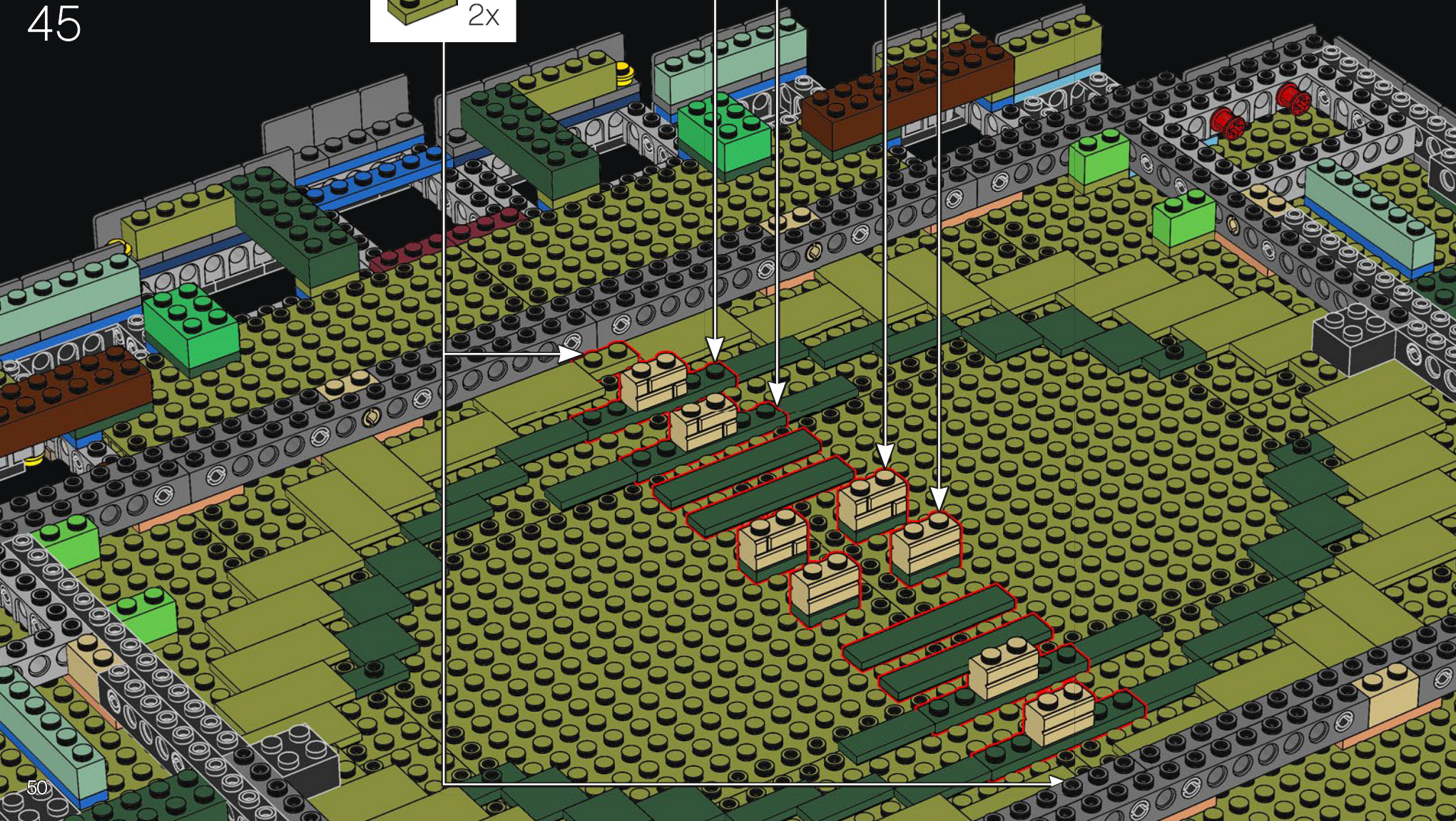
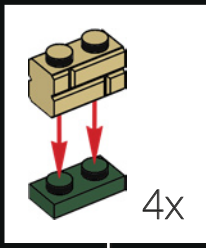
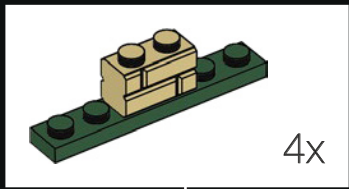
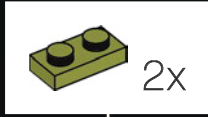

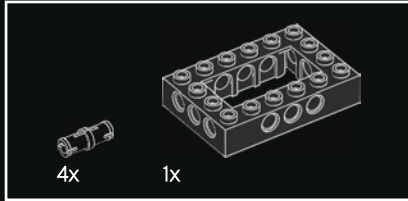
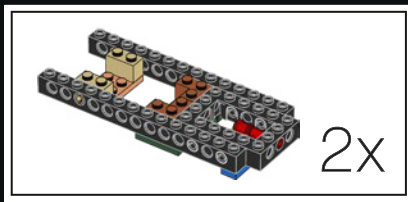

46

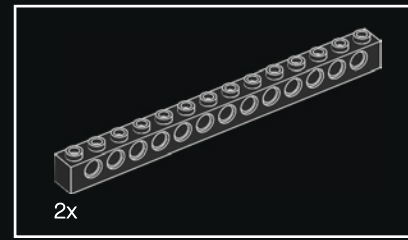
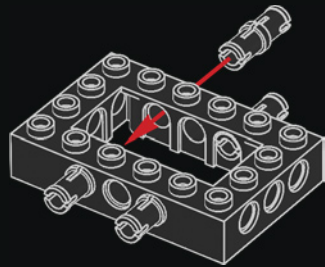

47

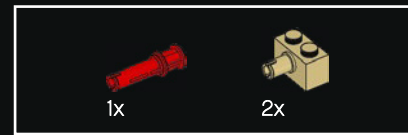
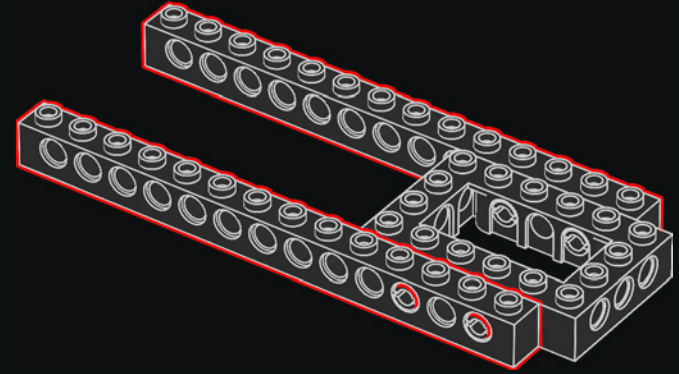

48

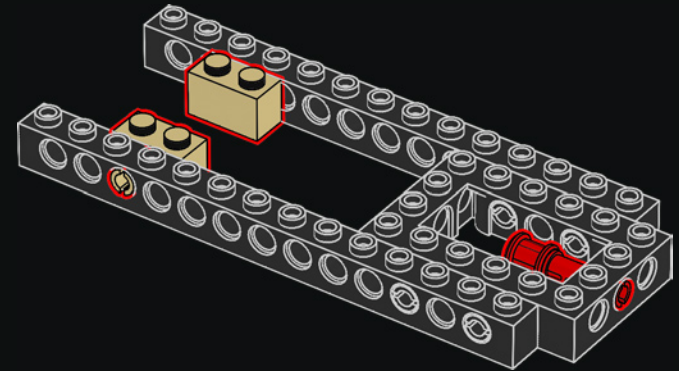

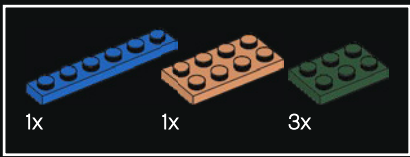

49

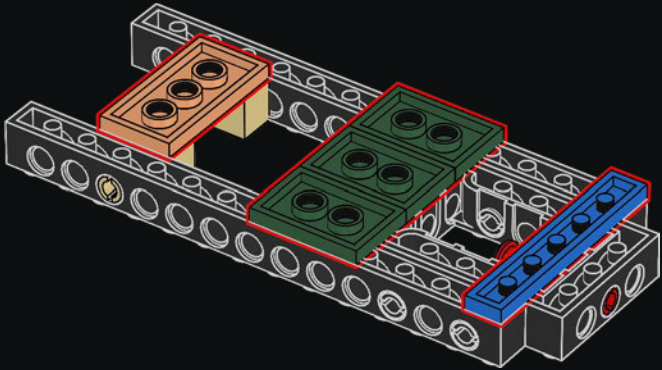

50

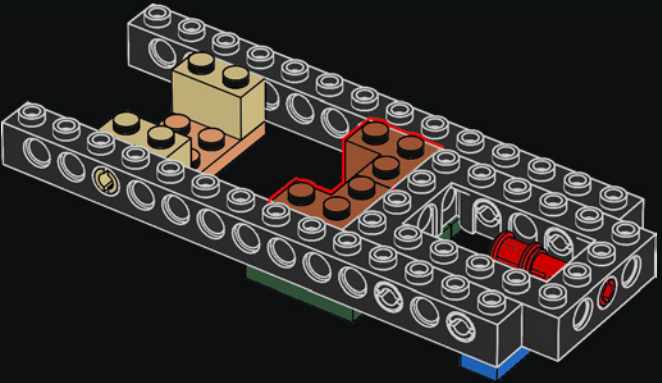

2x

51

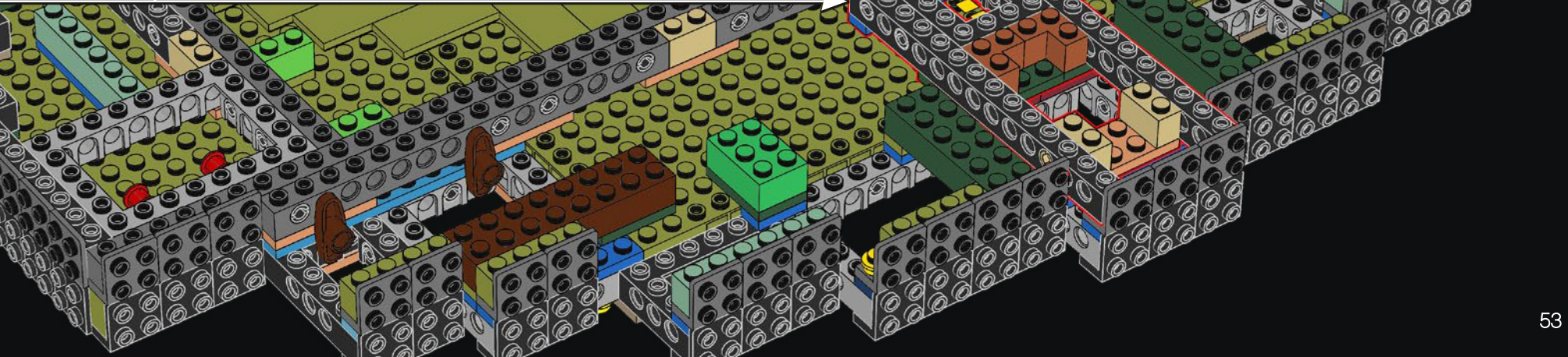
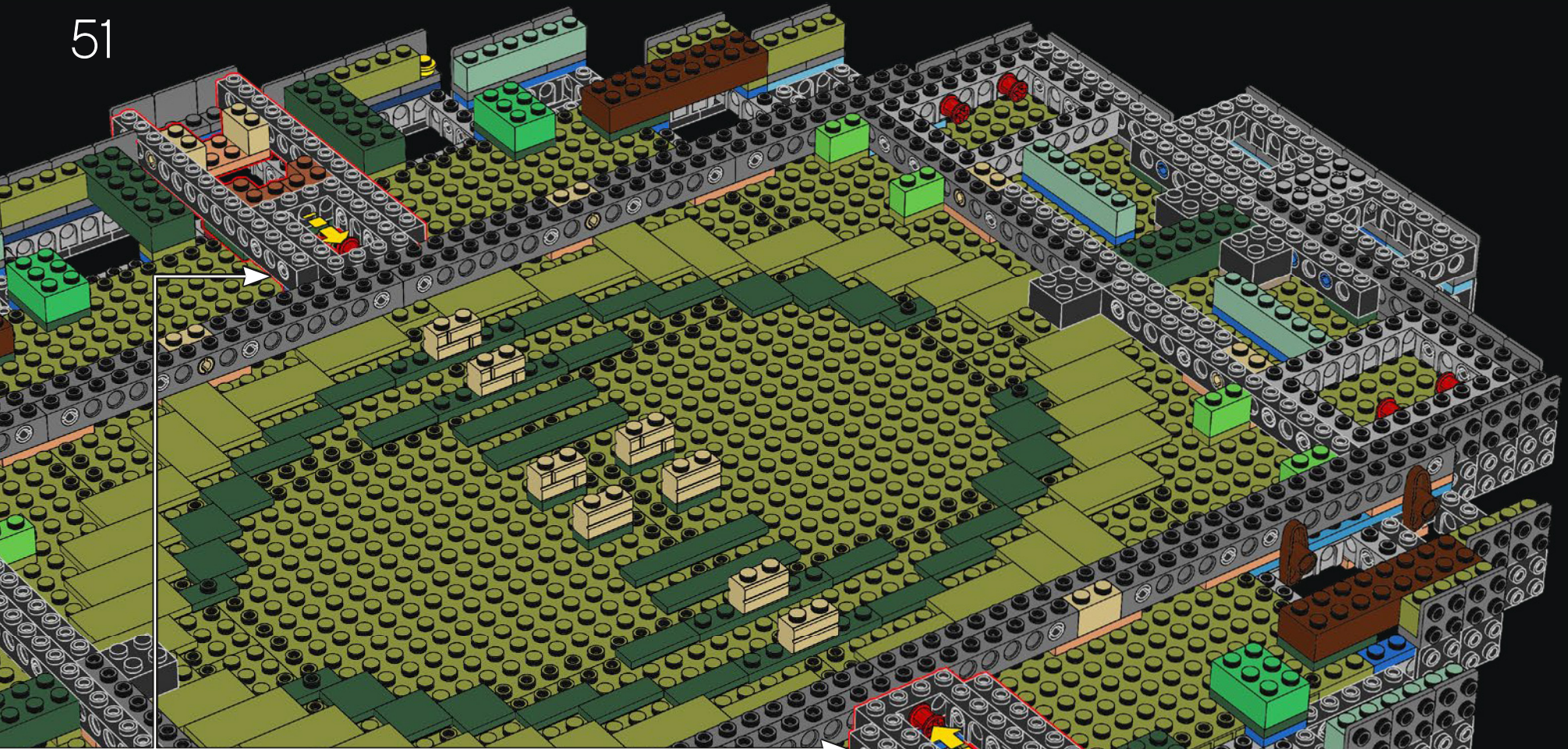



52

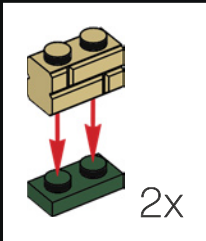
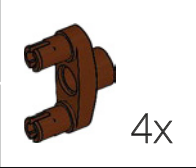

54

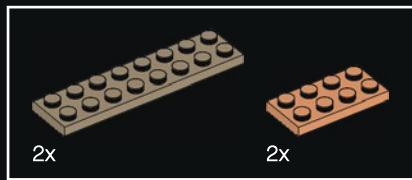

53

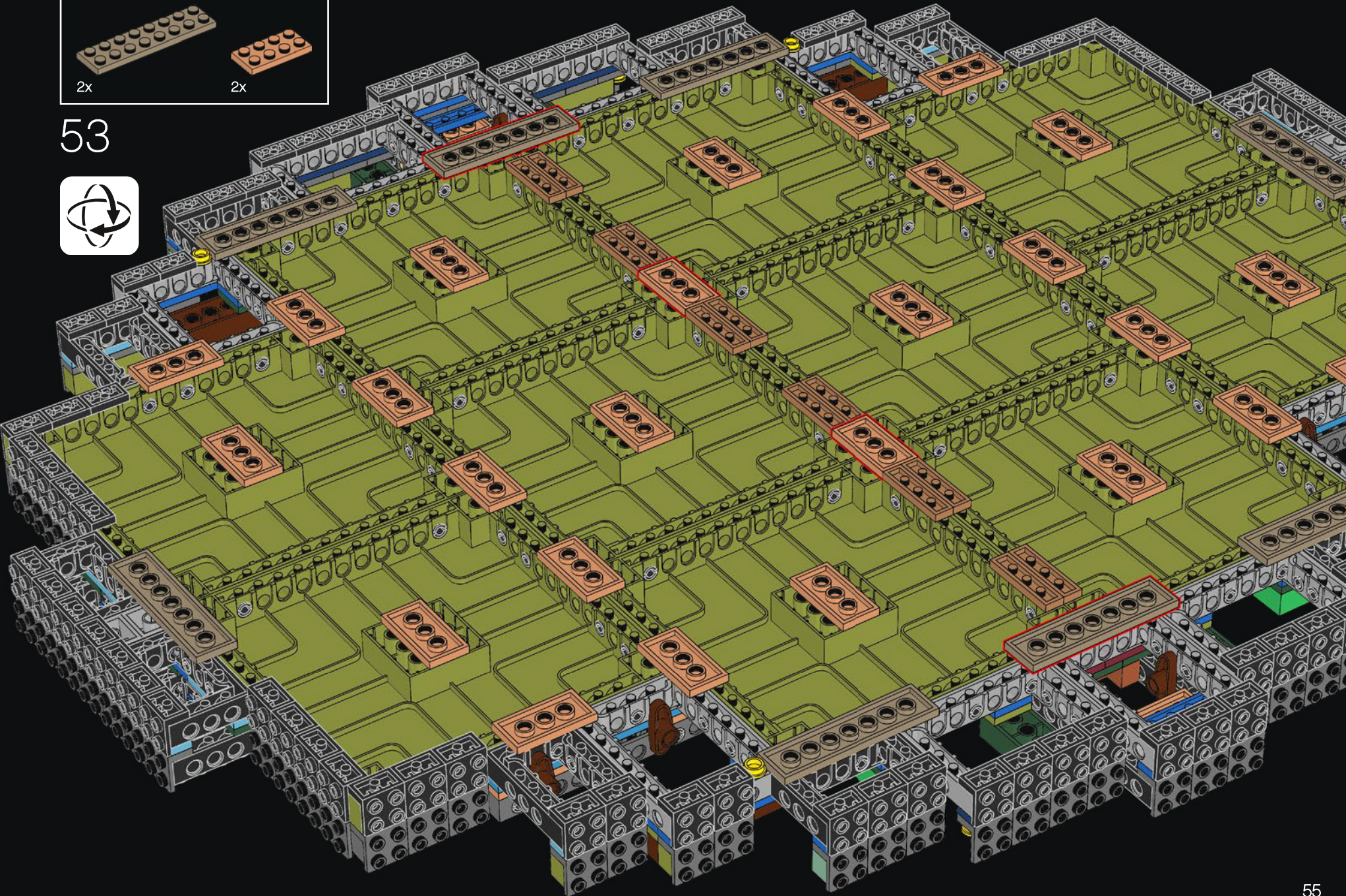



- 1x Yellow 1x6 Technic Brick
- 1x Red 1x6 Technic Brick
- 1x Yellow 1x3 Technic Brick
- 1x Red 1x3 Technic Brick
- 1x Blue 1x6 Technic Brick
- 1x Blue 1x4 Technic Brick
- 1x Blue 1x2 Technic Brick
- 1x White 1x6 Technic Brick
- 1x White 1x4 Technic Brick
- 1x White 1x2 Technic Brick

54



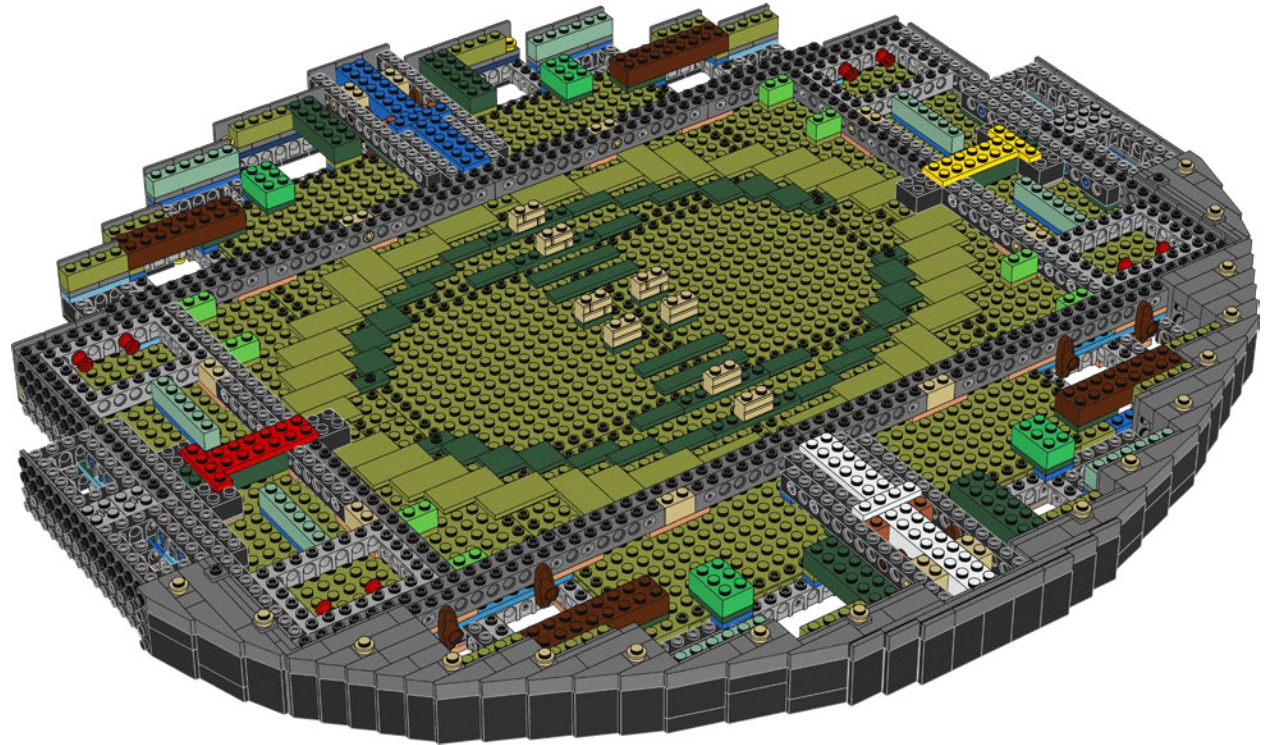
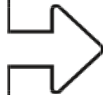

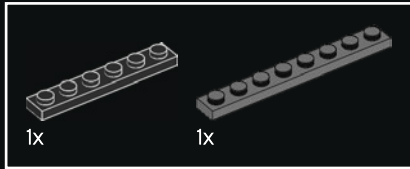
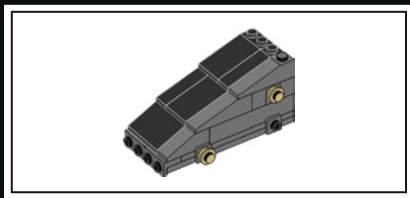

55

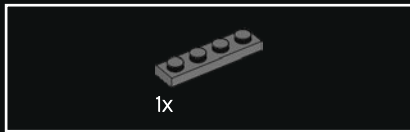
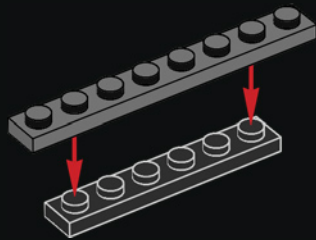

56

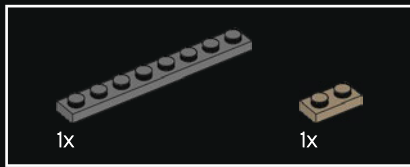
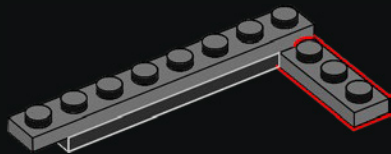

57

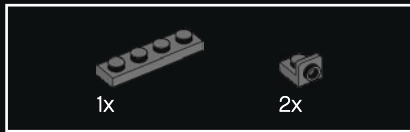
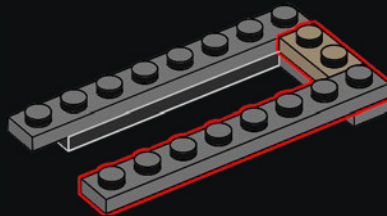

58

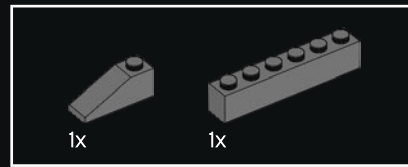
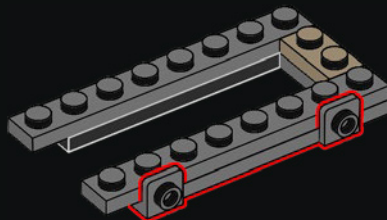

59

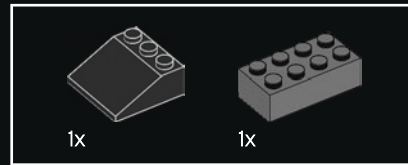
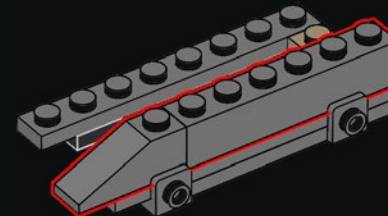

60

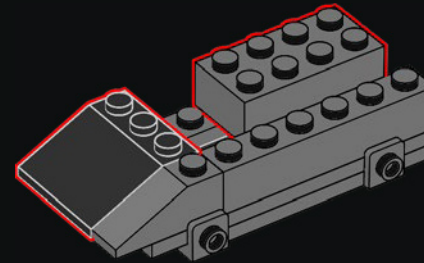

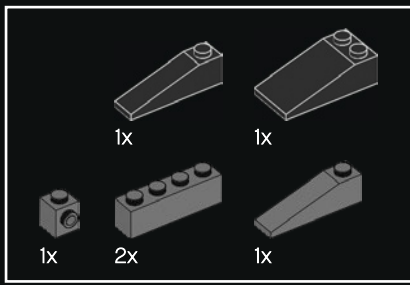

61

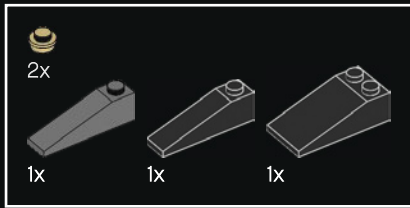
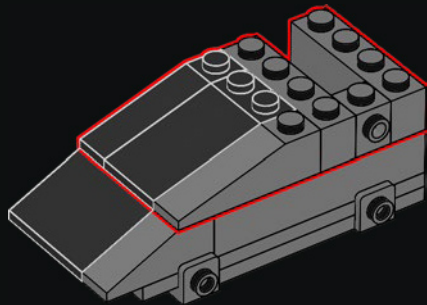

62

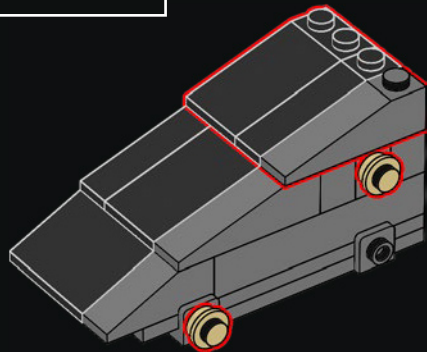

63

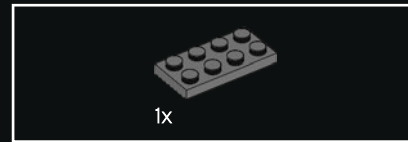
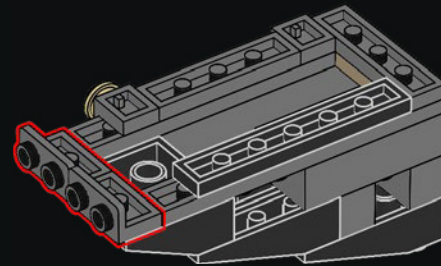

64

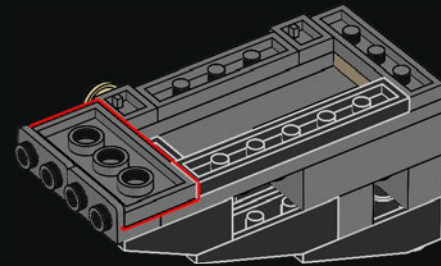

65

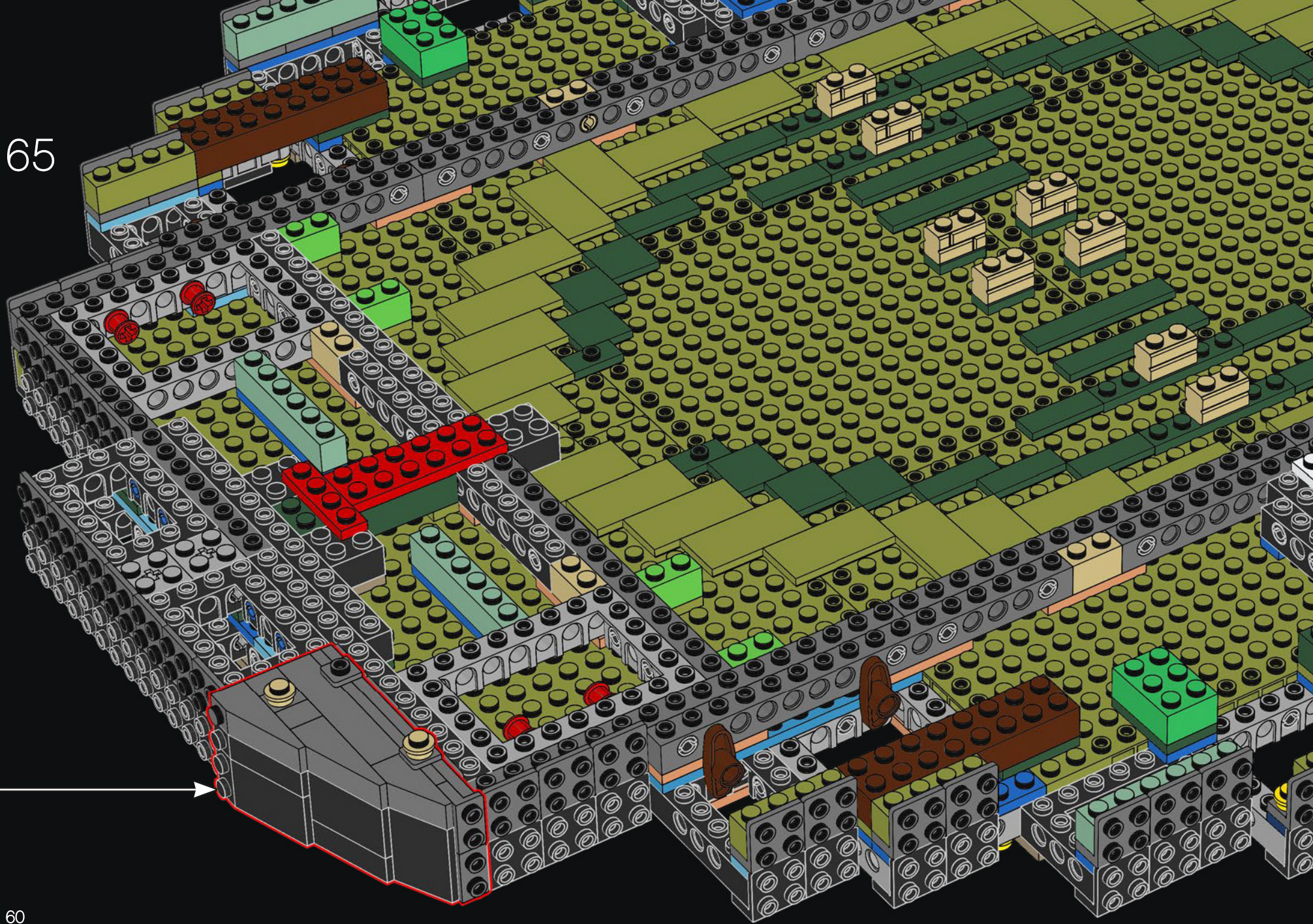

60

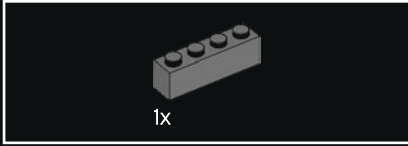
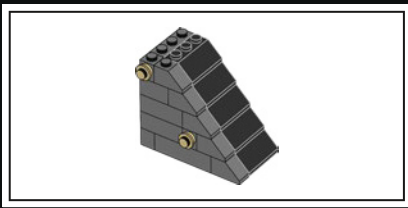

1x

66

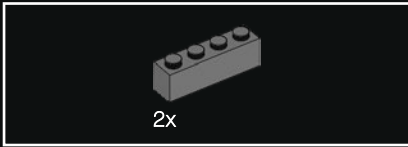

2x

67

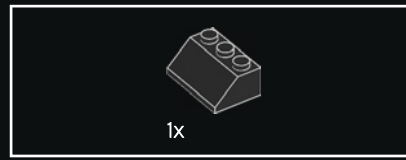
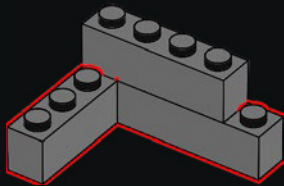

1x

68

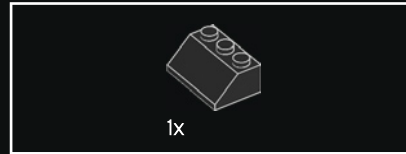
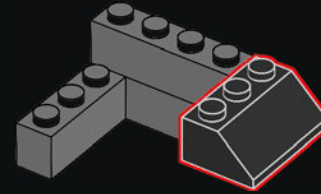

1x

69

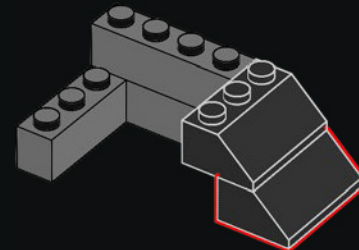

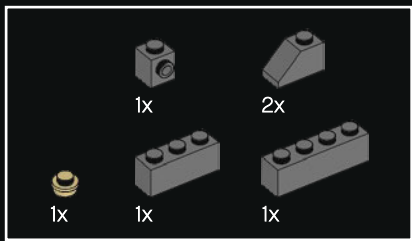

70

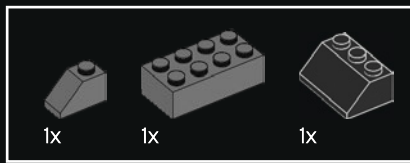
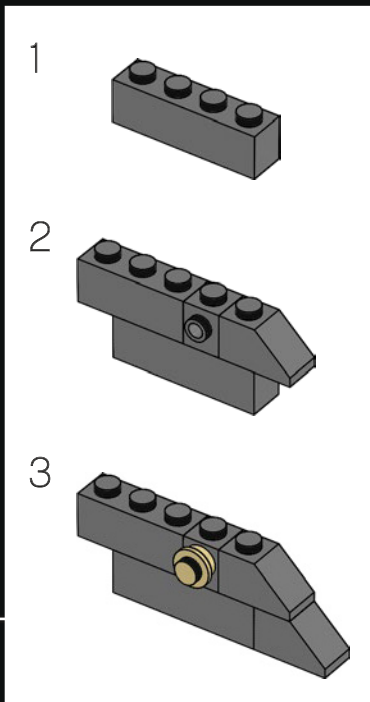
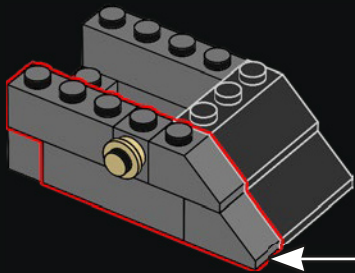

72

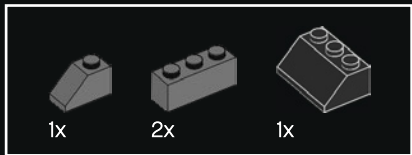
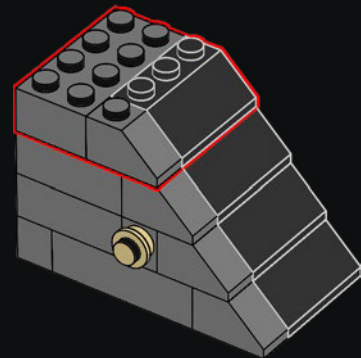

71

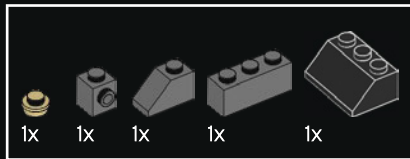
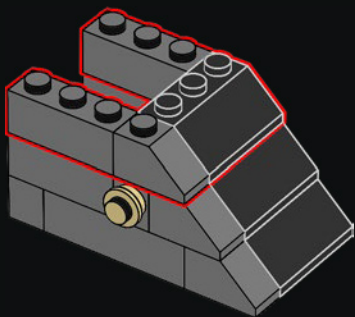

73

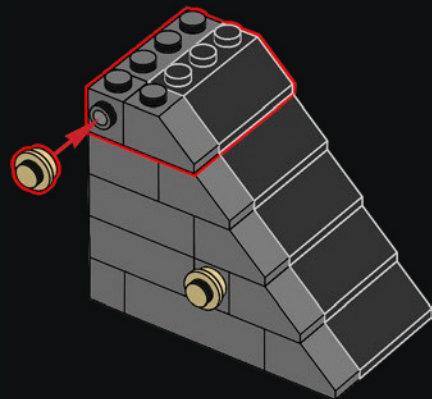

74

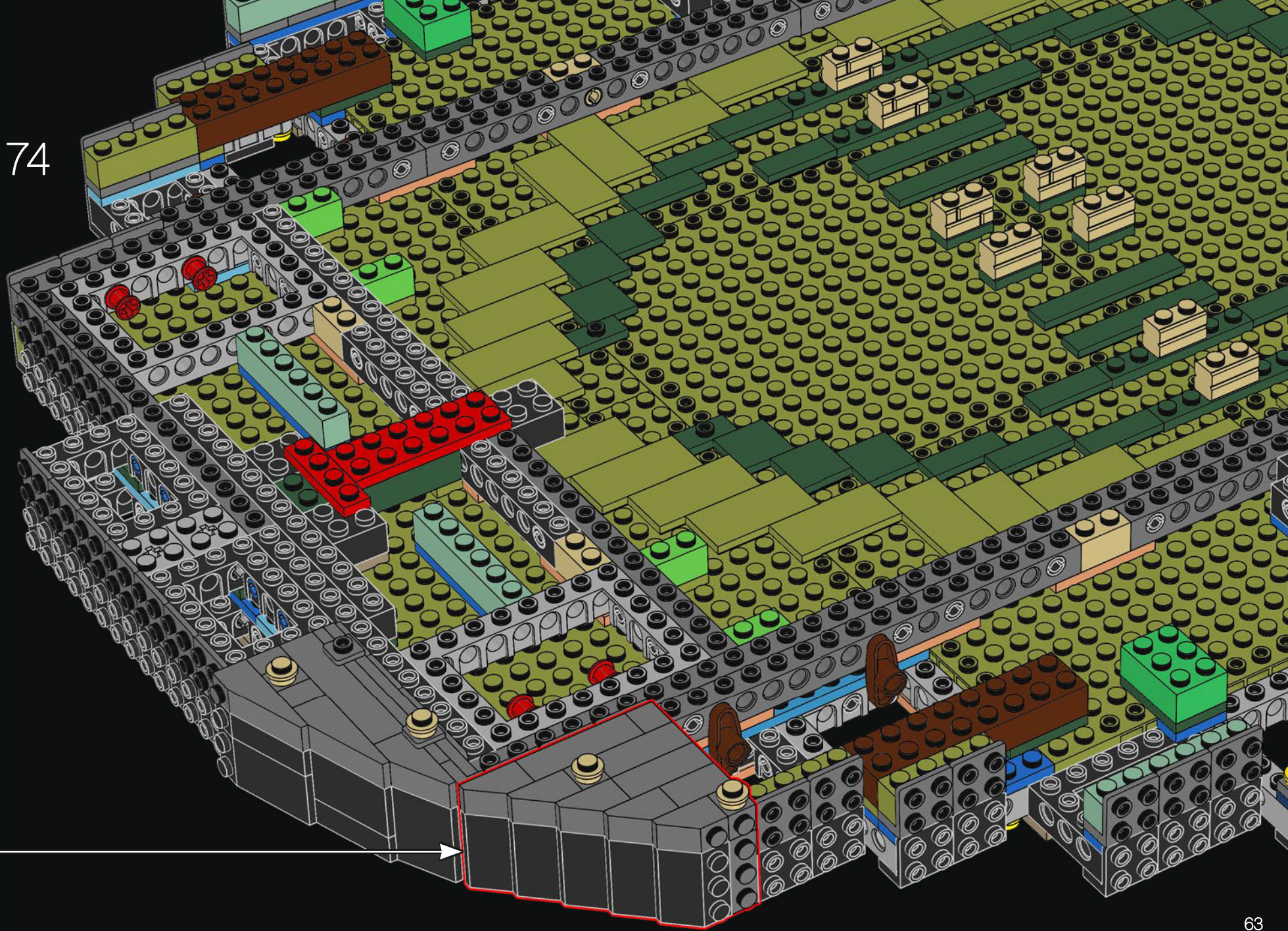

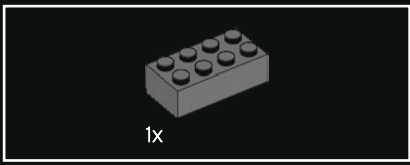

75

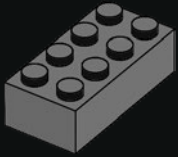

76

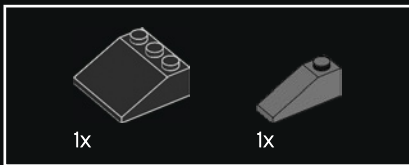
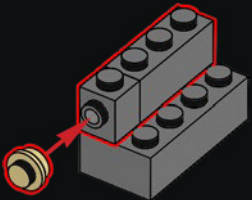

77

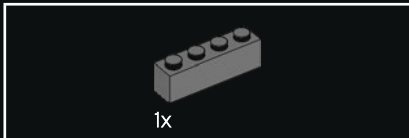
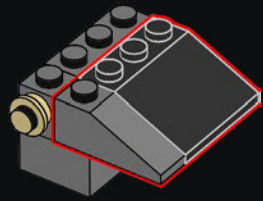

78

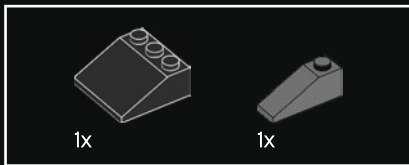
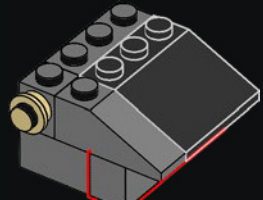

79

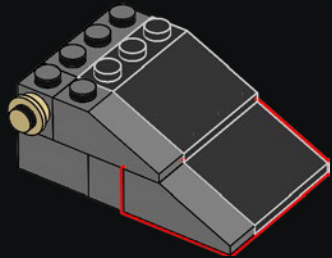

80

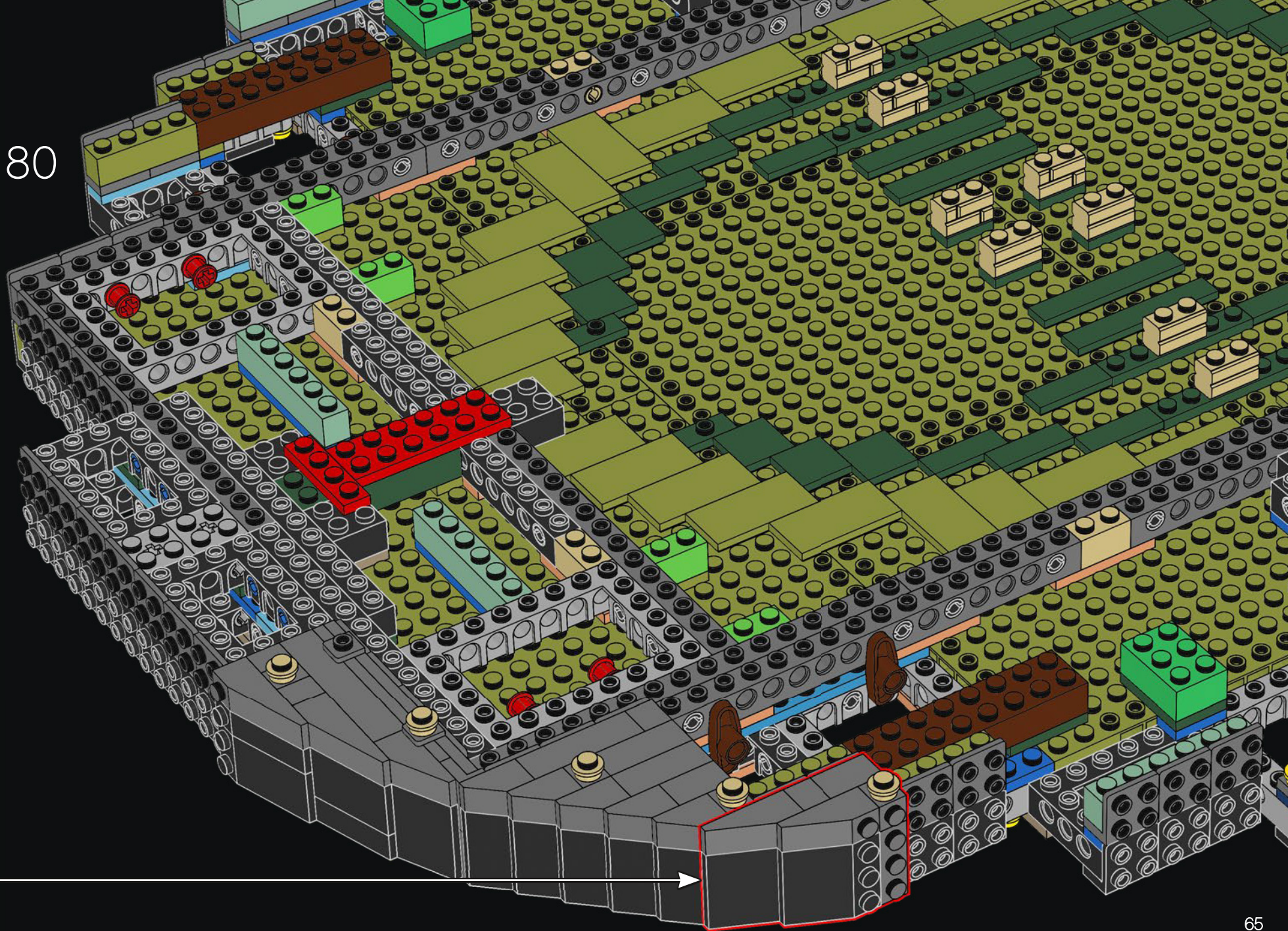

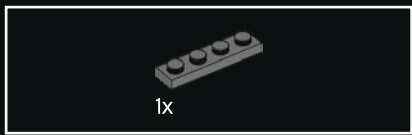

81

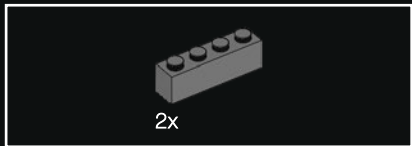

82

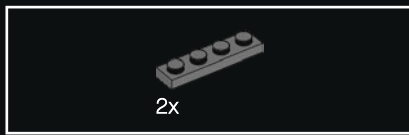
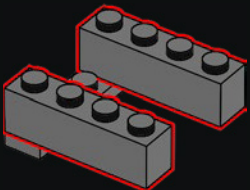

83

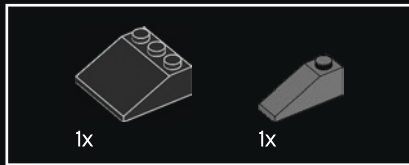
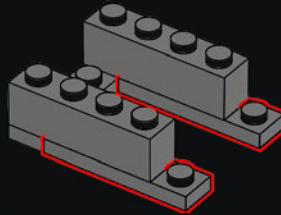

84

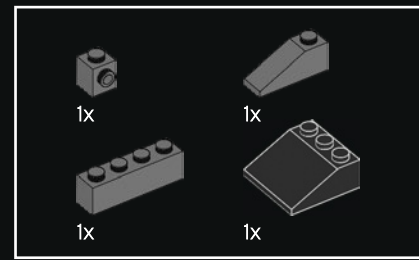
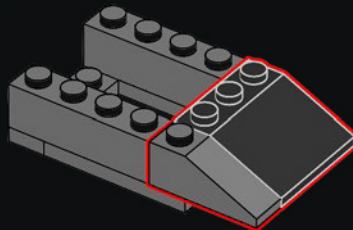

85

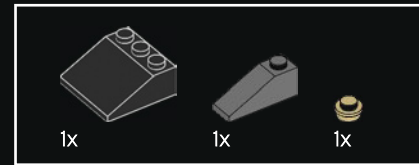
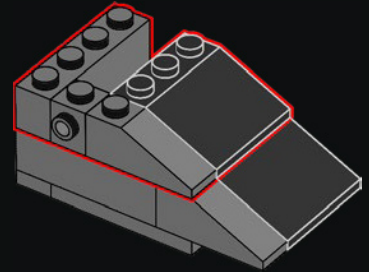

86

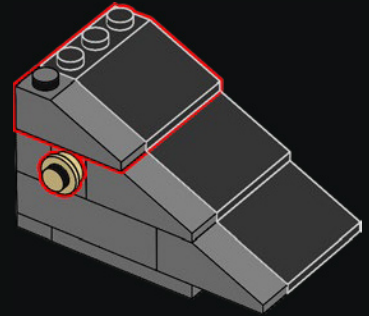

87



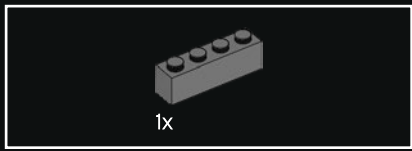

88

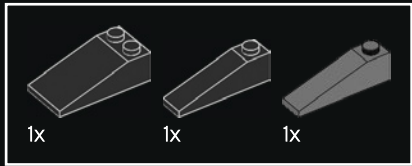
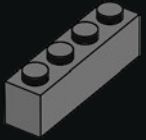

89

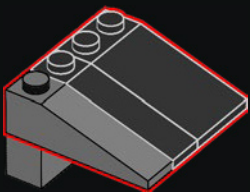

90

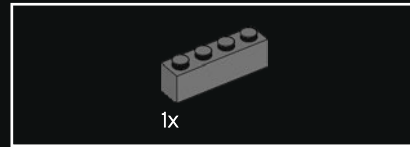
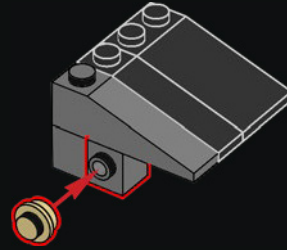

91

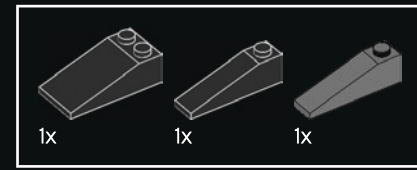
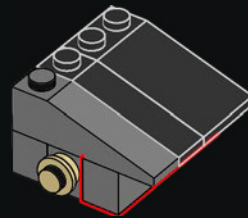

92

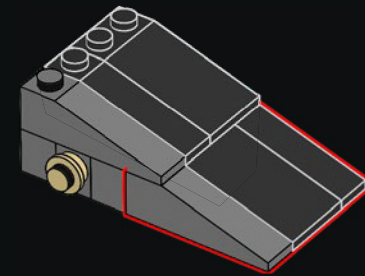

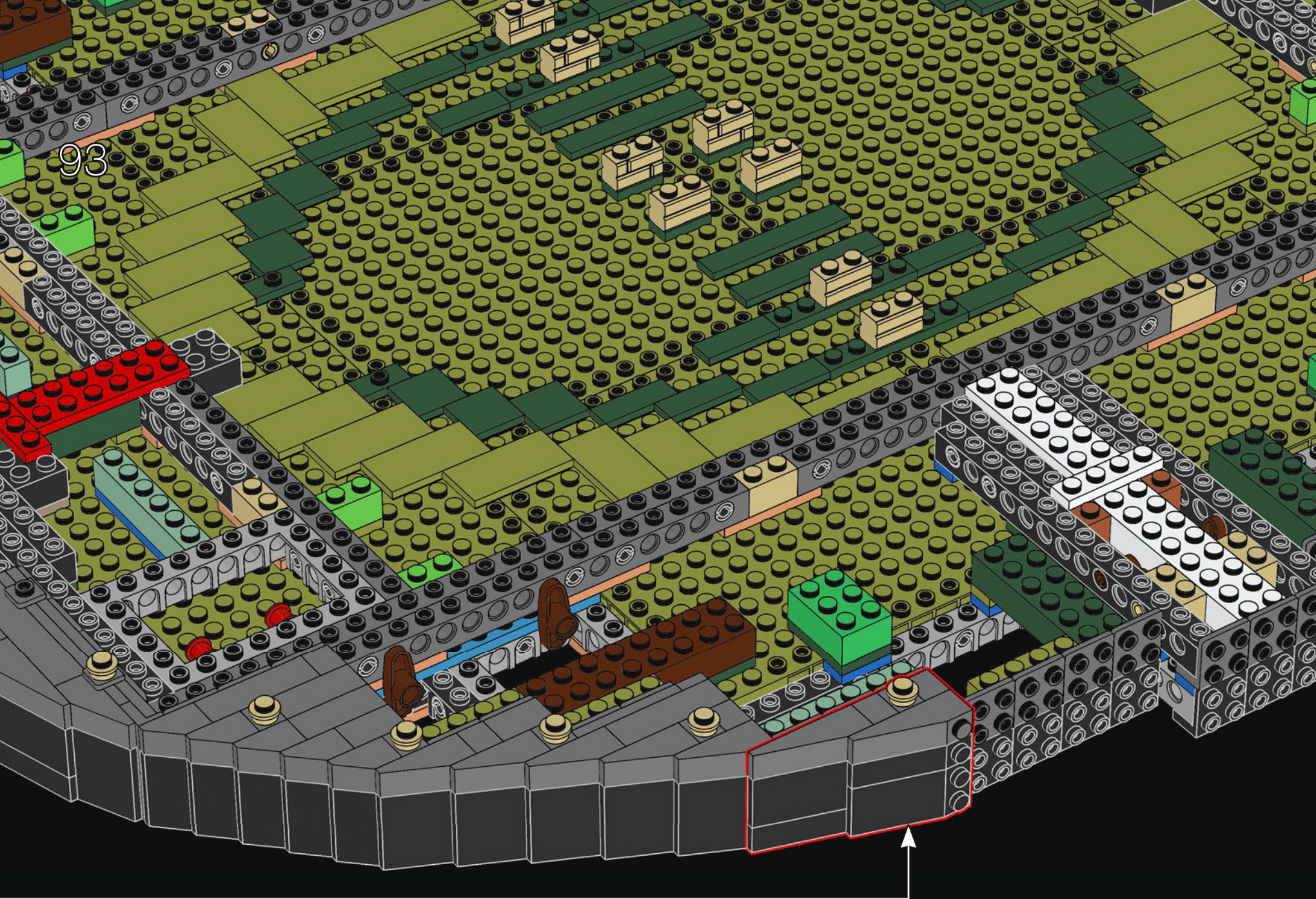

93

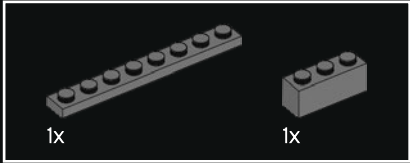
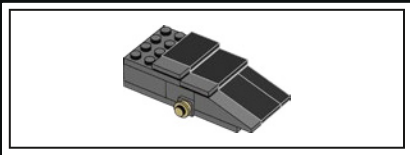

94

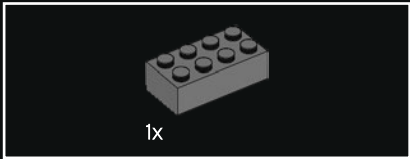
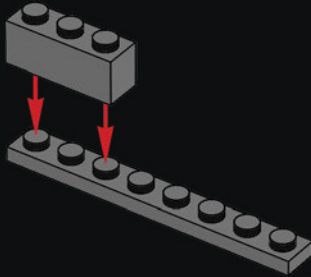

95

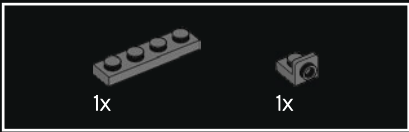
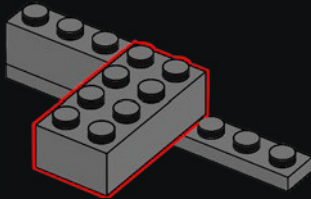

96

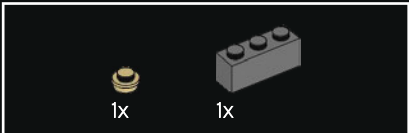
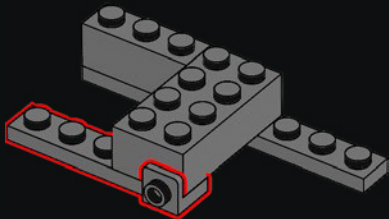

97

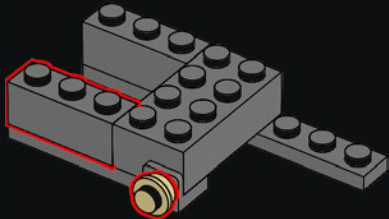

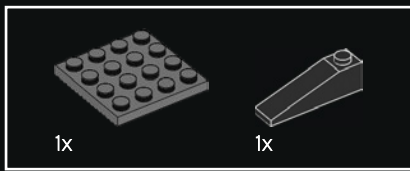

98

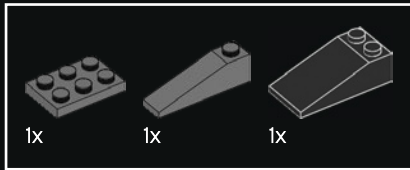
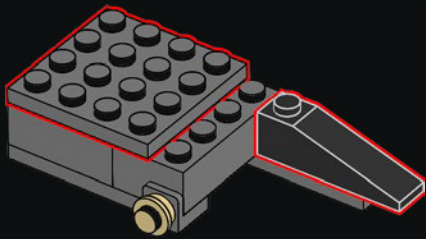

99

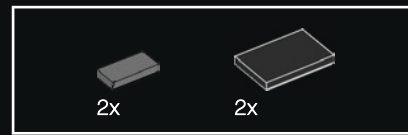
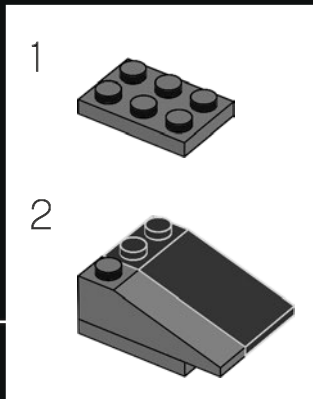
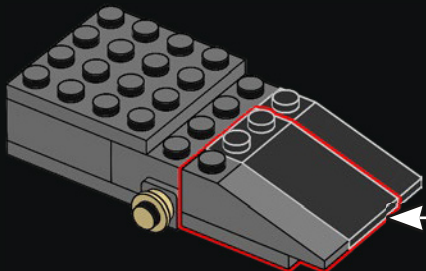

100

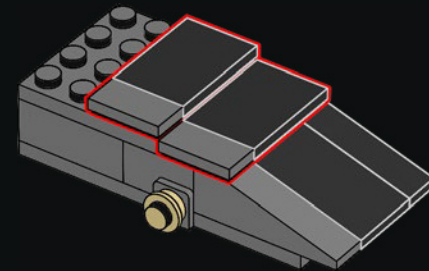

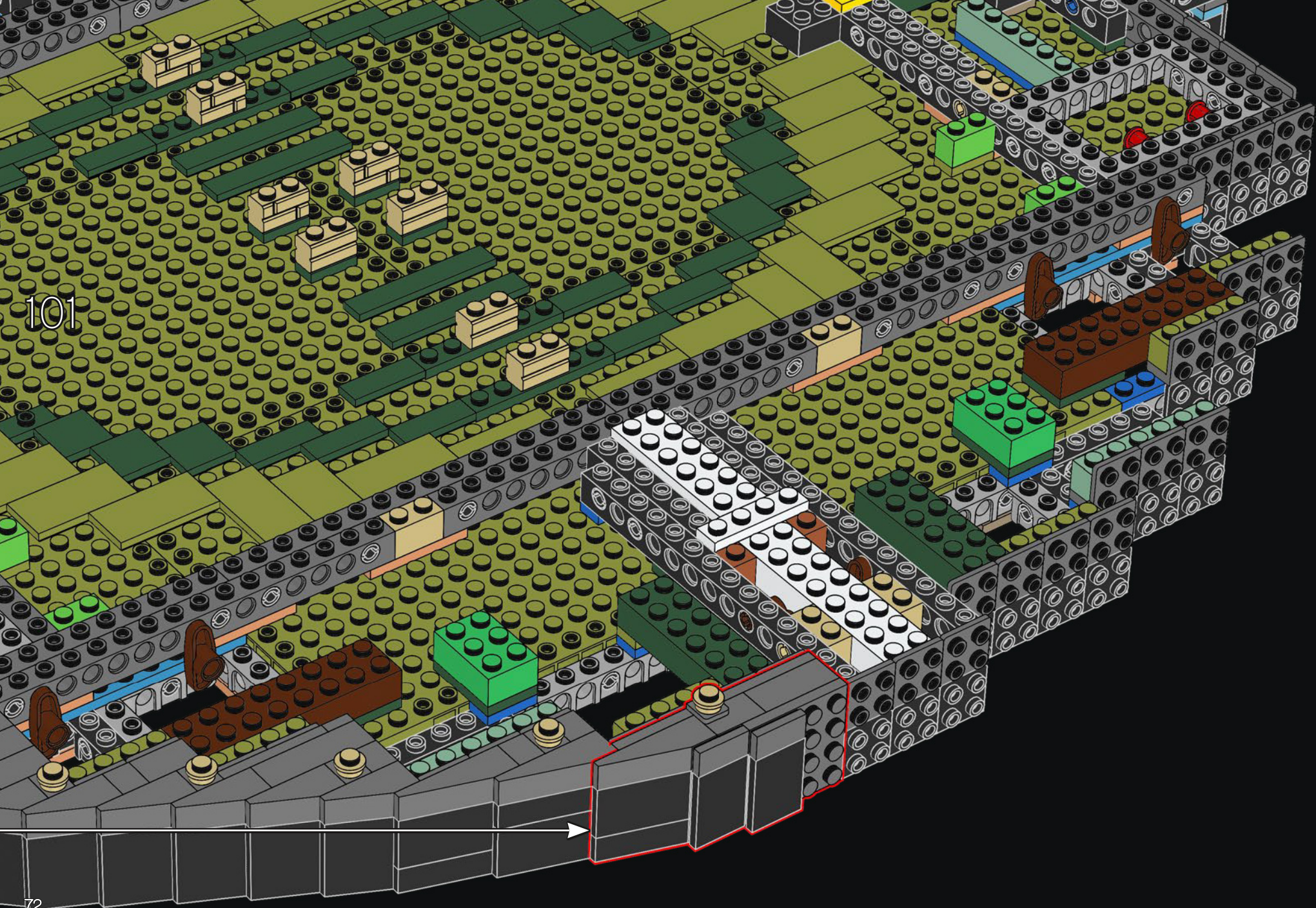

101

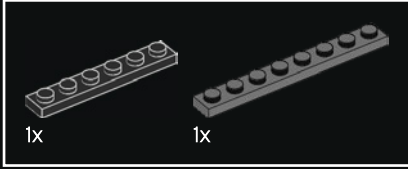
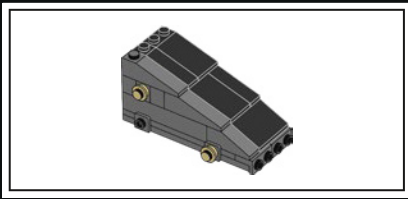

102

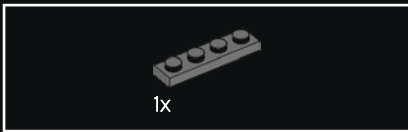
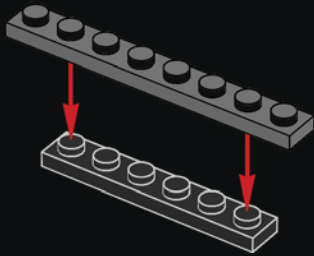

103

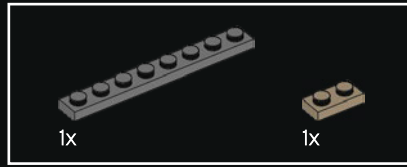
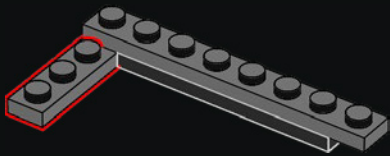

104

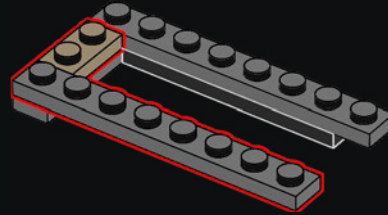

105

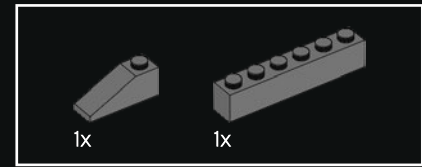
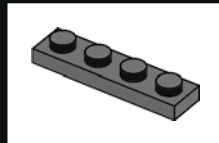
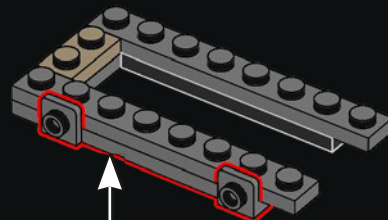

106

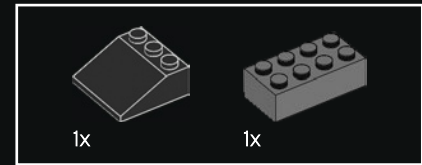
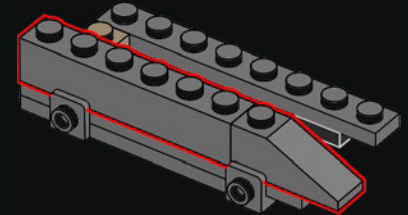

107

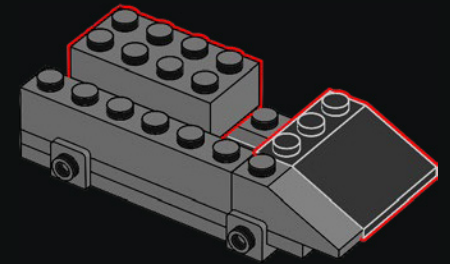

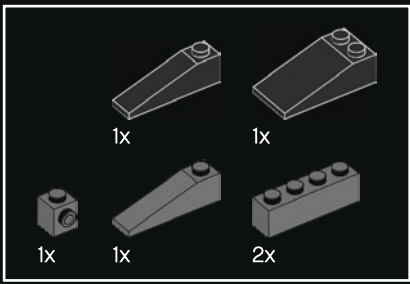

108

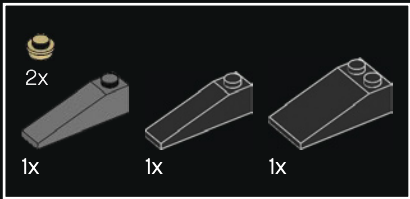
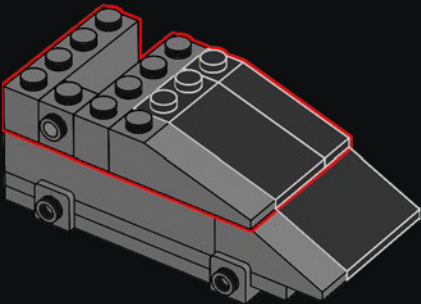

109

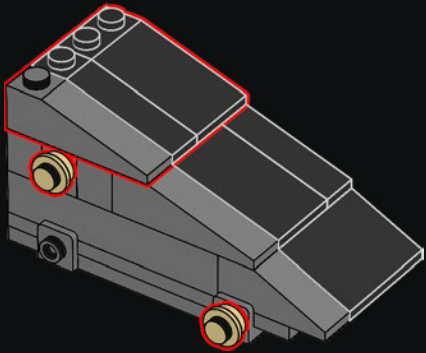

110

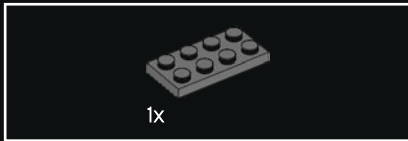
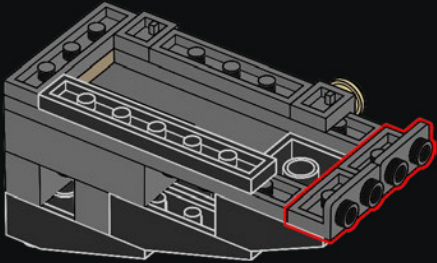

111

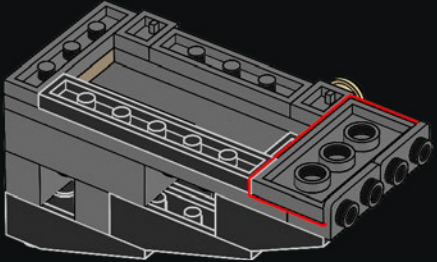

112



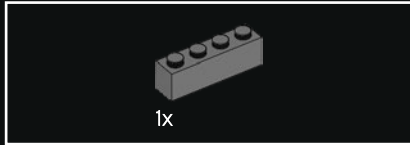
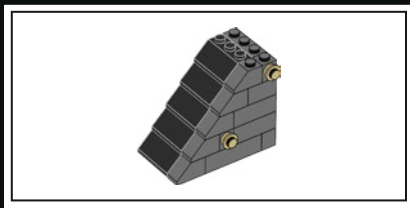

113

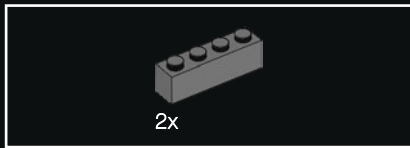
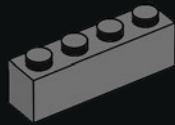

114

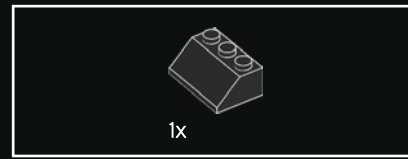
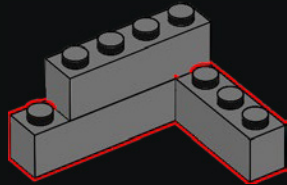

115

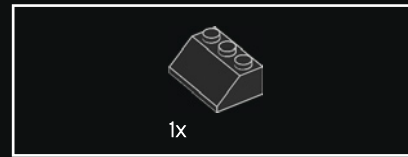
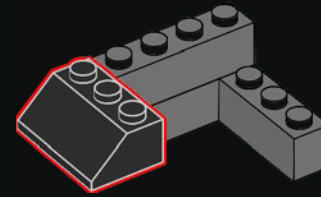

116

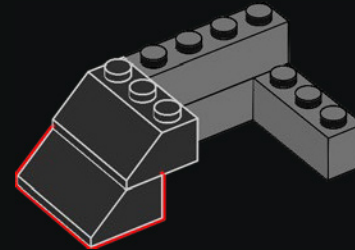

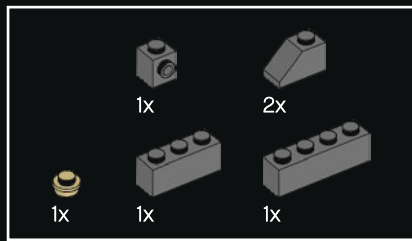

117

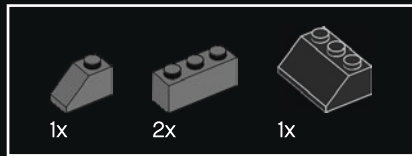
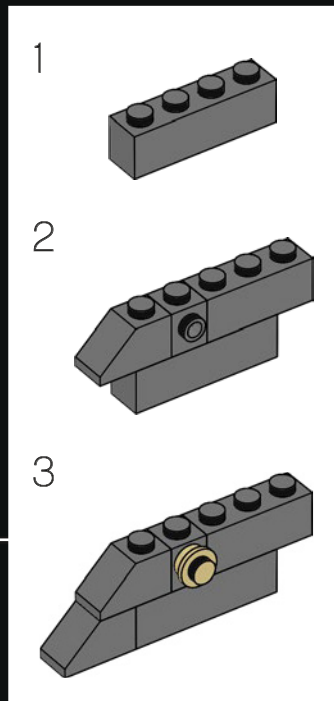
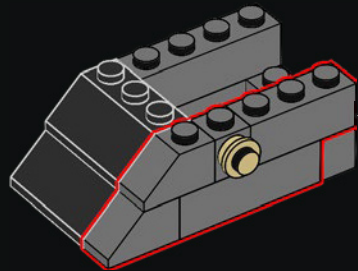

118

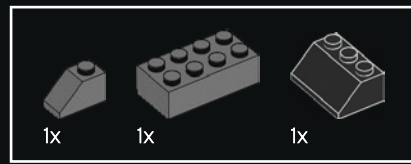
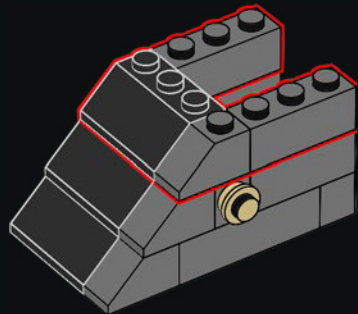

119

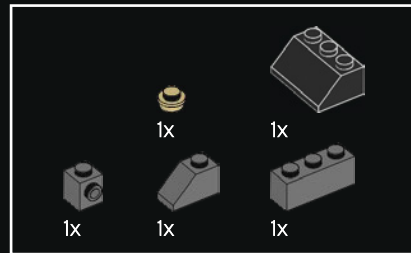
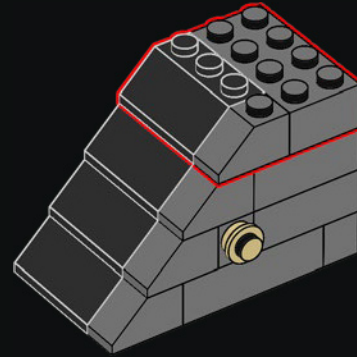

120

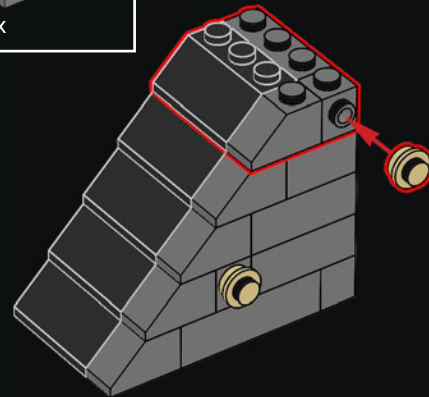



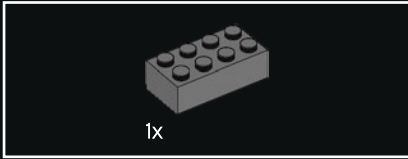
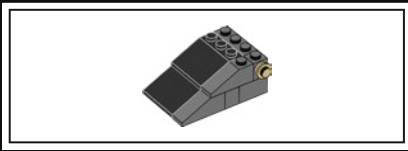

122

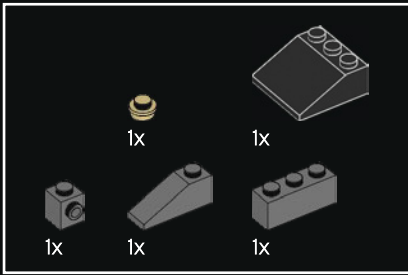
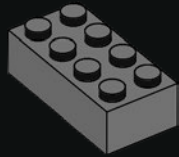

123

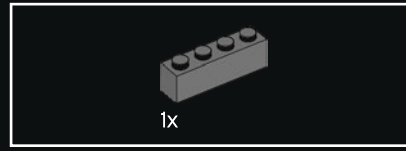
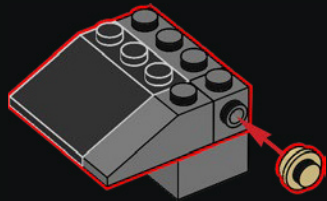

124

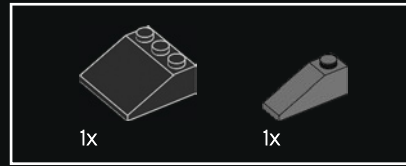
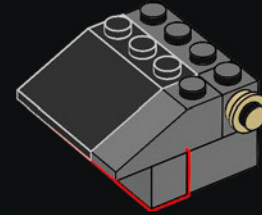

125

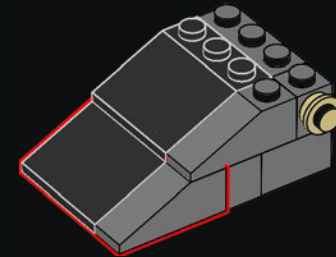

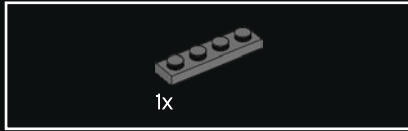
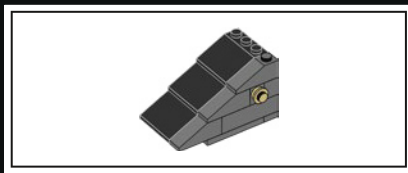

127

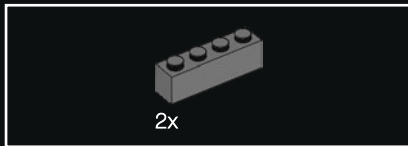

128

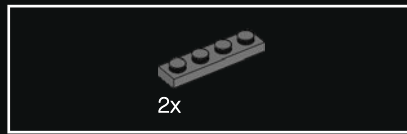
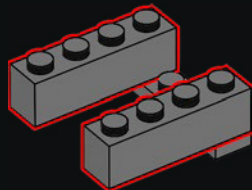

129

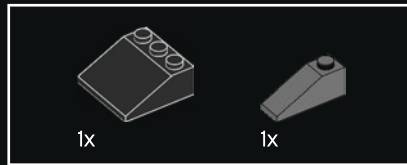
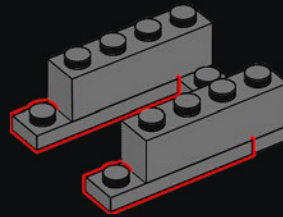

130

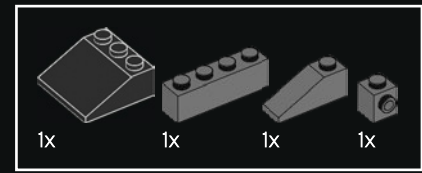
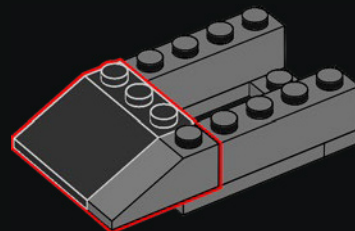

131

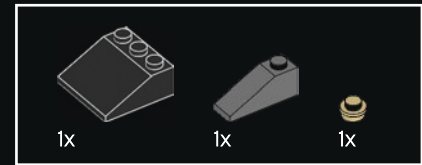
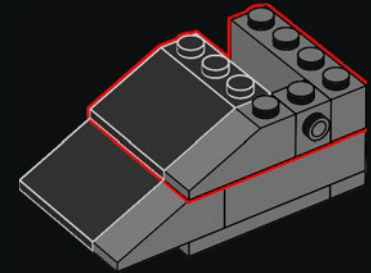

132

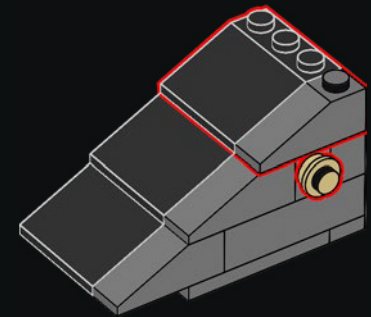



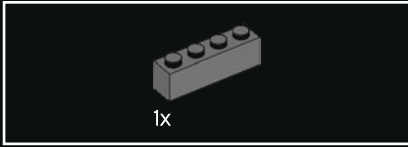
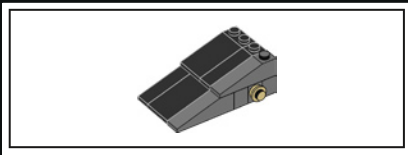

134

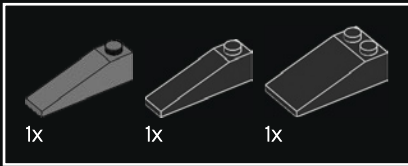
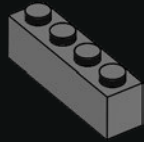

135

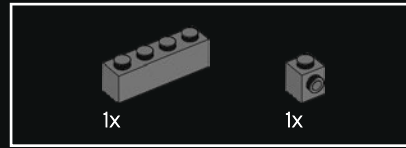
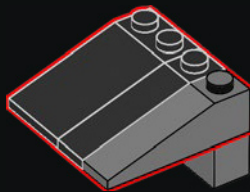

136

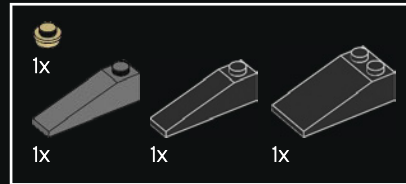
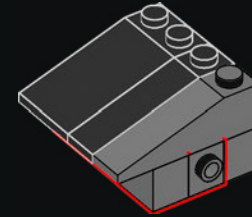

137

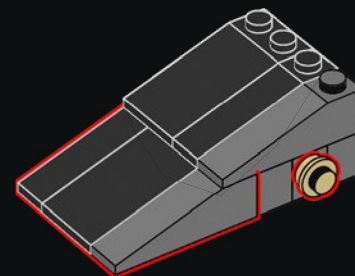



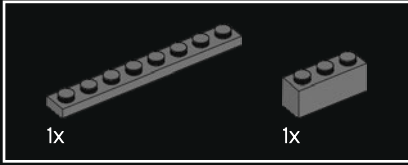
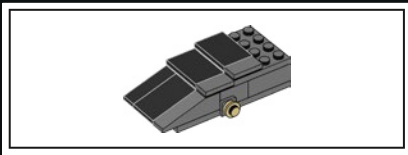

139

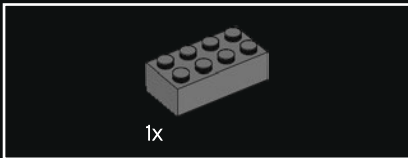
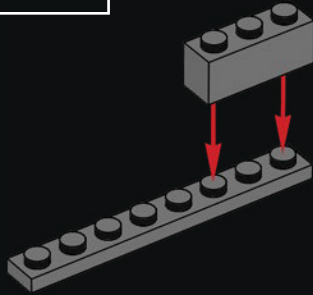

140

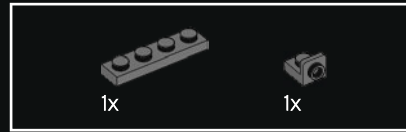
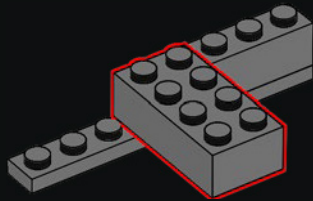

141

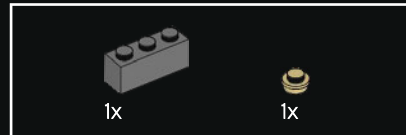
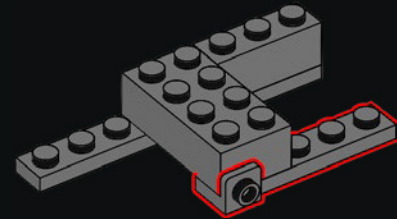

142

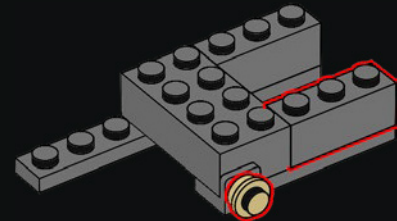

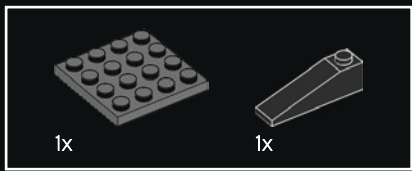

143

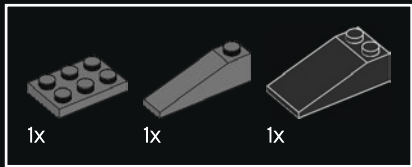
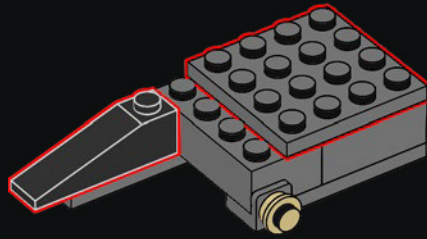

144

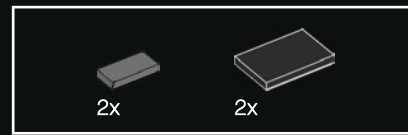
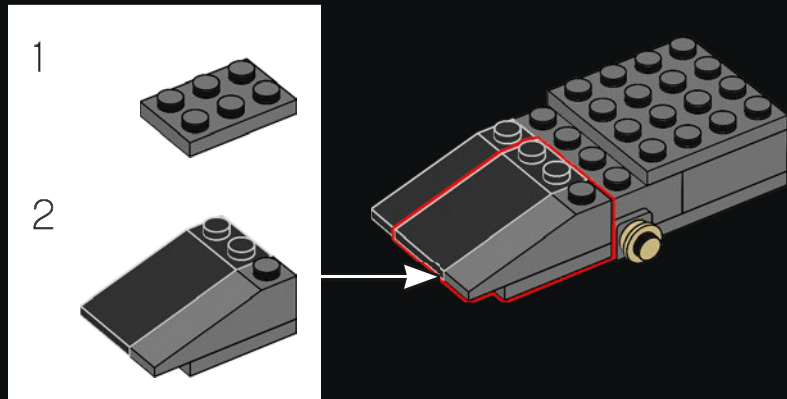

145

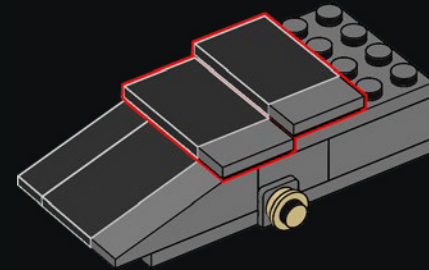

146

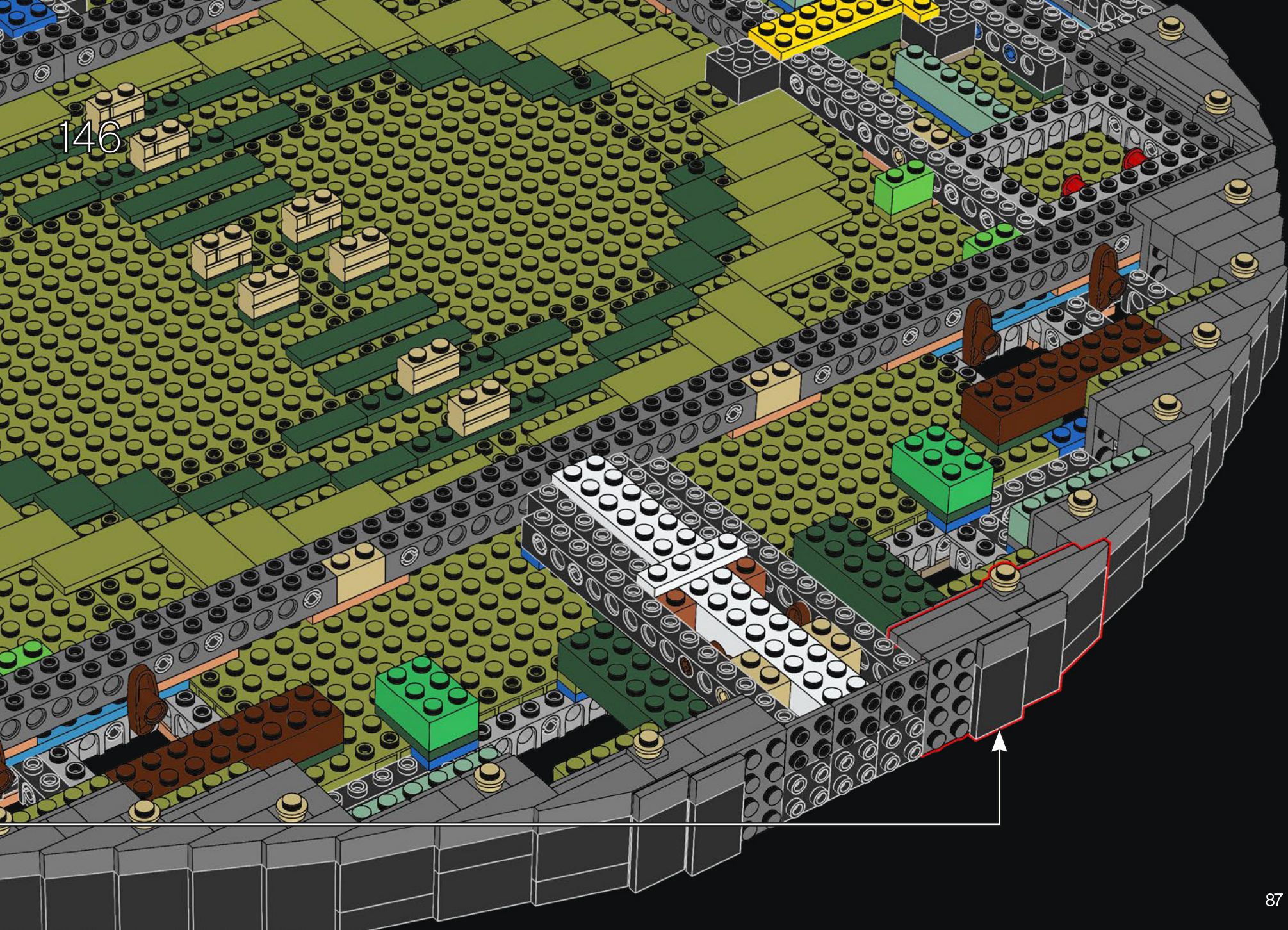

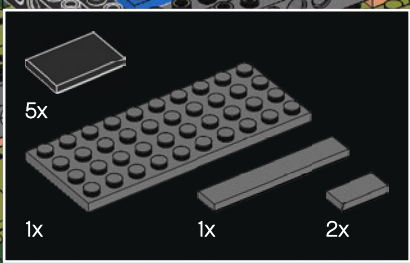

147

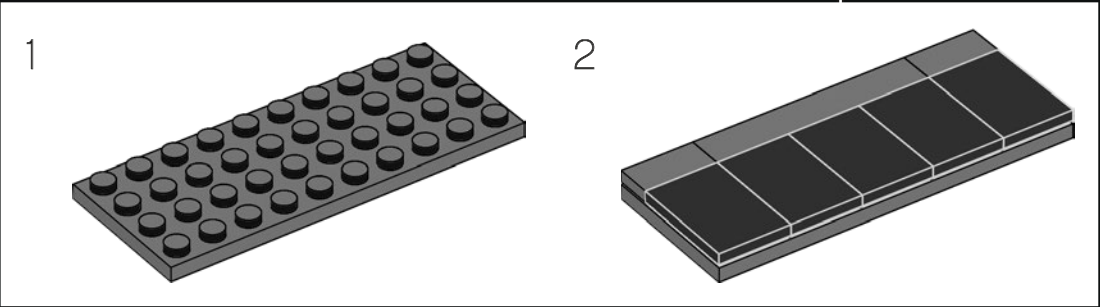

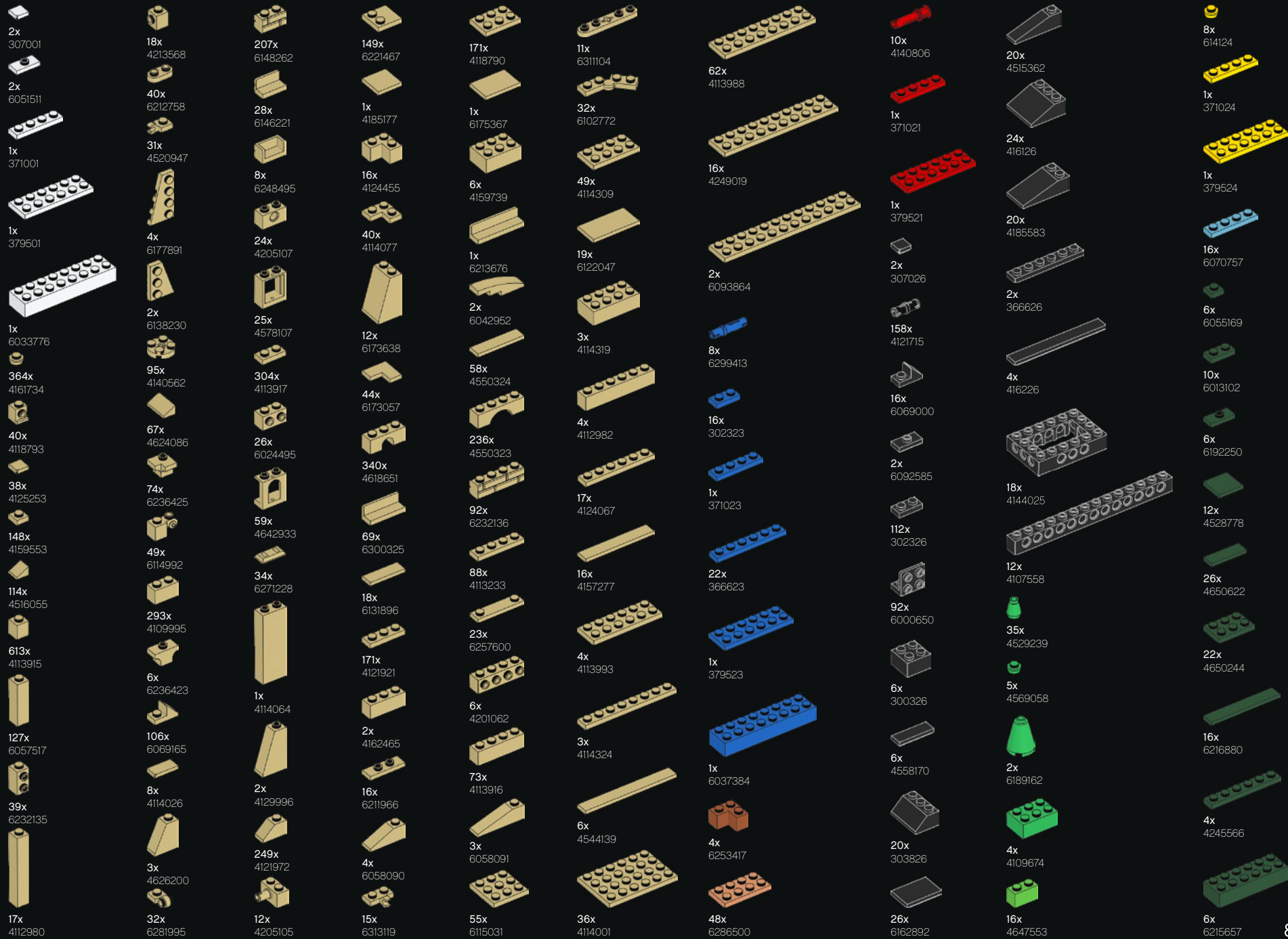

- 32x 6016483
- 10x 6212080
- 12x 6062697
- 36x 6016488
- 1x 6275877
- 1x 6195266
- 12x 6167700
- 1x 6240515

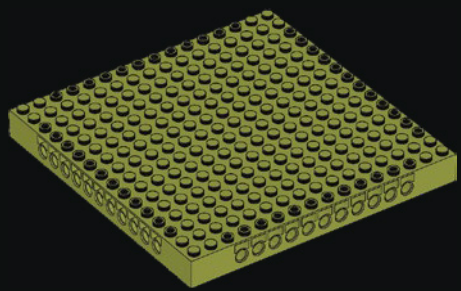

- 10x 6301768

- 115x 6300321
- 96x 6300320
- 133x 6300322
- 18x 6300318
- 36x 6055172
- 91x 4549436
- 14x 6040126
- 35x 6001824
- 239x 6231386
- 35x 6093064
- 142x 4528604
- 237x 6092591
- 35x 4521914
- 5x 4496699

- 17x 6167894
- 8x 4246957
- 115x 4530678
- 213x 4616711
- 36x 6047415
- 81x 4550168
- 40x 6184880
- 7x 6132768
- 14x 6015452
- 23x 6175927
- 23x 4626904
- 4x 4267874
- 1x 4507047
- 3x 6015424
- 1x 4550329
- 14x 6156492

- 56x 4530678
- 213x 4616711
- 36x 6047415
- 81x 4550168
- 40x 6184880
- 7x 6132768
- 14x 6015452
- 23x 6175927
- 23x 4626904
- 4x 4267874
- 1x 4507047
- 3x 6015424
- 1x 4550329
- 14x 6156492

- 19x 6039482
- 12x 4558955
- 6x 6225494
- 11x 6092572
- 79x 6039479
- 18x 4211052
- 20x 4211135
- 8x 6214341
- 92x 6308045
- 9x 6123814
- 8x 6126083
- 4x 4211094
- 2x 4211055
- 66x 4211104
- 24x 4211045
- 19x 6039482

- 12x 4558955
- 6x 6225494
- 11x 6092572
- 79x 6039479
- 18x 4211052
- 20x 4211135
- 8x 6214341
- 92x 6308045
- 9x 6123814
- 8x 6126083
- 4x 4211094
- 2x 4211055
- 66x 4211104
- 24x 4211045
- 19x 6039482

- 6x 4243831
- 18x 6187008
- 6x 4211043
- 48x 4211103
- 13x 6257592
- 24x 4211001
- 20x 4211053
- 20x 4535930
- 33x 4560184
- 2x 4211065
- 22x 4211085
- 4x 4211100
- 22x 4210651
- 6x 4243831

- 18x 6187008
- 6x 4211043
- 48x 4211103
- 13x 6257592
- 24x 4211001
- 20x 4211053
- 20x 4535930
- 33x 4560184
- 2x 4211065
- 22x 4211085
- 4x 4211100
- 22x 4210651
- 6x 4243831

- 4x 4211752
- 16x 4210998
- 2x 4210997
- 28x 6147337
- 2x 4211122
- 2x 6000970
- 18x 4256828
- 4x 6250216
- 4x 6151666
- 8x 6177081
- 4x 4539076

- 16x 4210998
- 2x 4210997
- 28x 6147337
- 2x 4211122
- 2x 6000970
- 18x 4256828
- 4x 6250216
- 4x 6151666
- 8x 6177081
- 4x 4539076

- 14x 4211848
- 1x 6170468
- 12x 6323704
- 11x 6116613
- 4x 6096701
- 20x 6168647
- 6x 4211399
- 75x 6043656
- 4x 6273227
- 9x 6043639
- 126x 6211969
- 8x 4211752

- 1x 6170468
- 12x 6323704
- 11x 6116613
- 4x 6096701
- 20x 6168647
- 6x 4211399
- 75x 6043656
- 4x 6273227
- 9x 6043639
- 126x 6211969
- 8x 4211752

- 14x 4211848



Customer Service
Kundenservice
Service Consommateurs
Servicio Al Consumidor

LEGO.com/service or dial

00800 5346 5555 : 

1-800-422-5346 : 





FEEDBACK AND WIN



FEEDBACK AND WIN

Your feedback will help shape the future development of this product series.

Please visit:

FEEDBACK UND GEWINNEN

Dein Feedback trägt zur Weiterentwicklung dieser Produktreihe bei.

Geh auf:

COMMENTEZ ET GAGNEZ

Vos commentaires nous aideront à concevoir les futurs produits de cette gamme.

Rendez-vous sur :

COMENTA Y GANA

Tu opinión nos ayudará a dar forma al desarrollo de esta serie de productos en el futuro.

Visita:

反馈有奖

您的反馈将有助于我们在今后改进本系列产品。

请访问：

[LEGO.com/productfeedback](https://www.lego.com/productfeedback)

By completing, you will automatically enter a drawing to win a LEGO® set.

Terms & Conditions apply.

Durch Ausfüllen nimmst du automatisch an der Verlosung eines LEGO® Preises teil.

Es gelten die Teilnahmebedingungen.

En envoyant vos commentaires, vous serez automatiquement inscrit(e) à un tirage au sort qui vous permettra de remporter un prix LEGO®.

Offre soumise à conditions.

Al contestar, participarás automáticamente en el sorteo y podrás ganar un set LEGO®.

Sujeto a Términos y Condiciones.

完成我们的反馈调查，即可自动进入抽奖环节，赢取乐高®套装。

适用《条款和条件》。

